

# Proceedings of

**The 7<sup>th</sup> Indonesia Japan Joint Scientific Symposium**

**The 24<sup>th</sup> CEReS International Symposium**

**The 4<sup>th</sup> Symposium on Microsatellite for Remote Sensing (SOMIRES 2016)**

**The 1<sup>st</sup> Symposium on Innovative Microwave Remote Sensing**

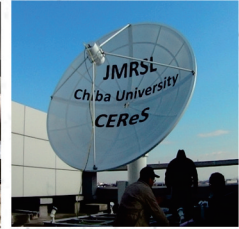
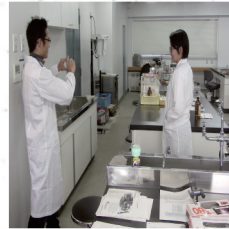
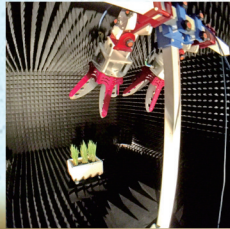

**November 21-24, 2016**

**Keyaki Convention Hall, Chiba University**

## Organizers

Center for Environment Remote Sensing, Chiba University, Japan

Sister Universities of Chiba University

(UI, IPB, ITB, Unpad, UGM, Undip, ITS, Unud, Unhas, UNS, UIR, BMKG)



The 7th Indonesia Japan  
Joint Scientific Symposium  
(IJSS 2016)  
Chiba, 20-24 November 2016

---

Preface

The 7<sup>th</sup> Indonesia Japan Joint Scientific Symposium (IJSS 2016), the 24<sup>th</sup> CEReS International Symposium, the 4<sup>th</sup> Symposium on Microsatellite for Remote Sensing (SOMIRES), and the Symposium on Innovative Microwave Remote Sensing were held on the Nishi-Chiba campus of Chiba University, Japan, during 20-24 November 2016. These symposia focused on providing a forum to share and discuss recent issues and developments in various fields of science and technology.

IJSS has been held since 2004 and now it has become one of the successful regional symposia co-organized by two countries – Indonesia and Japan. In IJSS 2016, a total of 160 papers that have gone through review process are presented. In each of the 29 sessions, enthusiastic and stimulating discussions have led to the exchange of innovative ideas and advancement of the state of knowledge among students and researchers from universities in Japan, Indonesia, and other countries.

Generous supports for the conference were provided by Kabupaten Siak, Bank RiauKepri, Katoro, APPJ, Dental Support, Chiba Soy Sauce Union, and Kominato Railway. On behalf of the IJSS local organizing team, I would like to express my sincere gratitude to their supports, which greatly contributed to the participation of young scientists.

Finally, I would like to thank all the proceedings team members who have dedicated their effort and time to bring the manuscripts into the form of a book. This book will serve as a long-lasting credit to the achievements of IJSS 2016.

Professor Hiroaki Kuze, Dr. Sc.,

General Chairman of IJSS 2016



## Committees

### Advisory Committee:

Prof. Takeshi Tokuhsa, President of Chiba University, Japan  
Prof. Muhammad Anis, Rector of Universitas Indonesia, Indonesia

### General Chairman

Prof. Hiroaki Kuze

### Executive Committee

Prof. Andi Eka Sakya, Head of Badan Meteorologi, Klimatologi, dan Geofisika, Indonesia  
Prof. Herry Suhardiyanto, Rector of Institut Pertanian Bogor, Indonesia  
Prof. Kadarsah Suryadi, Rector of Institut Teknologi Bandung, Indonesia  
Prof. Yos Johan Utama, Rector of Universitas Diponegoro, Indonesia  
Prof. Dwikorita Karnawati, Rector of Universitas Gadjah Mada, Indonesia  
Prof. Dwia Aries Tina Pulubuhu, Rector of Universitas Hasanuddin, Indonesia  
Prof. Muhammad Anis, Rector of Universitas Indonesia, Indonesia  
Prof. Tri Hanggono Achmad, Rector of Universitas Padjadjaran, Indonesia  
Prof. Ketut Suastika, Rector of Universitas Udayana, Indonesia  
Prof. H. Detri Karya, Rector of Universitas Islam Riau, Indonesia  
Prof. Ravik Karsidi, Rector of Universitas Sebelas Maret, Indonesia

### Sister Universities (\*)

Badan Meteorologi, Klimatologi, dan Geofisika, Indonesia  
Institut Pertanian Bogor, Indonesia  
Institut Teknologi Bandung, Indonesia  
Universitas Diponegoro, Indonesia  
Universitas Gadjah Mada, Indonesia  
Universitas Hasanuddin, Indonesia  
Universitas Indonesia, Indonesia  
Universitas Padjajaran, Indonesia  
Universitas Udayana, Indonesia

\* Base on alphabet queue

### Organizing Committee

Prof. Hiroaki Kuze, Chiba University, Japan  
Prof. Kenichi Sakakibara, Chiba University, Japan  
Prof. Josaphat Tetuko Sri Sumantyo, Chiba University, Japan  
Prof. Shogo Shimazu, Chiba University, Japan  
Prof. Niikura Ryoko, Chiba University, Japan  
Prof. M. Takagaki, Chiba University, Japan  
Prof. Hiroshi Nakagawa, Chiba University, Japan  
Prof. Hitoshi Asanuma, Chiba University, Japan  
Prof. Ryutaro Tateishi, Chiba University, Japan  
Prof. Koichi Ito, Chiba University, Japan  
Prof. Kenzo Nonami, Chiba University, Japan  
Prof. Katsumi Hattori, Chiba University, Japan  
Prof. Gunawan Wibisono, Universitas Indonesia, Indonesia  
Prof. Eko Tjipto Rahardjo, Universitas Indonesia, Indonesia  
Prof. Danang Sri Hadmoko, Universitas Gadjah Mada, Indonesia  
Prof. Arif Marfai, Universitas Gadjah Mada, Indonesia  
Prof. Muhammad Asvial, Universitas Indonesia, Indonesia



**The 7th Indonesia Japan  
Joint Scientific Symposium  
(IJSS 2016)  
Chiba, 20-24 November 2016**

---

Prof. Ketut Wikantika, Institut Teknologi Bandung, Indonesia  
Prof. I Made Mahendra, Universitas Udayana, Indonesia  
Prof. Darsono, Universitas Sebelas Maret, Indonesia  
Prof. Edison Munaf, Universitas Andalas, Indonesia  
Prof. Nelson Pomalingo, Universitas Muhammadiyah Gorontalo, Indonesia  
Prof. Ohneda Osamu, University of Tsukuba, Japan  
Prof. Isamu Nagano, Komatsu College, Japan  
Assoc. Prof. Dodi Sudiana, Universitas Indonesia, Indonesia  
Assoc. Prof. Chiharu Hongo, Chiba University, Japan  
Assoc. Prof. Handarto, Universitas Padjadjaran, Indonesia  
Assoc. Prof. Emma Hisbaron, Universitas Gadjah Mada, Indonesia  
Assoc. Prof. Muhammad Isman Jusuf, Universitas Muhammadiyah Gorontalo, Indonesia

**Technical Program Committee**

Prof. Agus Hartoko, Universitas Diponegoro, Indonesia  
Prof. Rika Haryana, Universitas Gadjah Mada, Indonesia  
Prof. Andriyan Bayu Suksmono, Institut Teknologi Bandung, Indonesia  
Prof. Wolfgang Martin Boerner, University of Illinois, United States  
Prof. Keiichiro Kondo, Chiba University, Japan  
Prof. Nobuo Takeuchi, Chiba University, Japan  
Prof. Motoi Machida, Chiba University, Japan  
Prof. Hideki Nakagome, Chiba University, Japan  
Prof. Wuled Lenggoro, Tokyo Agricultural University, Japan  
Prof. Bondan T. Sofyan, Universitas Indonesia, Indonesia  
Prof. Sugeng, Universitas Islam Riau, Indonesia  
Prof. Mukhtar Ahmad, Universitas Islam Riau, Indonesia  
Prof. I Wayan Sandi Adnyana, Universitas Udayana, Indonesia  
Prof. Purnomo Priambodo, Universitas Indonesia, Indonesia  
Assoc. Prof. Kazuhiko Ohnuma, Chiba University, Japan  
Assoc. Prof. Rie Ono, Chiba University, Japan  
Assoc. Prof. Basari, Universitas Indonesia, Japan  
Assoc. Prof. Hitoshi Irie, Chiba University, Japan  
Assoc. Prof. Agfianto Putra, Universitas Gadjah Mada, Indonesia  
Assoc. Prof. Yoshimasa Amano, Chiba University, Japan  
Assoc. Prof. Kazuteru Namba, Chiba University, Japan  
Assoc. Prof. Idris Mandang, Universitas Mulawarman, Indonesia  
Assoc. Prof. Tri Kuntoro Priyambodo, Universitas Gadjah Mada, Indonesia  
Assoc. Prof. Gede Karang, Universitas Udayana, Indonesia  
Assoc. Prof. Masuda Kenji, Shizuoka University, Japan  
Assoc. Prof. Katoh Kentaroh, Tsuruoka College, Japan  
Assoc. Prof. Teti Zubaidah, Universitas Mataram, Indonesia  
Assoc. Prof. Rahmatulloh, Universitas Indonesia, Indonesia  
Assoc. Prof. Dr. Nurman, S.Si, M.Si, Universitas Islam Riau, Indonesia  
Dr. Yohandri, Universitas Negeri Padang, Indonesia  
Dr. Elyas Palantei, Universitas Hasanuddin, Indonesia  
Dr. Ilham Alimuddin, Universitas Hasanuddin, Indonesia  
Dr. Luhur Bayuaji, Universiti Malaysia Pahang, Malaysia  
Dr. Muhammad Fauzan, Universitas Brawijaya, Indonesia  
Dr. Yuhendra, Institut Teknologi Padang, Indonesia  
Dr. Indra Riyanto, Universitas Budiluhur, Indonesia  
Dr. Wahyudi Parnadi, Institut Teknologi Bandung, Indonesia  
Dr. Robertus Heru, Lembaga Antariksa dan Penerbangan Nasional, Indonesia



**The 7th Indonesia Japan  
Joint Scientific Symposium  
(IJSS 2016)  
Chiba, 20-24 November 2016**

---

Dr. Evizal Abdul Kadir, Universitas Islam Riau, Indonesia  
Dr. Muhamad Komarudin, Universitas Lampung, Indonesia

**Local Steering Committee  
Secretariat and Registration:**

**Treasurer:**

Chihaya Miyamoto

**Publication:**

Husnul Kausarian  
Asif Awaluddin  
Dr. Ratih Fitria  
Putri Agus Hendra  
Pakhrur Razi

**Reviewers:**

Prof. Kenichi Sakakibara  
Prof. Rie Ono  
Prof. Shogo Shimazu  
Prof. Hitoshi Asanuma  
Prof Josaphat Tetuko Sri Sumantyo  
Prof. Ryutaro Tateishi  
Prof. Katsumi Hattori  
Prof. Eko Tjipto Rahardjo  
Prof. Danang Sri Hadmoko  
Prof. Arif Marfai  
Prof. Muhammad Asvial  
Prof. Ketut Wikantika  
Prof. I Made Mahendra  
Prof. Agus Hartoko  
Prof Hartono  
Prof. Andriyan Bayu Suksmono  
Prof. Motoi Machida  
Prof. Kazuhiko Ohnuma  
Prof. Kazuteru Namba  
Prof. Idris Mandang  
Prof. Gede Karang  
Dr. Dodi Sudiana  
Dr. Yohandri  
Dr. Elyas Palantei  
Dr. Ilham Alimuddin  
Dr. Wahyudi Parnadi  
Dr Mya Dwi Rostika  
Dr Emmy Latifah

**Website Coordinator:**

Babag Purbantoro  
Good Fried Panggabean  
Farohaji Kurniawan

**Documentation:**

Heein Yang



**The 7th Indonesia Japan  
Joint Scientific Symposium  
(IJSS 2016)  
Chiba, 20-24 November 2016**

---

Cahaya Edi Santosa  
Jamrud Aminuddin

**Registration**

Yuta Izumi  
Tomoro Watanabe

## Contents and Schedule

**The 7<sup>th</sup> Indonesia–Japan Joint Scientific Symposium  
The 24<sup>th</sup> CERE<sup>S</sup> International Symposium  
The 4<sup>th</sup> Symposium on Microsatellites for Remote Sensing  
The Symposium on Innovative Microwave Remote Sensing**

November 21-24, 2016  
Keyaki Convention Hall, Chiba University

<b>Monday, November 21</b>	
09:30-12:00	Opening Ceremony (Moderator : Dr Takenobu Aoki and Meidesta Pitria) Opening Remark : General Chairman Prof Hiroaki Kuze Opening Speech : Rector of Chiba University – Prof Takeshi Tokuhisa Opening Speech : Vice President of University of Indonesia – Prof Bambang Wibawarta Inauguration Ceremony of New Sister University : Universitas Islam Riau (UIR) – Chiba University Inauguration Ceremony of International Collaboration : Regency of Siak – Center for Environmental Remote Sensing <b>Keynote Speech (1)</b> – Prof Yoshifumi Yasuoka <b>Keynote Speech (2)</b> – Prof Eko Tjipto Rahardjo <b>Keynote Speech (3)</b> – Drs. H. Syamsuar, M.Si
11:45-12:00	Symposium Memorial Photograph
12:00-13:30	Lunch
13:30-17:00	Laboratory / Research center visiting Prof Hiroaki Kuze – Lidar Facility Prof Josaphat Tetuko Sri Sumantyo – Microwave Remote Sensing Facility Prof Hitoshi Irie – Atmospheric Research Facility Prof Atsushi Higuchi – Himawari-8 Facility (Dr Koichi Toyoshima) Prof Naoko Saito – GOSAT Facility Prof Katsumi Hattori – Geohazard Research Prof Shogo Shimazu – Chemistry Research Facility Prof Hiroshi Asanuma – Mechanical Engineering Prof Motoi Machida – Chemistry Research Facility (22 November 2016 08:00 to 15:30)
13:30-15:00	Alumni Meeting – 3F Reception Hall (Prof Ryoko Niikura) Opening speech – Rector of Chiba University : Prof Takeshi Tokuhisa

<b>Monday, November 21</b>	
15:00-17:00	Business Forum - Keyaki Kaikan Hall (Prof. Kenichi Sakakibara) <ul style="list-style-type: none"> <li>- Bank Riau Kepri</li> <li>- Kabupaten Siak</li> <li>- Kantodensi</li> <li>- APPJ</li> <li>- Dental Support (Prof. Takeshi UCHIDA, R.Ph., Ph.D)  <i>"The Challenge of Medical and Care Supporting System  Japanese Hyper Aging Society"</i> – BF001 <span style="float: right;"><i>in</i></span></li> </ul>
17:00-19:00	Welcome party – 3F Reception Hall Opening speech : <ul style="list-style-type: none"> <li>- Rector of Chiba University : Prof Takeshi Tokuhisa</li> <li>- General Chairman : Prof Hiroaki Kuze</li> <li>- Kanpai (Opening toast) : Prof Ryutaro Tateishi</li> </ul> Japanese traditional dance : <ul style="list-style-type: none"> <li>- Fuuryuu Funazoroi – Fujima Kanhiroyuki</li> </ul> Indonesian traditional dance : <ul style="list-style-type: none"> <li>- Gunung Sari – Siina Takanobu</li> </ul> Introduction of delegations
<b>Tuesday, November 22</b>	
09:30-16:00	Parallel Oral Presentation Session
16:00-17:00	Poster session
17:00-19:00	Banquet – 3F Reception Hall Opening speech : Prof Motoi Machida <ul style="list-style-type: none"> <li>- Kanpai (Opening toast) : Prof Kenichi Sakakibara</li> </ul> Free talk for future exchange and collaboration <ul style="list-style-type: none"> <li>- Prof Katsumi Hattori</li> <li>- Prof Kenichi Sakakibara</li> <li>- Prof Hiroshi Asanuma</li> </ul>
<b>Wednesday, November 23</b>	
09:30-15:00	Parallel Oral Presentation Session
15:30	Closing and Awards Ceremony <ul style="list-style-type: none"> <li>- Best Paper Awards</li> <li>- Best Presenter Awards</li> <li>- Best Poster Awards</li> <li>- Best Student Awards</li> </ul>



## Keynote Speech

Monday, November 21

10:15-11:45

10:15-11:45

Mon, Nov 21

7th Indonesia Japan Joint Scientific Symposium

Chair : Takenobu Aoki

1F Main hall

10:15-10:45

KS001



**Prof Yoshifumi Yasuoka**

Chiba University

*Social Implementation of Remote Sensing; how can remote sensing contribute to tackling climate change*

10:45-11:15

KS002



**Prof Eko Tjipto Rahardjo**

Universitas Indonesia (UI)

*Environmental impact of electromagnetic fields and waves*

11:15-11:45

KS003



**Drs. H. Syamsuar, M.Si**

Mayor/Regent of Regency of Siak, Riau Province, Indonesia

*The success steps of Regency of Siak in tackling environmental issues; resolving the problem of forest fires in Siak District, Riau Province; Achievement of the National Environment Award 2015 and 2016*

## Oral Session

Tuesday, November 22

09:30-16:00

09:30-11:50 Tue, Nov 22	7th Indonesia Japan Joint Scientific Symposium #1	Chair : Elyas Palantei 3F Reception Hall
<b>09:30 - 09:50</b> <b>P113</b>	<b>Elyas Palantei (p: 1- 9)</b> <i>Construction and Field Testing of Broadband Transceiver Modules Applied for ITS Environmental Surveillance</i>	
<b>09:50 - 10:10</b> <b>P156</b>	<b>Purnomo Sidi Priambodo (p: 10- 15)</b> <i>FSO Propagation Noise Suppression by Applying Single-Mode Fiber Optic at The Receiving Lens Focal Point</i>	
<b>10:10 - 10:30</b> <b>P118</b>	<b>Ahmad Fauzi Makarim (p: 16-24)</b> <i>Design and Analysis of Mesh Network for Ship-to-Ship Maritime Communication using IEEE 802.11 on Maritime Environment of Tanjung Perak – Indonesia</i>	
<b>10:30 - 10:50</b> <b>P001</b>	<b>Abdul Syukur (p: 25- 36)</b> <i>Parallel Processing for Improve Performance of e-Learning Server Using Message Passing Interface</i>	
<b>10:50 - 11:10</b> <b>P159</b>	<b>Wahidin Wahab (p: 37- 42)</b> <i>Designing an Automated control of a Portable Hydrophonic Plantation Facility based on</i>	
<b>11:10 - 11:30</b> <b>P092</b>	<b>Imaduddin A Majid</b> <i>Path Planning and Formation Control using Arrival Time Field for Mobile Robots</i>	
<b>11:30 - 11:50</b> <b>P154</b>	<b>Basari (p: 43- 48)</b> <i>On the Performance of Wireless ECG Monitoring System: Case of Off-Body Communications</i>	
09:30-12:00 Tue, Nov 22	The 4th Symposium on Microsatellites for Remote Sensing	Chair : Katsumi Hattori 3F Meeting Room 4
<b>09:30 - 10:00</b> <b>P146</b>	<b>Katsumi Hattori</b> <i>Seismo-electromagnetics study for short-term earthquake forecast: recent progress and the state of the art</i>	
<b>10:00 - 10:30</b> <b>P150</b>	<b>Dimitar Ouzounov</b> <i>Geospace Approach in Revealing Transient Signatures in Atmosphere and Ionosphere Prior to Large Earthquakes</i>	
<b>10:30 - 11:00</b> <b>P148</b>	<b>Nicola Genzano</b> <i>On the possible impact of the Significant Sequence of TIR Anomalies (SSTAs) parameter on the time-Dependent Assessment of the Seismic Hazard (t-DASH) for Japan</i>	
<b>11:00 - 11:30</b> <b>P127</b>	<b>Teti Zubaidah (p:1-9)</b> <i>Observation of geomagnetic fields changes related to 9th March 2016 solar eclipse on Lombok Island-Indonesia</i>	

09:30-11:50 Tue, Nov 22	7th Indonesia Japan Joint Scientific Symposium #2	Chair : Agus Hartoko 2F Meeting Room 2
09:30 - 09:50 P004	<b>Agus Hartoko (p: 49- 58)</b> <i>New Paradigm of Marine Paleo-oceanographic Study With Spatial Based Reconstruction at Sangiran and Muria Strait – Central Java Indonesia</i>	
09:50 - 10:10 P074	<b>Tengku Dahril (p: 59- 63)</b> <i>Applied technology for oxygen production in closed area for smoke damage</i>	
10:10 - 10:30 P075	<b>Tengku Dahril (p: 64- 70)</b> <i>The utilization of liquid water from palm oil industry as culture medium for microalgae (Chlorella sp) in order to eliminate waters pollution in Riau</i>	
10:30 - 10:50 P089	<b>Idris Mandang (p: 71- 78)</b> <i>Ecosystem Dynamics in the Mahakam Estuary, East Kalimantan Indonesia</i>	
10:50 - 11:10 P086	<b>I Wayan Gede Astawa Karang (p: 79-88)</b> <i>Aquarius Sea Surface Salinity in the Indonesian Seas</i>	
11:10 - 11:30 P029	<b>Muh. Yusuf (p: 89- 95)</b> Coastal Dynamic, Nitrate (NO <sub>3</sub> -) Phosphate (PO <sub>4</sub> -) and Phytoplankton Abundance at Morodemak North Java Sea Indonesia	
11:30 - 11:50 P013	<b>Jemi (p: 96-102)</b> Water Resources Management Using River Flow Manipulation in Sukabumi Karst Landform	
09:30-11:50 Tue, Nov 22	7th Indonesia Japan Joint Scientific Symposium #3	Chair : Ardi Pramono 2F Meeting Room 3
09:30 - 09:50 P157	<b>Ardi Pramono (p: 103- 107)</b> <i>The Use Of Continuous Intravenous Multimodal Analgesia Fentanyl-Ketorolac In Patients With Cesarean Section</i>	
09:50 - 10:10 P142	<b>Tri Pitara Mahanggoro (p: 108-113)</b> <i>Improving Emotional Intelligence to Develop Healthy Behaviour in Leather Gloves Factory Worker</i>	
10:10 - 10:30 P153	<b>Ratna Indriawati (p: 114-118)</b> <i>Long-term Impact of Prenatal hypoxia-ischemia in short-term memory during adolescence</i>	
10:30 - 10:50 P054	<b>Dziban Naufal (p: 119-125)</b> <i>Effects of Low Frequency Sound to Human Psychological and Physiological Phenomenon : A literature review</i>	
10:50 - 11:10 P046	<b>Pramitha Esha ND (p: 126-131)</b> <i>Identification of Patient Satisfactory Profile for Outpatient Pharmaceutical Service at Private and Government Hospital within Semarang District</i>	
11:10 - 11:30 P018	<b>Rudy Agung Nugroho (p: 132-139)</b> Insect-Based Protein: Future Promising Protein Source for Fish Cultured	
11:30 - 11:50 P022	<b>Norman Billi (p: 140-144)</b> A Literature Study : Potential of Mango Seed as an Alternative Feed of Tegal Duck for Increasing Body Weight	

09:30-12:00 Social Studies #1 Chair : F. Kaneko & E. Latifah  
Tue, Nov 22 2F Multimedia meeting room

09:30 - 10:00 P049	<b>Fumihiko Kaneko (p:1-7)</b> <i>Introducing A Threshold To Condorecet Improvement</i>
10:00 - 10:30 P032	<b>Emmy Latifah</b> <i>The Legal Protection Over Traditional Medicinal Plants in Indonesia</i>
10:30 - 11:00 P164	<b>Abdul Qodir (p:8-24)</b> <i>The Idea of Multicultural Interconnective with Socio-Religious Values at Trans Dalam Community in Pulang Pisau Regency</i>
11:00 - 11:30 P120	<b>Achmad Busro (p:25-32)</b> <i>LEGAL DEVELOPMENTS OF FIDUCIARY IN INDONESIA: A Special Reference to Intangible Moving Security Objects</i>
11:30 - 12:00 P053	<b>Yosuke Yoshioka (p:33-37)</b> <i>The Effect of Communication Skills on Job Opportunities for Japanese University Students</i>

09:30-12:00 Social Studies #2 Chair : Indah Susilowati  
Tue, Nov 22 2F Graduate Lounge

09:30 - 10:00 P108	<b>Rachma Indriyani (p:38-45)</b> <i>Where Does Equitable Sharing Of Shared Fish Stocks In Indian Ocean Stand For ?</i>
10:00 - 10:30 P109	<b>Slamet RIYADI</b> <i>Study Of User Experience In A Sequential Interaction Of A Tangible Product</i>
10:30 - 11:00 P161	<b>Satsuki Ikeda (p: 46-52)</b> <i>Our use of descriptive names and singular thoughts</i>
11:00 - 11:30 P039	<b>Yayoi Umemura (p:279-286)</b> <i>Miscommunication in Japanese between Japanese and Local Employees in a Japanese-affiliated Company in China</i>
11:30 - 12:00 P122	<b>Hadi Sasana</b> <i>Cluster Area Development with the Basis on Organic Agriculture To Support The Competitiveness on Acceleration to Enter the Asean Economic Community Market (Case Study in Semarang- Indonesia)</i>

13:00-14:20 7th Indonesia Japan Joint Scientific Symposium #4 Chair : M Isman Jusuf  
Tue, Nov 22 3F Reception Hall

13:00 - 13:20 P067	<b>M Isman Jusuf</b> <i>Prediction of Intracerebral Haemorrhagic Stroke In Indonesian Population</i>
13:20 - 13:40 P061	<b>Pinasti Utami (p: 145-153)</b> <i>Identification of Drug Related Problems in Congestive Heart Failure Patients in Panembahan Senopati Public Hospital During January to May 2015</i>
13:40 - 14:00 P071	<b>Nurul Maziyyah (p: 154-162)</b> <i>Actual and Potential Drug Related Problems in Diabetic Patients through Medication Reconciliation Process</i>
14:00 - 14:20 P081	<b>Ingenida Hadning (p: 163-169)</b> <i>Analysis Influence of Early Pharmaceutical Exposure in Primary Health Care on Student's Knowledge Levels in School of Pharmacy Universitas Muhammadiyah Yogyakarta</i>

14:35-15:55 Tue, Nov 22	7th Indonesia Japan Joint Scientific Symposium #5	Chair : Lilis Suryani 3F Reception Hall
<b>14:35 -14:55</b> <b>P139</b>	<b>Lilis Suryani (p: 170-174)</b> <i>The Effect of Supplementation Probiotic Lactobacillus casei strain Shirota against colonization of Streptococcus Nasal Swab Isolates from Patients with Allergic Rhinitis</i>	
<b>14:55 - 15:15</b> <b>P140</b>	<b>Sri Nabawiyati Nurul Makiyah (p: 175-184)</b> <i>Steroidal Saponin in Ethanol Extract Tuber of Purple Yam (Dioscorea alata L.) as allergenic Agent</i>	
<b>15:15 - 15:35</b> <b>P143</b>	<b>Tri Wulandari Kesetyaningsih (p: 185-193)</b> <i>Dengue Prone Areas in Gamping, Yogyakarta, Indonesia Based on Environmental Condition by Using Spatial Analysis</i>	
<b>15:35 - 15:55</b> <b>P141</b>	<b>Yuningtyaswari (p: 194-199)</b> <i>The Effect of Air Freshener Exposure at an Early Age on Alveolar Histology of White Rat (Rattus norvegicus)</i>	
13:00-14:20 Tue, Nov 22	7th Indonesia Japan Joint Scientific Symposium #6	Chair : Wahidin Wahab 3F Meeting Room 4
<b>13:00 - 13:20</b> <b>P160</b>	<b>Wahidin Wahab (p: 200-207)</b> <i>Analysis and Design of a Fuzzy Logic Controlled Buck Boost Converter For a Wind Turbine Power Generation</i>	
<b>13:20 - 13:40</b> <b>P135</b>	<b>Nji Raden Poespawati (p: 208-213)</b> <i>Fabrication of CNT microarray for biosensor applications</i>	
<b>13:40 - 14:00</b> <b>P011</b>	<b>Indra Riyanto (p: 214-219)</b> <i>Portable Photovoltaic Powerplant with Solar Tracker for Disaster Affected Area Emergency Power Supply</i>	
<b>14:00 - 14:20</b> <b>P014</b>	<b>Mohammad Nasucha (p: 220-229)</b> <i>Application of 6A05G Power Diodes in a Simple Yet Effective Voltage Adapter Module for Electric Cars</i>	
<b>14:20 -14:40</b> <b>P097</b>	<b>Wisnu</b> <i>Obstacle avoidance multirotor using ultrasonic sensor and A-star Algorithm</i>	
14:55-15:55 Tue, Nov 22	7th Indonesia Japan Joint Scientific Symposium #7	Chair : Puguh Novi Arsito 3F Meeting Room 4
<b>14:55 - 15:15</b> <b>P082</b>	<b>Puguh Novi Arsito (p: 230-240)</b> <i>Piperin of Piper retrofractum Antagonizes H1 Receptor: In vitro and In silico Study on Isolated-Guinea Pig Ileum Smooth Muscle</i>	
<b>15:15 - 15:35</b> <b>P138</b>	<b>Alfaina Wahyuni (p: 241-247)</b> <i>The Effect Of Extract Yellow Pumpkins Seed (Cucurbita moschata) on Histology of Endometrial Glands in Ovariectomized Rats</i>	
<b>15:35 - 15:55</b> <b>P144</b>	<b>Imaniar Ranti (p: 248-254)</b> <i>Haloperidol Combination Therapy More Cost- Effective Than Risperidone Combination Therapy in The Acute Phase Therapy of Schizophrenia based on Positive and Negative Syndrome Scale – Component (PANSS-EC)</i>	

13:00-14:20 Tue, Nov 22	7th Indonesia Japan Joint Scientific Symposium #8	Chair : Sabtanti Harimurti 2F Meeting Room 2
<b>13:00 - 13:20</b> <b>P080</b>	<b>Sabtanti Harimurti (p: 255-262)</b> <i>Optimization of the Acid Catalyst Concentration for Synthesis of Anti-Cancer Agent Gamavuton-0 by Using Mathematical and Statistical Software</i>	
<b>13:20 - 13:40</b> <b>P052</b>	<b>MT Ghozali (p: 263-269)</b> <i>Effervescent Tablet Formulation of Purple Mangosteen (<i>Garcinia mangostana</i> L) and Apple (<i>Pyrus malus</i> L) Peel Extract</i>	
<b>13:40 - 14:00</b> <b>P035</b>	<b>Wira Eka Putra</b> <i>Single Dose Dexamethasone Promotes Expression Number of Hematopoietic Stem Cells and Blood Progenitor Cells on BALB/c Mouse</i>	
<b>14:00 - 14:20</b> <b>P080</b>	<b>Hari Widada (p: 270-279)</b> <i>Antioxidant and Photoprotective Potential of Ethyl Acetate Fraction from Ethanolic Extract of Red Dragon Fruit Peel (<i>Hylocerius polyrhizus</i>)</i>	
14:35-15:35 Tue, Nov 22	7th Indonesia Japan Joint Scientific Symposium #9	Chair : Yoni Astuti 2F Meeting Room 2
<b>14:35 - 14:55</b> <b>P047</b>	<b>Yoni Astuti (p: 280-285)</b> <i>Effectiveness of Wound Cleansing Using Guava Leaves 20% Infusion with Showering Technique 15 Psi Pressure toward the number of bacteria on Diabetic Foot Ulcer at Kitamura Clinic, Pontianak</i>	
<b>14:55 - 15:15</b> <b>P145</b>	<b>Ika Setyawati (p: 286-290)</b> <i>Relation Between Uric Acid Level and Risk Factor in Patient with Hypertension</i>	
<b>15:15 - 15:35</b> <b>P088</b>	<b>Sri Tasminatun (p: 291-296)</b> <i>The Effect of Ethanolic Extract of seeds of pumpkin (<i>Cucurbita moschata</i>) on Bone Calcium Levels in Ovariectomized Rat</i>	
13:00-14:20 Tue, Nov 22	7th Indonesia Japan Joint Scientific Symposium #10	Chair : Ismail Alif Siregar 2F Meeting Room 3
<b>13:00 - 13:20</b> <b>P070</b>	<b>Ismail Alif Siregar (p: 297-306)</b> <i>Redesign of Small Vehicles into a safer Public Transit Transport Supporting Major Transport Lines</i>	
<b>13:20 - 13:40</b> <b>P094</b>	<b>Nisrina Muthi Meidiani (p: 307-313)</b> <i>Enliven Urban Life Through Third Places With Home-like Experience</i>	
<b>13:40 - 14:00</b> <b>P012</b>	<b>Ipank Sidiq P (p: 314-318)</b> <i>Location-based Service for Jakarta's Bajaj Auto Rickshaw Ordering System</i>	
<b>14:00 - 14:20</b> <b>P008</b>	<b>Fadilla Indrayuni Prastyasari</b> <i>The Application of Failure Modes and Effects Analysis to The Fuel Oil System on A Tugboat</i>	

14:35-15:35 Tue, Nov 22	7th Indonesia Japan Joint Scientific Symposium #11	Chair : M. Hamzah Solim 2F Meeting Room 3
<b>14:35 -14:55</b> <b>P011</b>	<b>M. Hamzah Solim (p: 319-328)</b> <i>Enhance Production of Adventitious Root Biomass of <i>Talinum paniculatum</i> Gaertn. in Baloon Type Bubble Bioreactor Used by Batch and Continuous System</i>	
<b>14:55 - 15:15</b> <b>P005</b>	<b>Arif Efendi</b> <i>The Effect of Solvent In Green Synthesis Silver Nanoparticles Using Extract Of Gambir (<i>Uncaria gambir</i> Roxb) Leaf</i>	
<b>15:15 - 15:35</b> <b>P017</b>	<b>Muhammad Evan N (p: 329-334)</b> <i>Leaf Callus Induction of Kelor (<i>Moringa oleifera</i>) with Addition of Various Concentration Naphthalene Acetic Acid (NAA) and Kinetin in Media MS in vitro</i>	
<b>15:35 - 15:55</b> <b>P105</b>	<b>Arif Munandar/Randi Proska Sandra (p: 335-343)</b> <i>The Utilization of CaO Nanoparticle From Limestone as A Countermeasure Effort of SO<sub>2</sub> Gas Emissions In PT. Semen Padang Using Corprecipitation Method</i>	
13:00-16:00 Tue, Nov 22	Social Studies #3	Chair : Shingo Odani 2F Multimedia meeting room
<b>13:00 - 13:30</b> <b>P125</b>	<b>Shingo Odani (p:53-60)</b> <i>Ecological Anthropological Analysis of Nyale Foraging and the Sasak Calendar System in Lombok</i>	
<b>13:30 - 14:00</b> <b>P068</b>	<b>Nazalia Kurnia Dewi (p:61-66)</b> <i>A Preliminary Study on the Experience of Indonesian Certified Kaigofukushishi/Candidate Who Work at Japanese Nursing Home in Japan: A Result from Participant Observatory</i>	
<b>14:00 - 14:30</b> <b>P098</b>	<b>Ali Sadikin (p:67-85)</b> <i>The Response Of Public In Palangka Raya To Bank Muamalat Indonesia (BMI) Palangka Raya Branch</i>	
<b>14:30 - 15:00</b> <b>P121</b>	<b>Deli Nirmala</b> <i>Maintaining Javanese Sociocultural Expressions for Preserving the Identity Representation of the Coastal Society in the North of Java (Pantura), Indonesia</i>	
<b>15:00 - 15:30</b> <b>P095</b>	<b>Uha Julaeha (p:86-93)</b> <i>Fairy Tale Roles In Family Communication As Effort Encouraging Early Childhood Development: Literature Study</i>	
<b>15:30 - 16:00</b> <b>P098</b>	<b>Ahmad Dakhoir (p:94-107)</b> <i>Economic Thought Of Ibn Taimiyah On Market Mechanism In Perspective Of Moslem Scholars</i>	

13:00-16:00 Tue, Nov 22	Social Studies #4	Chair : YOSHIDA Masami 2F Graduate Lounge
<b>13:00 - 13:30</b> P158	<b>YOSHIDA Masami (p:108-117)</b> <i>Deployment of Digital Textbooks in Japan</i>	
<b>13:30 - 14:00</b> P009	<b>Fatmawati Djafri (p:118-127)</b> <i>An Inquiry into the Meaning-Making Process of Japanese Learning in Higher Educational Institution in Indonesia</i>	
<b>14:00 - 14:30</b> P165	<b>M. Zainal Arifin (p:287-304)</b> <i>Comparative Study On The Learning Styles (Visual, Auditory, And Kinesthetic) Towards Vocabulary Mastery</i>	
<b>14:30 - 15:00</b> P087	<b>Toshio Irie (p:305-310)</b> <i>Hidden Aspects of the Private Language Argument: What Will Wittgenstein's Philosophy Bring Us Henceforth?</i>	
<b>15:00 - 15:30</b> P034	<b>Hakim and Arin Fithriana (p:128-136)</b> <i>The Support Of Public Works &amp; Community Housing Development Ministry On Poverty Eradication Through Special Fisherman Home</i>	
<b>15:30 - 16:00</b> P025	<b>Otsuka Moe (p:137-142)</b> <i>The Translation of Japanese Manga in German and English</i>	



## Oral Session

Wednesday, November 23

09:30-15:00

09:30-12:00 Wed, Nov 23	Novel Disaster Mitigation Engineering Toward Future	Chair : Hiroshi Asanuma 3F Reception Hall
<b>09:30 - 10:00</b> P132	<b>Hiroshi Asanuma (p:1-9)</b> <i>Smart disaster mitigation based on novel structures/materials</i>	
<b>10:00 - 10:30</b> P055	<b>Nanang T. Puspito (p:10-16)</b> <i>Seismological Evidence for Crustal Deformation beneath the Sunda-Banda Arc Transition Zone</i>	
<b>10:30 - 11:00</b> P126	<b>Djati Mardiatno (p:17-25)</b> <i>Identification of Area Prone to Multi Hazards using Remotely Sensed Data - Case in Lowland Area of Kulon Progo, Yogyakarta, Indonesia</i>	
<b>11:00 - 11:30</b> P107	<b>Toha Saleh (p:26-36)</b> <i>Analysis of Stream and Residential Area Protection Case Study: Tembagapura, Papua</i>	
<b>11:30 - 12:00</b> P057	<b>Dyah Rahmawati Hizbaron (p:37-45)</b> <i>Vulnerability of Volcanic Ternate Island Towards Ecosystem Based Disaster Risk Management</i>	
09:30-11:50 Wed, Nov 23	The 24th CEReS International Symposium	Chair : Nobuo TAKEUCHI 3F Meeting Room 4
<b>09:30 - 09:50</b> P093	<b>Nobuo TAKEUCHI (p:1-10)</b> <i>Investigation of a High Resolution Lidar Using Optical Frequency Comb</i>	
<b>09:50 - 10:10</b> P163	<b>Nofel Lagrosas (p:11-14)</b> <i>Modeling of scattering enhancement factor, <math>f(RH)</math>, in Chiba using visibility and ground measurements</i>	
<b>10:10 - 10:30</b> P069	<b>D. Ichikawa</b> <i>Geostationary HIMAWARI-8 and Polar Orbiting S-NPP VIIRS Satellites for regional environmental monitoring of Indonesia</i>	
<b>10:30 - 10:50</b> P041	<b>Jamrud Aminuddin (p:15-18)</b> <i>Observation of Aerosol Optical Properties by Means of Himawari-8 Satellite from Space and Lidar System from Surface</i>	
<b>10:50 - 11:10</b> P110	<b>Babag Purbantoro (p:19-22)</b> <i>Cloud Retrieval and Cloud Type Detection from Himawari-8 Satellite Data Based on the Split Window Algorithm</i>	
<b>11:10 - 11:30</b> P119	<b>Ginaldi Ari N / Asif Awaludin (p:33-39)</b> <i>Hail Detection By A Low Cost Local Weather Radar Operated For Disaster Early Warning System</i>	
<b>11:30 - 11:50</b> P042	<b>Andung Bayu Sekaranom (p:23-32)</b> <i>Extreme precipitation over Indonesian maritime continent: Uncertainties in satellite estimation and its relationship with low storm top height extreme</i>	

09:30-11:50 Wed, Nov 23	The Symposium on Innovative Microwave Remote Sensing	Chair : Josaphat Tetuko SS 2F Meeting Room 2
<b>09:30 - 10:00</b> <b>P062</b>	<b>Josaphat Tetuko SS (p:1-7)</b> <i>Development of Synthetic Aperture Radar onboard Aircraft and Microsatellite for Global Land Deformation Observation</i>	
<b>10:00 - 10:30</b> <b>P168</b>	<b>CHUA Ming Yam (p:8-17)</b> <i>Phase Coded Stepped Frequency Linear Frequency Modulated Waveform Synthesis Technique for Ultra-Wideband Synthetic Aperture Radar</i>	
<b>10:30 - 11:00</b> <b>P167</b>	<b>Achmad Munir</b> <i>DDS Module-based Frequency-Modulated Continuous-Wave (FMCW) Signal Generation</i>	
<b>11:00 - 11:30</b> <b>P130</b>	<b>Agus Hendra Wahyudi (p:18-26)</b> <i>NETWORK BASED DATA ACQUISITION AND CONTROL SYSTEM FOR CIRCULAR POLARISATION SAR (CP-SAR) SENSOR ON UAV</i>	
<b>11:30 - 12:00</b> <b>P149</b>	<b>Masaru Bunya (p:27-33)</b> <i>CP-SAR Image Processing System with Kintex-7 FPGA Board</i>	
09:30-11:50 Wed, Nov 23	7th Indonesia Japan Joint Scientific Symposium #12	Chair : Imam Damar DJATI 2F Meeting Room 3
<b>09:30 - 09:50</b> <b>P096</b>	<b>Imam Damar DJATI (p: 344-352)</b> <i>Young Teak Application For Making Products Case Study: Young Teak from the Teak Plantation in West Java Area, Indonesia</i>	
<b>09:50 - 10:10</b> <b>P037</b>	<b>Hari Nugraha (p: 353-361)</b> <i>Hybrid Bamboo – Ceramic Process for Tableware design</i>	
<b>10:10 - 10:30</b> <b>P016</b>	<b>M Dzulfiqar Rizwanda Putra (p:362-367)</b> <i>“Bagasse Bamboo Concrete” Waste Utilization of Cane and Bamboo Fiber For Composing Material Natural Fibrous Concrete</i>	
<b>10:30 - 10:50</b> <b>P059</b>	<b>Ilham Kurniawan</b> <i>The Influence of the addition Sugar Cane Bagasse Ash in compressive strength of Geopolymer Concrete</i>	
<b>10:50 - 11:10</b> <b>P076</b>	<b>Anne Zulfia (p:368-377)</b> <i>Effect of Titanium Addition on Characteristic of Al6061/ Al2O3 Reinforced Composites Produced by Stir Casting Process</i>	
<b>11:10 - 11:30</b> <b>P066</b>	<b>Adi Novriansyah/Novrianti</b> <i>Enhancing cement strength through nanocomposite additive: utilizing palm-shell-waste in oil-well cementing job</i>	

09:30-12:00 Wed, Nov 23	Social Studies #5	Chair : Chiyo Yonemura 2F Multimedia meeting room
<b>09:30 - 10:00</b> P058	<b>Chiyo Yonemura (p:143-149)</b> <i>The Development of Organic Farming and Family Change in Postwar Japan</i>	
<b>10:00 - 10:30</b> P112	<b>Akiko Fuchu (p:150-154)</b> <i>How parents' thinking and behavior work for their unmarried daughters</i>	
<b>10:30 - 11:00</b> P047	<b>Pradhikna Yunik Nurhayati (p:155-164)</b> <i>Japanese soy sauce industry: a legacy of the centuries</i>	
<b>11:00 - 11:30</b> P123	<b>Tri Widayati</b> <i>The Ways Forward to Ecosystem-based Farming Management in Dieng Mountain, Central Java-Indonesia: A Proposed Model</i>	
<b>11:30 - 12:00</b> P015	<b>M Agung Ady Mangilep (p:270-278)</b> <i>The Importance of Paddy Rice Production for the Agricultural Communities in the Highland of South Sulawesi</i>	
09:30-12:00 Wed, Nov 23	Social Studies #6	Chair : Shuhei Shiozawa 2F Graduate Lounge
<b>09:30 - 10:00</b> P010	<b>Fitriwati (p:165-170)</b> <i>Introducing of Research and Development and Manufacturing Polyhydroxyalkanoates From Palm Oil Industry to Local Community in South Sulawesi</i>	
<b>10:00 - 10:30</b> P030	<b>Ramadhan Febriansyah (p:171-177)</b> <i>INTEGRATION OF SLC (SOCIETY LIVESTOCK CENTER) WITH PENTAHHELIX SYSTEM AS AN INDONESIAN STRATEGY IN LIVESTOCK DEVELOPMENT AND FARMERS EMPOWERMENT TOWARD AEC (ASEAN ECONOMIC COMMUNITY)</i>	
<b>10:30 - 11:00</b> P124	<b>Agus Indarjo</b> <i>An Introducing the Tripartite Model of University-Government-Communities in Managing Karimunjawa and Its National Park: Safe for Future Sustainable Development</i>	
<b>11:00 - 11:30</b> P064	<b>Junko NANAHOshi (p:178-185)</b> <i>A Consideration of Expectations in Nursing Education Regarding Relationships with Patients — Main Focus on Textbook Analysis of High School Nursing Departments —</i>	
<b>11:30 - 12:00</b> P036	<b>Shuhei Shiozawa (p:186-194)</b> <i>A Game Theory Approach to the Bargaining Process between Japan and the U.S. in the Pre-War Period</i>	

13:00-14:00 Wed, Nov 23	7th Indonesia Japan Joint Scientific Symposium #13	Chair : Eko T Rahardjo 3F Reception Hall
<b>13:00 - 13:20</b> <b>P155</b>	<b>Eko T Rahardjo (p:511-514)</b> <i>Radiation Performance of X-Band Array Antenna Implemented Using Unequal Power Divider Feeding System</i>	
<b>13:20 - 13:40</b> <b>P116</b>	<b>Fitri Yuli Zulkifli (p:378-383)</b> <i>Differential-Fed Circular Patch Antenna with High Impedance Surface Substrate</i>	
<b>13:40 - 14:00</b> <b>P060</b>	<b>Evizal Abdul Kadir (p:384-391)</b> <i>MIMO Antenna System for Microsatellite Communications</i>	
<b>14:00 - 14:20</b> <b>P056</b>	<b>M Fauzan Edy Purnomo (p:392-403)</b> Development L-Band Antena With Low Power For Circularly Polarized-Synthetic Aperture Radar (Cp-Sar) Application On Unmanned Aerial Vehicle (UAV)	
<b>14:20 - 14:40</b> <b>P043</b>	<b>Cahya Edi Santosa</b> <i>Circularly Polarized Microstrip Antenna with Eye-slot for X-band Synthetic Aperture Radar Application</i>	
13:00-15:00 Wed, Nov 23	7th Indonesia Japan Joint Scientific Symposium #14	Chair : Kenji Kuriyama 3F Meeting Room 4
<b>13:00 - 13:20</b> <b>P090</b>	<b>Kenji Kuriyama (p:404-407)</b> <i>Ground-based Spectral Measurements of Chlorophyll Fluorescence from Vegetation Canopies</i>	
<b>13:20 - 13:40</b> <b>P115</b>	<b>Muhammad Kamal</b> <i>The effect of field spectrometer measurement distance to the identification of Rhizophora stylosa mangrove from remote sensing imagery</i>	
<b>13:40 - 14:00</b> <b>P113</b>	<b>Pramaditya Wicaksono</b> <i>Preliminary assessment of Sentinel-2A Multispectral Image and UAV for mapping and validation of benthic habitats composition</i>	
<b>14:00 - 14:20</b> <b>P026</b>	<b>Derick Christopher AM (p:408-416)</b> The Use of Hyperspectral Data to Analyze Climate Change According to Carbon Stocks and Southeast Sulawesi Biodiversity	
<b>14:20 - 14:40</b> <b>P050</b>	<b>Yuta izumi (p:417-422)</b> <i>Polarimetric analysis of long term paddy rice observation using ground-based SAR (GB-SAR) system</i>	
<b>14:40 - 15:00</b> <b>P078</b>	<b>Akhmad Arifin Hadi (p:423-432)</b> <i>Exploring Attractive Landscape Elements and Sceneries in Bukit Kucing Forest Tanjungpinang by using Visitors-Employed Photography Method</i>	

13:00-15:00 Wed, Nov 23	7th Indonesia Japan Joint Scientific Symposium #15	Chair : Dodi Sudiana 2F Meeting Room 2
<b>13:00 - 13:20</b> P128	<b>Dodi Sudiana (p:433-441)</b> <i>Deformation Analysis of Merapi Volcano Using DInSAR on ALOS/PALSAR Image</i>	
<b>13:20 - 13:40</b> P129	<b>Dodi Sudiana (p:442-451)</b> <i>Analyzing Land Use and Land Cover using Combined Landsat 8 and ALOS-2/PALSAR-2's Data-Case Study: Bandung Regency</i>	
<b>13:40 - 14:00</b> P038	<b>Husnul Kausarian (p:452-458)</b> <i>Geological Mapping for the Land Deformation Using Small UAV, DinSAR Analysis and Field Observation at The Siak Bridge I and II, Pekanbaru City, Indonesia</i>	
<b>14:00 - 14:20</b> P114	<b>Arliandy P. Arbad (p:459-466)</b> <i>Time Series InSAR For Interpretating 5 Years Cycle of Mt. Bromo Eruptions in Indonesia by Using PALSAR and PALSAR-2 to Contribute Civil Engineering Work</i>	
<b>14:20 - 14:40</b> P166	<b>Pakhrur Razi</b> <i>Velocity and Time Series Land Deformation Monitoring in Slope Area using PSI SAR: Case Study in Kelok 9 Bridge West Sumatra</i>	
<b>14:40 -15:00</b> P079	<b>Richa Bhattarai (p467-472)</b> <i>Risk Assessment of Land Subsidence in Kathmandu Valley, Nepal</i>	
13:00-15:00 Wed, Nov 23	7th Indonesia Japan Joint Scientific Symposium #16	Chair : Puji Astuti 2F Meeting Room 3
<b>13:00 - 13:20</b> P003	<b>Agil Gemilang Ramadhan (p473-482)</b> <i>Structure Delineation Mapping using Remote Sensing Techniques in Geothermal Prospect Area Kepahiang, Bengkulu</i>	
<b>13:20 - 13:40</b> P051	<b>Puji Astuti (p483-491)</b> <i>Optimalization of the Planning Area in Using Infrastructure Development Impact of the Petroleum and Palm Oil Industry in Minas District, Riau Province</i>	
<b>13:40 - 14:00</b> P077	<b>Dewandra Bagus EP (p:515-524)</b> <i>Geophysical Modelling Using Gravity Data Of Meteorite Impact Crater At Bukit Bunuh, Lenggong, Perak, Malaysia</i>	
<b>14:00 - 14:20</b> P091	<b>Ira Herawati, Novia Rita (p492-501)</b> <i>Determining Equation of Oil ate Prediction by Statistically Analysis Function in New Productive Zone</i>	
<b>14:20 - 14:40</b> P072	<b>Yuniarti Yuskara (p502-510)</b> <i>Sedimen Deposit of Floodplain Formation Resulting From Lateral Accretion Surfaces On Tropical Area: Study Case At Kampar River, Indonesia</i>	
<b>14:40 -15:00</b> P006	<b>Catur Cahyaningsih</b> <i>Meteorite Impact Crater Mahsuri Ring Profile, Langkawi, Kedah Province, Malaysia, Using Geoelectric Resistivity Imaging</i>	

13:00-15:00 Wed, Nov 23	Social Studies #7	Chair : Noriko Ashiya 2F Multimedia meeting room
<b>13:00 - 13:30</b> <b>P020</b>	<b>Noriko Ashiya (p:195-204)</b> <i>A possible answer to Japan's deflationary problem as revealed by the use of a modified Phillips curve, and an explanation of some seemingly contradictory results</i>	
<b>13:30 - 14:00</b> <b>P033</b>	<b>Tri Endangsih/Jeanie Annissa (p:205-212)</b> <i>Army Support Program Through Smart Home In Poverty Reduction Framework Based on SDGs</i>	
<b>14:00 - 14:30</b> <b>P084</b>	<b>Nunuk Endah Srimulyani (p:213-223)</b> <i>Mom's War and the Misconception about "Ryosai kenbo" and "Kyoiku-Mama": Case of Educated Middle-Class Women in Indonesia</i>	
<b>14:30 - 15:00</b> <b>P063</b>	<b>Zhu Xun (p:224-233)</b> <i>A Comparative Study of Economic Revitalization Policy in Coal Mining Areas Between China and Japan- From the Spatial Perspective</i>	
13:00-15:00 Wed, Nov 23	Social Studies #8	Chair : Kousuke Kaita 2F Graduate Lounge
<b>13:00 - 13:30</b> <b>P073</b>	<b>Xing Yun (p:234-243)</b> <i>Analysis on the Research Trends of CALL in China -Based on the Papers from CNKI from 2010 to 2016</i>	
<b>13:30 - 14:00</b> <b>P065</b>	<b>Kousuke Kaita (p:244-253)</b> <i>Causative and adhortative expressions in Medieval English</i>	
<b>14:00 - 14:30</b> <b>P048</b>	<b>XIANG YANING (p:254-262)</b> <i>A Basic Study of Academic English Vocabulary Lists</i>	
<b>14:30 - 15:00</b> <b>P044</b>	<b>Masakazu Ito (p:263-269)</b> <i>Promoting Cities through Shopping Street Unions in Japan</i>	

## POSTER SESSION

Tuesday, November 22

16:00-17:00

No	Presenter	Title
<b>P152</b>	Tiger Jann-Yenq Liu	A Statistical Study Applying Receiver Operating Characteristic Curve on Seismo-ionospheric Precursors of the Total Electron Content Associated with Large Earthquakes in Japan
<b>P104</b>	Miftahus Sa'adah	Knowledge sharing practices: a case study of the center of language development at the state Islamic university Sunan Kalijaga Yogyakarta
<b>P103</b>	Siti Nur Hidayah	Entrepreneurship Education and its Challenges in Non-business Faculties of Islamic Higher Education
<b>P102</b>	Roma Ulinuha	Values Remittance and Hybrid Agencies on Indonesian Muslim Diaspora in Japan: A Structural-Functionalism Perspective
<b>P133</b>	Kaihei Nakamura (p:1-7)	Study of 6module X-band array antenna for Airborne CP-SAR application
<b>P137</b>	Idiani Darmawati (p:8-15)	The Effects Of Adequate Brisk Walking Exercise Toward Amount Of Pyramid Cells In The Cerebral Cortex Of Congenital Hypothyroid Pups
<b>P117</b>	Min-Wook Heo (p:16-19)	IMPLEMENTATION ON REDUCTION LUT MEMORY SIZE IN CHIRP SIGNAL GENERATION FOR SATELLITE ON-BOARD SAR
<b>P045</b>	Kageaki Inoue (p:20-27)	The archaeological investigation of the central Jawa applying the advanced remote sensing technology
<b>P162</b>	Akira Kato	Forest Disaster Monitoring using Google Earth Engine, UAV-SfM, and Terrestrial Laser Scanner
<b>P151</b>	Masuto Ebina	Relationships between topography and tree inclination: an approach using multiple time series of 3D point cloud data
<b>P136</b>	Takaaki Kobari	b-value change prior to the large earthquakes: Case study for earthquakes around Japan and the 2004 Sumatra earthquake
<b>P134</b>	Mustafa Yagmur	3D Tomographic Analysis of Ionospheric Anomalies Preceding Large Earthquakes
<b>P028</b>	Hiroki Ueno (p:28-36)	Neutron Radiation To Soft Error Hardened Latches
<b>P040</b>	Susana (p:37-41)	The Effectiveness Of Addition Nelson Traction On Microwave Diathermy (MWD) Intervention And Transcutaneous Electrical Stimulation (TENS) For Upper Thoracal Joint Blockade Pain Reduction

# Construction and Field Testing of Broadband Transceiver Modules Applied for ITS Environmental Surveillance

Elyas Palantei<sup>\*a</sup>, Wardi<sup>b</sup>, Merna Baharuddin<sup>c</sup>, Dewiani<sup>d</sup>, Nurfitri<sup>e</sup>, Lidya K Y<sup>f</sup>, MM.  
Khairul<sup>g</sup>, Eva Julia<sup>h</sup>

*a,b,c,d,e,f,g,h Telecommunication, Radio, and Microwave Engineering Laboratory  
Department of Electrical Engineering, Faculty of Engineering, Universitas Hasanuddin  
Jl. Perintis Kemerdekaan Km. 10, Tamalanrea, Makassar 90245, South Sulawesi, Indonesia*

---

## Abstract

The high complexity of the road traffic management and the vehicles mobility management is the main concerned cases to study amongst the governmental regulator and the academicians living at the big cities all over the world including Makassar city. The R&D activity presented in the manuscript outlined several interesting solutions to address the crucial road traffic problems that may also increasing in the near future encountered in the capital city of South Sulawesi Province. The modern technique, smart and effective, to control and to monitor the road traffic situations as well as the continuous observation concerned the actual events such as the potential traffic jamming, the road accident, the crime acts and so on, are the main important things and very urgent to be applied in the city. Furthermore, to improve the safety and the comfort of ITS users the availability of the up-dated info regarding the environmental conditions and the CO emission level are also very important to be monitored. The designed surveillance system to be deployed later in Makassar city intelligent transportation system consists of sensor array module and its corresponding broadband transmitter, the transmission medium (i.e. the wireless link 95 MHz and the optical cable), the broadband receiver and PC-Desktop server. Several models of a broadband transceiver module intended to be installed along the road network infrastructure to continuously monitor the road situations and to regularly transmit the collected data to the main server was experimentally tested and assessed.

## Keywords

Traffic management, Vehicle mobility management, ITS-Intelligent Transportation System, Sensor array and Environmental Surveillance

---

## 1. Introduction

A large variety of innovative models have existed globally regarding the transportation system operation and management to optimally utilise the available information and communication technology (ICT) well known as the intelligent transportation system (ITS). Based on some R & D activities that have been studied during the last decade, for instance in [1-4], the adoption of the transportation management system has increased significantly in order to maintain the better quality of the transportation network. For example, researchers from the University of Cambridge

---

<sup>\*</sup> Corresponding author Tel.: +62-81-343638241, Fax: +62-411-586015  
E-mail address: elyas\_palantei@unhas.ac.id



(UK) has developed intelligent transportation system project that covers many aspects, including monitoring activities and data collection; as well as the transmission and analysis of vehicles traffic data on the highway. In the study, there are a number of things investigated including efforts to improve the "intelligent-ePilot services", identifying assets and collecting data of the highway environments; leading edge technology applications to build better road traffic environments and the design of multimodal biometric identification system for travel documents.

There are a number of important and crucial issues influencing the transportation system in the entire territory of Indonesia. These are dominantly characterized by a variety of conditions including an increase use of vehicles on the highway which may have a significant impact on congestion to be getting worse; an increase of crime acts (such as robberies, muggings, and rapes on the vehicle), the rate of road accidents is increasing, and the potential impact of environmental pollution existed due to the continued prevalence of the use of fuelled vehicles (such as diesel and gasoline) and it is the highest probability existed still in the society. Besides, the inappropriate model of urban areas governance applied may have the significant effect on the poor quality of the transportation management system. It is therefore very urgent to optimally utilise of ICT technology to improve the real operation and management of the transportation system. In practical, there are basically two types of data/information flow should be managed in ITS network. These include flow of data/information that goes toward the centre of highway traffic management and flow of data/information out of the highway traffic management centre. There are many resources needed to build an intelligent transportation management system such as to implement and to maintain the public services system in emergency conditions existed (i.e. accidents or crime acts occur) it is therefore required the reliable communication infrastructures (i.e. mobile telephone media or fixed telephone connection) along the road must be installed and are connected to the monitoring unit station; and many more others that can be researched and developed later on. Use of other ICT devices such as cameras to monitor the speed of vehicles or real events along the way is also very important in supporting the creation of the more reliable and powerful of highway traffic management system. Besides, various types of electronic sensors such as speed sensors, electronic sensors for monitoring ambient air quality, and various types of other electronic detectors can also be integrated into the intelligent highway traffic monitoring system prototype.

Basically, the model of data/information flow that comes from highway traffic management centre should be easily accessible, inexpensive and is reliable (anytime, anywhere, and anyone). The importance of broadband communication infrastructures development for purposes of the distribution of all types of ITS information/data and to perform various functions whatsoever along the highway to users has stimulated many researchers to work on the very challenging area. Varieties innovative ITS R&D projects are required to be consistently studied and implemented in accordance with the environmental characteristics of highway in urban areas. The undergoing studies should also be adjusted with the behaviour of people who use highway (user behaviour). The prototype of the designed broadband transceiver units that are placed in locations that have been determined will then be connected via the existing optical fiber network connection available in the Metropolitan Makassar go to a main collection centre, processor and distributor of web-based server. In the study, the environmental data transmission has also utilised the broad bandwidth of wireless link connection, sequentially, to guarantee the more reliable surveillance system. Through the optimal utilization of the communications network capability that has a wide frequency operation band would allow all types of flow data/information can be exchanged and distributed to the entire highway customer with the high level of satisfaction, comfort, speed of data update and quick access. This condition will ensure the better highway transportation network management and security. By utilizing the rapid ICT technology development, the modes of communication that can be researched and developed for the

sharing and distribution of ITS data/information that is varied in terms of both the type and capacity can be performed in various applications platforms such as radio/TV broadcasting, internet media, mobile communication media, and many others.

## 2. Broadband Environmental Surveillance Network

The designed environmental surveillance system to real-timely monitoring various numbers of road traffic and its environment situation is illustrated in Figure 1. The constructed surveillance system consists of several electronic instrumentations including environmental sensors array module; switching stuff; transmitter unit; hybrid data transmission media (i.e. optical fiber and wireless links); receiver unit; the display monitoring, and recording unit.

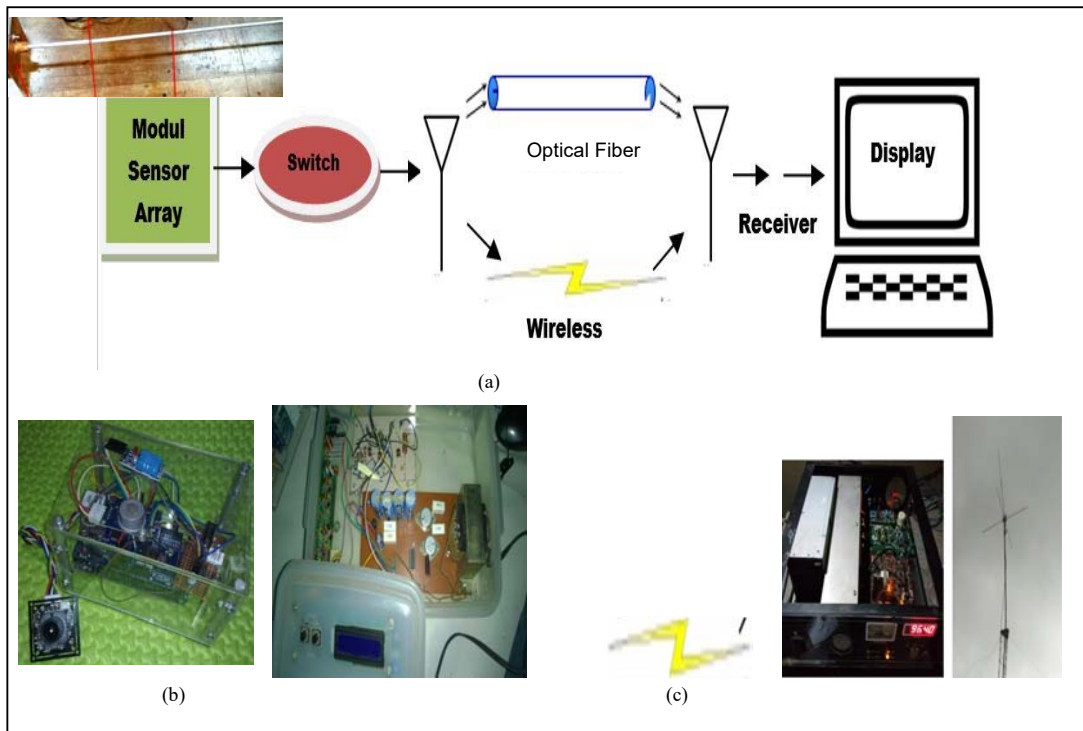

**Figure 1: A typical Broadband Environmental Surveillance Network exploiting the powerful combination of hybrid transmission media, i.e. optical fiber cable and wireless communication link.**

Various numbers of ITS data such as actual traffic intensity along the highway, the quality of exhaust emissions from vehicles (e.g. level of CO emissions), the speed of the vehicle, the potential for congestion on the highway captured through real-time CCTV network, and many more can be collected and transmitted quickly over existing optical fiber link network and received them with low of bit error rate at the central monitoring and processing station. A new strategy is offered here in the form of the application of artificial intelligence to the design of the traffic data processing systems as well as the recorded data of all the events can be monitored and the data stored on the monitoring unit center-based web server that can be accessed on-line and up-to-date. Results of the monitoring of large varieties of traffic highway parameter obtained through sensors and CCTV transducer (such as density/traffic volume of vehicles on the highway; the vehicle speed; and air pollution) are firstly processed on the motherboard to be later transmitted over hybrid telecommunications transmission networks, i.e. optical fiber

link and wireless link. The constructed broadband transceiver system is relatively inexpensive, superior performance (powerful) and reliable. The parameters of the monitoring results will be received on a transceiver unit in the data processing centre and displayed on the display monitor as a component of the system output. This process is clearly illustrated on Figure 1 (a.). Figure 1 (b) describes the fabricated prototype of the environmental sensor array module which is built-up from various electronic sensors such as Sensor DHT11, Sensor MQ7, and camera VC0706. The current visual display of all the received environmental parameters was designed using visual basic software and it is configured in such way to allow the graphical visualizations of the environmental parameter to be obtained. To guarantee the accurate sensing and data collection of the CO sensor (sensor MQ7), the carbon monoxide meter of the Extech type was used for the data comparison during the system performance testing.

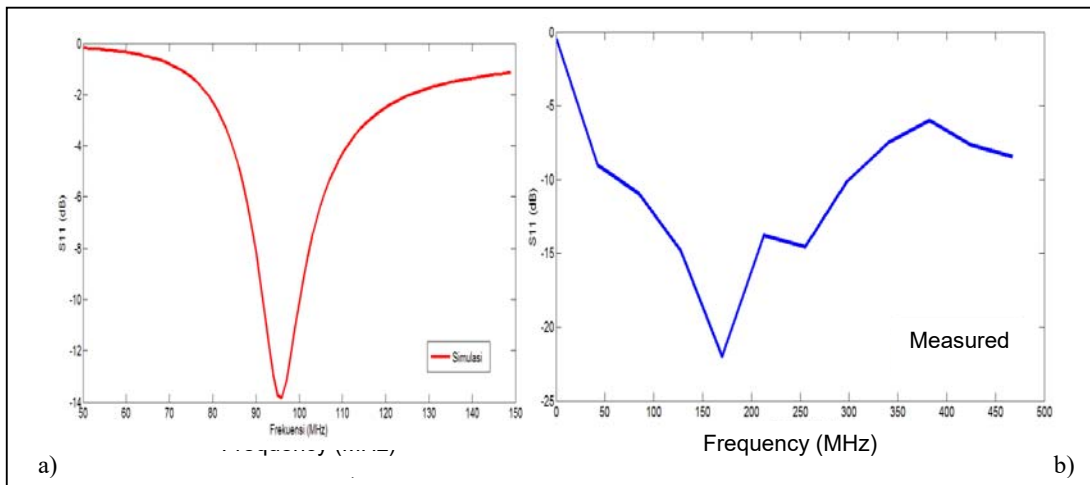

**Figure 2: The antenna system reflection coefficients deployed at one end transceiver of Broadband Environmental Surveillance.**

### 3. Performance Testing and Evaluation

In order to evaluate the electrical properties of the constructed environmental surveillance system, several experimental investigations and testing were performed. These include the testing of designed antenna system, electronic instrumentation circuits, the data transmission quality through the hybrid transmission media (i.e. optical fiber cable and wireless link) and many others. Figure 2 shows antenna system performance, both for the simulated model and the fabricated one. The antenna is a monopole wire antenna intended to apply in the frequency operation band lied from about 90 MHz up to 350 MHz. It is clearly seen that the constructed antenna allow the wide bandwidth for the data transmission from the sensor array module and transmitter to the central monitoring unit. The available impedance bandwidth of approximately larger than 350 MHz is possible to be achieved in the practical situation, even though the numerical computation shown a relatively big different performance in terms of the impedance bandwidth provided (approximately 40 MHz).

The experimental testing to evaluate the data transmission quality through the hybrid transmission media (i.e. optical fiber cable and wireless link) and to study the electrical properties of the constructed environmental surveillance system have been performed for several times. However, in this conference manuscript the results of the experiment to assess the quality of ITS environmental data transmission over the wireless link will be dominantly discussed and only little part presenting the whole

testing transmission over the optical fiber cable. Table 1 tabulates several testing results to characterize the performance of ITS data/information transmission via 96.4 MHz frequency band communication link. The experiment was set-up in such a way to study of how the actual sensed data collected through the environmental sensors array module could be transmitted from various distances (or different locations) along the highway network.

Table I Transmitting data using FM Creator 96.4 MHz transmitter on the situation no vehicles in the nearby location

Distance (km)	Time	Transmitted Data			Received Data			Receiver Vout (V)	Air Quality Category
		K (%RH)	T (°C)	CO (PPM)	K (%RH)	T(°C)	CO (PPM)		
1	02:00	64	28	26	64	28	26	1.940	Good
	02:02	64	28	26	64	28	26	1.940	Good
	02:04	64	28	26	64	28	26	1.940	Good
2	02:35	64	27	26	64	27	26	1.90	Good
	02:37	64	28	26	64	27	26	1.90	Good
	02:39	64	28	26	64	28	26	1.90	Good
3	02:45	64	28	26	64	28	26	1.87	Good
	02:47	64	28	26	64	28	26	1.87	Good
	02:49	64	28	26	64	28	26	1.87	Good
4	02:56	63	28	26	63	28	26	1.910	Good
	02:58	63	29	26	63	28	26	1.910	Good
	03:00	63	29	26	63	28	26	1.910	Good
5	03:08	63	28	26	63	28	26	1.928	Good
	03:10	63	28	26	63	28	26	1.928	Good
	03:12	63	28	26	63	28	26	1.928	Good

It is obviously known based on the above table that the whole constructed environmental surveillance system has performed in the very accurate manner during the mobile testing measured from several locations. The communication range between the local sensor array transceiver module and the centre monitoring and processing unit located at Universitas Hasanuddin campus, Tamalanrea Makassar is no more than 5 Km. Outside the area the communication quality was very poor and in the crucial condition it was disconnected. The measured ITS data described in Table I could be further processed for the purpose of analytical assessment regarding the data transmission characteristic in several parts of the entire ITS network and the results are plotted in Figures 3, 4, 5, 6 and 7.

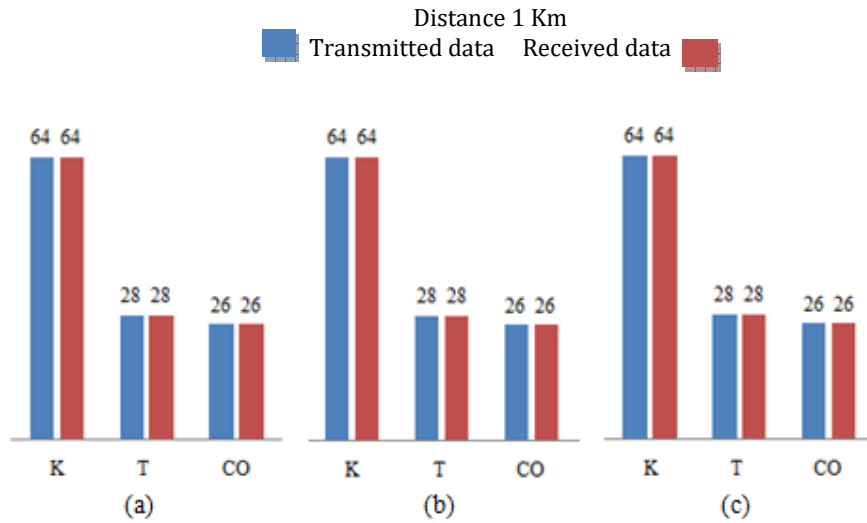

Figure 3. Graphical properties of Transmitter 96.4 MHz positioned in the distance 1 km where no vehicles presented around the area of testing (a) Time 02:00, (b) Time 02:02, (c) Time 02:04

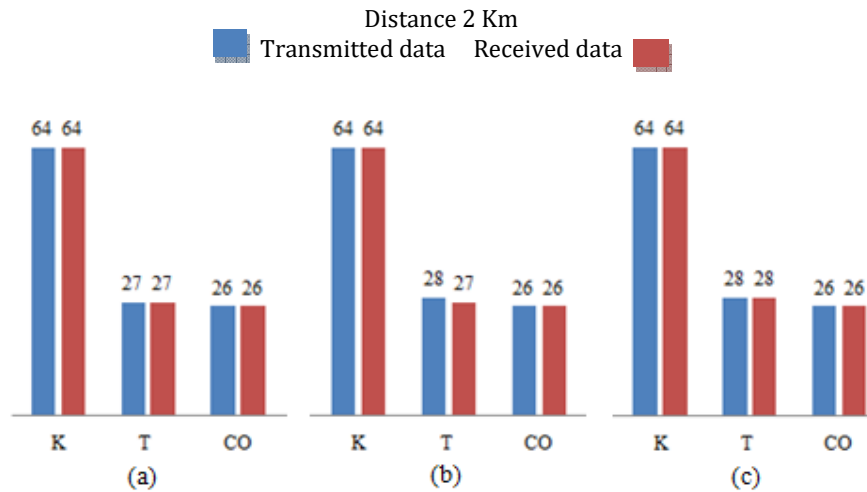

Figure 4. Graphical properties of Transmitter 96.4 MHz positioned in the distance 2 km where no vehicles presented around the area of testing (a) Time 02:35, (b) Time 02:37, (c) Time 02:39

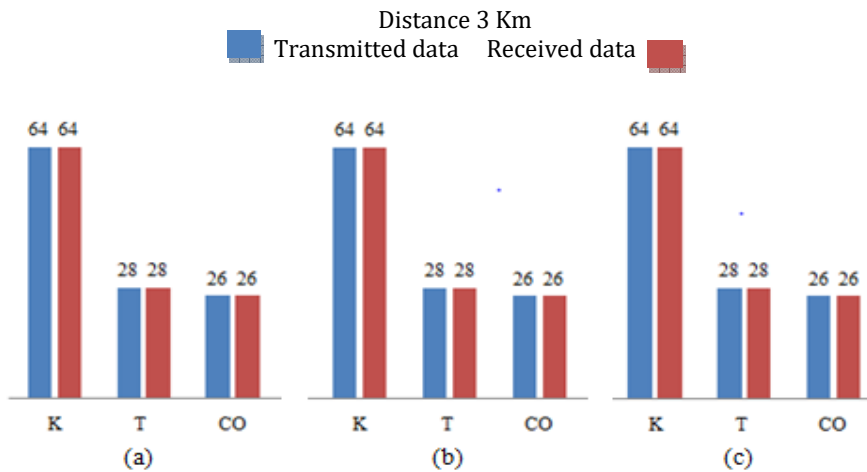

Figure 5. Graphical properties of Transmitter 96.4 MHz positioned in the distance 3 km where no vehicles presented around the area of testing, (a) Time 02:45, (b) Time 02:47, (c) Time 02:49

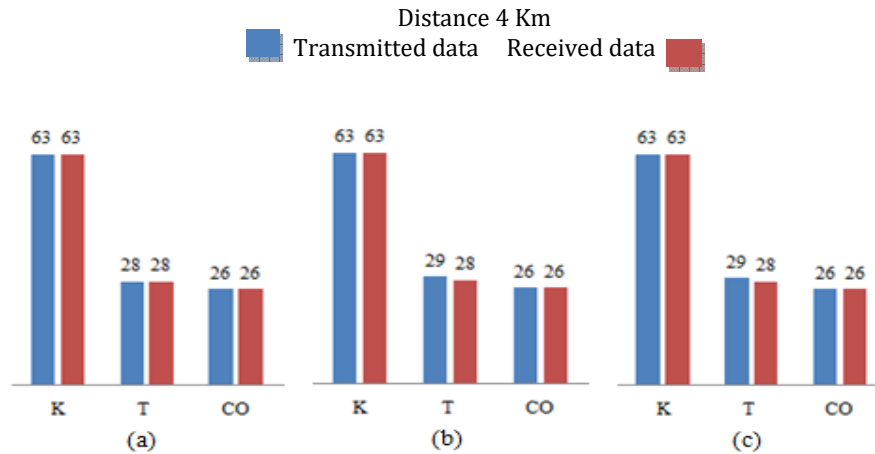

Figure 6. Graphical properties of Transmitter 96.4 MHz positioned in the distance 4 km where no vehicles presented around the area of testing (a) Time 02:56, (b) Time 02:58, (c) Time 03:00

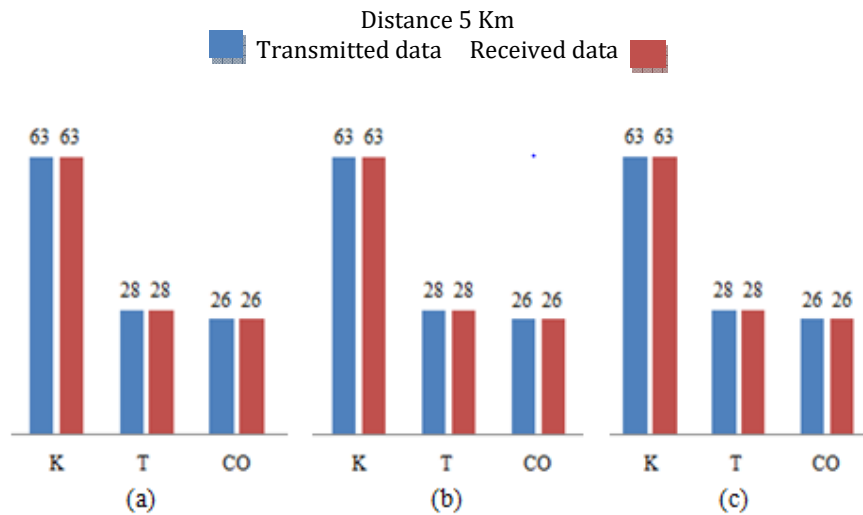

Figure 7 Graphical properties of Transmitter 96.4 MHz positioned in the distance 5 km where no vehicles presented around the area of testing, (a) Time 03:08, (b) Time 03:10, (c) Time 03:12

The whole experimental testing results described above confirm the very good operation of the designed ITS surveillance system. There were no differences between the transmitted data and the received data for the distance measurement between the remote sensors array module and the main central processing and monitoring set-up 1 Km, 3 Km, and 5 Km, for the duration of 2 minutes of transmission. Meanwhile in the distance of 2 Km and 4 Km, respectively, there were slightly differences results during the experiments especially on transmitting the temperature value  $28^{\circ}\text{C}$  and the receiving value  $27^{\circ}\text{C}$  and on transmitting the temperature value  $29^{\circ}\text{C}$  and the receiving value  $28^{\circ}\text{C}$ . The differences are highly possible caused by the existing air noise, circuit noise or perhaps due to the obstacle along the road.

## 4. Conclusion

The current designed broadband environmental surveillance system was configured to allow for the transmission of various environmental parameters representing the actual conditions of a particular intelligent transportation system developed in Makassar city. A constructed environmental sensors array incorporated with a transmitter module was used to collect a number of parameters including the visual situation of ITS (in form of picture streaming or short video file), humidity, temperature and CO level. The broad bandwidth could be provided during the transmission of those ITS data from the remote location are possibly performed using the hybrid transmission technique, i.e. wireless transmission and optical fiber transmission modes. The transmission tasks were executed sequentially and continuously using the two modes of transmission media in order the reliable transmission of various data from the remote station to the central station. Many more advanced investigations must be performed later including the testing through the optical fiber network and the development of mobile computing application to allow users for the easy real-time access to the ITS surveillance network via a mobile phone or any other smart phones.

## Acknowledgements

The authors would like to deliver our sincere thanks to any people who has the great life spirit to support and to help to implement any pieces of R&D planning program related to the development of environmental surveillance modules applicable for ITS (Intelligent Transportation System) management. The authors would also like to extend our sincere thanks to the directorate general of higher education (DIKTI), ministry of research, technology and higher education (KEMENRISTEKDIKTI) for the valuable financial support in terms of R&D grants (from 2015 to 2016) to allow more advanced innovations and a number of new findings are obtained.

## References

- A. G. P. Rahbar, "Dynamic impairment-aware RWA in multifiber wavelength-routed all-optical networks supporting class-based traffic," *IEEE/OSA Journal of Optical Communications and Networking*, vol. 2, no. 11, pp. 915-927, 2011.
- Dimitrakopoulos G., and Demstichas P., "Intelligent Transportation Systems," *IEEE Magazine on Vehicular Technology*, Vol.5, Issue 1, Maret 2010, pp.77-84.
- F.Y. Wang, C. Herget, and D. Zeng, "Guest Editorial Developing and Improving Transportation Systems," *The Structure and Operation of IEEE Intelligent Transportation Systems Society*, "IEEE Transaction Journal on Intelligent Transportation System, Vol.6, Issue 3, 2005, pp.261-264.
- I. Ramesh, S. Sundaravadivelu, "Reliable Routing and Wavelength Assignment Algorithm for Optical WDM Networks", *European Journal of Scientific Research* ISSN 1450-216X Vol.48 No.1, 2010.
- I.Mollers et al., "Plastic Optical Fiber Technology for Reliable Home Networking: Overview and Results of the EU Project POF-ALL," *Topics in Optical Communications*, IEEE Communication Magazine, Agustus 2009, pp.58-68.
- J. S. Kim, D. C. Lee, and H. Sridhar, "Route-metric-based dynamic routing and wavelength assignment for multifiber WDM networks," *IEEE Journal of Selected Areas in Communications*, vol. 24, no. 12, pp. 56-68, 2006.
- Kouji Hirata, Khamisi Kalegele, Yoshinobu Higami, Shin-ya Kobayashi, "Replica Selection and Downloading based on Wavelength Availability in  $\lambda$ -grid Networks," *Journal of Communications*, Vol 5, No 9 (2010), 692-702, Oct 2010.

S.C.K. Lye, Z.W. Siew, S. Eng Tan, C.H. Wong, and K.T.K. Wong, "A Wireless Network with Adaptive Modulation and Network Coding in Intelligent Transportation System," The sixth UKSim/AMSS European Symposium on Computer Modeling and Simulation (EMS), 2012, pp.412-417.

Xinping Yan, Hui Zhang dan Chaozhong Wu, "Research and Development of Intelligent Transportation System," The 11th International Symposium on Distributed Computing and Applications to Business, Engineering and Science (DCABES) 2012, pp.321-327.

Y. Zhao, "Mobile Phone Location Determination and Its Impact on Intelligent Transportation Systems," IEEE Transactions on Intelligent Transportation Systems," Vol.1, No.1, March 2000, pp.55-63

Zang, J. P. Jue, and B. Mukherjee, "Review of Routing and Wavelength Assignment Approaches for Wavelength-Routed Optical WDM Networks," Optical Networks Magazine Vol.1 No.1 (2008) pp. 47-60.



# FSO Propagation Noise Suppression by Applying Single-Mode Fiber Optic at The Receiving Lens Focal Point

Purnomo Sidi Priambodo<sup>1)</sup> and Ucuk Darusalam<sup>2)</sup>

<sup>1)</sup>Department of Electrical Engineering, Universitas Indonesia, Depok, 16424, Indonesia

<sup>2)</sup>Department of Informatics Engineering, Faculty of ICT, Universitas Nasional, Jakarta, 12520, Indonesia

*p.s.priambodo@ieee.org*

---

## Abstract

Free-space optical communications (FSOC) is promising technology for the future point-to-point terrestrial communication due to its capability to handle a larger bandwidth than microwave, compact, low power usage and easy to be deployed. Even, FSOC is projected for deep-space communication interplanetary. Even though FSOC has major advantages, however, the atmospheric absorption and turbulence on the optical propagation cause turbulence-induced noise and fading effects at the receiver, which finally degrading the signal to noise ratio (SNR) and increases bit error rate (BER). In order to suppress the noise and fading effects, several techniques have been proposed. The first and familiar technique is by utilizing several decision and detection electronic circuit at the demodulation block and combined by applying several space diversity receiving lenses. This technique has been developed and available commercially in the market. Another recent technique to suppress turbulence atmospheric noise and fading is by applying optical filter after the receiving lens in front of the receiving detector, instead of using electronic circuit. The optical filter used in this technique is in the form of a pinhole that has a function as a Fourier spatial low-pass filter. The advantage of applying optical filter is able to be implemented in serial combination with the electronic filter technique. In this paper, we propose to develop a new technique to suppress turbulence-induced noise by applying a single-mode fiber optic (SMFO) instead of a pinhole at the receiver lens focal point to connect with the photodetector. The SMFO functions as Fourier optics low-pass filter such as the pinhole in the previous technique. We show that the filter can improve BER performance significantly from  $10^{-4}$  down to  $10^{-8}$ , even in strong noisy medium propagation.

## Keywords

free-space optical communications, optical turbulence, noise propagation, noise fading, optical filters, spatial Fourier transforms, single-mode fiber optic, signal-to-noise ratio, bit-error-rate, noise suppression

---

## 1. Introduction

FSOC had been discussed to be the future of telecommunication since the invention of semiconductor laser in 1962. FSOC was thought to replace the microwave technology due to its superior on bandwidth capability compared to microwave. At the time, FSOC was very promising to be applied in the future for deep-space of NASA program and for terrestrial communications. However, the invention of fiber optics (FO) in 1966 and all technologies related to FO technologies later on caused the FSOC development died before deployed in the real applications. FO technology is superior compared to FSOC in many aspects includes larger bandwidth, immune to propagation noise, very longer distance of propagation and flexibility of data transmission. Even though, FO is superior in many aspects over FSOC, however, FSOC does still have some advantages over FO in these aspects: deep-space or interplanetary data transmission and the flexibility deployment of relatively short distance point to point communication to replace microwave systems. It is undoubtable that FSOC is the most possible effective technology for the future interplanetary large bandwidth communication. The flexibility and easiness deployment of FSOC such as for building

to building communication in the city and campus and its low power and compactness are several advantages of FSOC over FOs and microwaves.

Beside of thus advantageous points, however, FSOC technology has major drawbacks, which are the existence of static attenuation due to absorption and light scattering by the atmospheric propagation medium and temporal or dynamic fluctuation due to atmospheric turbulence. The static attenuation is relatively simple to be overcome by calculating link budget, the designer is able to estimate the transmitter power required for a certain distance to have a sufficient SNR at the receiver site. However, the temporal or dynamic intensity fluctuation due to atmospheric turbulence is more difficult to handle. The effect of this dynamic fluctuation signal at the receiver can be more damaging than thermal noise of the detector. Dynamic fluctuation can be in the form of phase and amplitude noise. Amplitude noise is easier to be solved electronically compared to phase noise. The atmospheric turbulence is caused by temporal and spatial temperature gradient in atmosphere. It produces various distributions of pockets of non-homogeneity optical medium as refraction zones. The turbulence creates various distributions of pockets of non-homogeneity optical medium. These medium pockets act as multiple lens effects. Micro-turbulences happen when the size of turbulences is only about a several wavelengths of the light, which cause optical scattering, attenuation and high frequency intensity fluctuation noise at the receiver, comparable to detector thermal noise. In this micro-turbulence case, the optical axis path is considered remains constant. When macro turbulence happens, it leads to deflect the optical axis from transmitter (TX) to receiver (RX) that causing beam wandering effect. The beam wandering causes slow intensity fluctuation at RX, which is called as turbulence-induced fading. The overall effects limit propagation distance and bandwidth performance of FSOC.

Turbulence-induced noise and fading at RX has been studied extensively by many researchers. Some techniques have been proposed to model Turbulence-induced noise and fading. At least there are 2 important statistical parameters related to turbulence-induced noise and fading, i.e. (1)  $d_0$ , the correlation length of random intensity fluctuation and (2)  $\tau_0$ , the correlation time of random intensity fluctuation. Several detection techniques have been proposed based on those two statistical properties of turbulence-induced noise and fading. The two are temporal or spatial-domain technique approaches. In spatial-domain technique, at RX side, it is proposed the spatial-aperture averaging method, which is in the form of spatial diversity method that is applying both multi TXs and multi RXs. This is called multi-input multi-output (MIMO) and combined with Q-ary pulse-position modulation (QPPM) [13]. Several research groups have achieved in developing FSOC for middle distance up to 1-km with 10-Gbps bit rate. In temporal domain technique approach, RX should be designed such that RX observation interval  $T_0 > \tau_0$ , where turbulence-induced noise can be much reduced by temporal-averaging method at the RX. In the same way, for spatial domain technique approach, RX aperture diameter  $D_0 > d_0$ , such that turbulence-induced fading can be much reduced by spatial-aperture averaging method at RX.

In this paper, we propose a different way to overcome the turbulence-induced noise on FSOC. Instead of suppressing the turbulence-induced noise by using temporal and spatial-domain statistical technique approaches as explained above, we propose to use Fourier optics filter concept. Atmospheric turbulence along the propagation medium produces a high frequency temporal and spatial fluctuated wavefront right in front of the RX lens. The high frequency temporal and spatial fluctuated wavefront based on Fourier optics analysis concept, consists of fundamental and higher-order spatial harmonic planar wavefronts. Higher-order spatial harmonic planar wavefronts means making larger angle to the optical axis such as shown in Fig.1. The temporal noise mostly rides on the higher-order ones. In our previous research, we use pinhole as a low pass Fourier optics filter, which is common to be used in interferometric process to suppress the higher-order spatial harmonics (consisting noisy signal parts) of the receiving turbulence-induced noise. However, in this paper we proposed to use a single-mode fiber optics (SMFO) instead of pinhole to filter the turbulence-induced noise. After a SMFO filter, the detector receives a clean signal, which is the fundamental order of optical carrier modulated by the information signal. In this paper, suppression is limited on high frequency fluctuation noise and not the fading, due to the limitation of our computation and simulation experiment.

## 2. Noise Suppression Analysis

The received wavefronts as noisy information carrier is received by the receiving lens aperture, and focused onto the detector. The ideal condition is that the receiver lens diameter  $D_0 \gg d_0$ . However, mostly the condition is  $D_0 < d_0$ . The limitation of receiving aperture diameter causes RX lens focusing system cannot perfectly average the received noisy wavefront in order to clean the noise. At the focal point, the light beam looks like a waist. It will have many of focusing waist as the results of the higher order spatial wavefronts caused by turbulence-induced noise and fading as shown in Fig.1. For a detector that has an area larger than the beam waist area and located right behind the focal point, then the overall received signal that consists of temporal noises and the original signal will be detected by detector. This decreases SNR and increases BER.

The received noisy wavefront is constructed by superposition of fundamental clean signal and noisy harmonic planar wavefronts, which propagate off the optical axis, as shown on Fig.1:

$$U(x, y) = \iint F(v_x, v_y) \exp[-j2\pi(v_x x + v_y y)] dv_x dv_y \quad (1)$$

$$P_r = \iint |U(x, y)|^2 dx dy \quad (2)$$

where  $v_x$  and  $v_y$  are the spatial frequencies in  $x$  and  $y$  directions in  $x$ - $y$  plane, respectively and  $F(v_x, v_y)$  is the amplitude of the mixing spatial frequencies and  $U(x, y)$  is the total electromagnetic field at point  $(x, y)$ . The total received power at receiving lens is  $P_r$  and the fundamental or clean signal power is  $P_0$ . The SNR without filtering is expressed as,

$$SNR = \frac{P_0}{P_r - P_0} \quad (3)$$

The receiving lens works as a spatial Fourier transformer. It transforms the temporal-spatial noisy input wavefronts to be spatially harmonic focal points on the focal-point plane. On the focal point plane of the receiving lens exists various focal points of each harmonic planar wavefronts surrounding the center of the fundamental focal point, such as shown in Fig.1. In this filtering process, a SM fiber optic works to block the higher-order spatial harmonic focal points. Only fundamental order wavefront can pass the SM fiber optic to reach the receiving detector. In this case, SM fiber works as a Fourier optics low-pass spatial filter. It blocks higher-order spatial harmonics, which are overridden by temporal noise at focal points.

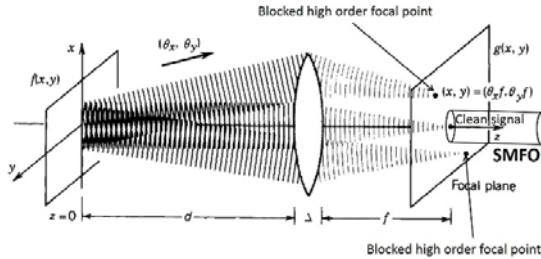

Fig.1. Single-mode fiber optic blocks higher-order spatial harmonic focal-points.

SM fiber suppresses the noise and improves the receiving SNR. Only fundamental spatial order that brings clean information signal is expected to be detected by the receiving detector. The SNR by using SM fiber filter will be drastically increased, even though the total receiving power decreases. SM fiber is located behind the focal point, as shown on Fig.2. The SM fiber diameter has to be equal or slightly larger than the beam waist, in order that the whole clean signal can be detected, while the higher-order spatial harmonics are blocked. The relationship between receiving lens and beam waist radius at focal-point is formulated in the following Eq.(4).

$$D_0 \approx \frac{4\lambda}{\pi D} f \quad (4)$$

where  $D$  is the receiving wavefront diameter right in front of the receiving lens.  $D_0$  is the beam waist diameter at focal point,  $f$  is the focal length and  $\lambda$  is the wavelength. In this experiment, the receiving beam diameter is 5-cm and focal distance is 15-cm, then the beam waist diameter at focal point is  $3.82\lambda$ . The SM fiber core diameter sizes are from 5 to 8  $\mu\text{m}$ . This size is a bit larger than beam waist diameter. If SMFO is located in the exact focal point, the only consideration is that the

beam waist width should be design such that a bit smaller than SMFO core diameter, to make sure that all the clean fundamental order signal captured by the SMFO. If SMFO is located before and after focal point than the numerical aperture of SMFO should be considered. It is very recommended that the SMFO tip should be located in the area around the focal point or extended at least about Rayleigh range or a half of depth of focus as shown in the following Fig.2. The Rayleigh range ( $z_0$ ) is expressed as,

$$z_0 = \frac{\pi D_0^2}{4\lambda} \quad (5)$$

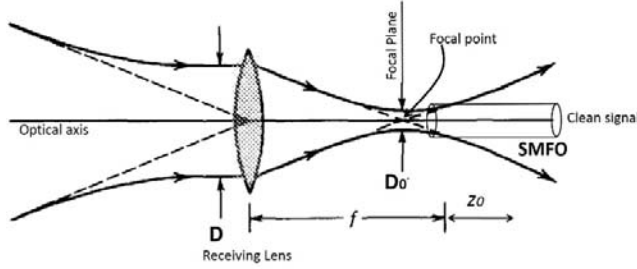

Fig.2. Receiving lens and single-mode fiber optics alignment.

To estimate the SNR gain due to SM fiber filtering effect and to simplify derivation, it needs to assume that the noise power is distributed equally from low to high spatial frequency noise. SNR gain is defined as an SNR comparison between SM fiber core and avalanche photodiode (APD) detector diameters. Assuming that the fundamental clean signal waist radius is  $R_0 = 0.5 D_0$  at focal plane of receiving lens and  $R_1$  is SM fiber and  $R_2$  is APD radii, by recalling Eq.(3), then the SNR gain can be formulated as:

$$SNR_{Gain} = \frac{R_2^2 - R_0^2}{R_1^2 - R_0^2} \quad (6)$$

To estimate BEP, it needs to assume that the turbulence channel is a log-normal distribution model as a representation of weak-turbulence inside the propagation simulator box. The spatial spectral distribution as a result of Fourier optical transformation by the receiving lens should represent the probability density distribution of the receiving signal. The modulation is on-off keying (OOK). By assuming that the noise due to turbulence is a Gaussian distribution and larger than the receiver noise figure, then the bit-error probability (BEP) can be derived as following.

$$N_0 = \sigma_N^2 = \frac{P_r - P_0}{\pi(R^2 - R_0^2)} \quad (7)$$

$N_0$  or  $\sigma_N^2$  is noise intensity due to turbulence or signal covariance at the focal plane of the receiving lens.  $P_r$  is total received power and  $P_0$  is the fundamental clean signal.  $R$  and  $R_0$  are radii of beam waist of total signal and fundamental signal, respectively at the focal plane of the receiving lens.

The following is BEP derivation, since the signal '1' and '0' are equally likely to be transmitted, then the overall average probability of error is

$$P_e = \frac{1}{2} P(e|'1') + \frac{1}{2} P(e|'0') = \frac{3}{2} Q \left[ \sqrt{\frac{E_b}{2N_0}} \right] \quad (8)$$

The probability of error  $P_e$  or sometimes is called as bit error probability (BEP) is the expectation value of bit error rate (BER). The value of  $E_b/N_0$  is simply corresponded with SNR. Then Eq.(8) can be written as

$$BEP = \frac{3}{2} Q \left[ \sqrt{\frac{1}{2} SNR} \right] \quad (9)$$

The BEP improvement ( $BEP_{Gain}$ ) of the small radius pinhole  $R_1$  in comparison to the large radius pinhole  $R_2$  is written as:

$$BEP_{Gain} = \frac{3}{2} Q \left[ \sqrt{\frac{1}{2} SNR_{Gain}} \right] \quad (10)$$

### 3. Experiment

The experiment in laboratory set-up shown on Fig.3 is to prove noise suppression by SMFO. This set-up is designed for wavelength of 1550-nm, which is the best wavelength for terrestrial FSOC propagation. It is intended to prove the improvement of BER performance for FSOC using SMFO filter. The propagation simulator box as shown, consists of 2 types of propagation channels, one is affected by air turbulence due to air flow through obstacles and water vapor (as shown as upper part). The second one is not affected by turbulence unless beam divergence less than  $5^\circ$  (the lower part). The overall dimension of the box is 4m x 1m x 0.5m. The in-flow air has temperature of  $14^\circ\text{C}$ , while the hot water vapor has temperature of nearly  $100^\circ\text{C}$ , sufficient to create multiple lens scattering and absorption effects. For this experiment, we assume it is sufficiently to model a weak-turbulence condition that fit to a log-normal distribution.

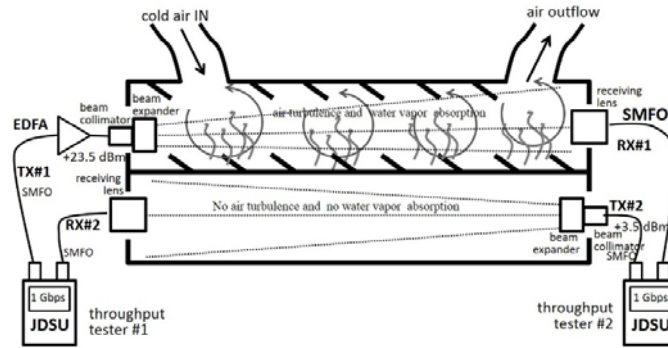

Fig.3. Experiment set-up for filtering turbulence-induced noise by SMFO. The set-up uses Erbium-doped fiber amplifier (EDFA) 26.0 dB gain with maximum output 23.5 dBm and JDSU is a brand of 1 Gbps full-duplex TX-RX and BER-meter.

### 4. Discussion and Analysis

Due to limited number of fiber optic type available, we did experiment once with 9- $\mu\text{m}$  single-mode fiber optic core. First, we do measurement on turbulence propagation inside the propagation simulation box, the receiving signal is focused directly on the APD detector with 1 Gbps data rate, the measuring result is BER  $10^{-4}$ . However, once we apply single-mode fiber optic as Fourier optic low-pass filter, the resulting BER measurement is drastically reduced to  $10^{-8}$ . It proves our proposed hypothesis that SMFO filter will block more higher-order spatial harmonics, which are overridden by temporal noise. It agrees with the theoretical derivation as well.

The weakness of SM fiber optics implementation for optical noise filtering is in the condition when beam wander occurs as the result of atmospheric turbulence. SMFO filtering system is not immune from beam-wander effect, the system will temporally be misaligned and produce fading effect. In order to take the benefits of SM fiber optics advantages in suppressing high-order spatial noises and to avoid the weakness from beam-wander effect, our research group, since two years ago has developed detection system by replacing pinhole and SMFO with charge-coupled device (CCD) array detector and controlled by low-pass Fourier optics filter signal processing algorithm.

### 5. Conclusion

A new idea of propagation noise suppression in FSOC, by using a single-mode fiber optic as a Fourier optics low-pass filter has been presented. By simulation, it has been proven to improve BER performance in medium turbulence-induced fading propagation from  $10^{-7}$  down to  $10^{-11}$  (up to  $10^{+4}$  BER improvement), even more. Furthermore, this proposed filtering method can also be implemented for applications with longer wavelength such as in RF technologies to suppress the propagation noise due to turbulence atmosphere.

## ACKNOWLEDGEMENT

This work is funded by research grant BOPTN Universitas Indonesia 2014 and PUPT Universitas Indonesia 2015. The authors declare that there is no conflict of interests regarding to the publication of this manuscript and this manuscript is original work.

## REFERENCES

- B.E.A. Saleh and M.C. Teich, "Fundamentals of Photonics," *A Wiley-Interscience Publication, John Wiley and Sons, Inc.* Ch. 4 "Fourier Optics", (1991) pp. 108–156.
- C. A. Rjeily and A. Slim, "Cooperative diversity for free-space optical communications: transceiver design and performance analysis," *IEEE Trans. Commun.* 59 (2011) 658–663.
- C.C. Davis, I.I. Smolyaninov and S.D. Milner, "Flexible optical wireless links and networks," *IEEE Communications Magazine*, 41 (2003) 51-57.
- Dupuis, Russell D. "Special issue papers: An introduction to the development of the semiconductor laser." *IEEE Journal of Quantum Electronics* 23.6 (1987).
- H. Hemmati, A. Biswas, I.B. Djordjevic, "Deep-Space Optical Communications: Future Perspectives and Applications," *Proceedings of the IEEE*, 99 (2011) 2020–2039.
- H. Kaushal, V. Kumar, A. Dutta, H. Aennam, V. K. Jain, S. Kar, and J. Joseph, "Experimental Study on Beam Wander Under Varying Atmospheric Turbulence Conditions," *IEEE Photonics Technology Letters*, 23(22), pp. 1691–1693, November 2011.
- Hennes Henniger, "Transmission Performance Analysis of Free-Space Optical Communications using Gilbert-Erasure Channel," *IEEE Transactions on Wireless Communications*, 60 (1), pp. 55–61, January 2012.
- Jin Cheng, Yong Ai, and Ying Tan, "Improved free space optical communications performance by using time diversity," *Chin. Opt. Lett.* 6, pp. 797–799, 2008.
- J.G. Proakis and M. Salehi, "Communication Systems Engineering," *Prentice Hall, Englewood Cliffs, New Jersey 07632*, (1994).
- K. Wakamori, K. Kazaura, and Ikuo Oka, "Experiment on regional broadband network using free-space-optical communication systems," *J. Lightw. Technol.* 25(2007) 3265–3273.
- L.C. Andrews and R.L. Phillips, "Laser Beam Propagation Through Random Media", SPIE Press, 2<sup>nd</sup> Ed, Bellingham, Washington, USA, (2005)
- M. Ijaz, Z. Ghassemlooy, J. Perez, V. Brazda, and O. Fiser, "Enhancing the Atmospheric Visibility and Fog Attenuation Using a Controlled FSO Channel," *IEEE Photonics Technology Letters*, 25(13), pp.1262–1265, July 2013.
- M. A. Khalighi, N. Schwartz, N. Aitamer, and S. Bourennane, "Fading reduction by aperture averaging and spatial diversity in optical wireless systems," *J. Opt. Commun. Netw.*, 1 (6), pp. 580–593, Nov 2009.
- P. S. Priambodo, U. Darusalam, and E. T. Rahardjo, "Free-space optical propagation noise suppression by Fourier optics filter pinhole," *International Journal of Optics and Applications*, vol. 5, pp. 27–32, (2015).
- Shlomi Arnon, "Effects of atmospheric turbulence and building sway on optical wireless-communication systems", *Optics Lett.*, 28(2003)129–131.
- S. M. Navidpour, M. Uysal and M. Kavehrad, "BER Performance of Free-Space Optical Transmission with Spatial Diversity," *IEEE Transactions on Wireless Communications*, 6 (8), pp. 2813–2819, August 2007.
- Stephen G. Wilson, Maite Brandt-Pearce, Qianling Cao and James H. Leveque, "Free-Space Optical MIMO Transmission With Q-ary PPM," *IEEE Trans. on Commun.*, 53(2005)1402–1412.
- Xiaoming Zhu and Joseph M. Kahn, "Free-Space Optical Communication Through Atmospheric Turbulence Channels," *IEEE Trans. on Commun.*, 50(2002)1293–1300.

# Design and Analysis of Mesh Network for Ship-to-Ship Maritime Communication using IEEE 802.11 on Maritime Environment of Tanjung Perak – Indonesia

Ahmad Fauzi Makarim<sup>a</sup>, Okkie Puspitorini<sup>b</sup>, Hani'ah Mahmudah<sup>c</sup>

<sup>abc</sup> Departement of Electrical Engineering  
Electronic Enggining Polytecnic Institute of Surabaya (EEPIS)  
Surabaya, Indonesia

---

## Abstract

Maritime communication systems with terrestrial connectivity make the limitations of the transmitter from the harbor to ships that are out of reach. Relative to the maritime mesh network is one effort that could be used in addressing the issue. In designing the maritime mesh networks, there are several steps that need to be done is to analyze the signal propagation characteristics above sea level in advance to determine the exponent  $n$  factor to determine the signal-transmission losses in the region. Based on the parameters of wave height in the territorial waters of Tanjung Perak Harbor at Surabaya obtained value  $n$  exponnet valuable 2.5494- 3.3365 and transmitter coverage area of 4,65 Km. The value of coverage referenced in the design of maritime mesh network. Where the predetermined scenario then the nodes will be interconnected if the node is at the coverage area. But for nodes that are not connected to the other node because it is not included in the coverage, then used the Djikstra algorithm glittering of mesh network connectivity with the nearby track consideration.

## Keywords

Maritime communications, Ship-to-ship,  $n$  exponent, Mesh Maritime, Djikstra Algorithm

---

## 1. Introduction

As a maritime country where most of the territories consist of seas, Indonesia is related with the use of the seas as media of sea transportation and the usage and the management of sea potential. Therefore, Indonesian government realizes that the management of Indonesian seas is important, and one is issued at Rakornas Kominfo at Novermber 20<sup>th</sup> 2014 by Dirjen SDPPI that is about the infrastructure of maritime radio communication which is not adequate enough. [1]. Wireless technologies are widely used for terrestrial land systems providing speeds close to 1 Gbit/s in 4G cellular networks with users enabled with access in the order of tens or even several hundred Mbit/s. However, in the maritime environment, transmission speed is still in the order of several tens or several hundreds kbit/s [2].

Due to the location of the ship at sea, this time using a cellular system or a wireless point-to-point, where the vessel will be profitable only in certain areas, such as a busy port, because base stations typically provide sufficient coverage with a single hop transmission. At this time it is difficult to provide communications to ship outside of cellular coverage. Mesh network technology can be used to overcome the nodes that are outside cellular coverage.

In connection with this, then not only the ports that need to be designed with sufficient system, but on each vessel must be equipped with adequate infrastructure and systems that each ship can get in touch with a good and fast though outside the coverage area of the port.

At the end of this project will be devoted to building network system among vessels that have large bandwidth that can support the implementation of communication technology quickly and efficiently. A network is a mesh network designed using the IEEE 802.11 technology. With built infrastructure is expected to facilitate mobile Internet users on the ship to communicate in the waters territorial.

## 2. Ease of use

### 2.1. Channel Model Of Maritime Path Loss

Radio wave propagation which consider sea surface factor is an important thing for receiver. At radio wave propagation on sea surface can be found a consideration about sea level factor. The height of sea wave is different based on its geographic condition.

The path loss in the maritime environment increases with the sea state, and it increases rapidly in sea state 5 and above. According to Timmins et al. [5], the path loss in the maritime communication channel during shadowing is as follows:

$$PL(h, f) = PL(d_0) + 10 \times [(0.498 \log_{10}(f) + 0,793) \times h + 2] \times \log_{10}\left(\frac{d}{d_0}\right) X_f \quad (1)$$

where  $f$  is the frequency in GHz, the observable sea height is  $h$  in meters,  $d$  is the physical distance between the transmitter and receiver in meters and  $PL(d_0)$  is the path loss simulated at 1 m and the random variable,  $X_f$ , with zero mean and standard deviation,  $\sigma_f$ , which is also represented as a function of wave height:

$$\sigma_f = [0.157f + 0.405] \times h \quad (2)$$

### 2.2. Maritime Broadband Wireless Mesh Network

Based on the report of ITU-R M 2202 maritime mesh network design is looks like the figure 1.

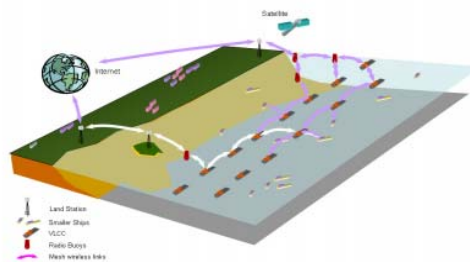

Figure 1 Maritime Mesh Network design ITUR-M 2202

In the report, described the results of experiments and measurements of maritime communication system with scenario of shore-to-ship which is done in Singapore and scenarios ship-to-ship conducted in Norway. Report of the results of ITU-R M 2202 it was concluded that An ideal broadband access for maritime communication based on mesh networks might need spectrum bandwidth in the



order of tens of MHz. Operational frequency bands for broadband maritime mesh networks may be designed to operate in frequency bands such as VHF, UHF or SHF. However, it may be difficult to find sufficiently wide and dedicated spectrum at frequencies lower than 1 GHz, which is more ideal for maritime application. However, a maritime mesh system might not require a single dedicated harmonized band to ensure operation, if the mesh system is frequency agile. This could be achieved through multi-band operation, software defined radio or cognitive radio technologies. Geo-location information provided by GPS could also be used with the mesh radio for selection of suitable radio frequencies within a region or an area. Although this document describes the tests carried out at 2.3 GHz and 5.8 GHz, identification of suitable bands for the maritime mesh system requires further study [2]

### 3. Metodology

Characteristic of signal propagation over the sea was different than terrestrial. On the sea area one of the signals reflected on the water, where the water was moving and has a changeable height. It can be affect the rate of propagation. In this research it using several steps in the methodology. *First*: Analyzed of the propagation area, *Second*: finding the theoretical and special formula of signal propagation on sea surfaces.

Where the analysis of the propagation characteristics of the sea has a parameter losses which depend  $n$  exponent parameter on each region. By using the formula  $n$  exponent factors ocean waves are in the testing area, namely Tanjung Perak Harbor at until Karang Jombang island . So the path loss value is determined based on the region. From the path loss value is then used as one of parameter in determining the coverage area of the transmitter. Where the coverage area of this transmitter is used a reference in designing the maritime mesh network.

#### 3.1. Analysis of characteristics propagation over the sea

##### 1) Determine of Path Loss Exponent

On the path loss of sea waves one input parameter is the height of the wave, where the wave height is entered based on data from BMKG Surabaya on the working area of Tanjung Perak Surabaya into Karang Jombang Island. In the study [5] explained that the wave height factor has affected of maritime communication system, from the research are translated into the value of path loss as in figure 2.

$$\begin{aligned}
 & \boxed{LT(d)} = \boxed{L_s(d_o)} + \boxed{10} \boxed{\alpha} \boxed{\log_{10}(d/d_o)} + \boxed{X_f} \\
 & \boxed{PL(h, f)} = \boxed{PL(d_o)} + \boxed{10} \times \boxed{[(0.498 \log_{10}(f) + 0.793) \times h + 2]} \times \boxed{\log_{10}(d/d_o)} + \boxed{X_f}
 \end{aligned}$$

Figure 2 Analysis Of Equation

From the analysis of the equation in figure 2 the value of path loss exponent  $n$  is equal to:

$$\alpha = [(0.498 \log_{10}(f) + 0.793) \times h + 2] \quad (3)$$

Based on the data obtained from BMKG then the value of the wave height (h) averaged per month and put into the general equation of the path loss exponent to get the value of path loss overall in table 1.

Table 1. *n* exponent each month

Month	Average of <i>h</i> (meter)	PL( <i>h, f</i> ) (dBm)	Path loss exponent ( $\alpha$ )
September 2014	0.8733	91.9417	3.0727
October 2014	0.41	89.6959	2.7053
November 2014	0.21333	88.7426	2.5494
December 2014	0.5516	90.2823	2.8176
January 2015	1.206	93.5543	3.3365
Februari 2015	0.886	92.0032	3.0828
March 2015	0.506	90.1613	2.7814
April 2015	0.333	89.3227	2.6443
May 2015	0.661	90.9126	2.9044
June 2015	0.697	91.0871	2.9329
July 2015	0.9	92.0711	3.0939
August 2015	0.923	92.1826	3.1121
September 2015	0.8097	91.6334	3.0223

The value of path loss exponent is 2.5494- 3.3365 monthly basis or on average produces path loss exponent value equal to 2.4668. The table of results shows that the path loss is the smallest value of 2.5494 which occurred in November with the average wave height is 0.21333 meters. and the highest value of path loss is 3.3365 which occurred in January with a wave height reaches 1,206 meters. So it can be analyzed that affect wave height of signal propagation system, where the higher the waves on the maritime environment, the value of the resulting path loss even greater.

## 2) Determine of coverage area

Coverage is the range of transmission system where the determiner of the coverage value based on the meeting point of transmission level and the sensitivity of the device. Calculation of received power level is determined by using the device specifications wifi outdoor which has the specs as follows:

Table 2. *Specifications od device (system parameters)*

Frequency	:	5.8 GHz
Trasmitter power	:	23 dBm
Antenna gain of Tx	:	13 dBi
Antenna gain of Rx	:	13 dBi
Sensitivity power of Rx	:	-94 dBm

The value of path loss and received power level was tested by using a distance function to find the value in the point of intersection between the received power level at a distance function with constant sensitivity value is -94 dBm. Then these values are used as a benchmark in determining the coverage area of a transmitter. In the study litelature method which uses high parameter wave has produced a value *n* of 3.3365. the value is then incorporated into the general formula path loss exponent so that the function of distance path loss value generated is shown in Figure 3 :

<b>a</b>	<b>b</b>
----------	----------

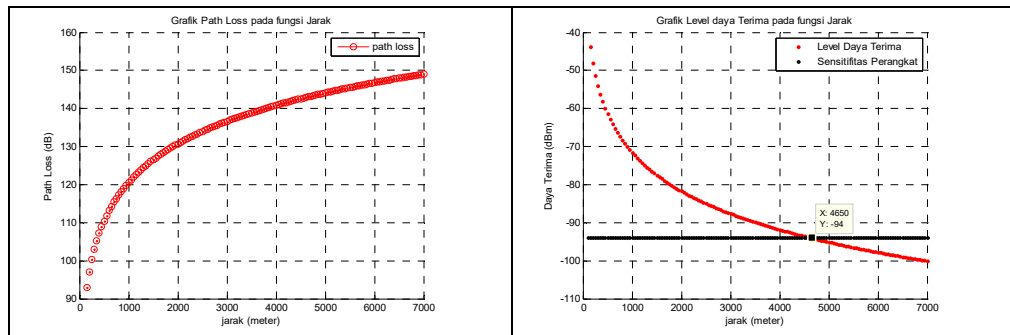

Figure 3. (a) Path Loss chart on  $n=3.3365$ ; (b) Coverage chart on  $n=3.3365$

Figure 3 (b) is a graph of received power level when the value of  $n$  is 3.3365 based on wave height factor. That then the picture has seemed to point to the value of 4650 which is the distance at which the value of received power level intersected with values of sensitivity, so the value of 4650 meter or 4.65 Km is the value of the coverage area of the transmitter.

### 3.2. Maritime mesh network design

Having in mind the characteristics of the propagation of the maritime environment, so that the coverage be obtained from either the transmit power of each transmitter transmitter is in port or transmitter on board. The design of the system of maritime mesh network created the diagram block. Its includes several stages there are:

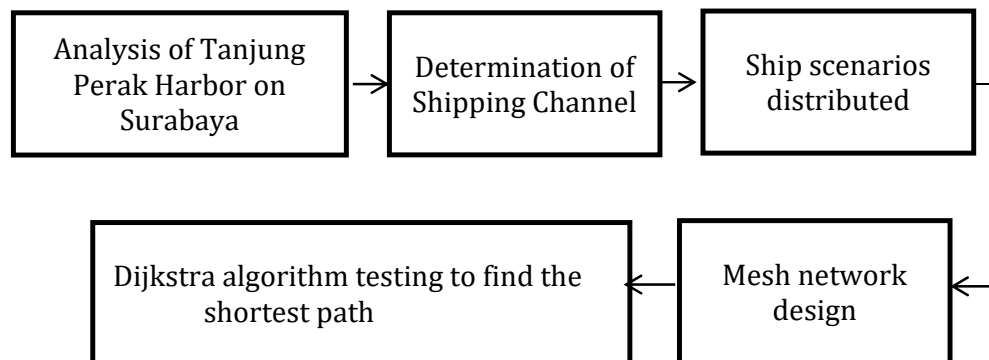

Figure 4 Block Diagram Of Mesh Networks Maritime Design

#### 1) Analysis of Tanjung Perak Harbor on Surabaya

To analyze maritime area in Tanjung Perak to Karang Jamuang Island, two parameters used which are average wind rate and average wind height at the area which is obtained from BMKG Surabaya. The average wind height in that area is about 0.2-1.3 m, while the average wind rate is about 2-7 Knots. With the result of both the data, can be determined that the maritime of Tanjung Perak harbour to Karang Jamuang included in sea state 1 and state 2.

#### 2) Ship scenarios distributed

Made of ship scenario distributed from Surabaya Tanjung Perak Surabaya into Karang Jamuang Island. Ship node scenario is based on ship route from Tanjung Perak Surabaya to Karang Jamuang Island roomates is legalized by District Navigation Office Class 1 Surabaya, West Java- Indonesia.

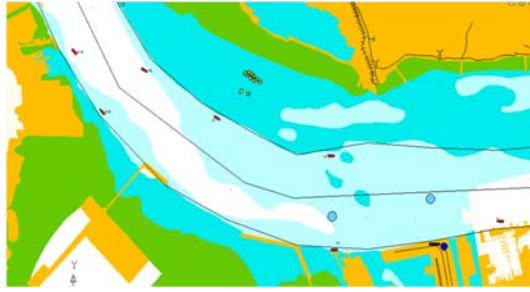

Figure 5 Scenarios For Testing Network Node

#### 4. Analysis system

##### 4.1. Maritime mesh network design

The mesh network is a network topology that form a link between devices where each device is connected directly to others devices in the network. In a mesh network design first thing to know is the value of the coverage of the transmitter. It is used to determine which nodes are located within the coverage which is then connected to the transmitter node.

By using the value of the coverage that is predetermined based on the real conditions in the testing area, the next step is to determine the value of the distance to each node that has been scripted by the permission of the district office first class navigation Surabaya. By using equation (4) between node distance value can be determined in formula 4.

$$d = 2r \arcsin \left( \sqrt{\sin^2 \left( \frac{\varphi_2 - \varphi_1}{2} \right) + \cos(\varphi_1) \cos(\varphi_2) \sin^2 \left( \frac{\lambda_2 - \lambda_1}{2} \right)} \right) \quad (4)$$

where :

- d = the distance between the two point coordinates
- r = the radius of the earth (6371 km)
- $\varphi_1$  = coordinate of latitude 1
- $\varphi_2$  = coordinate of latitude 2
- $\lambda_1$  = coordinate of longitude 1
- $\lambda_2$  = coordinate of blongitude 2

Each node in scenarios calculated using equation (4) so as to produce a list of tables containing the value distance between nodes.

Table 3. Distance between the nodes

	X1	X7	X18	X19	Y4	Y7	Y9
X1	0	2.962	7.198	7.908	3.116	5.198	6.631
X7	2.962	0	4.552	5.406	1.379	2.800	4.221
X18	7.198	4.552	0	0.992	4.104	2.045	0.962
X19	7.908	5.406	0.992	0	4.791	2.713	1.285
Y4	3.116	1.379	4.104	4.791	0	2.083	3.515
Y7	5.198	2.800	2.045	2.713	2.083	0	1.454
Y9	6.631	4.221	0.962	1.285	3.515	1.454	0

\*Value on kilometer

In table 3 is a value of the distance between nodes to all nodes based scenarios. By using one of the parameters of coverage is the coverage

measurement equal to 4.78 Km, the values in Table 3 are given marks in red are the nodes arriving at the transmitter coverage.

Then to design the mesh network nodes red marked all its value is replaced with a value of 0, while the node that is not marked with red all grades replaced with a value of 1. Where the purpose of giving a value of 0 is not connected node, while the node value of 1 is mutual connected.

Table 4. Mesh network connectivity table

Node	X1	X7	X18	X19	Y4	Y7	Y9
X1	1	1	0	0	1	0	0
X7	1	1	1	0	1	1	1
X18	0	1	1	1	1	1	1
X19	0	0	1	1	0	1	1
Y4	1	1	1	0	1	1	1
Y7	0	1	1	1	1	1	1
Y9	0	1	1	1	1	1	1

Where the nodes are interconnected by Table 4 is a table of the mesh network connectivity. Node node X1 is only connected to X7 and Y4, but the X7 node connected to all nodes except the node Y4. This happens because the node X7 are almost in the center of the entire node.

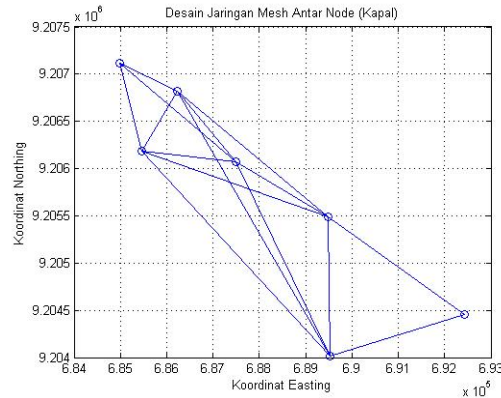

Figure 6 Mesh Network

#### 4.2. Testing of djikstra algorithm

The mesh network is a network topology that form a link between devices where each device is connected directly to others devices in the network. In a mesh network design first thing to know is the value of the coverage of the transmitter. It is used to determine which nodes are located within the coverage which is then connected to the transmitter node

Link state routing protocol uses the shortest path problem (shortest path) to determine the best path from sender to destination. The problem is one of optimization problems and graphs used in the search of the shortest path is a weighted graph. To solve these problems the algorithm can be used dijkstra.

Tables with red color indicates that the node outside of coverage, so it can be converted into infinity symbol ( $\infty$ ) and become the new table

Table 5. Distance value between node

Node	X1	X7	X18	X19	Y4	Y7	Y9
------	----	----	-----	-----	----	----	----

X1	0	2.9627	∞	∞	3.1168	∞	∞
X7	2.9627	0	4.5524	∞	1.3797	2.8002	4.2219
X18	∞	4.5524	0	0.9925	4.1049	2.0451	0.9626
X19	∞	∞	0.9925	0	∞	2.7137	1.2858
Y4	3.1168	1.3797	4.1049	∞	0	2.0836	3.5159
Y7	∞	2.8002	2.0451	2.7137	2.0836	0	1.4549
Y9	∞	4.2219	0.9626	1.2858	3.5159	1.4549	0

\*Value on kilometer

Then by using dijkstra algorithm, can be used with the following steps :

Table 6. Dijkstra algorithm test table

Node Destination	Route	Input									Output					
		X1	X7	X18	X19	Y4	Y7	Y9	X1	X7	X18	X19	Y4	Y7	Y9	
-	-	0	0	0	0	0	0	0	∞	∞	∞	∞	∞	∞	∞	
X1	X1	1	0	0	0	0	0	0	∞	2.967 (X1,X7)	∞	∞	3.1168(X1,Y4)	∞	∞	
X7	X1,X7	1	1	0	0	0	0	0	∞	2.967 (X1,X7)	7.5194(X1,X7,X18)	∞	3.1168(X1,Y4)	5.7629(X1,X7,Y7)	7.1846(X1,X7,Y9)	
Y7	X1,X7,Y7	1	1	0	0	0	1	0	∞	2.967 (X1,X7)	7.5194(X1,X7,X18)	8.4766(X1,X7,Y7,X19)	3.1168(X1,Y4)	5.7629(X1,X7,Y7)	7.1846(X1,X7,Y9)	
X18	X1,X7,X18	1	1	1	0	0	1	0	∞	2.967 (X1,X7)	7.5151(X1,X7,X18)	8.4766(X1,X7,Y7,X19)	3.1168(X1,Y4)	5.7629(X1,X7,Y7)	7.1846(X1,X7,Y9)	
Y4	X1,Y4	1	1	1	0	1	1	0	∞	2.967 (X1,X7)	7.2217(X1,Y4,X18)	8.4766(X1,X7,Y7,X19)	3.1168(X1,Y4)	4.4965(X1,Y4,Y7)	6.6327(X1,Y4,Y9)	
Y9	X1,Y4,Y9	1	1	1	0	1	1	1	∞	2.967 (X1,X7)	7.2217(X1,Y4,X18)	8.4766(X1,X7,Y7,X19)	3.1168(X1,Y4)	4.4965(X1,Y4,Y7)	6.6327(X1,Y4,Y9)	
X19	X1,Y4,X19	1	1	1	0	1	1	1	∞	2.967 (X1,X7)	7.2217(X1,Y4,X18)	8.4766(X1,X7,Y7,X19)	3.1168(X1,Y4)	4.4965(X1,Y4,Y7)	6.6327(X1,Y4,Y9)	

From table Dijkstra algorithm testing for connectivity to the mesh network, can be tested when the node X1 that want to communicate with nodes Y7 the nearest path based algorithm Dijkstra is through node X1 → Y4 → Y7 with the total distance is 4.4965 Km. and if the node X1 want to communicate with nodes on meal x19 based algorithm Dijkstra nearest route that must be passed is passed X1 → X7 → Y7 → x19 node with a total distance is 8.4766 Km. So the nodes X1, X7, X18, x19, Y4, Y7 and Y9 can communicate more efficiently with shorter distance.

## 5. Conclusions

In designing the mesh network maritime There are several steps that need to be done is to analyze the characteristics of signal propagation above sea level beforehand, it aims to determine the losses in the transmission of signals above sea level, losses, it makes one parameter  $n$  exponent is worth 2.5494 - 3.3365 where the value is only valid on the territorial waters of a Tanjung Perak surabaya into Karang Jombang Island area, because it uses high parameter waves in the region. Then the  $n$  exponent is one of the parameters used in calculating

the value of path loss based on factors territory. And then the path loss value obtained is used to calculate the value of received power level at each distance. So we get the value of the coverage area of 4.65 Km. The value of coverage referenced in the design of maritime mesh network. Where the scenarios that have been choosing then the nodes will be interconnected if the node in the coverage area. But for nodes that are not connected to the other node because it is not included in the coverage, then used the algorithm determines Dijkstra glittering mesh network connectivity with the nearby track consideration. example in the scenario node node X1 want to deal with Y9, the route chosen by the algorithm Dijkstra is passed node X1 → Y → Y9 with the total distance is 6,631 Kilometer.

## Acknowledgements

This work was supported in The authors would like to thank their Telecommunication members in Electronic Engginering Polytecnic Institute of Surabaya (EEPIS) for producing some of the results presented in the article.

## References

- Direktur Jenderal SDPPI. 2014."Papararan Narasumber Rakornas Kominfo". <http://web.kominfo.go.id>. Accesed on 7<sup>th</sup> July 2015.
- ITU-R M.2202. 2010. *Maritime Broadband Wireless Mesh Networks*. <https://www.itu.int>. Accesed on 15<sup>th</sup> July 2015.
- ITU, "Attenuation by atmospheric gases," ITU Recommendation P.676-10, ITU, Geneva, Switzerland, 2013.
- J. D. Parsons, *The Mobile Radio Propagation Channel*, Wiley, New York, NY, USA, 2nd edition, 2000.
- Timmins, I.J.; O'Young, S. *Marine communication channel codeling using the Finite-Difference time domain method*. IEEE Trans. Veh. Technol. 2009, 58, 2626–2637.
- Lee. Y,H and Meng. Y,H. 2015. *Key Considerations in the Modeling of Tropical Maritime Microwave Attenuations* (Journal Internasional). Singapore: Nanyang Technological Univesity.
- Lee. Y.H. dkk. 2014. *Near Sea-Surface Mobile Radiowave Propagation at 5 GHz: Measurements an Modeling*. Singapore: Nanyang Technological University.
- Bai. Y, dkk. 2012. *Over-the-Sea Radio Propagation and Integrated Wireless Networking for Ocean Fishery Vessels*, pp 180-190. China: Hainan University.
- Capkun, S. dkk. 2001. *GPS-free Positioning in Mobile ad Hoc Networks*. Swiss: Institute for Computer Communication and Applications.

# Parallel Processing to Improve Performance of e-Learning Server Used Message Passing Interface (MPI) Case Study at SMA Negeri 1 Pekanbaru

Abdul Syukur<sup>a\*</sup> and Evizal Abdul Kadir<sup>b</sup>

<sup>a,b</sup>*Teknik Informatika, Fakultas Teknik, Universitas Islam Riau  
Jl. Kaharuddin Nasution, Marpoyan, Pekanbaru, Riau, Indonesia 28284*

---

## Abstract

Along with the development progress of science, the number of computer resource demand is also increasing. Some fields that require high-end computing is numerical simulation, the problems of science, mathematics and engineering. Thus the computational problem is not a problem with the presence of this cluster that offers services to perform computational processes that exceed the speed of the server computer that stand alone. Cluster is a collection of stand-alone computers that are connected to one another in a computer network used to perform specific computing process in parallel. Cluster basically using the network, but that is characteristic in particular is how this configuration is used to solve the problem. The problem here is how to increase or to balance server workloads e-learning (web server) and the mechanism Message Passing Interface (MPI).

## Keywords

*Cluster; Server e-Learning; Stand Alone; Parallel Processing; MPI*

---

## 1. Introduction

Currently the development of computer technology has been growing rapidly, one of which is a networking technology, and one of the development of network technology is Parallel Processing Computing. Parallel processing is the process of computing work by using a programming language that run in parallel at the same time. In general, parallel computing is necessary to improve the computing speed when compared to the use of computing on a single computer.

Cluster (parallel processing) constructed a dedicated cluster specifically for high-performance computing or High Performance Computing (HPC) and server performance balancing e-learning or Load Balancing Cluster (LBC). To build a cluster (parallel processing) that requires at least two computers connected to a private network. The operating system is selected to create a cluster (parallel processing) is the Linux operating system. Linux is chosen because it is considered as an operating system that is easily configured to meet the infrastructure of a cluster (parallel processing) and open source. Linux cluster must have a mechanism parallel processing to run applications that can be run in parallel. Parallel processing mechanisms used are Message Passing Interface (MPI). Message Passing Interface (MPI) is a programming interface that is used to distribute computing to the vertices of the other in a cluster (parallel processing).

SMA Negeri 1 Pekanbaru is one of 132 high schools in Indonesia Patronage Ministry Directorate of high school to become a school Implementing Model SKM-PBKL-

---

\* Corresponding author. Tel.: +0-000-000-0000 ; fax: +0-000-000-0000 .  
E-mail address: [abdulsyukur@eng.uir.ac.id](mailto:abdulsyukur@eng.uir.ac.id)



PSB where the school-based learning should apply Information and Communication Technology (ICT) in particular e-learning. With the research on parallel processing and cluster computers, is expected to provide solutions to the problems of computing to improve server performance e-learning SMA Negeri 1 Pekanbaru.

## 2. Support Theoretical

### 2.1. Taxonomy Flynn for Computer Architecture

Taxonomy is the most popular computer architecture defined by Michael J. Flynn in 1966, Flynn classification scheme based on the flow of information to the processor. Two streams of information flowing on the processor are instruction and data. The instruction stream is defined as a sequence of instructions processed by the processing unit. The data stream is defined as traffic data exchange between memory and processing unit. According to the classification Flynn, the flow of instructions and data flow can be either singular or plural. Computer architecture according to Flynn can be classified as follows:

- a) SISD : Single Instruction Single Data
- b) MISD : Multiple Instruction Single Data
- c) SIMD : Single Instruction Multiple Data
- d) MIMD : Multiple Instruction Multiple Data

### 2.2. Computer Cluster

Cluster is a set of computers connected and work together as an integrated computer resources to accomplish a goal. A computer cluster consists of at least Message Passing Interface (MPI) and a regulator workload (Job Scheduler). Message Passing Interface (MPI) task for sending data between computers in a parallel system (usually referred to as nodes or host). Job scheduler such as the name would imply duty to receive tasks from the user and to schedule the job on multiple nodes in a parallel system as needed.

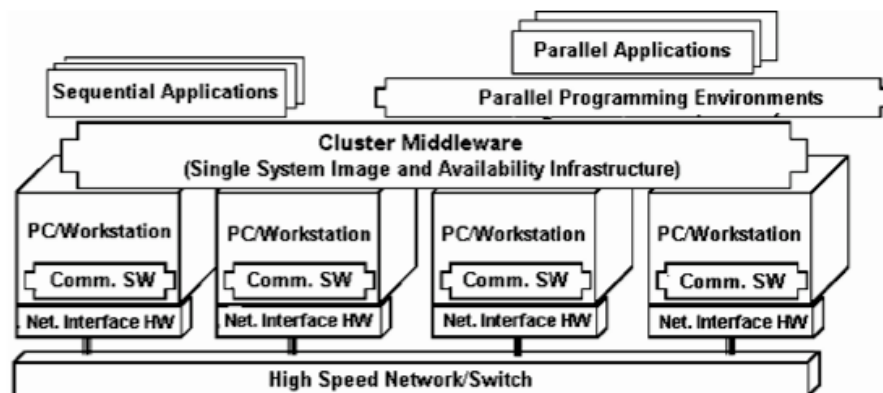

Figure 1. Computer cluster layer.

A system need to build a cluster of four components, namely the two components of hardware and two software components. The first hardware component is a node or computing engines, and the second is a network of interconnected, whereas the first software component is software that can be used by users to develop parallel

applications and the second is the software used to monitor and manage applications running in the cluster.

### 2.3. System Cluster

Clustering in computer science is a combination of computer resources connected to each other and work together at the same time to perform a task or provide a service. Personal Computer (PC) cluster is a computer system that consists of multiple PC (Personal Computer) which is connectable to a network to perform a task or perform computational work together.

The fundamental mode of the cluster itself is divided into four types, namely:

- a) High Performance Computing (HPC) is a type of cluster with high performance achieved with the distribution of tasks or the loads into a set of server computers. High Performance Computing (HPC) is a set of servers that work together at the same time to do something specific task, usually in the form of calculation tasks such as weighty, such as simulating the earth, render animated films, and others.
- b) Load Balancing Cluster (LBC) is a concept for load balancing or workload to multiple server computers, for example divide the workload web server and database server.
- c) High Availability Cluster (HAC) is a type of computer cluster if a server fails serves a particular service, and then the task of the server is automatically thrown to the other server.
- d) Grid Computing (GC) grid computing technology is a way of merging the resources owned many computers connected in a network so as to form a unified computer system with large computational resources.

## 3. Research Methodology

In the methodology of this study it can be concluded that the problems faced is the use of server resources that are not optimal. The methodology can be used to increase a server is to create a Cluster Load Balancing (LBC). With the Load Balancing Cluster (LBC) is expected to address the issue of resource dependency and can improve performance or balance the workload on the server e-learning SMA Negeri 1 Pekanbaru.

### a) Preliminary Study

The initial phase will be done to complete this study is a preliminary study, which is studying and researching the issues to be analyzed. The scope of the issues examined or analyzed should be determined beforehand, because without specifying and defining the boundaries of the problem to be studied, then there is never a solution to these problems.

### b) Literature

In pursuit of research that has been set, it is necessary to learn some of the literature that will be used in this study. Then studied literature were selected for the literature can be determined which will be used in research. Through the study of literature, we can learn the theories with the use of technology parallel processing that can be applied to improve the performance of server e-learning. Its source may include books, national and international journals, and those associated with parallel processing technology and utilization.

### c) Data Collection

To obtain the desired data, the method used in this research is the study of literature or bibliography. Data collected through the study of literature and collect references that had to do with the completion of this study as support research to be conducted.

d) Analysis and System Design

The results in the study of literature, and then performed the analysis phase to determine the need to build a parallel processing both in terms of topology and also the necessary infrastructure. The initial phase will be done is to establish and provide for anything just to make a parallel processing

As for the hardware (hardware) required is three units of computer servers using the Linux operating system Rocks 6.0 (Mamba) and application Message Passing Interface (MPI) as a mechanism that can perform parallel processing to improve performance or balancing the workload of the server computer and use apps ganglia for monitoring processes and computational burden both on each machine computation and computational load in a cluster or all nodes.

a) Implementation

The implementation phase is the last stage of research. This stage prefers the durability and usability of parallel processing in particular to improve performance or balancing the workload of the server computer. At this stage there is a possibility for further development.

b) Results

The results obtained can form an implementation of parallel processing for high-performance computing or High Performance Computing (HPC) and server performance balancing or Load Balancing Cluster (LBC) to be applied to the world of education, government agencies, and companies.

#### **4. Design and Analysis**

This section discusses the analysis and design cluster systems that will be used as a parallel processing infrastructure. Clusters are made using three computers with a computer is used as a head node (Front end) and the two others are used as a computer node. Each node uses the Linux operating system Rocks 6.0 (Mamba).

a) Analysis System

For phase analysis of the problems facing our prior audit the network topology that applied previously, it is to know and help us in designing the network topology using computer cluster (parallel processing) that can later be applied to improve or to balance server performance in e-learning. The results of observations conducted in the field as shows in figure 2, the network topology in SMA Negeri 1 Pekanbaru. Based on the scenario of figure 2 can be explained that every computer user either teacher or student environment of SMA Negeri 1 Pekanbaru who wants to access the e-learning intranet either using Personal Computer (PC) of the labor computer is connected to the switch via a cable or using a laptop connected in Wireless Fidelity (Wi-Fi) using the Access Point (AP) which is attached evenly school environment. Based on figure 2, shows that the computer servers of e-learning in SMA Negeri 1 Pekanbaru that exist today still use the stand-alone server. If at the same time the teacher / student actively accessing e-learning which numbered about 900 people then it will slow down the performance of the e-learning server because the workload is too heavy.

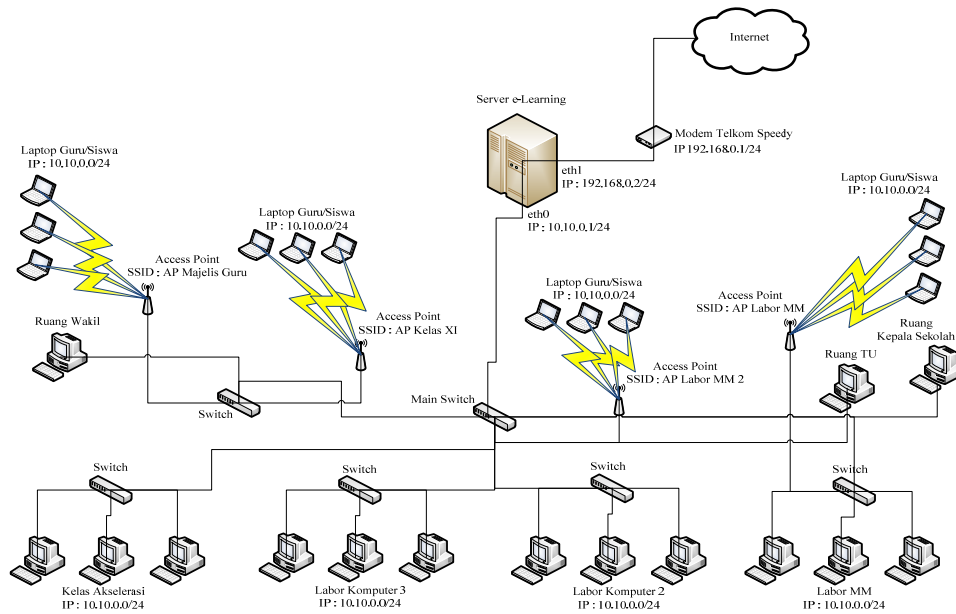

**Figure 2. Network topology at SMA Negeri 1 Pekanbaru before used Parallel Processing.**

#### b) Analysis of Cluster System Requirements

Cluster built in this study is a dedicated cluster for parallel computing. Clusters are built is to homogenize heterogeneous operating systems and using different hardware devices on each computer. In building a dedicated cluster for parallel computing needed some requirements indicated by the following points:

- i. Cluster must have the ability to distribute the computing process of the machine head node (frontend) to machines in other computing.
- ii. Cluster must have a regulatory system data files on each node so as to facilitate centralized system administration.
- iii. Cluster must have a global file system that can be accessed by all the nodes for the purpose of accessing the files.
- iv. Head node (Frontend) must be able to communicate with the machines node without having to make the authentication process.

Cluster must have a system to monitor the processes and computational burden both on each machine computation and computational load in one cluster or all nodes.

#### c) Head Node (Frontend)

Head node (Frontend) is a computer in a cluster that is used to delegate tasks or tasks that will be done by the computer nodes. This computer is also used as a place for users to access the cluster so that users can provide computing tasks into clusters. Head node (Frontend) should be accessible through the network, so that the head node (frontend) requires two Ethernet cards, an Ethernet card connected to the public network and the other is connected to a private network or computer node. Besides being a place of access and delegating tasks to the computer node, the head node (frontend) should also run the services include: Network File System (NFS), Network Information System (NIS), Dynamic Host Configuration Protocol (DHCP), Hypertext Transfer Protocol (HTTP), Secure Shell Host (SSH). The services required by the head node (frontend) to integrate the nodes in the cluster. Machines used as a head node (frontend) should have a higher specification than the machines that are used as a computer node. That is because the machine head node computers greater than the machine computer node for the machine head node (frontend) must be running the services which are not run by the computer nodes.

d) Computer Node

Computer node is a computer worker who received the task of head node (frontend) and process the task. This computer cannot be accessed over the network because it is connected to a private network. The computer that functioned as a computer node can only be accessed by a head node (frontend) to perform the computing process. Configuration files related to user administration systems such as password, group, and etcetera shadow is located centrally in the head node (frontend). The mechanism of centralized configuration is done using the Network Information System (NIS). NIS enables computers computer node will have a uniform system users with the computer system created on the head node (frontend). Use of the Network Information System (NIS) will certainly ease the system administrator to perform addition or removal of users in a cluster system.

e) Network Topology Design

Cluster network that will be created using standard design outline of rocks cluster that will ultimately result in the expected performance at first. In this study, the cluster that was built in the laboratory SMA Negeri 1 Pekanbaru using two units of the server computer, the computer unit is used as a head node (frontend) and one unit is used as a computer node computer-0-0. To improve performance or to balance server performance e-learning, the total amount of Central Processing Unit (CPU) in the cluster there are three units of Personal Computer (PC). It is intended that the resulting performance is able to provide better results again. The following physical network topology and logical topology created in this study.

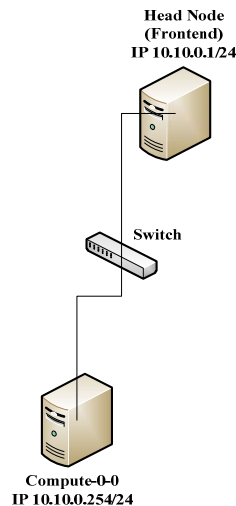

Figure 3. Physical network topology of computer Cluster

Explanation Network Topology Cluster System:

- In the figure 3 topology, there is one head node computer unit (frontend) or master and one computer unit computer node or a slave.
- Computer head node (frontend) serves as the main server in serving computer node to perform parallel processing to improve performance or to balance server e-learning.
- On the head node computer (frontend) providing services to the IP address automatically computer nodes. Service will function after the IP address to configure Dynamic Host Configuration Protocol (DHCP) Server.

d) Network topology design used *Load Balance Cluster (LBC)* method.

In the method of Load Balance Cluster (LBC) concept for load balancing or workload to multiple server computers, for example divide the workload web server and database server. The workload of a network spread across the nodes of this is to improve performance in network computing.

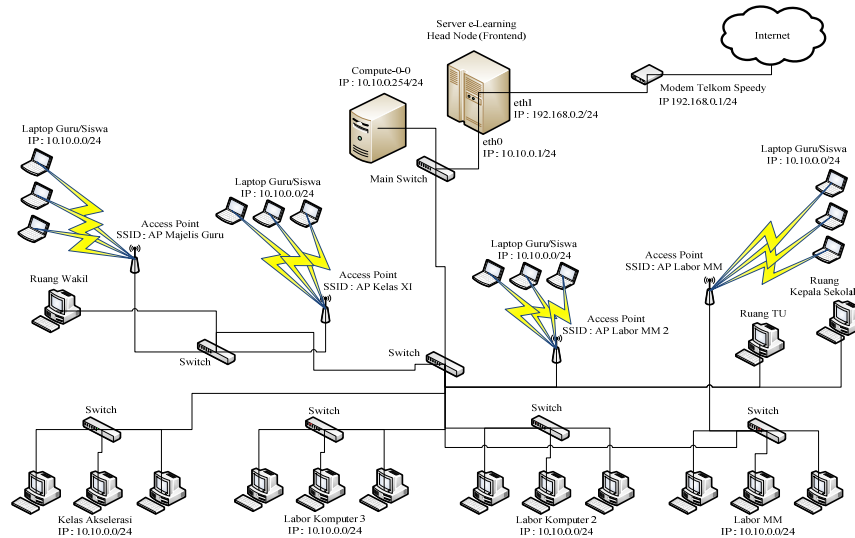

**Figure 4. Computer network topology in Cluster (Parallel Processing) at SMA Negeri 1 Pekanbaru.**

Based on the figure 4, server computer e-learning are connected in parallel itself of two units of the server computer, wherein the computer units serve as the head node (frontend) and one computer unit used as a computer node, the computer-0-0. Addressing the entire IP address connected in the network will obtain IP address automatically using the IP address of class A with a range 10.10.0.1 - 10.10.0.254.

Every computer user either teacher or student in environment that will access the e-learning intranet either using Personal Computer (PC) of the labor computer is connected to the switch via a cable or using a laptop connected wirelessly (Wi-Fi) using the Access Point (AP) attached evenly school environment. By using the Load Balance Cluster (LBC) is applied based on network topology above would be expected in the future if the teacher or student active simultaneously will access the e-learning will not slow down the performance of the server e-learning for both server computers that share the workload in servicing computer client.

## 5. Implementation

In order to develop this cluster, several stages to be done both in terms of configuration and installation of software and support package that will be useful for parallel processing. Here are the stages are performed in this study.

- To determine the hardware requirements (hardware) and software requirements (software).
- Installation of linux rocks 6.0 (mamba) on the head node computer (frontend).
- Administration head node (frontend).
- Installation of computer nodes.
- Testing the cluster system (parallel processing).
- Testing with the computer nodes.
- Testing the client computer that will access e-learning.
- Testing using a single client computer that access e-learning.
- The test uses two client computers that accesses e-learning.

- j) The test uses three client computers that accesses e-learning.
- k) Allocation of memory.
- l) Conclusion testing.

#### A. Hardware Requirement

Here are the specifications of the computer head node (frontend) and computer nodes used in this study.

##### 1) Spesifikasi Komputer *Head node (Frontend)*

Berikut adalah spesifikasi komputer head node (frontend).

- a) CPU Speed : 2.40 GHz
- b) CPU Model : Intel(R) Core(TM) i5 2430M CPU
- c) HDD Device : SATA, 500 GB
- d) USB Controller : NEC Corporation uPD720200 USB 3.0
- e) IDE Device : DVD-RW Multi
- f) RAM : 4 GB
- g) Audio Device : Intel Corporation 6 Series/C200
- h) Ethernet Controller : Realtek Semiconductor Co., Ltd. RTL8101E
- i) Motherboard : Dell

##### 2) Specification of Computer node (0-0)

Berikut adalah spesifikasi komputer Computer node (0-0).

- a) CPU Speed : 2.20 GHz
- b) CPU Model : Intel(R) Pentium(R) Dual Core CPU T4400
- c) HDD Device : SATA, 320 GB
- d) USB Controller : Intel Corporation 82801I USB 2.0
- e) IDE Device : DVD-RW Multi
- f) RAM : 2 GB
- g) Audio Device : Intel Corporation 82801I
- h) Ethernet Controller: Realtek Semiconductor Co., Ltd. RTL8101E
- i) Motherboard : HP

#### B. Software Requirement

Here is the need of software (software) used in this study.

- a) Operation System Linux Rocks 6.0 (Mamba)
- b) Message Passing Interface (MPI)
- c) Ganglia
- d) Apache web server
- e) MySQL server

#### C. Cluster Testing System (*Parallel Processing*)

By default if everything configured the cluster we got it right on the head node computer (frontend) then we can use the application to monitor system ganglia cluster. The following graphic display is done in the study where the following image display is still using a computer stand alone server or has not happened the processes cluster (parallel processing).

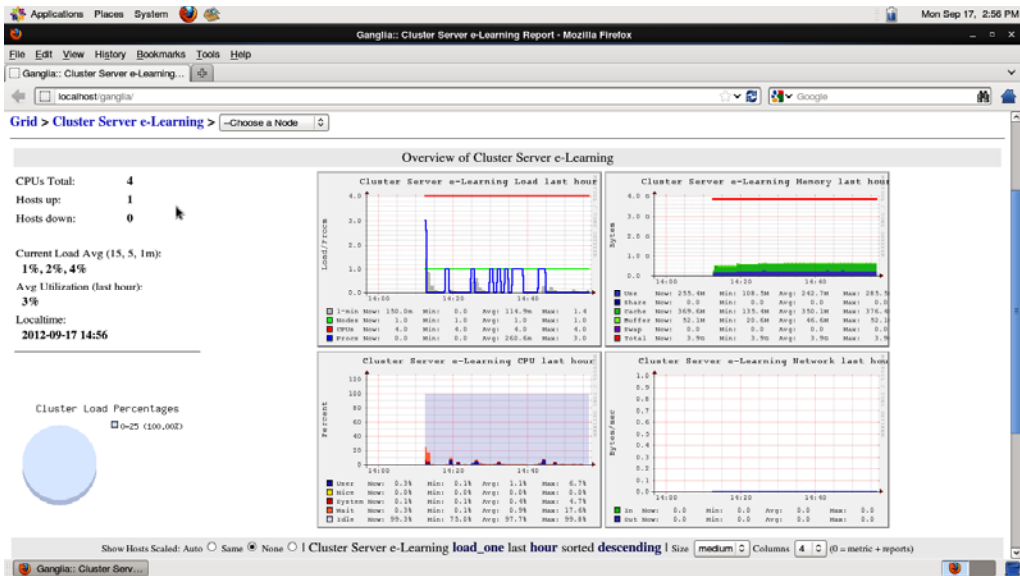

Figure 5. Monitoring System Server Stand Alone at Ganglia

Based on the description of Figure 5 shows a graphic display of a computer processor head node (frontend) that stand alone, meaning that not happened a parallel processing between the computer head node (frontend) to computer nodes. Total processor contained on the caption above, namely four (Quad Core). Host up to one unit that meaning that only the nodes that are running.

#### D. Cluster System (Parallel Processing)

The following graphic display is done in the study where the following image display has been a parallel processing between the computer head node (frontend) to the computer nodes (computer-0-0).

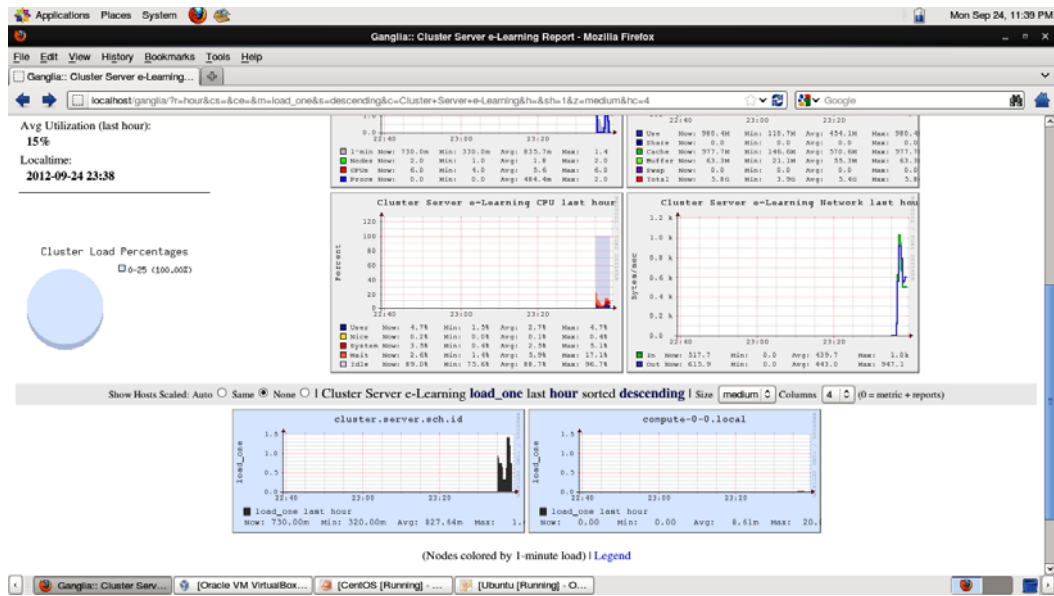

Figure 6. Cluster Monitoring System at Ganglia Used 2 Node



Based on information from the graph Figure 6 looks the two nodes shown on application monitoring (ganglia) that cluster.server.sch.id and computer-0-0.local, meaning between the computer head node (frontend) and computer nodes (computer-0-0) are connected in parallel (cluster). The information that can be seen from the above picture by default will be visible all the resources that exist in the system, based on what tab shows the metric system in monitoring, can select a category. For more detail see Cluster status we can choose the Top Cluster shows information process from each node in the cluster system. Total processor contained on the caption above those six pieces, where the head node computer (frontend) is using a Quad Core processor and computer nodes (computer-0-0) using processor Dual Core. Host up two that meaning there are two nodes that are running.

#### E. Testing Used Computer Note

Once everything is installed properly it will display the image below, enter login "com0" with password "com0" on computer-0-0. Computer nodes will automatically log them centrally on the head node computer (frontend). Figure 7 shows of computer-0-0 and computer-0-1 were performed in this study.

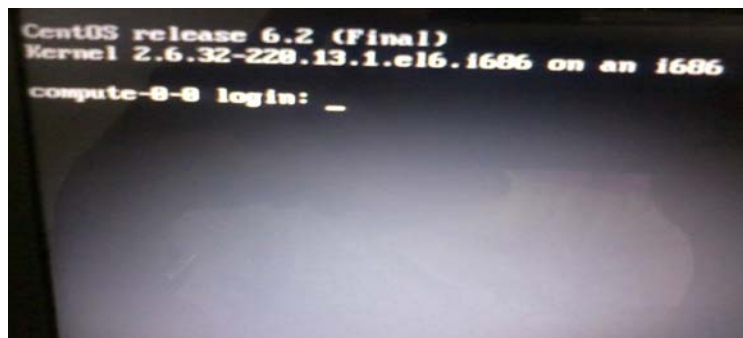

Figure 7. Login display of Computer-0-0

After all installed properly to ensure computer head node (frontend) and the computer nodes are integrated correctly, then we will select the tab "Physical View" in the monitoring system in the ganglia so that the display appears as below.

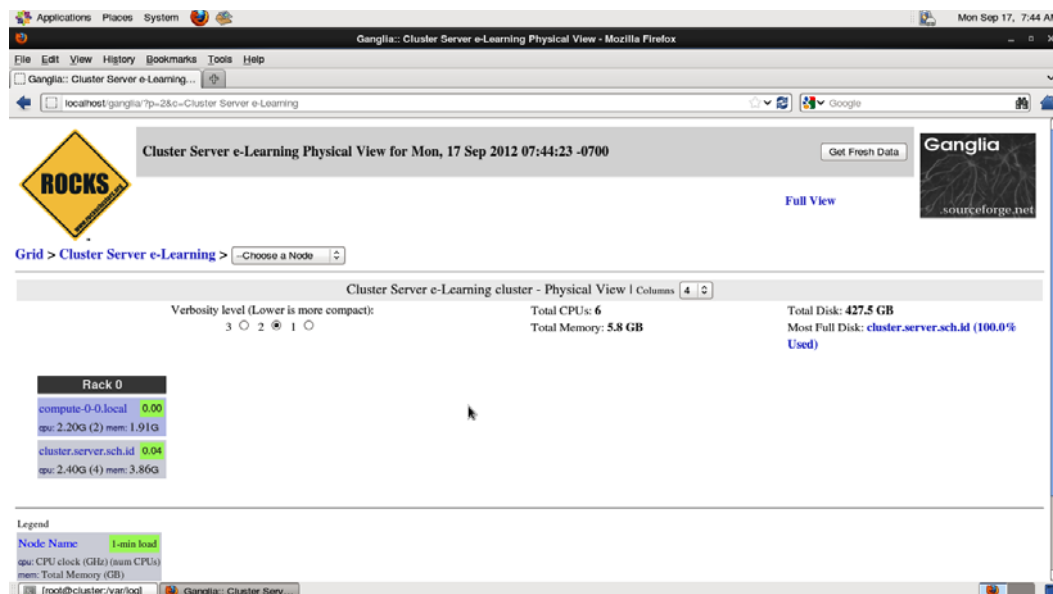

Figure 8. Display of Physical View at Ganglia

Based on information shows in figure 8 the head node computer (frontend) and the computer nodes are integrated properly. In other information that can be seen from the description of the image above the number of processors, processor speed, total memory, total hard drive.

#### F. Testing with *Client Computer Accessing e-Learning*

The next stage is to test from a client computer to access e-learning. In this experiment will be accessible using a web browser Mozilla Firefox, from the server side using Apache as the web server and MySQL as the database server of its.



Figure 9. One of user login in e-Learning

Based on information from the figure 9 shows the user Abdul Syukur was login at page e-learning on the computer head node (frontend).

#### G. Testing Used Two Unit of Client Computer *Client* to Access e-Learning

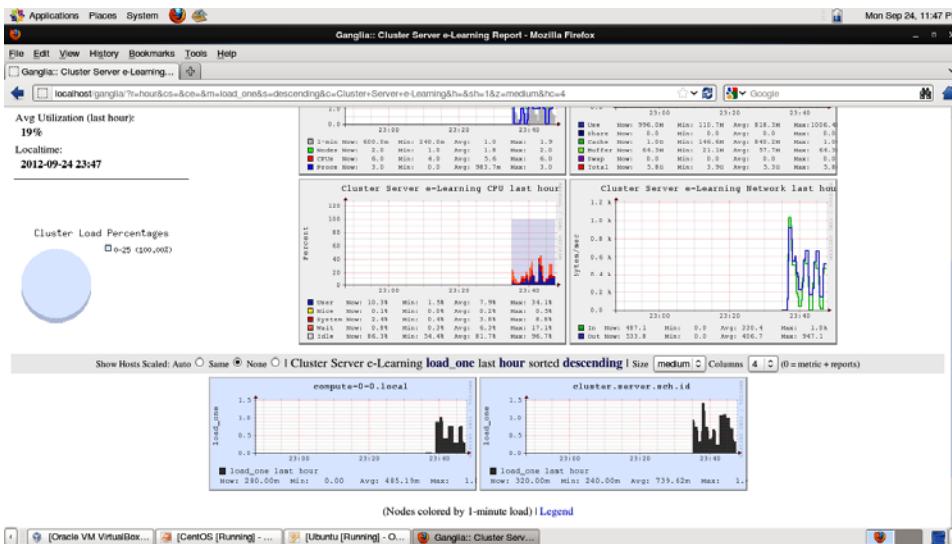

Figure 10. Cluster monitoring system used 2 Unit of client computer to access e-Learning

Based on information from the computer graphic image shows a cluster in figure 10 (parallel processing) where the condition of the computer graphics head node (frontend), which provides e-learning web server being accessed using two units of the client computer. At the time of the client computer to access e-learning server looks graph between cluster.server.sch.id and computer-0-0.local traffic will be increase and balance, reflecting the diversity of traffic that is displayed using three units of the client computer than using two computers client and the client computer unit is accessing e-learning.

#### H. Memory Allocation

In this case the memory usage will certainly be indispensable in doing parallel processing. Every memory usage will assist in the process of balancing cluster to improve server performance or e-learning. Table 1 is shows the result of the conclusion of use of available memory.

**Table 1. Memory used**

<i>Node Cluster</i>	<i>1 Node</i>	<i>2 Node</i>	<i>Total</i>
<i>Ukuran Memori</i>	<i>3.86 GB</i>	<i>1.91 GB</i>	<i>5.8 GB</i>

## 6. Conclusion

The conclusions in this test are:

1. The entire cluster has been able to run as expected.
2. The client computer successfully accesses the e-learning web server that no computer head node (frontend).
3. From the results of testing the use of a single node processor (Cluster Load Percentages) is 100% and the use of two nodes using a processor (Cluster Load Percentages) is 50%. To use cluster.server.sch.id processor 0-25 (50%) and for the use of the processor computer-0-0.local 25-50 (50%).

## References

- Fatullah Fani, Mutiara MQN A. Benny, Yulianto Chandra, (2004) "Analisa Kinerja *Cluster Linux* Dengan Pustaka *MPICH* Terhadap Perkalian Matriks", KOMMIT 2004, Jakarta.
- Harsono Nonot, Sukaridhoto Sritrusta, Subhan Ahmad, Sudarsono Amang, (2006) "Model *Distributed Data Processing* Berbasis *Open Source* Untuk Pengolahan Data Kependudukan Dalam Rangka Implementasi *e-Gov* Indonesia", Prosiding Konferensi Nasional, Bandung.
- Hidayat Syarif, (2006) "Pemrosesan Paralel Menggunakan Komputer Heterogen", SNATI 2006, Yogyakarta.
- Kurniawan Agus, Arsyad Sagi, (2010) "Desain dan Implementasi Komputasi Paralel Pada *Excel*", SNATI 2010, Yogyakarta.
- Lauwali Tomiputra, Kartawidjaja A. Maria, (2008) "Komputasi Paralel Menggunakan *Parallel Virtual Machine* Untuk Peningkatan Kinerja Komputasi", Jurnal Elektro, Jakarta.
- Liswandini Intan, Irawan Budhi, Irzama, "Studi Komparatif Antara *Parallel Virtual Machine* (PVM) dan *Message Passing Interface* (MPI) Dengan Memanfaatkan *Local Area Network* (LAN)", Jurnal, Bandung.
- Prianto Bayu, (2008) "Cluster Komputer Sebagai Pengganti Super Komputer Tunggal Untuk Pemodelan Kimia Komputasi" Jurnal Berita Dirgantara.
- Siregar Simon, Ismail, Hendri Rio, (2010) "Pengukuran Kecepatan Proses Pada *High Performance Computing* (HPC) *Cluster Server*", Jurnal, Bandung.
- Suwarningsih Wiwin, Nuryani, Arisal Andria, Wirahman Taufik, Masthurah Nurhayati, (2009) "Membangun *Cluster* Dengan Menggunakan *IGOS* Dwi Warna", SNATI 2009, Yogyakarta.
- Widyatmoko Amri, Halimurahman, (2006) "Manajemen *Linux Cluster* Menggunakan *Rocks 4.1* dan Integrasi Model *Atmosfer WRF*", Prosiding Semiloka Teknologi Simulasi dan Komputasi Serta Aplikasi, Bandung.

---

**Designing an Automated Control of  
a Portable Hydroponic Plantation Facility based on  
Fuzzy Logic Algorithm.**

Wahidin Wahab<sup>a</sup> and Andhika Kumara Djafri<sup>b\*</sup>

<sup>ab</sup>*Department of Electrical Engineering, Universitas Indonesia  
Kampus UI Pondok Cina Depok, Indonesia 16424*

---

**Abstract**

The paper discusses the design of an apparatus for hydroponic plants to grow effectively in a limited growth area, using a plastic square tank with a size of 60 cm by 80 cm, which is filled using a pump with water and the growth media, so that it can be easily move from one place to another, and moreover can be stacked on top of another. The required acidity and nutrient, as well as the intensity of sunlight, are controlled using a microcomputer, based on the pre-set values to the standard requirements for specific vegetables. These values are set preliminary in to the microcomputer and use as references for the control algorithms. To release the system from the non-linearity conditions, the fuzzy logic control algorithm is applied to each of the control loop such that the growth environment required for the vegetables can be achieved. A stirrer is used to speed-up the mixing time to reach homogeneous condition. The Takagi-Sugeno type Fuzzy Logic Controller was used, with only three membership functions at the input and the inference results are then weighted averaged at the output. The results shows that the apparatus works well under closed loop control, although there is still a small problem due to slow response and the insentitivity nature of the pH sensor that should be clean very often for better results.

(Abstract should be approximately 200-250 words in length)

**Keywords**

portable growth media, fuzzy logic Control, plant nutrition, pH sensor, acidity

---

**1. Introduction**

The current trend on hydroponics technology in farming is heading towards a promising growth with applications mainly in the green vegetable industry[1]. Several Hydroponic methods can be applied according to resource availabilities and needs, and nowadays it is not only done by farmers, but also by hobbyist in regular households [2][3]. Although the technology is fairly easy to be implemented, it is occasionally found difficult to get good results due to the improper handling to maintain the constant nutrition value, growth media acidity, as well as lighting, which are important aspects in the farming [4]. For this reason, a technology to support the maintenance of hydroponic plants automatically, is developed so that farmers can achieve the highest quality with

---

\* Wahidin Wahab Tel.+62-811-977-779, fax: +6221-727-0078.  
E-mail address: wahidin.wahab@ui.ac.id

minimum effort. The system aims to broaden the scope of farmers so hydroponics can be done by anyone, anywhere and anytime. In this paper, an automation system that can simplify hydroponic farming in monitoring, maintaining, and optimizing the growth of hydroponic plants is designed. The system is based on microcontrollers, sensors, and actuators that adjusts pH value, nutrition concentration, and lighting with user friendly operation and affordable price. Each unit is also made portable, can be arranged easily into stainless steel racks which are staggered in a large room.

## 2. The System Design

In this research, we use the Flood & Drain method, which is a hydroponic growing system where plants get the water, nutrition, and oxygen through a reservoir that is pumped in to the media in the grow tray. In a certain time, the water together with the nutrition will be drained back to the reservoir through an overflow channel. And after a certain predetermined time passed the the solution liquid is pumped back in to the grow tray, such that the roots of the vegetables will not be dried up, which may cause it to die of drought. The cycles of flood and drain is repeated during the grow period until the vegetables are harvested. The flood and drain period can be adjusted using a timer eliminating the risk of plant dehydration or overwatered. Fig. 1 shows the detailed diagram of the Flood & Drain grow tank. [5][6].

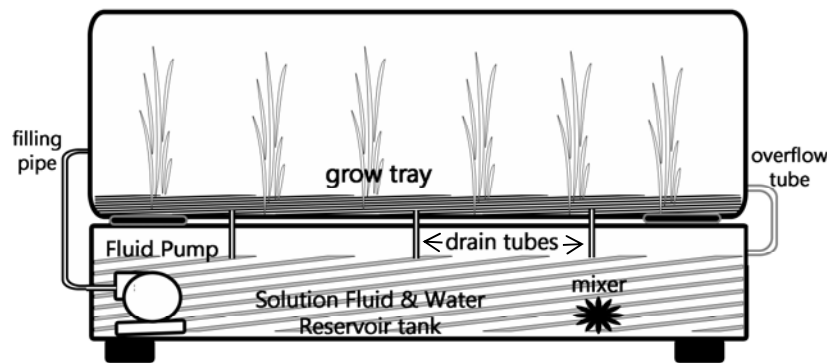

Figure 1. The Ebb & Flow system for portable hydroponic.

The height of the roof is in the range of 30 to 50 cm, depending on the type of vegetables to be grown, and the roof is designed to be detachable, to ease the farmer when harvesting.

The system involves the control of pH, nutrition, and lighting to support the plant growth effectively. All facilities are provided and controlled by using an Arduino-Uno single-board microcontroller, which is reasonably cheap and has the capability to support all necessary functions in the system. The system controls water flow using a water pump that runs under the control of a timer, air concentration in the water reservoir using an aerator, a stirring motor to mix the pH regulating solution and nutrition in the reservoir. The system is equipped with an LCD display and Keypad for users to input a required set point for the pH level, while other aspects are controlled automatically in a certain amount of time using the microcontroller internal timer. Keypad, LCD Display, and pH sensors are connected directly with the microcontroller while the micro gear pumps are powered by an external 12V DC source and the aerator is powered by an external 220V AC power source.

### 2.1. The User Interface

The user interfaces consist of a numeric keypad and an LCD Alphanumeric Display, which are connected to the microcontroller via I2C serial interface lines with

analog pin A4 and A5 connected, as shown in figure 2 below. The keypad is used to set the necessary data for setpoints, while the LCD is used to display the necessary information to the user.

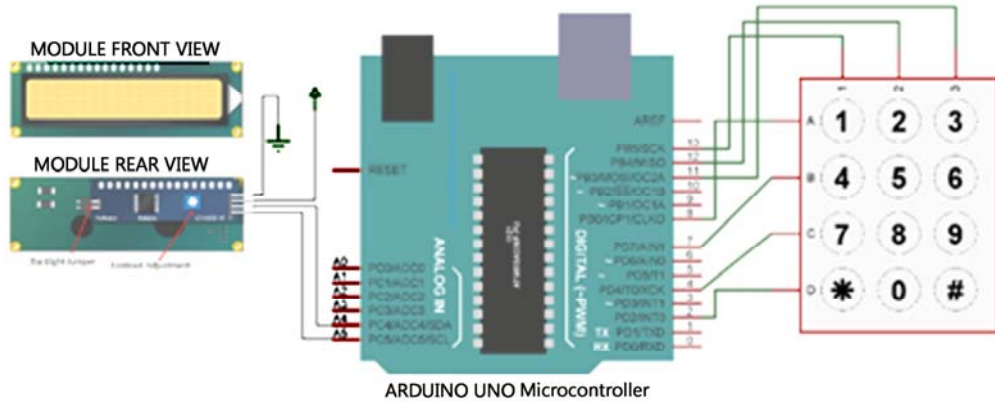

Figure 2. the user interface electronics

## 2.2. The controller

The acidity of the liquid and its nutrition content, are infact the most important to be managed carefully but both are also the most difficult to be controlled. This is due to the non-linear characteristics of the titration process of controlling the pH values of the liquid solution, and the non-linear characteristics of the nutrition sensor. And it is due to the same reason, the Fuzzy Logic controllers are used in both cases.

The data of pH of the growth liquid is acquired by using a pH sensor, and the nutrition content is read using a conductivity sensor as the nearest indicator to be used for th nutrition content. The closed loop Fuzzy logic control block diagram for pH control is shown in figure 3 below. The pH value is read using a pH probe, and sent to the micro controller, and then compared to the setpoint, the error and change of error are calculated as :

$$\text{CurrentError} = \text{pH set} - \text{actual pH}, \quad (1)$$

$$\text{ChangeOfError} = \text{CurrentError} - \text{pastError} \quad (2)$$

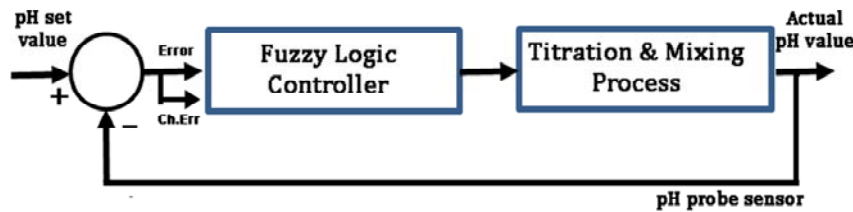

Figure 3 the Fuzzy logic Controller set-up

These two information is then fed in to the Fuzzy logic controller, to be fuzzified, using the membership function defined in the FLC for the Error and the Change of Error as shown in figure 4 below, each contained only three triangular shaped membership functions. Using the Takagi-Sugeno Type Inferences, the rule base is defined in the form of IF- THEN rule as follows:

$$\text{IF Error IS } A \text{ AND ChangeOfError IS } B \text{ THEN Out} = ax + b$$

The  $A$  is one of the three conditions for error, ie., *Acidic*, *Normal* or *Alkalic*. While  $B$  is one of the the other three conditions for the *changeOfError*, ie., *Low*, *Average*, or *High*. The function  $out = a x + b$ , are straight line approximation of the titration curve, which can be divided into 7(seven) segments of straight lines, but be aware that the value of the output is zero, indicate the pH has reached the value of 7, ie. reach the normal condition,

while a positive value indicates alkalic condition, and while a negative value indicate the acidic condition.

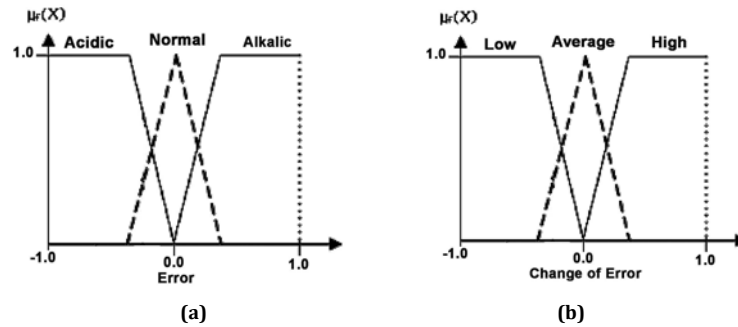

Figure 4. Triangular shape membership function, (a).for Error, and (b) for ChangeofError

At the defuzzification stage, the output of the inference engine, will be averaged, using the same weight of =1.0 which means both acidic and alkalic conditions are equally important for the system. When the defuzzification output indicate “alkalic condition, and the pump which releases the Phosphoric Acid (H3PO4) 10% solution should be set to “ON”, and when it indicates the acidic condition, and the pump which releases Sodium Hydroxide (NaOH) 10% solution should be set to “ON”. And the absolute values of the defuzzification will determine the length of the “Pump ON” condition. The sensor reads the pH in 20ms interval and the LCD display is updated in 800ms interval [8]. One of the recording of the response of the pH value when changed from 10.5 down to 5.75 is shown in figure 5, it is seen that the settling time is around 175 secods and the time constant is 30seconds. Which is still very resonably fast for this type of system.

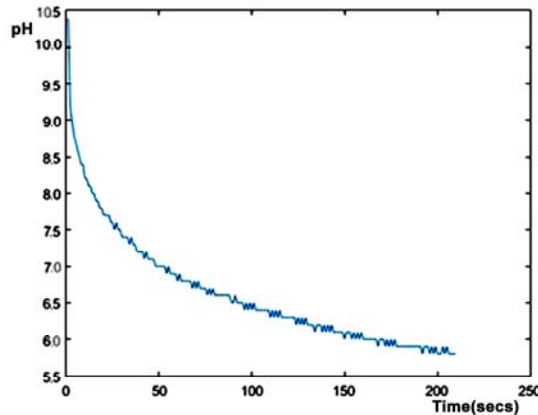

Figure 5. the control of pH to reach 5.75

### 2.3. The control of Nutrition.

The closed loop Fuzzy logic control block diagram for nutrition control is the same shown in figure 3 above. The nutrition value is read using a conductivity probe, and sent to the micro controller, and then compared to the setpoint, the error and change of error are calculated as :

$$\text{CurrentError} = \text{pH set} - \text{actual pH}, \quad (3)$$

$$\text{ChangeOfError} = \text{CurrentError} - \text{pastError} \quad (4)$$

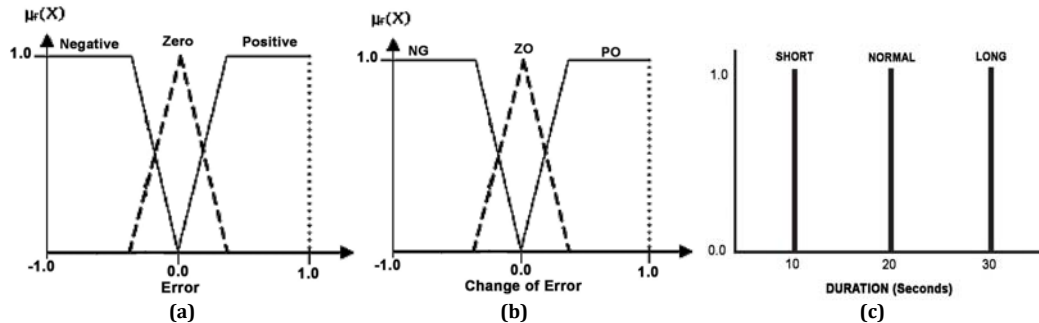

Figure 7. The membership functions, (a) at input Error, (b) at Change of Error, (c) at output

The membership function at the input stage is shown in figure 6., using triangular shape membership function, and the output is using three singleton membership functions. Using the Takagi-Sugeno Type Inferences, the rule base is defined in the form of IF- THEN rule as follows:

**IF Error IS A AND ChangeOfError IS B THEN C**

The *A* is one of the three conditions of *error*, ie., *Negative, Zero and Positive*. While *B* is one of the the other three conditions of the *changeOfError*, ie., *Negative, Zero and Positive*, and the output is the duration of pumping in *Short, Normal, or Long*.

At the defuzzification stage the outputs are averaged by using the same weight equal to 1.0, and the value is used as the time duration to activate the nutrition solution pumping.

#### 2.4. The control of Lighting.

In order to let the hydroponic grow tanks be placed indoors, the it is necessary to provide appropriate lighting to replace the sun-light. According to Resh(1987) and Djaffri(2016) the best color spectrum during the vegetation grows, in general is as follows,

- During Vegetative Period : the blue color spectrum for10 days.
- During The generative Period : the red color spectrum for10 days.
- During the Period of flowering : the purple color spectrum for10 days.

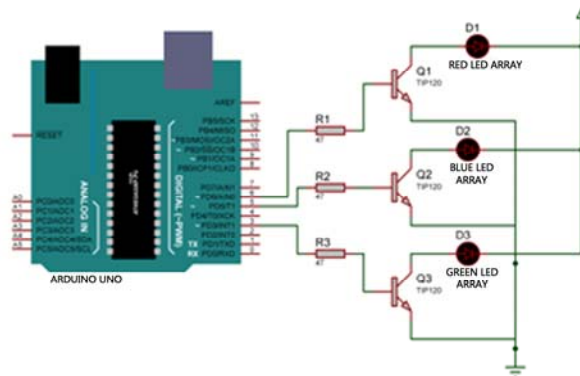

Figure 8. the driver electronics for the RGB Stripes to the microcontroller.

In the hydroponic system, the lighting uses the combination of red-green-blue(RGB) LED Stripes, and then it is programmed in the microcontroller to turn on a switch for each colour-stripe in every 30(thirty) days period, so that RGB LED Strip can change the color spectrum every 10 days with stages of change red -> blue -> purple. The purple colour is the results of having the red and the blue colours together and the green color is not used, can be ignored. The driver electronic for th RGB Led stripes to



the microprocessor is shown in figure 8. above. The sequence of switching on and off is given in the table1.

Switch	0-10	10-20	20-30	30-40	40-50	50-60	...
Red Light	OFF	ON	ON	OFF	ON	ON	
Blue Light	ON	OFF	ON	ON	OFF	ON	
Green Light	OFF	OFF	OFF	OFF	OFF	OFF	
Results:	BLUE	RED	PURPLE	BLUE	RED	PURPLE	

### 2.5. The Flood and Drain Sequence.

The Flood and Drain of the water solution in to the grow tank is arranged by only the on/off period of the pump using a timer generated inside the microcontroller. The power source of the pump is a 12V DC connected through a relay, driven by a series transistor to be controlled by the low powered signal from the microcontroller. The period and the length of pumping is predetermined by the operator, by keying the time period in to the system using the keypad provided.

## 3. Conclusions

In this paper, Automation System for Hydroponic Plantation Based on Flood and Drain Method has been designed and built. The system shows promising automated control of the aspects necessary in hydroponics farming using the method by having most those aspect of pH, nutrition, lighting, and water flow under good controlled, providing the simplification hydroponics farming process. We had tried to apply the Fuzzy logic control to manage two of those important parameter for vegetable growing will a success. There is still yet many room for improvements in the system such as using Neural Network or others algorithms in closed loop control of other aspects beside the pH, which may be developed in the future.

## References

- PRNewswire. (2014) [Online].: <http://www.prnewswire.com/news-releases/growth-in-the-hydroponics-food-industry-set-to-outpace-global-markets-by-80-241264701.html>
- Karsono, Sudibyo, et al. (2002). *Hidroponik Skala Rumah Tangga*. Jakarta : Agro Media Pustaka
- Sutioso, Ir. Yos. (2004). *Hidroponik Ala Yos*. Jakarta : Penebar Swadaya
- (2016) SA Horticulture [Online]. Available: <http://sahorticulture.co.za/six-hydroponic-systems/>
- Resh, Howard M. (1987). *From Hydroponic Food Production*. Woodbridge Press
- Kleitz, William. (1996). *Digital Electronics A Practical Approach*. Fourth Edition. New Jersey : Prentice-Hall International, Inc.
- Bentley, John P. (1995). *Principles of Measurement System*. Third Edition. Singapore : Longman Scientific & Technical
- Mettler T., (09/2009), Basic of Titration, Mettler-Toledo AG, Analytical, CH-8606 Schwerzenbach, Switzerland.
- METTLER T., (2007), "A Guide to pH Measurement – the theory and practice of laboratory pH applications", Mettler-Toledo AG, Analytical, CH-8606 Schwerzenbach, Switzerland.
- Djaffri, Andhika Kumara (2016), thesis, Departement of Electrical Engineering, Universitas Indonesia, Kampus UI Depok, 16424, Indonesia, (in Indonesian).

# On the Performance of Wireless ECG Monitoring System: Case of Off-Body Communications

Basari <sup>a\*</sup>, M. Anugrah Agung <sup>a</sup>, Fitri Yuli Zulkifli <sup>a</sup>, Eko Tjipto Rahardjo <sup>a</sup>

<sup>a</sup>*Department of Electrical Engineering, Faculty of Engineering, Universitas Indonesia, Kampus UI Depok, Depok City, West Java, Indonesia 16424*

---

## Abstract

World Health Organization (WHO) reported that heart disease, stroke, lower respiratory infections and chronic obstructive lung disease have remained the top major killers in the world during the past decade. In Indonesia, it covers 37% or about 1.8 millions mortality cases. Hence, human vital sign monitoring such as electrocardiograph (ECG) monitoring system is very essential for mitigating and preventing people fail to be handled a proper assistance from healthcare physicians. In this paper, we propose a real time ECG monitoring system, which the ECG data is able to be checked wirelessly at specified device directly without any server for data pooling (centralized database). ECG QRS wave and arrhythmia detection are important features for ECG monitoring system. Up to now, there are several studies ECG wave detection, however, they are mainly focus on internet of things - based telemedicine system for data transfer. In this case, real time monitoring system could be disrupted by a pooling time and packet loss due to its IP-based connection. Hence, in this study, we propose a wireless ECG monitoring system with direct point to point communication at 2.4 GHz by using 3-lead acquisition system on single channel wireless ECG device. The system is developed based on AD8232 chip for acquisition, NRF24101 wireless link platform for data transfer and Arduino microcontroller for ECG data processing. In order to evaluate the performance of wireless ECG system, we use wearable textile antennas (as Tx and Rx antenna), on which are attached the human body and experimentally tested in indoor environment, representing an off-body communication. The results show that the developed system is able to transfer and display real time ECG signals up to approximately 15m of obstruction environment, which the measurement is conducted in a sitting position of volunteers. We have also validated the obtained ECG data, comparing to the data taken from the healthcare clinic equipment. Moreover, according to QRS wave analysis, our ECG signals have reasonable RR, PR, QRS and ST wave interval comparing to the standard ECG signals.

## Keywords

Electrocardiograph; off-body communications; real time monitoring system; textile antenna; wireless communications

---

## 1. Introduction

World Health Organization (WHO) has reported that heart disease, stroke, lower respiratory infections and chronic obstructive lung disease have remained the top major killers in the world during the past decade. The hearth disease contributed about 48.6% or 7.4 millions of death in the world, where in Indonesia, it covers 37% or about 1.8

---

\* Corresponding author. Tel.: +62-21-7270078; fax: +62-21-7270077.  
E-mail address: basyarie@eng.ui.ac.id

millions mortality cases. For the sake of this case, human vital sign monitoring such as electrocardiograph (ECG) monitoring system is very essential for mitigating and preventing people fail to be handled a proper assistance from healthcare physicians. However, existing ECG devices in Indonesia mostly are situated only in big hospitals. The patient with heart attack will have to come to hospital to check the condition. Due to the lack of fast transportation system in Indonesia, it leads to inefficient time and money. Therefore, it is very important to develop wireless ECG devices. By this device, patient is able to check the heart condition anytime and anywhere easier with affordable spending money. The special condition such as heart attack people also can be accommodated by this wireless ECG system.

Some current researches on ECG have been developed such as in Android-based by Jing et al., 2009, which is able to detect R peak to calculate the beat per minute (bpm). This is supposed to be capable of detecting sinus bradycardia, ventricular flutter, and left bundle branch block. A mobile ECG is proposed by Kailanto et al., 2008, which combine the Android-application with a server to enable storage and web transmission the ECG data. This mobile system has feature of QRS and arrhythmia detection. Kapua et al., 2010, developed ECG system for telemedicine applications by building a web based system to monitor the patient. There are also some on-going researches for trying a real time ECG signal processing (Bsoul et al., 2011 and Faezipour et al., 2010). In fact, however, the input of ECG data is taken from database directories from some available standard websites, such as MIT and BIH database. Our research focuses on design of a wireless ECG system by using 2.4 GHz of wearable antennas both in transmitting and receiving ECG data wirelessly. This point to point system uses three-lead ECG acquisition technique on a single channel ECG Analog Front End (AFE) AD8232 platform.

In this paper, we discuss some experimental results on wireless ECG system in the case of off-body communication link. The measurement is conducted in indoor room with several distance ranges. First, a proposed wireless ECG system is introduced before we show some experimental scenarios to be conducted for off-body link. Then, the performance results are analyzed by comparing to the standard results that have been conducted in clinic healthcare. Last, we conclude some important points related to the experiment results.

## **2. Proposed Wireless ECG System**

Our research is aimed to design a wireless ECG monitoring system with direct point to point communication at 2.4 GHz by using 3-lead acquisition system on single channel wireless ECG device (Agung & Basari, 2016). The proposed system is developed based on AD8232 chip for acquisition, NRF24101 wireless link platform for data transfer and Arduino microcontroller for ECG data processing. In order to evaluate the performance of wireless ECG system, we use wearable textile antennas (as Tx and Rx antenna), on which are attached the human body and experimentally tested in indoor environment, representing an off-body communication.

The transmitter consists of a microcontroller, AD8232 front end and on-body attached antenna. The antenna size is 5 cm × 2 cm that fabricated on textile substrate, which is operated at 2.45 GHz. AD8232 chip is used to acquire the ECG signal, filtering high frequency and low frequency component from signal and provide 100 V/V of gain. Microcontroller will convert analog raw data from AD8232 chip to digital data. ECG data is wirelessly sent from transmitter to receiver at 2.4 GHz by point to point link.

In order to send digital ECG signals, the ECG data is converted in binary form and inserted into a payload. The payload is consisted of the receiver address and ECG data itself. The receiver address is added to ensure the data is transmitted to the correct

destination. When the ECG signal is transmitted, the transmitter will wait about 15 milliseconds to complete the communication link. If communication link is ready, the transmitter will send the ECG signal to the receiver. In contrary, if the communication link is still not ready in allocated time, the transmitter will retry to establish the link up to 15 times. Finally, following 15 times when the transmitter is failed to establish the connection, the ECG signal transmission is aborted.

The receiver consists of microcontroller and textile antenna. The receiver will receive the transmitted digital ECG data from the transmitter and display the ECG signals on a monitor. Microcontroller converts the digital ECG signals to serial analog data, and is then transferred to a computer via Arduino power cable. A free software is used for displaying the received ECG signals in real time.

### 3. Off-Body Communication Experimental Test

In this research, we apply two investigations that are relating to the communication delay of the wireless system. We have actually conducted two kinds of measurement, those are on-body communication and off-body communication tests, in which each measurement has three different scenarios. When measurement is conducted, the subjects (volunteers) need to keep holding his position up to five minutes while recording the ECG data. Sometimes, when the subject moves around while the recording, noise appears on ECG signals. Subjects are two healthy males with 20 (skinny) and 22 (fatty) years old. The measurement is conducted in sitting condition of the subjects and the textile antenna is placed at the left arm of the subjects. By varying location distance and obstacle environment, the ECG signals are recorded in real time. In order to validate the system performance, the recorded ECG from the proposed system will be numerically compared with the clinical test at clinical healthcare on the same subjects. The following section will discuss each measurement scenario.

#### 3.1. Scenario 1

In scenario 1, the transmitting (Tx) and receiving (Rx) antennas are situated at the left arm of the subjects, subject 1 as Tx and subject 2 as Rx. Subject 1 and subject 2 are situated in the same room at the 4<sup>th</sup> floor of the 4-storey concrete building, described in Fig. 1. The room is equipped by several desks, chairs, small cable poles, and acrylic bulkhead.

The transmitted ECG signal is wirelessly received by subject 2 (Rx antenna) at about 2m of distance, which is shown in Fig. 2. The result show that the ECG signals can be well received at the receiver eventhough there is a bit amplitude fluctuation of QRS-wave peak.



Figure 1. (a) Tx antenna is attached on subject 1; (b) Rx antenna is attached on subject 2.

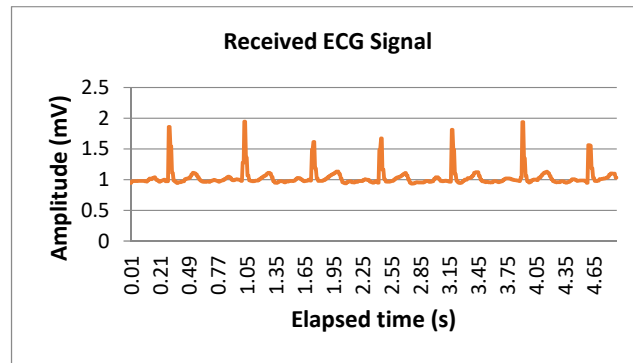

Figure 2. Received ECG signals that are displayed at the receiver for subject 2 (scenario 1).

### 3.2. Scenario 2

In scenario 2, the transmitting (Tx) and receiving (Rx) antennas are situated at the same as the scenario 1, however, subject 1 and subject 2 are separated in the different room at the 4<sup>th</sup> floor of the 4-storey concrete building. The rooms are separated by some acrylic bulkheads at 10-15m of the distance. This scenario is aimed to determine whether the proposed system can send the ECG signal across the obstacle.

The transmitted ECG signal is wirelessly received by subject 2 (receiver) as shown in Fig. 3. The result show that the ECG signals can be well received at the receiver.

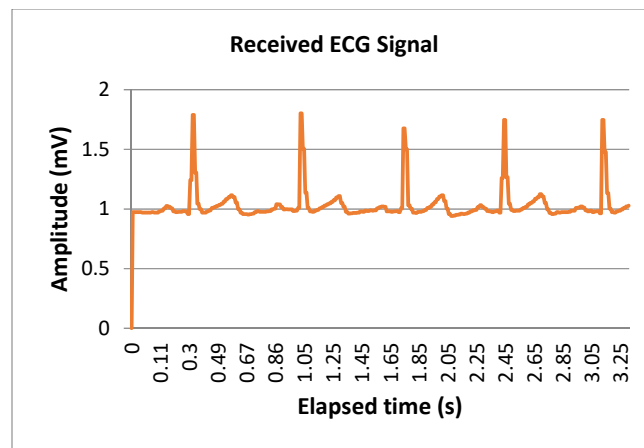

Figure 3. Received ECG signals that are displayed at the receiver for subject 2 (scenario 2).

### 3.3. Scenario 3

In scenario 3, the transmitting (Tx) and receiving (Rx) antennas are situated at the same as the scenario 2, but the room of subject 2 is equipped by some microwave measurement tools, from which some radiation disturbance may exist. This scenario is aimed to verify the signal distortion may occur to ECG data reading due to electromagnetic interference. As a result, the received ECG signals are still well received, as depicted in Fig. 4.

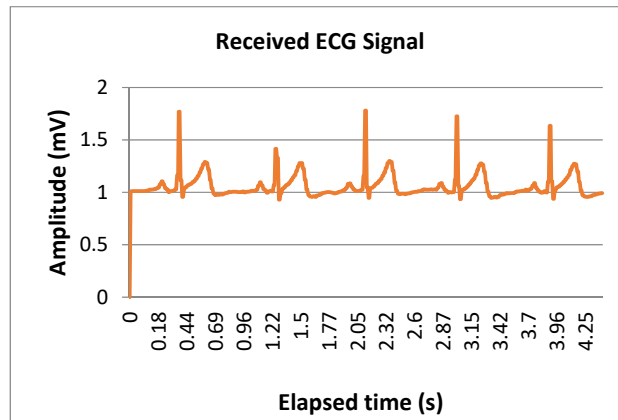

Figure 4. Received ECG signals that are displayed at the receiver for subject 2 (scenario 3).

Table 1. Comparison Results between Lab Measurement and Clinical Test

	RR (s)	PR (s)	P (s)	QRS (s)	ST (s)
Scenario 1	0.86	0.22	0.13	0.10	0.32
Scenario 2	0.88	0.22	0.12	0.11	0.31
Scenario 3	0.87	0.22	0.13	0.10	0.3
Clinical Test	1.2	0.24	0.12	0.12	0.32

When we analyze the ECG signal, it will be grouped into some interval wave, those are RR, PR, P, QRS, and ST wave time interval, which describe the electrical activity in human hearts. From Table 1, the interval has different value among scenarios. However, if we are using the standard time interval, for RR time interval between 0.66 – 1.2 seconds, P time interval is 0.13 seconds, PR time interval 0.12 – 0.24 seconds, QRS time interval 0.12 seconds and ST time interval 0.32 seconds are still within the standard time interval. Hence, the proposed monitoring system supposed to be used for medical diagnostic without giving the false information to the doctor. The delay exists due to the scattering and reflection phenomena when the transmitter send ECG signals. The amplitude fluctuation over time is caused by EM interference in 2.45 GHz band environment.

#### 4. Conclusion

This paper has discussed the evaluation of the proposed patient ECG monitoring system to the off-body communication link. Various off-body link scenarios has been conducted and verified with clinical test results. The experimental results show that the developed system is able to transfer and display real time ECG signals up to approximately 15m of obstruction environment, which the measurement is conducted in a sitting position of volunteers. We have also validated the obtained ECG data, comparing to the data taken from the healthcare clinic equipment. Moreover, according to QRS wave analysis, our ECG signals have reasonable RR, PR, QRS and ST wave time interval comparing to the standard ECG signals.

#### Acknowledgements

This work is partly supported by Hibah Riset RCBE-FTUI 2016. The authors would like to thank to volunteers for evaluating our developed monitoring system.

#### References

- Agung, M.A, Basari (2016). 3-Lead Acquisition using Single Channel ECG Device Developed on AD8232 Analog Front End for Wireless ECG Application. Proc. of the 1st Intl. Symp Biomedical Engineering, Depok, Indonesia.
- Bsoul, M., Minn, H., Tamil, L. (2011). Apnea MedAssist: Real-time Sleep Apnea Monitor Using Single-Lead ECG. IEEE Trans. Information Technol. in Biomedicine, vol. 15, no. 3, pp. 416-427.
- Capua, C.D., Meduri, A., Morello, R. (2010). A Smart ECG Measurement System Based on Web-Service-Oriented Architecture for Telemedicine Applications. IEEE Trans. Instrumentation and Meas., vol. 59, no. 10, Oct., pp. 2530-2538.
- Faezipour, M., Saeed, A., Bulusu, S.C., Nourani, M., Minn, H., Tami, L. (2010). A Patient-Adaptive Profiling Scheme for ECG Beat Classification. IEEE Trans. Information Technol. in Biomedicine, vol.14 , no. 5, pp.1153-1165.
- Jing, Z., Oresko, J., Huang, S., Cheng, A.C. (2009). Heart to Go: A Personalized Medicine Technology for Cardiovascular Disease Prevention and Detection. IEEE Life Sciences System and Application Workshop (LiSSA).
- Kailanto, H., Hyvarinen, E., Hyttinen, J. (2008). Mobile ECG Device Measurement and Analysis System Using Mobile Phone as the Base Station. Proc. of the 2nd Intl. Conf. Pervasive Computing Technol. for Healthcare.

---

**New Paradigm of Marine Paleo-oceanographic Study With  
Spatial Based Reconstruction at Sangiran and Muria Strait –  
Central Java Indonesia**

Agus Hartoko<sup>a</sup>, Siti Aisyah<sup>b</sup>, Josaphat T S Sumantyo<sup>c</sup>, Delianis Pringgenies<sup>d</sup>

<sup>a</sup>Departement of Fisheries. Fac of Fisheries-Agriculture-Biology. University of Bangka Belitung

<sup>bd</sup>Faculty of Fisheries and Marine Science, Diponegoro University, Semarang Indonesia

<sup>c</sup>Center for Environmental Remote Sensing (CERES), Chiba University. Chiba. Japan

---

**Abstract**

The formation of Indonesian islands at the Oligosen 50 – 30 million years, where Indo-Asian peninsular with Sumatera, Java, Borneo, Kalimantan islands plate collided to the Australian and Pacific plate to form Papua Mollucas and Sulawesi islands. The formation Java with the up-lift of the mountainous southern Java by subduction of the Australian plate. Spatial reconstruction concept based on postulate that Muria mountain was before separated with Java island about 50 million years. Satellite data and geological maps were used to analyse the phase of sedimentation process at the era of Pliosen 2-million years and identify the sequence of ancient coastline movement to the unification become the existing Java condition. Collected mollusc fossils samples were analysed using Accelerator Mass Spectrometer (AMS) radiocarbon.

Field validations grouped into 3-phases. Phase-1 the Pliosen era about 2 million years the south Java mountain zone uplift lead to the formation of Sangiran-dome and brackish water swamp palaento-ecology zone. Variety of brackish water and marine Mollusc fossils of *Turritella* sp, *Strobus*.sp, *Murex*.sp, *Ostrea*.sp, *Orthaulax*.sp, *Natica vitellus*, *Telescopium telescopium*, *Anadara* sp, *Dosinia* sp found at “Bukuran village” (“bukur” in Javanese means as gastropods). This mollusc dome characterised with dark high organic clay sediment. Result of AMS <sup>14</sup>C dating revealed that Sangiran sample are 35390 ± 258 and 30216 ± 183 <sup>14</sup>C Age BP (Before Present). The phase-2 expedition discover the ‘ancient fringing-reef’ and mollusc fossils at Grobogan and the ‘trapped ancient seawater’ locally known as ‘Bleduk-Kuwu’ with mud-blow, salt and mollusc fossils of *Antigono chemnitzii*, *Cullelus dilatatus*, *Plotia scabra* and *Tibia modesta*. In geological term the zone known as ‘north Kendeng lime-stone mountain or the front-arch formation’ as the ancient coastline of “Muria strait” that separate Muria mountain and Java and recognised as marine-palaentological zone. Sample of this zone was 23127 ± 107 and 7571 ± 39 <sup>14</sup>C Age BP. Phase-3, Patiayam dome (Ancient Muria Strait) at Kudus revealed vertical eco-geological layers of high organic freshwater, marine Mollusc and coraline marine sediment with fringing-reef fossil. Variety of marine mollusc of *Tridacna*.sp, *Cassis tuberosa*, *Tonna allium*, *Haliotis asinine*, *Terebridae*, *Pseudodon vondenbuschianus*, *Elongaria orientalis*, *Ampullina bandongensis*, *Anadara pilula* and *Filopaludina javanica* with 23871 ± 112 and 12227 ± 56 <sup>14</sup>C Age BP.

**Keywords :** Spatial analysis; marine; paleo-oceanography

Corresponding author : agushartoko@gmail.com



## INTRODUCTION

The formation of Indonesian islands was began at the era of Oligosen 50 – 30 million years, where Indo-Asian with formation of Sumatera-Java and Borneo/Kalimantan islands plate collided with the Australian and Pacific plate to form Papua Mollucas and Sulawesi islands (Hall, 2001). Geological up-lift process by subduction of Australian plate into the Indo-asian plate Sumatra-Java-Kalimantan at the era of Pliosen 2-million years ago to the original coastal line up to the unification become the existing Java condition (Bemmelen, 1970; Louys, and Erik. 2010). The anthropological study by De Graaf and Pigeaud (1985), France historian Lombard (1996) assumed that Muria mountain was before a separated island from Java. Especially in the periode before the 17th century that was separated by a strait. Lombard (1996), Kistanto *et.al.* (2009) describes that old cities of Demak, Jepara, Kudus, Pati, Juwana and Rembang were important key harbours along the north coastal zones of Muria strait that separated of Java and Muria.

Sangiran had been widely known with the discovery site of *Homo erectus* or the man from Java (Bettis, *et.al.* 2004; Bettis, *et.al.* 2009). The study with fundamental concept of discovering Muria mountain as before separated from the main Java island by “Muria strait” and Sangiran dome was before also a marine environment. The study focuses in spatial reconstruction, field validation expeditions and discovering of marine fossils and paleo-oceanographic along the ancient coastal line at the south Muria mountain (Patiayam dome), north carbonate arch of Grobogan, Bleduk Kuwu mud basin up to Sangiran dome of early Pleistocene (ca. 1.60 – 1.02 Ma) as marine environments. Through the discovery, it is hoped as a new marine palaeontological paradigm can be used to develop the past marine ecosystem or a new site for paleo-oceanographic studies.

## METHODS

**Satellite Data.** SRTM - Digital Elevation Model (DEM) data were used for the analysis of the sedimentation phases of the “Muria strait” and the position of the ancient original coastline of north Java, Muria strait and deepsea of Sangiran, Central Java Indonesia. The spatial analysis involving a spectral signature analysis and classification based on the wetness of soil. The spatial models was then used to reconstruct the sedimentation phases of the Muria Strait and the position of the Sangiran sea. The spatial model of the Muria strait and Sangiran coastline was then overlaid with the recent riverine system. Then field sampling site and coordinates were specified based on the position of the ancient coastline coordinates (Hartoko, *et.al.* 2012). Stratigraphic analysis based on Quarternary Environmental Geologic Map of Kudus, Ngawi (Sangiran) and Rembang (Source : Badan Geologi. Pusat Survei Geologi, 2013)

**Field Sampling.** Based on the spatial Muria strait model, with position of the ancient coastal line, then used as guide for the field marine fossil collection coordinates. The field GPS guided expedition was focused on the collection of marine fossils. Such as marine mollusc fossils (Gastrophods and Bivalvia), coral, diatom and foraminifer fossils. Sampling sites were located at Patiayam-Kudus (the south ancient coastal line of Muria mountain), Bendung Klambu and Bleduk Kuwu at Grobogan and Sangiran dome. The study focus on mollusc fossils were sampled from Ancient Muria Strait (Patiayam Archaeological Site), Grobogan and Sangiran (Figure 1 and 2). Field sampling using purposive technique based on coordinate and discussion with site museum staff. Mollusc fossils found then identified to determine genera of mollusc fossils. Identification based to morphometric analysis (Dharma. 2009).

## Radiocarbon Dating Method

The interrelationships and evolutionary history of molluscs have seen great advances in the last decade Vinther, (2015). Radiocarbon Dating is the method for dating analysis using  $^{14}\text{C}$ . In order to evaluate the validity of a  $^{14}\text{C}$  age of any material, the original sources of the carbon must be known. Carbon of gastropod shell carbonate originates from as many as four different sources – atmospheric  $\text{CO}_2$ , food, water, and carbonate rocks Alkass, *et.al.* (2013). Analysis of the age of mollusc fossils with radiocarbon dating method could estimate the ages any organic thing.  $^{14}\text{C}$  is an unstable radioactive isotope. The analysis using Accelerator Mass Spectrometer (AMS) system. AMS detect atoms of specific elements according to their atomic weights. However, do not have the sensitivity to distinguish atomic isobars (atoms of different elements that have the same atomic weight, such as in the case of carbon 14 and nitrogen 14 – the most common isotope of nitrogen). Essentially two parts in the process of radiocarbon dating through AMS. The first part involves accelerating the ions to extraordinarily high kinetic energies and the subsequent step involves mass analysis. Two accelerator systems commonly used for radiocarbon dating through AMS. First is the cyclotron and the second is a tandem electrostatic accelerator (Beta Analytic. 2016; Calibration Online. 2016). The radio-carbon analysis was supported by Micro Analysis Laboratory, Tandem accelerator (MALT), The University Museum, The University of Tokyo, Japan. The protocol of the radiocarbon dating procedure from marine mollusc fossils by Matsuzaki (2015).

Preparation of samples use less than 10 mg, treated twice with 1.2 M HCl for 6 hr at  $80^\circ\text{C}$  to remove any possible carbonate contaminants. Samples were then treated with 0.005 M – 1.2 M sodium hydroxide at  $80^\circ\text{C}$ . Then washed with ultra pure water and treated again with 1.2 M HCl for 2 hour at  $80^\circ\text{C}$ . Removing excess HCl completely from samples, centrifuge and decant were repeated after adding some distilled water. Samples were then dried in an electric oven at  $90^\circ\text{C}$  for small sample add a few hundred-milligrams of CuO powder (Filamentous Copper Oxide II) as a carrier to the sample in the centrifuge tube, to collect carbonaceous materials completely. Total amount of pretreated charred samples was used to produce  $\text{CO}_2$ . Samples were put in Vycor tubes of about 9 mm in diameter, with about 1 g of granular CuO. The tubes were then connected to a vacuum line and sealed to a tube length of 300 mm. The Vycor tubes were heated to  $850^\circ\text{C}$  for 2 hour to completely convert carbon to  $\text{CO}_2$ . The  $\text{CO}_2$  produced was purified cryogenically in a vacuum line and reduce to graphite on about 2 mg Fe powder in the presence of hydrogen. The graphite materials were pressed into aluminum target holders for AMS  $^{14}\text{C}$  dating. The Hox-II standard was used as a  $^{14}\text{C}$ -concentration reference (Matsuzaki. 2015; Pigati, *et.al.* 2006; Nakamura, *et.al.* 2001). The  $^{14}\text{C}$  ages were calibrated to a OxCal (Zaim, Y. 2006).

## RESULT AND DISCUSSION

The result of the digital elevation spatial model for the reconstruction and analysis of the Muria strait was then overlaid with the recent coastal and riverine system as presented in Figure 1 and Figure 2. The oldest coastline was the bluish line zone, followed by the light green zone and finally the orange colour zone identified as the sedimentation phases occur at the ancient Muria strait. The coastline coordinates were use for the field validation of marine fossils, where an ancient fringing reef was found at the south coast of Muria and at the north coast of Grobogan (Figure 1).

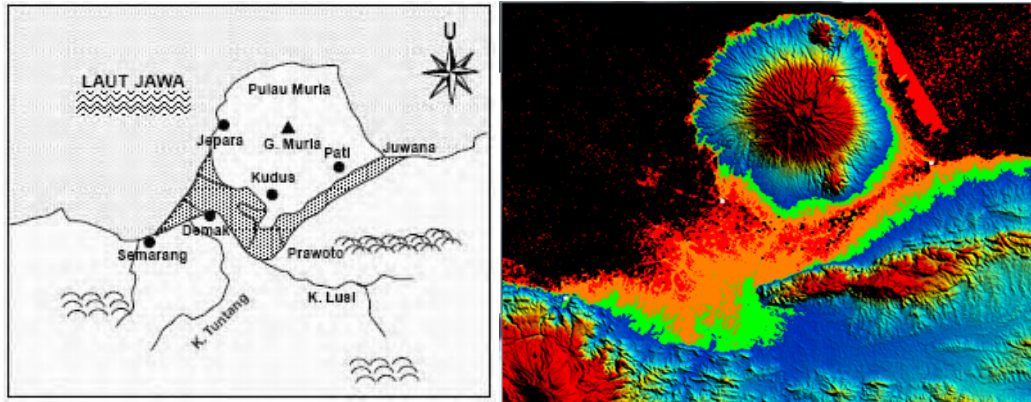

Figure 1. The old map by De Graaf (left) and the satellite data spatial reconstruction model and the sedimentation phases of the Muria strait and the ancient coastal lines (right)

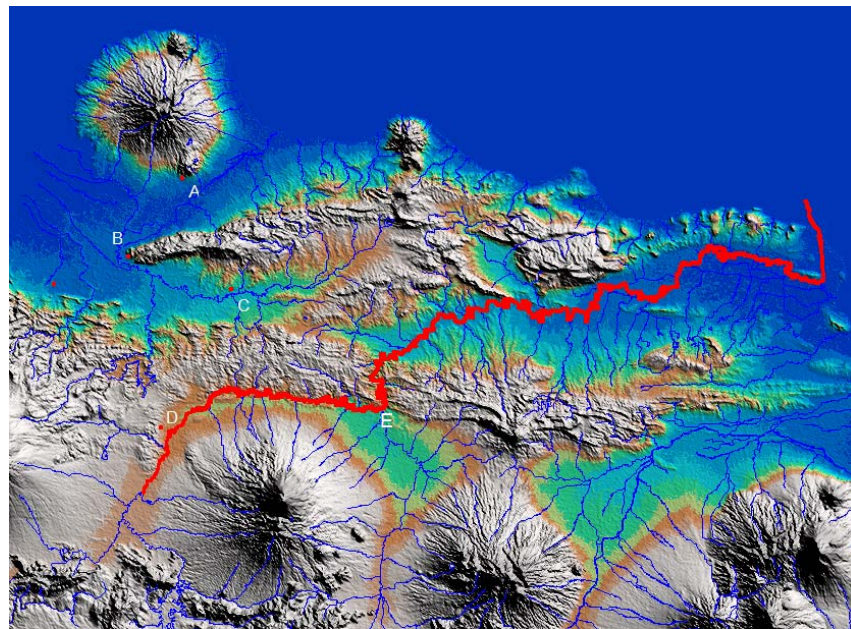

Figure 2. Spatial ancient seas reconstruction of (A)Muria, (B)Grobogan Kendeng - Bendungklambu, (C) Bleduk-Kuwu, (D)Sangiran and (E)Ngawi overlaid with Bengawan Solo and Java riverine system

Stratigraphic study. The Pliosen era about 2 million years the south Java mountainaeus zone was uplifted the north section of Java and lead to the formation of Sangiran-dome and back-swamp palaento-ecological zone. Vertical stratigraphy was started from the lowest layer with Kalibeng formation which is marine environment (1.8 milion year) contains with the blue-clay and followed with foraminiferal limestone. Folowed with Pucangan formation (1.8 - 0.9 million) contains of laharic breccia, black clay, molusca sandy claystone and ditomic clay. Then Grendsbank formation (0.9 - 0.25 million) contains with polimix conglomerates, crossbedding sandstone, tufaceous

sandstone, laharic breccia, tuffaceous sandstone and mud volcano deposits (Badan Geology. 2013; Sartono *et.al.* 1981; Pandita and Yahdi Zaim. 2014).

The important findings at Sangiran dome as the ancient marine environment were the presence of “salt-water capilar” (locally called as Banyuasin site) and marine “Diatome dome” at Pablengan village, coral reef fossils and its associated organisms at Sambungmacan and Ngawi such as tube-worm Polychaeta, Mollusc-dome at “Bukuran” village (“bukur” in Javanese language means as gastropods). The field validation had found variety of a massive marine Mollusc fossils such as *Murex.sp*, *Turritella sp*, *Strombus.sp*, *Ostrea.sp*, *Orthaulax.sp*, *Polinices.sp* (Naticidae) which was also confirmed with the collection of Sangiran Museum, such as *Telescopium telescopium*, *Coniscala.sp* (Superfamily: Epitonacea). The mollusc dome of Bukuran considered as freshwater was characterised with a dark high organic clay sediment (Figure 2). Bettis *et.all.* (2004; 2009) define the overlaying sediments as “black-clay” includes siltstones and mudstones that accumulated in shallow-marine, brakishwater and marsh environments. While at Puren formation on a recent small riverine system abundance of marine genera of mollusc such as *Barbatia* (Arcacea), *Anadara.sp*, *Dosinia.sp*, *Thais.sp*, *Vermetus javanus*, *Volutispina sp*, *Astarte.sp*, *Malea.sp*, *Zaria.sp*, *Vermicularia.sp*, *Inoceramus.sp*, *Levitusia.sp* (Superfamily : Productacea) and *Nerinea.sp* (Nerineaceae) and many other sampels of Gastropod and Bivalvia that are still unidentified had been found. Rare freshwater species *Brotia testudina* (Scalaroidea), *Corbicula. sp* (Myacea), and surprisingly a 2m length giant tube-worm (unidentified) and *Gyroceratites.sp* (Mimocerataceae) and *Nautilus. sp* found at Sambungmacan village, *Balanus.sp* and several genus of Echinoids (*Echinus.sp*; *Nucleolites. sp*) at Tanon district, which all confirm that Sangiran dome as the truth of ancient marine environment were identified using Murray (1986), De Bruyne (2003), Dane (2002), MacDonald (1986). *Nautilus javanus* of upper Miocene is the only cephalopod fossil that has been described from Java. Most important of Sangiran dome was that the lower and middle pleistocene layers bears the most rich of both vertebrate and invertebrate fauna could be assembled (Bemelen, 1970). Good exposure of strata underlying the sub-zone at Sangiran dome (Figure 2, Hartoko. 2012) which has been cut by Tjemoro river was began with bluish gray marine clays and argillaceous sands with marine fossil *Turritella bantamensis* of the upper pliocene. The marine facies terminates with a horizon of *Balanus* limestone, followed by a freshwater mollusc *Turritella - Corbicula* beds of Ngawi. Lower breccias of Sangiran and west Ngawi sub-zone as freshwater lake with intercalation of black clays which contain of diatomaceous beds and yellow marine clay horizon with only half meter thickness proves an invasion of the sea of short duration (Altena, 1938; Bemmelen, 1970; Seisser, *et.al.* 1984; Hallock *et.al.* 2003).

Stratigraphic analysis of the Sangiran dome based on Quarternary Environmental Geologic Map of the Solo-Madiun area explain that Sangiran area were started with Kalibeng formation (Pliocene) with alternation of limestone, marl and marly limestone, silt, tuffeous silt and sandstone. Puren formation with bluish gray silt, limestone, sandy tuff layers moluscs. Karangrejo formation with black clay, tuffaceous silt sand, bone, foram and molluscan fossils. Ngrejeng formation with breccia, alternation of limestone and siltfine sand, conglomerate and silt-fine sand, conglomeratetic sandstone. Gondang formation with sand, tuffaceous silt, thin alternation of sandstone and siltstone. Followed with early pleistocene of Pucangan formation, Sangiran formation, Ketanggung formation. Middle pleistocene with Kabuh formation, Bapang formation, Ngarum formation. Lower Notopuro formation, Pohजार formation, Sidolayu formation, Mlandong member formation, Sugih member formation, Dungus member formation. Upper Notopuro formation, upper Notopuro, upper Sidolayu, Mandang formation. Nglakar formation and Basaltic still. Late Pleistocene, with Setri formation and finished with Holcene with alluvium and tambak formation, alluvium and Sambirejo formation and alluvium and Maron formation. Stratigraphic analysis based on Quarternary Environmental Geologic Map of the Solo-Madiun, Kudus,

Ngawi and Rembang area (Badan Geologi. 2013), supported with spatial reconstruction database (Figure 2). Followed by field validation samples had confirmed that Sangiran and Patiayam-Kudus were the same as pliocene with the oldest formation of blue-mud and Sambungmacan as the deep sea zone. While in between of the above formation was found as the late miocene at Bleduk Kuwu and Bendung Klambu with limestone and identified as shallow seas.

### Morphometric Identification of Mollusc Fossils

The specimens of mollusc fossils were collected from Archeological site of Patiayam (Ancient Muria Strait), Grobogan and Sangiran (Figure 3, 4 and 5).

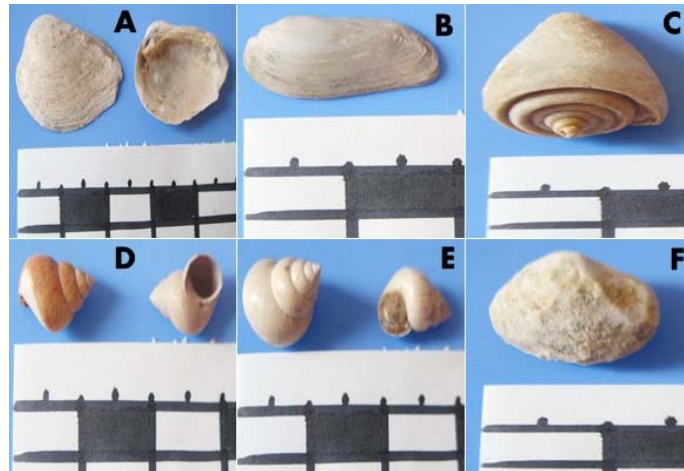

Figure 3. Samples of Patiayam – Muria: A) *Pseudodon vondenbuschianus* length: 49.80 mm height: 29.80 mm; B) *Elongaria orientalis* length: 37.95 mm height: 16.35 mm; C) Terebridae length: 43.70 mm height: 30.75 mm; D) *Ampullina bandongensis* length: 22.05 mm height: 15.25 mm; E) *Filopaludina javanica* length: 27.85 mm height: 18.55 mm; F) *Anadara (cunearca) pilula* length: 28.55mm height: 27.70 mm.

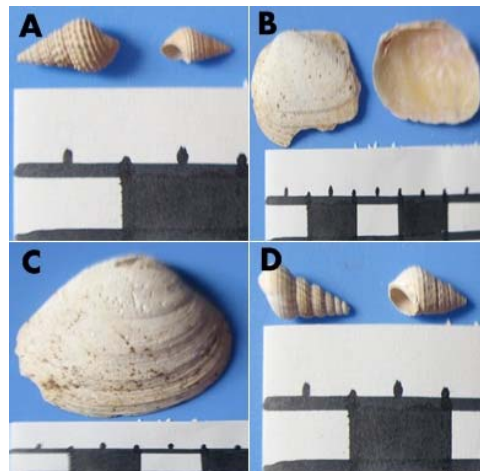

Figure 4. Samples of Grobogan: A) *Plotia scabra* length: 14.05 mm height: 5.05 mm; B) *Cullelus dilatatus* length: 49.60 mm height: 25.05 mm; C) *Antigono chemnitzii* length: 68.05 mm height: 63.30 mm; D) *Tibia modesta* length: 19.75 mm height : 6.10 mm.

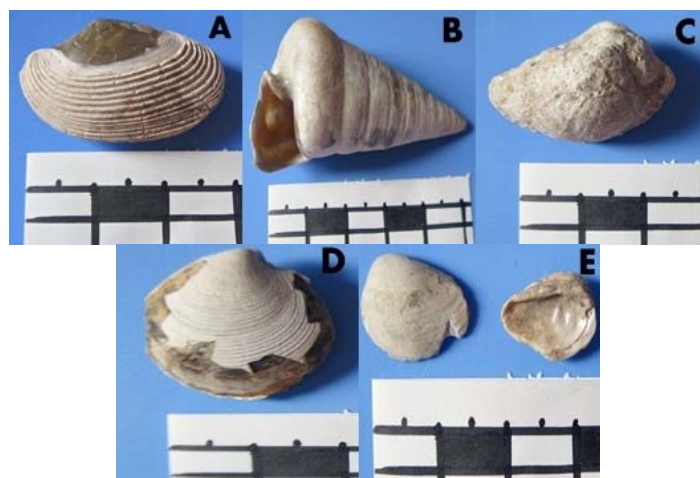

Figure 5. Samples of Sangiran: A) *unidentified* length: 57.60 mm height: 36.05 mm; B) *Telescopium telescopium* length: 111.05 mm height: 57.05 mm; C) *Anadara sp.* length: 55.25 mm height: 38.05 mm; D) *Dosinia insularum* length: 42.05 mm height: 47.05 mm; E) *unidentified* length: 32.05 mm height: 23.05 mm.

### The Age of Marine Mollusc Fossils with Radiocarbon Dating

Result of marine mollusc fossils ages using Accelerator Mass Spectrometry (AMS) radiocarbon through 4 steps : sampel preparation, chemical pretreatment, combustion (oxidation) and sample processing with AMS. The result of marine mollusc fossils  $^{14}\text{C}$  ages has to calibrate using OxCal Calibration (Table 1).

Table 1. Result of  $^{14}\text{C}$  ages and Radiocarbon Ages Calibration

No	No. Sampel	Lokasi	$^{14}\text{C}$ Age (BP/Before Present)	Calibrated Age (BC/ Before Christ)
1	<u>MOL-CD1</u>	<u>Grobogan</u>	<u>23127 ± 107</u>	<u>25692 - 25252</u>
2	<b>MOL-CD2</b>	<b>Sangiran</b>	<b>35390 ± 258</b>	<b>38710 - 37383</b>
3	MOL-CD3	Patiayam - Muria	23871 ± 112	26248 - 25735
4	<u>MOL-CD4</u>	<u>Grobogan</u>	<u>7571 ± 39</u>	<u>6479 - 6379</u>
5	MOL-CD5	Patiayam - Muria	12227 ± 56	12426 - 11994
6	<b>MOL-CD6</b>	<b>Sangiran</b>	<b>30216 ± 183</b>	<b>32672 - 31947</b>

\***Bold**: the oldest area. Underline: the youngest area

The AMS result of  $^{14}\text{C}$  analysis of marine mollusc fossils collected from the Archeological Site of Sangiran, Grobogan and Patiayam (Ancient Muria Strait) on the individual was found with range ages of 6479 – 38710 BC (Table 1), after specific data and using radiocarbon calibrated age using OxCal Calibration (Zaim. 2006; Stuiver, *et.al.* 1986; Nakamura, *et.al.* 2001). The oldest  $^{14}\text{C}$  age of 35390 ± 258 BP was obtained for mollusc sample collected from the Archeological Site of Sangiran, then followed by Patiayam (Ancient Muria Strait) and the youngest was Grobogan zone. Marine mollusc fossils found in Sangiran consists of *Telescopium telescopium* with length of 111.05 mm and height 57.05 mm (Figure 5). This size was found to be much larger than the recent *Telescopium* in general. *Anadara sp.* sample found with morphology intact condition with a length of 55.25 mm and *Dosinia sp.* with a length of 42.05 mm. Sangiran during the Pleistocene become one part of the Java Island have experienced several

deformation due to fluctuations in sea level surface (Rosyidah, 2013). Lithology change step from the ocean turns into a swamp and then go through with land by the activity of an ancient volcano with different formation lithology (Wulandari. 2012). Based on stratigraphic analysis, Sangiran area were started with Kalibeng formation (Pliocene), Pucangan formation (early Pleistocene), Kabuh formation (middle Pleistocene) and Notopuro formation (Wulandari. 2012; Hartoko, *et.al.* 2014). Marine mollusc fossil found near to Kalibeng formation in Puren River and Karangrejo. Field validation sampling had confirmed that the result of radiocarbon dating sample (absolute ages) and geology age were in accordance support the same result. Sangiran was found as the oldest formation as the deep sea zone.

Lithology of Ancient Muria (Patiayam) divided into six formations, that is Jambe formation (Pliocene), Kancilan formation (early Pleistocene), Slumprit formation (middle Pleistocene), Kedungmojo formation, Sukobubuk formation (the end of Pleistocene) and “*endapan teras*” (Holosen). Two formation periods of the environment precipitation in Patiayam, such as Jambe formation in a shallow seas and four formation at the younger area. Kancilan formation was the beginning of the changes to the environment (Mulyaningsih. 2008; Zaim. 2006). The AMS <sup>14</sup>C age samples from Archeological site of Patiayam (Ancient Muria Strait) gave the results: 23871 ± 112 BP and 12227 ± 56 BP with variety of marine mollusc fossils: *Terebridae*, *Pseudodon vondenbuschianus*, *Elongaria orientalis*, *Ampullina bandongensis*, *Anadara pilula* and *Filopaludina javanica* (Figure 3). This formation was found as the late miocene in Grobogan with limestone and identified as shallow seas. The area was found as the youngest area with AMS <sup>14</sup>C results are 23127 ± 107 BP and 7571 ± 39 BP. The zone was known in geological term as ‘the north Kendeng limestone/carbonate mountain or the front-arch formation consisting with the denundation of Globigerina – limestone Hartoko, *et.al.* 2014. The field validation on the coordinate position of Grobogan had discover sampels of limestone sediment and mollusc fossils such as *Antigono chemnitzii*, *Cullelus dilatatus*, *Plotia scabra* and *Tibia modesta*.

**Conclusion.** The study revealed that the archeological site of Sangiran and Patiayam were the same as Pliocene with the oldest formation and appropriate with radiocarbon carbon dating results as the deep sea zone (Sangiran) as well as ancient Muria Strait (Patiayam). While formation found at Grobogan with fringing-reef found as the youngest result of radiocarbon dating.

## **Acknowledgements**

The authors would like very much to thanks to Master Program – Coastal Resources Management. Fac of Fisheries and Marine Science. Diponegoro University, Semarang - Indonesia for the local funding. A special thanks to Prof. Hiroyuki Matsuzaki for the generous support of the Micro Analysis Laboratory, Tandem accelerator (MALT), The University Museum, The University of Tokyo, Japan for the carbon dating of marine fossils analysis. A sincere thanks to all Sangiran museum staff and local villagers at Sangiran (Mr Bambang and Mr Tanto), Bendung Klambu, Bleduk Kuwu and Patiayam (Mr. Takim, Ms. Siti) - Muria. Thanks to University of Bangka Belitung – Indonesia for the accomodation and transport fund to join the IJSS-2016 at Chiba University-Japan.

## **References**

Alkass, K., Hisako, S., Bruce, A. B., Samuel, B., Gunilla H., David, R. S., Kirsty, L. S., and Henrik, D. 2013. Analysis of Radiocarbon, Stable Isotope and DNA in Teeth to Facilitate Identification of Unknown Decedents. [www.plosone.org/journal.pone.0069597](http://www.plosone.org/journal.pone.0069597). 12 pp.

- Altena, C. O. van R. 1938. The Marine Mollusc of the Kendeng Beds (East Java) Gastropods, Part I (Families Fissurellidae-Vermetidae inclusive), Overdr. UitLeidsche Geologische Mededeelingen, Dool X, Leiden.
- Badan Geologi. 2013. Pusat Survei Geologi. Bandung
- Bemmelen, R.W., 1970. The Geology of Indonesia. The Hague, Martinus Nijhoff, vol.IA.
- Bettis III,EA, Zaim, Y Larick, R Ciochon, RL Suminto, Rizal.Y, Reagan.M, Heizler M. 2004. Landscape Development Preceding *Homo erectus* immigration into Central Java. Indonesia : the Sangiran Formation Lower Lahar. *Paleogeogr. Palaeoclimatol. Palaeoecol.* 206 : 115-131
- Bettis III,EA, Adrienne K Milius, Scott J Carpenter, Roy Larick, Yahdi Zaim, Yan Rizal, Russel L Ciochon, Stephaine A Tiessier-Surine, Daniel Murray, Suminto, Sutikno Bronto. 2009. Way out of Africa : Early Pleistocene Paleoenvironments inhabited by *Homo erectus* in Sangiran Java. *J of Human Evolution. Elsevier.*
- Beta Analytic. Co. Ltd. 2016. Accelerator Mass Spectrometry Radiocarbon Dating. [www.radiocarbon.com](http://www.radiocarbon.com) (12 January 2016).
- Bruyne, RH. 2003. The Complete Encyclopedia of Shells. Rebo Production.
- Calibration Online. 2016. University of Oxford. Radiocarbon Calibration. <https://c14.arch.ox.ac.uk/> (18 January 2016).
- Dane, SP. 2002. Shells. Smithsonian Handbooks. DK.Pubs. London
- De Graaf, HJ and Th.G Pigeaud. 1985. Kerajaan-Kerajaan Islam di Jawa : Peralihan Dari Majapahit ke Mataram. (The Islamic Kindom and Transition from Majapahit to Mataram). Grafiti Pers.
- Dharma, B. 2009. Recent and Fossil Indonesia Shells. Conch Book. ISBN-10: 3925919708. 150pp.
- Hall, R. 2001. South East Asian Plate Tectonics. SEA Research Group. Univ of Hull. UK
- Hallock.PA, B.H Lidz, E.M.Cockey-Burkhard and K.B.Donnely. 2003. Foraminifera as Bioindicators in Coral Reef Assessment and Monitoring : The Foram Index. *Environmental Monitoring and Assessment.* 81 : 221-238.
- Hartoko,A. 2012. Spatial Algorithms Developments for the Reconstruction of Ancient Seas of Java. Lecture Material: Master Program - Coastal Reources Management. Diponegoro University-Semarang.
- Hartoko, A., Hariyadi, Petrus, S., Josaphat, Tetuko S. 2014. Satellite Data Spatial Based Reconstruction and Discovery of the Ancient Coastline, Coral-fringing Reef and Mollusc Fossils at The Muria Strait – Central Java Indonesia. The 6<sup>th</sup> Indonesia Japan Joint Scientific Symposium. 15 pp.
- Kistanto.NH, Hartoko.A, J.Rais. 2009. Studi Antropologi Maritim dan Pengembangan Basisdata Spasial (Maritime Anthrophological Study and Spatial Database). Lap. Hibah Fundamental-Undip. DP2M-DIKTI.
- Lombard, D. 1996. Nusa Jawa : Silang Budaya, Kajian Sejarah Terpadu (Nusa Jawa: Integrated Historical Cstudy). Gramedia.
- Louys, J. and Erik, M. 2010. Palaeoecology of Southeast Asian megafauna-bearing sites from the Pleistocene and a review of environmental changes in the region. *Journal of Biogeography.* Blackwell Publishing Ltd. Research Centre in Evolutionary Anthropology and Palaeoecology, School of Natural Sciences and Psychology, Liverpool John Moores University, Liverpool L3 3AF, UK. 18 pp.
- MacDonald. 1986. Encyclopedia of Fossils. MacDonald & Co. Publishers.Ltd.
- Matsuzaki, H. 2015. Radiocarbon Dating. Micro Analysis Laboratory, Tandem accelerator (MALT), The University Museum, The University of Tokyo, Japan.



- Murray, JW. 1986. Atlas of Invertebrate Macrofossils. Longman. The Palaentological Association.
- Mulyaningsih, S. *et al.* 2008. Vulkanisme Kompleks Gunung Patiayam di Kecamatan Jekulo, Kabupaten Kudus, Provinsi Jawa Tengah (Vulcanism of the Patiayam Jekulo-Kudus Central Java). *Jurnal Geologi Indonesia*, 3(2): 76-86.
- Murray, JW. 2006. Ecology and Applications of Benthic Foraminifera. Cambridge Univ Press.
- Nakamura, T., Taniguchi, Y., Tsuji, S., and Oda, H. 2001. Radiocarbon Dating of Charred Residues on The Earliest Pottery in Japan. *Radiocarbon Journal* 43(2B). 1129-1138.
- Pandita H and Yahdi Zaim. 2014. Paleoekologi Formasi Pucangan di Daerah Kabuh Ditinjau Dari Kandungan Fosil Moluska (Palaecology Formation of Pucangan at Kabuh Based on the Mollusc Fossils). Geologi, STTNAS Yogyakarta and Institut Teknologi Bandung. [www.academia.edu](http://www.academia.edu).
- Pigati, J. S., Rech, J. A., and Nekola, J. C. 2006. Collaborative research: Radiocarbon dating of North American terrestrial gastropod shells. National Science Foundation Sedimentary Geology and Paleobiology Competition Award #EAR 0614840, pp 1.
- Rosyidah, M. Y. 2013. Rekonstruksi Lingkungan Purba di Situs Sangiran pada Kala Plestosen Menggunakan Analisis Mesowear pada Fosil Bovidae (Reconstruction of the Ancient Sangiran Using Mesowear Analysis of Bovidae Fossil). *Jurnal Sangiran* (2). 91.
- Sartono S, Orchiston,DW, Sesser,WG, Djubiantono,T. 1981. Upper Pliocene sediments in Sangiran, Central Java Indonesia. *Bull.Geol. Institut Teknologi Bandung*. 5:1-25
- Seisser,WG, Orchiston.DW, Djubiantono,T 1984. Micropalaentological investigation of late Pliocene marine sediments at Sangiran, Central Java. *Alcheringa* 8:87-99
- Stuiver, M., Pearson, G. W., and Braziunas, T. 1986. Radiocarbon Age Calibration of Marine Samples Back to 9000 Cal Yr BP. *Radiocarbon Journal* 28(2B). 980-1021.
- Vinther, J. 2015. *Frontiers in Paleontology - The Origins of Molluscs*. *Paleontology Journal*. 58(1), 19-34.
- Wulandari. 2012. Topografi Situs Sangiran. *Jurnal Sangiran* 1 (2012), hlm.14-16.
- Zaim, Y. (2006). Hominids in Indonesia: From *Homo erectus (paleojavanicus)* to *Homo floresiensis*. In : Mulyaningsih, S., Vulkanisme Kompleks Gunung Patiayam di Kecamatan Jekulo, Kabupaten Kudus, Provinsi Jawa Tengah. *Jurnal Geologi Indonesia*. 14 pp.

---

## **Applied technology to produce free oxygen in closed room to prevent haze**

Tengku Dahril\* Aras Mulyadi<sup>1</sup> and Efawani

*Faculty of Fisheries and Marine Science University of Riau. Kampus Bina Widya Km 12.5, Simpang Baru, Pekanbaru 28284 Riau, Indonesia*

---

### **Abstract**

Since 1991, haze has been a particularly acute problem in Southeast Asia, especially in Indonesia, Malaysia and Singapore. Many people especially children and old man have been illness by upper respiratory tract infection (URI). The main sources of the haze has been forest fires in Sumatra and Kalimantan. In order to solve this problems, the study was conducted using microalgae (*Chlorella* sp) that cultured in Dahril bottle to produce free oxygen and to prevent haze in closed room.

Dahril bottle made by glass bottle that facilitated by five main components namely, two daylight fluorescent lamps that put on the top and on the bottom of glass bottle, air pump to supply carbodioxide, distilled water as culture media, nutrient and *Chlorella* sp as a seed of microalgae.

First step to operate Dahril bottle is to wash the bottle with clean water and rinse with hot water to kill bacteria and fungi. Then, Dahril bottle was filled with distilled water and enriched with macro and micro nutrients. First sources of nutrient made by pure chemical materials and the second came from wastewater of palm oil mill effluent that was filtered with Dahril filters made by a drum that were, gravel, sand, coal and palm fibre in side as natural filters. The concentrations of two solution (Chemical and palm oil wastewater) used in this study was 10 %. The media culture than inoculate with *Chlorella* with initial density of  $5 \times 10^4$  cells/ml. *Chlorella* has been grow well for two weeks or more.

In order to know the effect of Dahril bottle with *Chlorella* inside to prevent haze and to produce free oxygen in the closed room, two glass boxes were prepared. Both boxes were filled with artificial haze. One of the box was put a Dahril bottle with *Chlorella* growing well inside, and another none. Oxygen concentration in both boxes were measured by oxygenmeter before and after one hour Dahril bottle put inside. The result of this study indicated that Dahril bottle can eliminated haze and produce free oxygen 0.8-1.6 % higher than box without Dahril bottle inside.

*Chlorella* grow well in Dahril bottle. The cell can split two to four times a day. Water colour would be changed from white clear to leave green colour because of Chlorofill-a or green pigment. Photosynthesis continuously conducted with chemical reaction as follow,  $6 \text{CO}_2 + 6 \text{H}_2\text{O} \rightarrow \text{C}_6\text{H}_{12}\text{O}_6 + 6 \text{O}_2$ .

Dahril bottle with *Chlorella* inside will be useful not only for oxygen produce but also for (1) room decorator, (2) carbon dioxide absorb (3) supplement food for animal and human being, (4) natural food for zooplankton and fish larvae (5) as media in teaching and learning by the teacher and student in the school, (6) as media for the preachers to explain the kauniah verses (7) to enhance room humidity and (8) to decrease waste water pollutant.

**Keywords:** *Chlorella* sp, free oxygen, Dahril bottle, haze.

---

### **Introduction**

Haze is traditional an atmosphere phenomenon where dust, smoke, smog and other dry particles obscure the clarity of the sky. Since 1991, haze has been a particularly acute problem in Southeast Asia, especially in Indonesia, Malaysia and Singapore. The main sources of the haze has been forest fires in Sumatra and Kalimantan.

In 2015, due to forest fires in Sumatra and Kalimantan Island, Indonesia the capital city of Malaysia, Kuala Lumpur and surrounding areas became shrouded in a pall of noxious fumes, smelling of ash and coal for more than one month. The main sources of haze where the farmers plantation of their ownland and miners have set hundreds of the fires in the forest to clear land during dry weather. Wind blow most of the fumes across the narrow strait of Malacca to Malaysia and Singapore, although parts of Indonesia especially Pelalawan District of Riau are also affected.

In order to solve these problems, the study has been conducted using microalgae (*Chlorella* sp) where cultured in Dahril bottle to produce free oxygen ( $O_2$ ) and to eliminate haze impact in closed room (Dahril, 2015, 2016) Microalgae is a pioneer organisms that living in the ocean for a long period of ancient times. They play an important role to transform carbon dioxide and water to the ingredients for animal and human being and free oxygen in the water and in the air (sky). The microalgae can grow quickly under good and extreme conditions (salt, alkaline, hot, cold, etc). Microalgae is a small, renewable bio-energy for human and environmental sustainable today and tomorrow.

### **Materials and Methods**

Dahril bottle is a container of bottle that is used as a place to culture microalgae in an enclosed area in this study. Dahril bottle is made of glass jars equipped or modified with five main components namely fluorescent lamp as a light source, air pump or water pump as a mean to supply carbon dioxide, distilled water as a culture medium, macro and micro nutrients, and seed of microalgae (*Chlorella* sp) as a seed to be developed.

Two daylight fluorescent bulbs are placed on the top lid and in the bottom of the pedestal/base of the bottle. The light serve as a replacement of sun light for supply of energy for microalgae to photosynthesize by utilizing carbon dioxide ( $CO_2$ ) and water ( $H_2O$ ) which produce carbohydrate ( $C_6H_{12}O_6$ ) and oxygen free ( $O_2$ ). In addition they are also able to take advantage of macro and micro nutrients dissolved in water as inorganic material which could be changed into organic matter in the form of protein, fat, vitamins and minerals that are needed in the lives of animals and humans as food sources.

The initial step in the use of Dahril bottle is by cleaning the bottle well and then rinsed with hot water (boiling), in order to kill bacteria and fungi. Then the Dahril bottle was filled with 4 liters of distilled water with the capacity size of the bottle. 6-liters. Two kinds of nutrient sources were prepared to grow of microalgae. One of the nutrients made by pure chemical that we call it (Dahril Solution 1, and another one made by wastewater from Palm Oil Industry that we call it Dahril Solution 2). The material of Dahril Solution 1 made by Chemical manufactured namely, 1)  $KNO_3$  1000 mg/l, 2)  $MgSO_4$ , 250 mg/l, 3)  $K_2HPO_4$  250 mg/l,  $NaCl$  100 mg/l,  $CaCl_2 \cdot 2H_2O$  10 mg/l, then Fe-solution, 1 ml/l and trace metal solution 1 ml/l. Fe solution made by  $FeSO_4 \cdot 7H_2O$  2000 mg/l and  $Na_2EDTA$  as much as 189 mg/l per 1 litre aquades. Trace metal solutions made by 1)  $H_3BO_3$  2860 gr/l, 2)  $MnSO_4 \cdot 7H_2O$  2500 mg/l,  $ZnSO_4 \cdot 7H_2O$  225 mg/l,  $CuSO_4 \cdot 5H_2O$  71 mg/l dan  $Na_2MoO_4$  21 mg/l per 1 litre aquades. All of these chemical substances can be purchased from the local stores. The second source of the nutrient came from waste

water of palm oil mill effluent that was filtered with Dahril filters made by a drum that were, gravel, sand, coal and palm fibre in side as natural filters. The concentrations of two solution (Chemical and palm oil wastewater) used in this study was 10 %.

Into the water medium then was inoculated the seed of microalgae in initial density of  $5 \times 10^4$  cells/ml. After that, Dahril bottle was ready to use in his studies. By connecting this bottle with an electric current, both lamps glowed once the air pump was functioning properly. Thus, the process of photosynthesis can take place continuously that will generate free oxygen, while absorbing carbon dioxide from the surrounding air

In order to know the effect of Dahril bottle with Microalgae growing inside, to produce free oksigen and to eliminate haze, two boxes were used. The boxes were made by glass with size 50 x 50 x 60 cm. In side of the two boxes were filled with artificial smoke by fire the coconut fiber. One of the box was put Dahril bottle with Chlorella growing inside, and one none. Concentration of free oxygen and temperature were measured in this two boxes, before, after artificial smoke was filed and after one hour Dahril bottle was operated by oxygenmeter merk Lutron DO-5510.

## Results and Discussion

### Chlorella Gowth in Dahril Bottle

It was founded that *Chlorella* sp has been growing well in Dahril bottle with two kinds of nurient sources namely puce chemical ( Dahril Solution 1) and wastewater from palm oil industry (Dahril Solution 2) . The best growth was founded in Dahril Solution 1 with cell density of 6.8 cells/ml in day 12 compared with Dahril Solution 2 (Palm Oil Waste water) with cells density of  $1,4 \times 10^6$  in day 13 as shown in fig1.

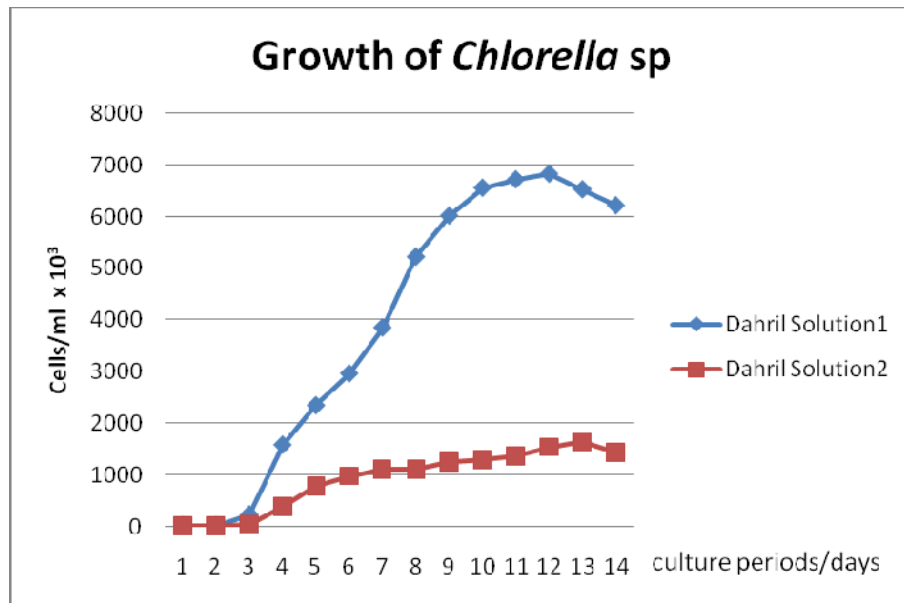

Fig 1. Growth of *Chlorella* sp in Dahril Solution 1 (Pure Chemical) and in Dahril Solution

2 (Palm Oil Wastewater) .

The effect of Dahril bottle with Dahril Solution 1 with Chlorella growing well inside to produced free Oxygen and to eliminate haze was shown in Table 1. Based on the table 1, it could be known that Chlorella could be supply oxygen in the closed room and eliminated haze.

Table 1. Concentration of free oxygen with and without Dahril bottle inside

Treatment	Parameter	Before smoke	After smoke	After Dahril bottle entered
P0	Temperature (°C)	32.54	34.72	33.24
	Oxygen concen (%)	20.4	16.76	18.54
P1	Temperature (°C)	32.56	34.66	33.16
	Oxygen concen (%)	20.4	16.74	19.38
P1-P0	Temperature (°C)	0.02	-0.06	-0.08
	Oxygen concen (%)	0,0	-0.02	0.84

Oxygen is necessary to sustain most terrestrial life especially for human and animal. Oxygen is used in celluler respiration and many major classes of organic molecules in living organisms contain oxygen, such as proteins, nucleic acids, carbohydrates, and fats, as do the major constituent inorganic compounds of animal shells, teeth, and bones. Most of the mass of living organisms is oxygen as a componen of water and carbon dioxide. Oxygen is too chemically reactive to remain a free element in air without being continuously replenished by the photosynthetic action of living organisms. Another form (allotrope) of oxygen, ozone (O<sub>3</sub>), strongly absorbs ultraviolet UVB radiation and the high-attitude ozone layer helps protect the biosphere from ultraviolet radiation. But ozone is a pollutant near the surace where it is a by-product of smog. At low earth orbit altitudes, sufficient atomic oxygen is present to cause corrosion of space craft.(Wikipedia.org)

Common use of oxygen includes residential heating, internal combustion engines, production of steel, plastics and textiles, brazing, welding and cutting of steels and other metals, rocket propellant, oxygen therapy, and life support system in aircraft, submarine, spaceflight and diving.

Photosynthesis splits water to liberate O<sub>2</sub> and fixed CO<sub>2</sub> into sugar in what is called a Calvin cycle. In nature, free oxygen is produced by the light-driven splitting of water during oxygenic photosynthesis. According to some estimates, green algae and cyanobacteria in marine environments provide about 70 % of the free oxygen produced on Earth, and the rest is produced by terrestrial plants. Other estimates of the oceanic contribution to atmosphere oxygen are higher, while some estimates are lower, suggesting oceans produced ~ 45 % of Earth's atmospheric oxygen each year.

A simplified overall formula for photosynthesis is



or simply

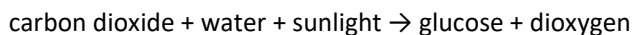

During a dry season in August to October almost every year, haze has been a main problem in Southeast Asia, especially in Riau and Sumatra. At the time, the oxygen concentration in the atmosphere around Pekanbaru city, the capital of Riau Province, decrease from 20.8 % in normally

to 15 or 10 %. Upper respiratory tract infection (URI) has been the most common acute illness of the people in this condition. Many people especially children under five years old and old man and woman have been ill by upper respiratory tract infection (URI). Some of them died. The main source of the haze comes from forest fires in Sumatra and Borneo. In 2015, due to forest fires in Sumatra, Kalimantan Indonesia the capital city of Malaysia, Kuala Lumpur and surrounding areas also became shrouded in a pall of noxious fumes, smelling of ash and coal for more than one month. By this condition, we suggested that a Dahril bottle with *Chlorella* growing inside could be used to solve these problems.

### **Conclusion**

Based on this study, it could be concluded that a Dahril bottle with microalgae, *Chlorella* sp growing inside could be used to increase the oxygen concentration in a closed room. *Chlorella* sp would be growing well with pure chemical (Dahril Solution 1) as well as wastewater from palm oil industries (Dahril Solution 2) as nutrition for their growth. Therefore, it is hoped that a Dahril bottle with Dahril Solution 1 and 2 as nutrient sources could be adopted as a culture medium of *Chlorella* sp to produce free oxygen and to eliminate haze impact in the closed room.

### **Acknowledgment**

This study was supported by the Research and Development Board, Government of Pelalawan District, Riau, Indonesia. We wish to thank the Regent of Pelalawan Regency, for kindly supporting this work. We also would like to thank some of our students with their dedication to support this study.

### **References**

- Anne M, 2016. Upper Respiratory Tract Infection. Emedicine medscape. Or (collected form internet)
- Dahril, T, 2015. Cultured of microalgae (*Chlorella* sp) in Dahril Bottle. Proceeding of the Seminar and Exhibition on New Development of Ocean Energy in Asia Pacific, Jakarta 23<sup>th</sup>-26<sup>th</sup>, 2015. 8 p.
- Dahril, T. 2016. The growth and production of mikroalgae (*Chlorella* sp) using wastewater from palm oil industry as culture medium in Riau Province. Proceeding of National seminar on Fisheries and Marine Science, in Pekanbaru, Riau Indonesia, 26 September 2016. 9 p.
- Wikipedia.or 2016. Haze. Last edited by Yurivict. (Collected form internet)
- Wikipedia.or. 2016. Oxygen. Last edited by BGManofid. (collected form internet)



**The 7th Indonesia Japan  
Joint Scientific Symposium  
(IJSS 2016)  
Chiba, 20-24 November 2016**

---

---

**The utilizations of wastewater from palm oil industry as culture medium for microalga (*Chlorella* sp) growth and production in order to eliminate water pollution in Riau Province**

Tengku Dahril\*, Aras Mulyadi\*, Efawani\* and Subhan Riza\*\*

*Faculty of Fisheries and Marine Science, University of Riau, Pekanbaru\**  
*Research and Development board, Riau Province Government\*\**

---

**Abstract**

Palm oil industries has been developing quickly in Riau Province. Right now, at least, 245 palm oil industries present in through around of district in Riau Province. they discharges not only liquid waste in vast amount but also solid and gas. The liquid waste is rich in micro and macro nutrient that can be used as culture medium of microalgae (*Chlorella* sp).

The study of utilization of waste water from oil palm industry as culture medium for microalgae (*Chlorella* sp) in order to eliminate water pollution in Riau Province was conducted from July to August 2016. Preliminary study was conducted with concentration of 0.0 %, 25 %, 50 %, 75 % and 100 % of waste water that collected from palm oil industri in Tandun, Kampar, Riau. Freshwater *Chlorella* with initial density of  $5 \times 10^4$  cells/ml were inoculated to each culture medium. The algae was cultured in simple incubator, illuminated by two daylight fluorescent lamp with light intensity of 2000 lux at temperature 23 to 28 °C. The density of *Chlorella* was enumerated every three day, for 12 days cultured periods.

Result of this preliminary study indicated that palm oil waste water can promote the growth of *Chlorella* sp. The high density of *Chlorella* sp was found at the concentration of 25 % palm oil waste water, with cell density reached of  $3.3 \times 10^6$  cells/ml. Based on the result of the preliminary study the second study was continued with lower concentration of waste water, namely, 0.0 %, 10 %, 20 % and 30 %. The growth and production of *Chlorella* sp were measured at the end of this study.

The result of the second study indicated, the high density of *Chlorella* sp was found at concentration of 20, % of waste water with cell density of *Chlorella* sp reached  $6.5 \times 10^6$  cells/ml and biomass reached about 0.36 g/l. The concentration of nitrate in culture medium decreased from 13.8 mg/l at the beginning of this study to 2.4 mg/l at the end and phosphate decreased from 2.26 mg/l at the beginning of this study to 0.17 mg/l at the end of 22 days study periods.

Based on this study, it can be concluded that waste water from Palm oil industry can promote the growth and production of *Chlorella* sp, and effectively used to decrease the concentration of water pollutants especially nitrate and phosphate in waste water from palm oil industry in Riau Province.

**Keywords**

Palm oil wastewater industry, *Chlorella* sp, water pollution



### **Introduction**

Riau is a largest number of palm oil plantation in Indonesia with areas of 2.399.173 in 2014. The production of Crude Palm Oil (CPO) reached 7,047,221 ton in 2014 produced by 245 of Palm oil Industries. The Palm Oil Industry generates large quantity of wastes whose disposal is a challenging task. They also gives rise to highly polluting waste-water, known as Palm Oil Mill Effluent (POME), which is often discharged in disposal ponds, resulting in the leaching of contaminants that pollute the groundwater and soil, and in the release of methane gas into the atmosphere. POME could be used for biogas production through anaerobic digestion.

In a conventional Palm Oil Mill, 500-700 kg of Pome is generated for every ton of processes press fruits bunches (FFB). Most of the Biomass residues from Palm Oil Mills are either burnt in the open or disposed off in waste ponds. The Palm Oil Industry, therefore contributes significantly to global climate change by emitting carbon dioxide and methane

Wastewater production from all palm oil industries in Riau are estimated to be 29.250.000 ton/year (Riaupos, Sunday, 30 August 2015). This wastewater contain biological oxygen demand (BOD) estimated to 8,200-35,00 mg/l, Chemical Oxygen Demand, 15,103 - 65,100 mg/l, Total Solid Suspended (TSS) estimated to be 1,220-50,700 mg/l, oil and lipid estimated to 150 -14,700 mg/l (Dirjen PPHP, 2006). Therefore, it is very important to conduct a research to eliminate the effect of wastewater Oil Palm Industry in Riau province.

**Chlorella** is a potential food source because it is high protein and other essential nutrients when dried, it s about 45 % protein, 20 % fat, 20 % carbohydrate, 5 % fibre, and 10 % minerals. It is also abundant in calories and vitamins. Chlorella is also suggested as an inexpensive protein supplement to human and animal diet. Under certain growing condition, Chlorella yields oils that are high in polysaturated fats

Chlorella is a pioner organisms living in the ocean for along periods of time. They are (sun) light driven cell factories that transform carbondioxide (CO<sub>2</sub>) into: ingredients for feed and food, free Oxygen (O<sub>2</sub>), and biomass for feed stock adn bio-fuels. They can grow fast under extreme condition (salt, freshwater, alkaline, hot etc, yield up to 10 times that of traditional crop and do not compete with traditional crops for food, and can be used marginal land. They can absorb many in-organic materials from wastewater such as nitrogen, phosphore, kalium, magnesium, ferum, and others so they can be able to clean the dirty water (purify). In this study we use wastewater from palm oil industries to grow and produce Chlorella sp in order to elimanated water polution from palm oil industry in Riau Province.

### **Materials and Methods**

This study was conducted in two steps. Step one we call a preliminary study with high concentration of palm oil wastewater, and the second steps with low concentration of wastewater. Wastewater from Palm Oil Industry belong to PTPN V Tandun, Kampar. Riau was collected and filtered with Dahril Filter. Dahril filter is a tool specially designed to filter the palm oilmill effluent (wastewater). Dahril filter was made by a plastic drum with gravel, sand, coal and palm fibres inside. The Dahril filter was filled with wastewater through filter substrate than the wastewater was boiled as long

as 20 minute to kill bacteria and fungi. The wastewater than was filtered again through membrane filter (1  $\mu$  pore size). This filtered wastewater was put in 400-ml plastic bottle, that call it **Dahril Solution**, that can be used in this experiment. This wastewater was diluted by adding distilled water with the high concentration of 0,0 %, 25 %, 50 %, 75 %, and 100 % as preliminary study in 400 ml- culture medium.

*Chlorella* sp, obtained from freshwater Aquaculture Research Centre, Depok, West Jawa, was inoculated with initial density of  $5 \times 10^4$  cells/ml in 600 ml flasks for each treatmens. All growth studies were conducted in triplicate. Algae were cultured in a simple incubator with continuous aeration, illuminated by two daylight fluorescent lamps with a light intensity of 4000 lux and temperature between 23 to 28°C. The algae density was enumerated daily for 12 d using a thomacytometer under a binocular microscope.

Based on the result of the preliminary study in treatment 1, the study was continued with low concentration of wastewater namely 10 %, 20 % and 30 %, and 0 % as control. The study was conducted in 6 l-plastic bottle with culture medium 4 l each treatments and continuously aerated in outdoor room. The light come from sunlight directly with room temperature about 28 to 33°C. Chlorella was inoculated with initial density of  $5 \times 10^4$  cells/ml. The number of algae cells was enumerated daily for 22 d using thomacytometer under binocular microscope. After 22 days of culture periods, all biomass algae were harvested and dry weight of algae were measured using analitic balanced. Concentration of nitrate and phosphate before and after algae culture were also measured.

### **Results and Discussion**

It was founded that wastewater from palm oil industry in Riau Province supported the growth of *Chlorella* sp. The best growht of Chlorella was founded in the low concentration of wastewater (25 %) compared with high concentration (50 %, 75 % and 100 %), with total density of  $3,3 \times 10^6$  cells/ml at day 12 (fig 1)

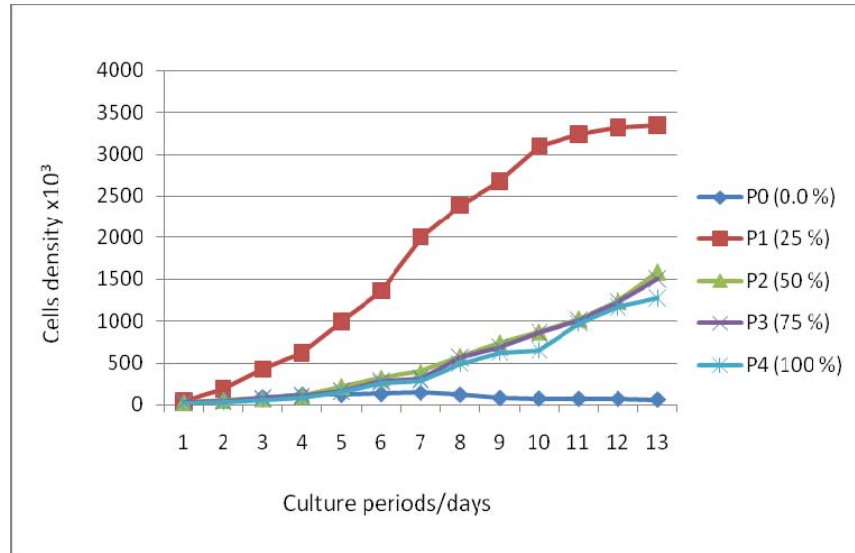

Fig 1. Growth of *Chlorella* sp with high concentration of palm oil wastewater

Based on the result of this preliminary study, the experiment was continued with the concentration of 0.0 %, 10 %, 20 %, and 30 %. The result of the second experiment, it was founded that concentration of 20 % of wastewater was better compare with concentration of 10 % and 30 %. High concentration of *Chlorella* sp was found in 22 days with total density of  $6.6 \times 10^6$  cells/ml as shown in fig 2.

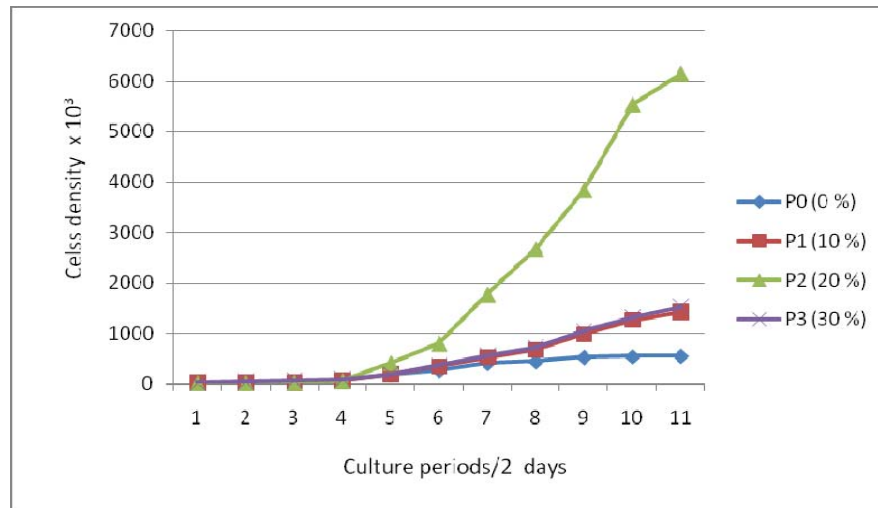

Fig 2. Growth of *Chlorella* sp with low concentration of palm oil waste water.

At the end of this study, the total cell density and biomass of *Chlorella* were also found higher in the concentration of 20 % with total number of 0,36 gr/l as shown in tabel 1.

Table 1. Total cell density and biomass at the end the study

Treatmens	Cell density (Cells/ml)	Biomass (gr/l)
P0 (0 %)	550.667	0.05
P1 (10 %)	1.422.000	0.17
P2 (20 %)	6.145.333	0.36
P3 (30 %)	1.524.000	0.18

Many studies have been reported that nitrogen and phosphore are the two main nutrients that can influence phytoplankton growth (Finenko and Akinnina 1974; Febregas et al 1986). Dahril, Ahmad and Iizuka, (1995 and 1998) reported that human manure and animal manures with contain high concentration of nitrogen and phosphore can support the growth and production of freshwater green algae (*Chlorella* sp) in bath culture medium. In this study, it was also found that green algae, *Chlorella* sp can growth properly in palm oil wastewater. They could also be able to decreased nitrate and phosphore in wastewater contain,. Therefore, *Chlorella* sp can be used efectively to decrease nitrogen and phosphore in wastewater of palm oil industry in Riau province. The concentration of nitrate and phosphore before and after chlorella growth in many concentration of wastewater from plam oil industry can be shown in tabel 2 follows,.

Table 2. Mean concentration of nitrate and phosphate before and after *Chlorella* cultured in each treatments.

Treatments	Nitrat (mg/l)			Phosphate (mg/l)		
	Before	After	Decreased	Before	After	Decreased
P0 (0 %)	4.1	0.4	3.7	0.40	0.09	0.31
P1 (10 %)	7.7	3.3	4.0	0.83	0.11	0.72
P2 (20 %)	13.8	2.4	11.4	1.16	0.17	0.99
P3 (30 %)	18.4	11.8	6.6	1.38	0.64	0.74

### Conclusion

Based on this study we could conclusion that waste water from Palm Oil Industri could be able to increase the growth and production of Microalgae, *Chlorella* sp.. High growth and biomass production of microalgae was founded in the concentration of 20 % of waste water with cell density of  $6.6 \times 10^6$  cell/ml and biomass, 0.36 gr/l. Utilization of *Chlorella* sp in wastewater from palm oil industry could be able to decrease the concentration of nitrate from 13.8 to 2.4, and phosphate from 1.16 to 0.17 mg/l. Therefore, *Chlorella* sp beside could be able to used as food supplement for animal husbandry, they could also eliminate water pollution by palm oil industries wastewater in Riau Province

### Acknowledgment

Thes study was supported by Ministry of Research, Technology and high education, Republic of Indonesia, Jakarta. We wish to thaks Head of Research and Society Dedication league, and Dean of Faculty of Fisheries and Marine Science, University of Riau for kindly supported this works. We also would like thank some of our students with their dedication to support this study.

### References

- Dahril, T, M. Ahmad and S. Iizuka. 1995. Effect of Human Excreta on the Growth of a Freshwater Green Alga (*Chlorella* p) and a Rotifer (*Brachionus calyciflorus*). Asian Fisheries Science 8 (1): 41-46
- Dahril, T. M. Ahmad and S Iizuka. 1998. Effect of Various Animal Manures on the Growth of a Freshwater Green Algae (*Chlorella* spp) and Rotifer (*Brachionus calyciflorus*). Asian Fisheries Dcience 11 : 193-201.



**The 7th Indonesia Japan  
Joint Scientific Symposium  
(IJJSS 2016)  
Chiba, 20-24 November 2016**

---

- Dirjen PPHP, 2006. Pedoman pengelolaan limbah industri kelapa sawit. Direktorat Pengolahan dan Pemasaran Hasil Pertanian, Deptan, Jakarta. (In Indonesia)
- Fabregas, J. Cherrero, B Cabezas and J Abaide. 1986. Biomass production and biochemical composition in mass cultures of the marine microalga *Isochrysis galbana* Porke at varying nutrient concentration. *Aquaculture* 53 : 101-113
- Finenko, ZZ and D.K.E. Akina 1974. Effect of inorganic phosphorus on the growth rate of diatom. *Marine Biology* 20:193-201
-

---

## **Ecosystem Dynamics in the Mahakam Estuary East Kalimantan**

Idris Mandang<sup>a\*</sup>, Bohari Yusuf<sup>b</sup>, Suhendar I Sachoemar<sup>c</sup>

<sup>a</sup>*Department of Physics, Faculty of Mathematics and Natural Science,  
Mulawarman University, Samarinda 75123, Indonesia*

<sup>b</sup>*Department of Chemistry, Faculty of Mathematics and Natural Science,  
Mulawarman University, Samarinda 75123, Indonesia*

<sup>c</sup>*Agency for Assessment and Applications of Technology (BPPT), Ministry of Research and  
Technology and Higher Education, Indonesia*

---

### **Abstract**

The coupled physical-biological numerical models are useful tools for understanding the relevant processes and the influence of biota and human activity on the ecological conditions in the estuary. The models, which are at the third level, should be validated, describing the most relevant parts of the natural system in a credible way in order to be applicable for making projections. The model has application to the hydrodynamics and ecosystem condition of the Mahakam Estuary, East Kalimantan, Indonesia. The work describe in the project with only a part of the component of the system, in relation to the abiotic component: hydrodynamics, suspended sediment and light, nutrient and bottom sediment. Understanding and quantitative describing of marine ecosystem requires an integration of physics, chemistry and biology. The coupling between physics, which regulates for example nutrient availability and the physical position of many organism is particularly important and thus cannot be described by biology alone. Therefore the appropriate basis for theoretical investigations of marine system are coupled models, which integrate physical, chemical and biological interactions. The numerical modelling in the well-mixed in the main channel show that tidal flows dominated the overall transport patterns and flushing through the system of the channel. Both flushing time of plan nutrient and exchange rates with the ocean play a role in governing phytoplankton blooms.

### **Keywords**

*Ecosystem dynamics; Hydrodynamics model; Ecosystem model; Suspended Sediment Transport; Mahakam estuary.*

---

## **1. Introduction**

The Mahakam Estuary, located on the east coast of Kalimantan, Indonesia, is an active delta system which has been formed in humid tropical environment under

---

\* Corresponding author. Tel.: +62-541-749140; fax: +62-541-749140.  
E-mail address: idris@fmipa.unmul.ac.id

condition of relatively large tidal amplitude, low wave-energy, and large fluvial input (**Fig.1**). Tidal processes control the sediment distribution patterns in the delta mouth and are responsible for the flaring estuarine-type inlets and numerous tidal flats. The modern Mahakam delta has two active fluvial distributary system directed northeast and southeast. The intervening areas consist of tide dominated areas, with many high sinuosity channels which are mostly not connected to the fluvial system (**Fig. 1**). This intredistributary zone occupies approximately 30% of the delta plain (Allen et al., 1977).

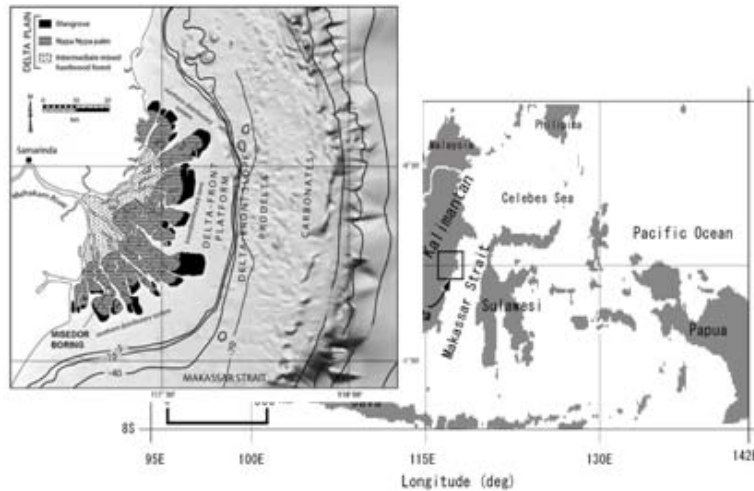

**Figure 1.** The Location of study and Bathymetric map of the Mahakam Estuary

In the Mahakam estuary, the near bottom layer salinity clearly exhibits different of salinity distribution. Due to the balance between upstream baroclinic forcing in the lower layers, the salinity front in near bottom layer does not propagate far offshore, but just in the tip of the main river channel. The front oscillates back and forth along the Mahakam river main channel in accordance with the tidal period. In the surface layer at offshore area, there is small circulation area having salinity higher than its surrounding area. This area represent the convergence and divergence zone between freshwater fluxes and tidally oscillated saline water where vertical mixing is intensively occurring in this area in coherence with tidal oscillation (Mandang, et al. , 2009).

## 2. Material and Methods

### 2.1. Observation Data

Bathymetry data of the model domain were obtained from DISHIDROS (Indonesian Navy Hydrographic Department) of Indonesian Navy (Fig. 1(b)). The model domain in this study covers the area of Mahakam delta (0o10'00"S – 1o03'00"S and 116o59'00"E – 117o49'14"E), offshore area of approximately 30 km from Muara Bayur toward the Makassar Strait and toward upstream from Muara Pegah up to Sebulu which passes through the Samarinda city (Fig. 1). The observed elevation data at Sungai Mariam (Fig. 1) with the model results for the corresponding 20 days period on July 2010 (Fig. 2)



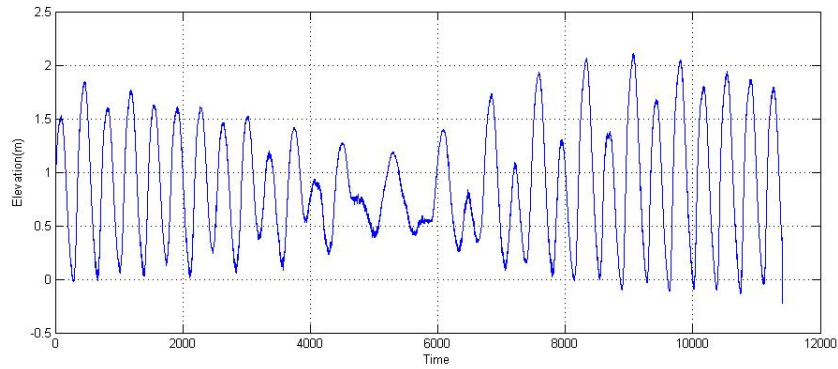

Figure 2. Elevation Data in the Sungai Mariam Mahakam Estuary

The averaged monthly river discharge data of the Mahakam river (1993 – 1998) obtained from the Research and Development Irrigation Ministry Public Work, Republic of Indonesia are shown in Fig. 3

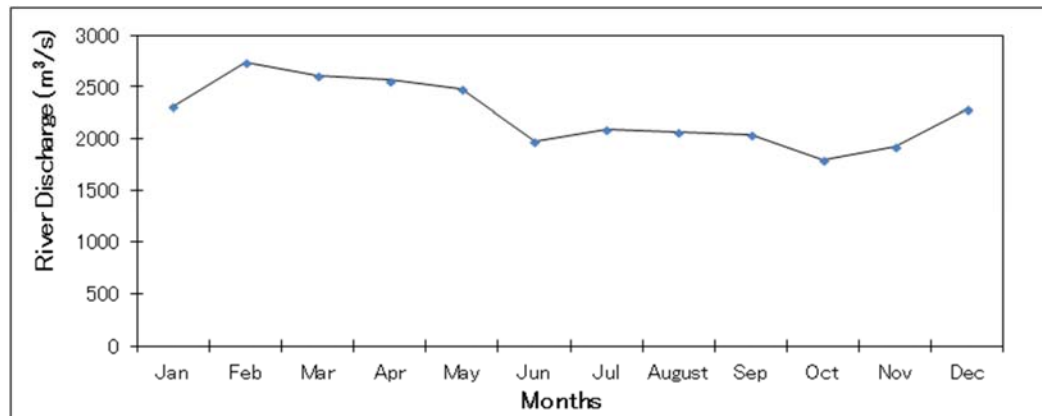

Figure 3. The average monthly river discharge data of the Mahakam river

## 2.2. Hydrodynamics Model

Estuary and Coastal Ocean Model with Sediment Transport (ECOMSED) is a three-dimensional hydrodynamic and sediment transport model. The hydrodynamic module solves the conservation of mass and momentum equations with a 2.5-level turbulent closure scheme on a curvilinear orthogonal grid in horizontal plane and  $\sigma$ -coordinate in the vertical direction. Water circulation, salinity, and temperature are obtained from the hydrodynamic module. The sediment transport module computes the sediment settling and resuspension processes for both cohesive and noncohesive sediments under the impact of waves and currents.

The governing equations of the hydrodynamic component in ECOMSED are the continuity equation, Reynold's equations, heat and salinity transport equations. The basic equations for the three-dimensional mode are:

The continuity equations:

$$\frac{\partial U}{\partial x} + \frac{\partial V}{\partial y} + \frac{\partial W}{\partial z} = 0, \quad (1)$$

where  $(U, V, W)$  are the eastward ( $x$ ), northward ( $y$ ), and upward ( $z$ ) components of the current. A dynamic boundary condition evaluated at the sea surface  $z = \eta$  will indicate the relation between sea surface elevation  $\eta$  and vertical velocity at the sea surface  $W_\eta$  as,

$$\frac{\partial \eta}{\partial t} + \frac{\partial \eta}{\partial x} U_\eta + \frac{\partial \eta}{\partial y} V_\eta = W_\eta, \quad (2)$$

The vertical velocity at the sea surface  $W_\eta$  can be obtained by integrating (1) from the bottom  $z = -H$  to the sea surface  $z = \eta$ .

The momentum equations using the Boussinesq approximations and the assumption of vertical hydrostatic equilibrium in Cartesian coordinates are given below.

$$\begin{aligned} & \frac{\partial U}{\partial t} + U \frac{\partial U}{\partial x} + V \frac{\partial U}{\partial y} + W \frac{\partial U}{\partial z} - fV \\ & = -\frac{1}{\rho_0} \frac{\partial P}{\partial x} + \frac{\partial}{\partial z} \left( A_V \frac{\partial U}{\partial z} \right) + \frac{\partial}{\partial x} \left( 2A_M \frac{\partial U}{\partial x} \right) + \frac{\partial}{\partial y} \left( A_M \left( \frac{\partial U}{\partial y} + \frac{\partial V}{\partial x} \right) \right), \end{aligned} \quad (3)$$

$$\begin{aligned} & \frac{\partial V}{\partial t} + U \frac{\partial V}{\partial x} + V \frac{\partial V}{\partial y} + W \frac{\partial V}{\partial z} + fU \\ & = -\frac{1}{\rho_0} \frac{\partial P}{\partial y} + \frac{\partial}{\partial z} \left( A_V \frac{\partial V}{\partial z} \right) + \frac{\partial}{\partial x} \left( A_M \left( \frac{\partial U}{\partial y} + \frac{\partial V}{\partial x} \right) \right) + \frac{\partial}{\partial y} \left( 2A_M \frac{\partial V}{\partial y} \right), \end{aligned} \quad (4)$$

$$P = \rho_0 g \eta + \rho_0 \int_{-z}^0 B dz, \quad (5)$$

$$B = \frac{\rho - \rho_0}{\rho_0} g, \quad (6)$$

and, the equations of temperature and salinity,

$$\frac{\partial T}{\partial t} + U \frac{\partial T}{\partial x} + V \frac{\partial T}{\partial y} + W \frac{\partial T}{\partial z} = \frac{\partial}{\partial z} \left( K_V \frac{\partial T}{\partial z} \right) + \frac{\partial}{\partial x} \left( A_H \frac{\partial T}{\partial x} \right) + \frac{\partial}{\partial y} \left( A_H \frac{\partial T}{\partial y} \right), \quad (7)$$

$$\frac{\partial S}{\partial t} + U \frac{\partial S}{\partial x} + V \frac{\partial S}{\partial y} + W \frac{\partial S}{\partial z} = \frac{\partial}{\partial z} \left( K_V \frac{\partial S}{\partial z} \right) + \frac{\partial}{\partial x} \left( A_H \frac{\partial S}{\partial x} \right) + \frac{\partial}{\partial y} \left( A_H \frac{\partial S}{\partial y} \right), \quad (8)$$

where  $T$  denotes the temperature,  $S$  the salinity,  $f$  the Coriolis parameter ( $= 2\Omega \sin \phi$ ;  $\Omega = 7.27 \times 10^{-5} \text{ s}^{-1}$  and  $\phi$  is the latitude),  $\rho$  the density,  $\rho_0$  the reference density ( $= 1024.78 \text{ kg m}^{-3}$ ),  $g$  the acceleration of gravity ( $= 9.8 \text{ m s}^{-2}$ ),  $P$  the pressure,  $B$  the buoyancy,  $A_V$  and  $K_V$  the vertical eddy viscosity and vertical diffusion coefficient,  $A_M$  the horizontal eddy viscosity,  $A_H$  the horizontal diffusion coefficient.

The horizontal eddy viscosity and diffusivity coefficient is given on the basis of Smagorinsky formula where they increase proportionally to the grid spacing and the velocity shear.

$$A_M = A_H = \alpha \Delta x \Delta y \left[ \left( \frac{\partial U}{\partial x} \right)^2 + \left( \frac{\partial V}{\partial y} + \frac{\partial U}{\partial y} \right)^2 / 2 + \left( \frac{\partial V}{\partial y} \right)^2 \right]^{1/2}, \quad (9)$$

where  $\alpha$  is a constant ( $= 0.22$ ) and  $\Delta x$  and  $\Delta y$  are horizontal mesh size ( $\Delta x = \Delta y = 200 \text{ m}$ ).

The vertical eddy diffusivity coefficients of momentum, temperature, salinity, and suspended sediment concentration are obtained through the 2.5 level turbulence closure scheme developed by Mellor and Yamada (1982).

The development of three-dimensional (3-D) hydrodynamic models started in the late 70's. Three-dimensional hydrodynamic models are numerical code solving generally the Boussinesq equations. The availability of equations based on physical laws of classic mechanics, known from 18th century, is one of the main differences between hydrodynamic and biogeochemistry models, because equations for biogeochemical phenomena are generally not universally accepted and in most cases empirical or semi-empirical.

### 2.3. Ecosystem Model

The biological model cycles concentrations of organic carbon and nitrogen through microplankton and detrital compartments with associated changes in dissolved concentrations of nitrate, ammonium and oxygen. The concentrations are updated in time by solving a transport equation for each state variable where by the biological interactions are included as source and sink terms and which takes account of vertical sinking and the physical transport by advection and diffusion. As an exception, chlorophyll is derived algebraically from microplankton carbon and nitrogen concentrations. The sediment model determines the time evolution and transport of inorganic particulate material. Exchanges between the water column and the seabed are modelled through a "fluff" layer in the microplankton and detritus compartments and in the sediment model.

The nutrient  $N_N$  and  $N_P$  ( $N_N$ ; Dissolved Inorganic Nitrogen and  $N_P$ ; Phosphate), phytoplankton  $P$ , zooplankton  $Z$  and detritus  $D$  are included in this numerical ecosystem model (Yanagi, 1999; Anukul *et al.*, 2008). The concentration of dissolved oxygen  $O_2$  is calculated at the same time. The state variables obey the following equations which include advection, diffusion and biochemical processes :

$$\begin{aligned} \frac{\partial P}{\partial t} + U \frac{\partial P}{\partial x} + V \frac{\partial P}{\partial y} + W \frac{\partial P}{\partial z} + S_P \frac{\partial P}{\partial z} &= \frac{\partial}{\partial x} \left( K_H \frac{\partial P}{\partial x} \right) + \frac{\partial}{\partial z} \left( K_V \frac{\partial P}{\partial z} \right) \\ &+ A_1 P - A_2 P - A_3 Z, \end{aligned} \quad (10)$$

$$\begin{aligned} \frac{\partial Z}{\partial t} + U \frac{\partial Z}{\partial x} + V \frac{\partial Z}{\partial y} + W \frac{\partial Z}{\partial z} &= \frac{\partial}{\partial x} \left( K_H \frac{\partial Z}{\partial x} \right) + \frac{\partial}{\partial z} \left( K_V \frac{\partial Z}{\partial z} \right) \\ &+ A_3 Z - A_4 Z - A_5 Z - A_6 Z, \end{aligned} \quad (11)$$

$$\begin{aligned} \frac{\partial N_N}{\partial t} + U \frac{\partial N_N}{\partial x} + V \frac{\partial N_N}{\partial y} + W \frac{\partial N_N}{\partial z} &= \frac{\partial}{\partial x} \left( K_H \frac{\partial N_N}{\partial x} \right) + \frac{\partial}{\partial z} \left( K_V \frac{\partial N_N}{\partial z} \right) \\ &- A_1 Z + A_6 Z + A_7 Z, \end{aligned} \quad (12)$$

$$\begin{aligned} \frac{\partial N_P}{\partial t} + U \frac{\partial N_P}{\partial x} + W \frac{\partial N_P}{\partial z} &= \frac{\partial}{\partial x} \left( K_H \frac{\partial N_P}{\partial x} \right) + \frac{\partial}{\partial z} \left( K_V \frac{\partial N_P}{\partial z} \right) \\ &- A_1 P + A_6 P + A_7 D, \end{aligned} \quad (13)$$

$$\begin{aligned} \frac{\partial D}{\partial t} + U \frac{\partial D}{\partial x} + W \frac{\partial D}{\partial z} + S_D \frac{\partial D}{\partial z} &= \frac{\partial}{\partial x} \left( K_H \frac{\partial D}{\partial x} \right) + \frac{\partial}{\partial z} \left( K_V \frac{\partial D}{\partial z} \right) \\ &- A_2 P + A_4 P + A_5 D - A_7 D, \end{aligned} \quad (14)$$

$$\frac{\partial O_2}{\partial t} + U \frac{\partial O_2}{\partial x} + W \frac{\partial O_2}{\partial z} = \frac{\partial}{\partial x} \left( K_H \frac{\partial O_2}{\partial x} \right) + \frac{\partial}{\partial z} \left( K_V \frac{\partial O_2}{\partial z} \right) + B_1 P - B_2 P - B_3 P - B_4 P. \quad (15)$$

The origin of the Cartesian coordinate system is set at the sea surface of the estuary head with the x - axis directed toward the estuary mouth and the z-axis upward. U and W denote the velocity in the x and z directions, respectively. Sp denotes the sinking speed of phytoplankton and SD that of detritus.  $K_H$  and  $K_V$  denote the horizontal and vertical diffusivities, which depend on the tidal current Amplitude and the Richardson number.

The computational domain, grid spacing and time steps were the same as those of ECOMSED the same as those of temperature and salinity with fixed values at all grid locations along the boundary plane throughout model operation. The loads of major rivers were taken into consideration, while non-point source nutrients along coastlines were ignored due to a lack of reliable data. Initial values of ecosystem parameters, derived from the overall average of measured data, were set to be identical in all experiments  $-1.55 \text{ mg m}^{-3}$ ,  $9.70 \text{ } \mu\text{M-N l}^{-1}$  and  $0.23 \text{ } \mu\text{M-P l}^{-1}$  for chl-a, DIN and DIP, respectively. Zooplankton and detritus were assigned as 8.2 % of chl-a and equal to chl-a concentrations, respectively, similar to the lateral boundary setting.

The model operation was tested and a steady state of all simulated parameters was attained after days 5 of computation. Calculated results were collected and averaged from days 15 to 20 in the same way as those of circulation model. Simulated chl-a distributions in the same months of observational cruises are presented and discussed.

### 3. Results and Discussion

Simulations of the spatial and temporal variations in chlorophyll-u, nitrate, phosphate and suspended particulate matter distributions in winter, spring and summer show how the development of the spring bloom and subsequent maintenance of primary production is controlled by the physicochemical environment of the plume zone. Results are also shown for two stations, one characterized by the high nutrient and suspended matter concentrations of the plume and the other by the relatively low nutrient and sediment concentrations of the offshore waters. The modelled net primary production at the plume site was  $105 \text{ g C m}^{-2} \text{ a}^{-1}$  and  $127 \text{ g C m}^{-2} \text{ a}^{-1}$  offshore. Primary production was controlled by light limitation between October and March and by the availability of nutrients during the rest of the year. The phytoplankton nutrient demand is met by in-situ recycling processes during the summer. The likely effect of increasing and decreasing anthropogenic riverine inputs of nitrate and phosphate upon ecosystem function was also investigated. Modelling experiments indicate that increasing the nitrogen to silicate ratio in freshwater inputs increased the production of non-siliceous phytoplankton in the plume.

The results of this model have been used to calculate the annual and quarterly mass balances describing the usage of inorganic nitrogen, phosphate and silicate within the plume zone. The modelled Mahakam Estuary retains 3.9% of the freshwater dissolved inorganic nitrogen, 2.2% of the freshwater phosphate and 1.3% of the freshwater silicate input over the simulated seasonal cycle. The remainder is transported into the Makassar Strait in either dissolved or particulate form. The reliability of these results is discussed.

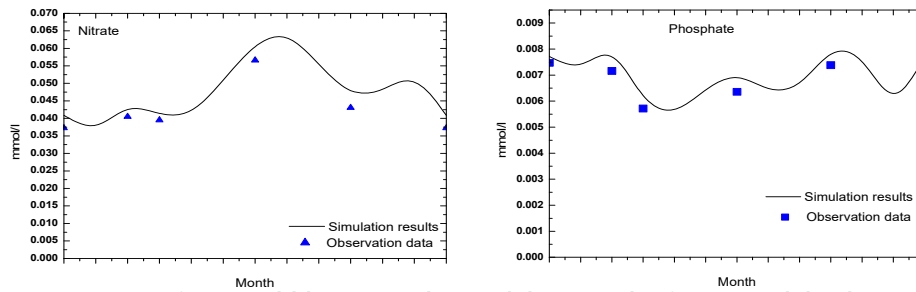

**Figure 4.** Verification model between simulation and observation data for nitrate and phosphate

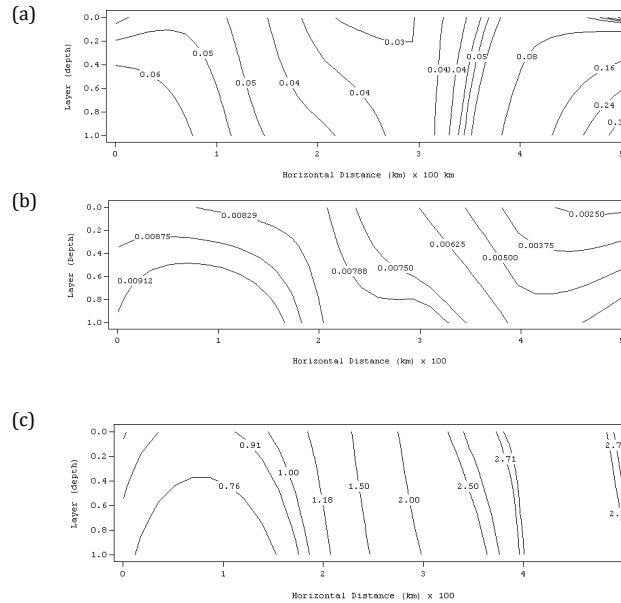

**Figure 5.** Distribution pattern (a) DIP, (b) DIN, and (c) Chl-a in the Mahakam Estuary.

### Acknowledgement

The author would like to thank The Ministry of Research, Technology, and Higher Education Republic of Indonesia and for financial support.

### References

- Buranaprat, B, Yanagi, T, Niemann, K, Matsumura, K, and Sojisporn, P. (2008). Surface chlorophyll-a dynamics in the upper Gulf of Thailand revealed by a coupled hydrodynamic-ecosystem model. *Journal of Oceanography*, Vol.64, pp. 639 - 656.
- Allen, G.P., and Chambers, J.L.C. (1998). Sedimentation in the Modern and Miocene Mahakam delta, Jakarta, Indonesia Petroleum Association, Field Trip Guidebook.
- Andreas, M, and Gunther, R (2003). Reviewe of three-dimensional ecological modelling related to the North Sea shelf system: Part 1 : models and their results. *Progress in Oceanography*, Vol. 57, pp 175 - 217.
- Blumberg, A.F., and G. L. Mellor. (1987) A description of a three-dimensional coastal ocean model”, In: *Coastal and Estuarine Sciences 4, Three-Dimensional Coastal Ocean Models*”, Amer Geophys. Union, Washington D.C., 1 – 20.

Mandang, I., and Yanagi, T. (2009). Cohesive Sediment Transport in the 3D hydrodynamic-baroclinic circulation model in the Mahakam Estuary, East Kalimantan, Indonesia, Coastal Marine Science, Vol. 33, No. 1, pp 9 – 21.

Yanagi, T. (199). Coastal Oceanography, Terra Scientific Publishing Company, Tokyo

---

## **Aquarius Sea Surface Salinity in the Indonesian Seas**

I Wayan Gede Astawa Karang<sup>a,b\*</sup>, Bayu Priyono<sup>c</sup>, Made Narayana Adibusana<sup>a</sup>,  
Takahiro Osawa<sup>b</sup>

<sup>a</sup>*Faculty of Marine Science and Fisheries, University of Udayana, Denpasar, Bali, Indonesia*

<sup>b</sup>*Center for Remote Sensing and Ocean Sciences (CReSOS), University of Udayana,  
Denpasar, Bali, Indonesia*

<sup>c</sup>*Marine Research and Observation, Jl. Baru Perancak, Negara-Jembrana, Bali*

---

### **Abstract**

National Aeronautics and Space Administration (NASA) recently launched Aquarius satellite to measure the Sea Surface Salinity (SSS) fields from space at global and regional scales. These five years of SSS data were analyzed in the Indonesian Seas. The analysis is focused on what patterns of the spatial and temporal distributions of SSS in the Indonesian Seas? How does SSS change with seasons in the Indonesian Seas, particularly in the Indonesian Throughflow (ITF) channel?

As a result Aquarius observations of SSS showed Indonesian Sea varied annual and seasonally. SSS propagating feature was characterized with the seasonal cycle such as Southeast monsoon and Northwest monsoon and estimated SSS concentrations during January to May give fresher (lower) than during June to November due to rainfall effects.

The seasonal variability of SSS in the ITF channel was also estimated in the Java Sea, Makassar Strait, Celebes and Banda Seas. These results showed that SSS patterns in these seas might be influenced by El-Nino- Southern Oscillation (ENSO) phenomena and La-Nina during Northwest Monsoon period which indicated by remarkable freshening in the South China Sea then expand to the Java Sea, Makassar Strait and Banda Sea.

### **Keywords**

*Aquarius; Sea Surface Salinity (SSS); Indonesian Seas; ITF; Seasonal Variability; ENSO-Monsoon*

---

## **1. Introduction**

The global scale observations of oceanic and climate variables will be answered how is the ocean-atmosphere interaction process occurred and its relationship with the climate change. The space observations of oceanic variables are starting in the sixties with sea surface temperatures (SST) followed by ocean color in the eighties and the surface wind field in the nineties (Menezes et al., 2014). The availability of satellite oceanography data has given great benefit in the last six decades not only for physical processes but also in term of biology and ecosystem of the ocean. However, one important variable that is still not well understood, due to the lack of routine global observations, is salinity [e.g., Roemmich and Gilson, 2009; Locarnini et al., 2010; Antonov et al., 2010., Menezes et al., 2014]. Compared to SST and ocean colour measurements, salinity observations are

---

\* Corresponding author. Tel.: +62361-702802  
E-mail address: gedekarang@unud.ac.id

sparse both temporally and spatially especially in the tropical oceans. Together with temperature, salinity variations have a major influence on the density of seawater and, therefore, the oceanic circulation.

In the recent past, the technological advances have significantly improved the basis of salinity measurements, and gives oceanographers more possibility to investigate contemporary salinity variations for spatial and temporal purposes. The advancement in observing ocean salinity is the launch of two satellite missions designed to retrieve sea surface salinity (SSS) from spaceborne measurements (Kohler et al., 2015). The first mission is the European Space Agency's (ESA) SMOS ("Soil Moisture and Ocean Salinity", Font et al. (2004)), which started retrieving SSS in November 2009, followed by the American National Aeronautical Space Agency's (NASA) "Aquarius/SAC-D" (Satellite de Aplicaciones Cientificas) mission (Lagerloef et al., 2008) two years later. The latter ended on June 7, 2015 due to an unrecoverable hardware failure. SMOS SSS data are now available on a routine basis, covering the global ocean every 3 days. Aquarius covered the global ocean every 7 days and SSS data are available until June 2015. Significant benefits can be expected from these novel satellite SSS fields for quantitative studies of ocean salinity variations.

Recently several study of oceanic and atmospheric process related to the SSS using Aquarius satellite data archive have been done. Lee et al (2012) investigated such the tropical instability waves in the equatorial Pacific and Atlantic oceans using Aquarius data set. Gierach et al (2013) used Aquarius to study the extreme Mississippi river flooding event in the Gulf of Mexico in May–July 2011. The used of Aquarius data were extend for the salinity changes study in the Amazon/Orinoco [Grotsky et al., 2014] and South Indian Ocean: Revealing annual-period planetary waves (Menezes et al., 2014). Most of these studies focus on the Atlantic and Indian Oceans and to the best of our knowledge none has been dedicated to the Indonesian Seas.

The Indonesian Seas plays a central role in the climate system. They carried out the Pacific waters in to Indian Ocean through the Indonesian Throughflow (ITF) (Sprintall et al., 2003). The surface layer of the Indonesian Seas is well known controlled by winds with a strong annual signal driven by seasonally reversing monsoon. The aims of present study is to compare SSS annual mean and to observe SSS variability in the Indonesian Seas.

## 2. Research methods

The study area extends from 91,5° E – 142,5° E and 15,5°S – 15,5° N (Figure 1). In this study, monthly as well as 7-day smoothed fields at 1°x 1° from January 2012 to December 2014 were used. The Level-3 product used and their metadata were obtained from Physical Oceanography Distributed Active Archive Center, <ftp://podaac-ftp.jpl.nasa.gov/allData/aquarius/L3/mapped/CAPv4/>). Aquarius flies in a sun-synchronous polar orbit and crosses the equator at 6am (descending) and 6pm (ascending) local time. Aquarius directly retrieves brightness temperatures in approximately 390 km wide swaths with a global coverage of ice-free ocean every 7 days from an altitude of 657km and an inclination of 98°. The Aquarius instrument consists of three L-band horn antennas sharing a common parabolic reflector. Each horn antenna connects to a separate Dicke radiometer, and the scatterometer is time-shared sequentially between the three horns, which means that the scatterometer signal is rotated among the three horns and through vertical and horizontal polarization channels. In the present study we calculate the annual and monthly mean SSS for the Indonesian Seas and find the differences. Compute seasonal anomalies of the SSS by removing the annual mean. Calculate the seasonal SSS anomaly for a few different locations in the Indonesian Seas as a part of ITF area (South China Sea, Java Sea, Banda Sea, Makassar Strait, Selebes Sea, Western Pacific and South-east Indian Ocean) as



shown in the Figure 1. Spatial analysis is carry out by using *System for Automated Geoscientific Analyses (SAGA)* and *Quantum Geographic Information System (QGIS)*.

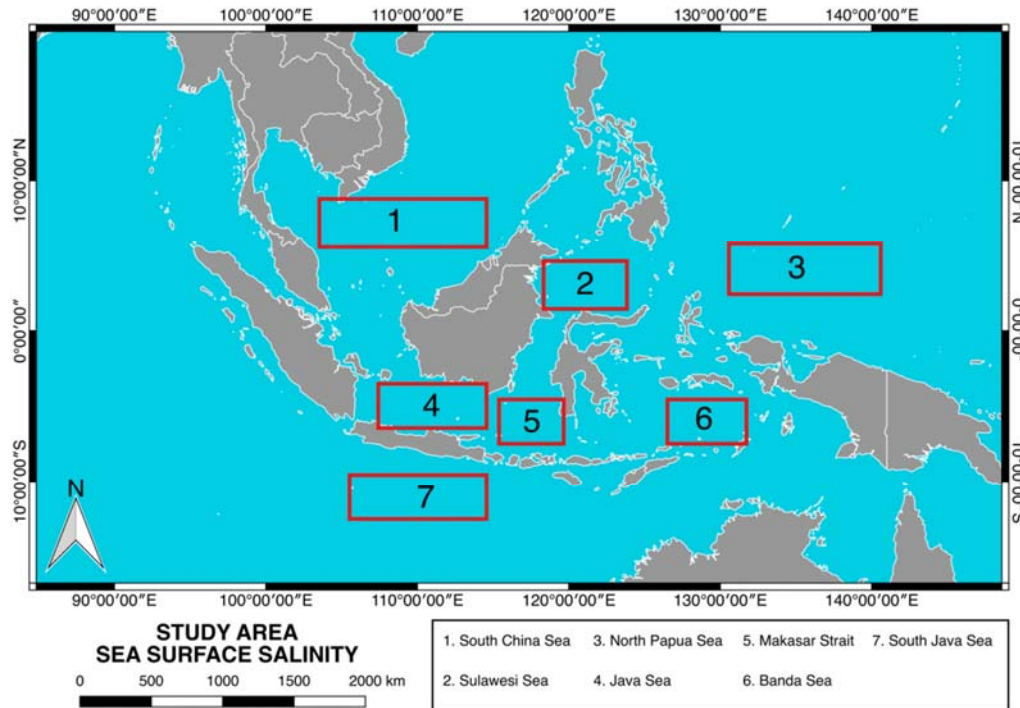

**Figure 1.** Study area; location of gridded Aquarius data set used in this study.

### 3. Results and discussion

#### 3.1 Monthly average SSS distribution in the Indonesian Seas.

Figure 2 and 3 shows the monthly mean of four years SSS in the Indonesian Seas. Based on monthly mean SSS data, the maximum SSS occurred in Southeast monsoon (July to September) and the minimum SSS occurred in Northwest monsoon (January to April). The occurrence of spatial variability of SSS in the Indonesian Seas are indicated by low SSS in the eastern part of inland seas (Karimata Strait and Java Sea) compare to the western part area. This result indicate that the fresh water flow South China Sea lead to lower SSS in the Karimata Strait and Java Sea. SSS of September and October has a highest range in spatially with reaching 14 ppt and 13 ppt, respectively.

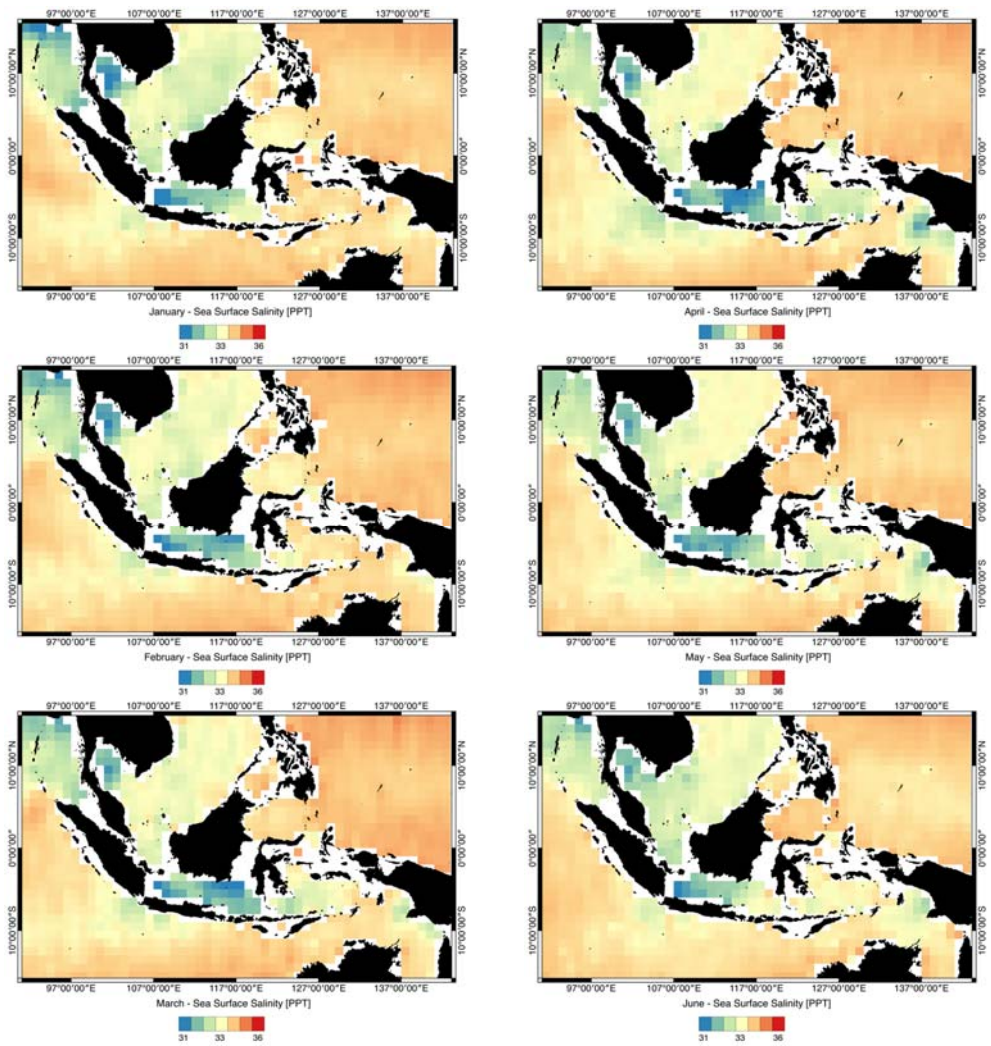

Figure 2. Monthly average of SSS derived from Aquarius; January to June

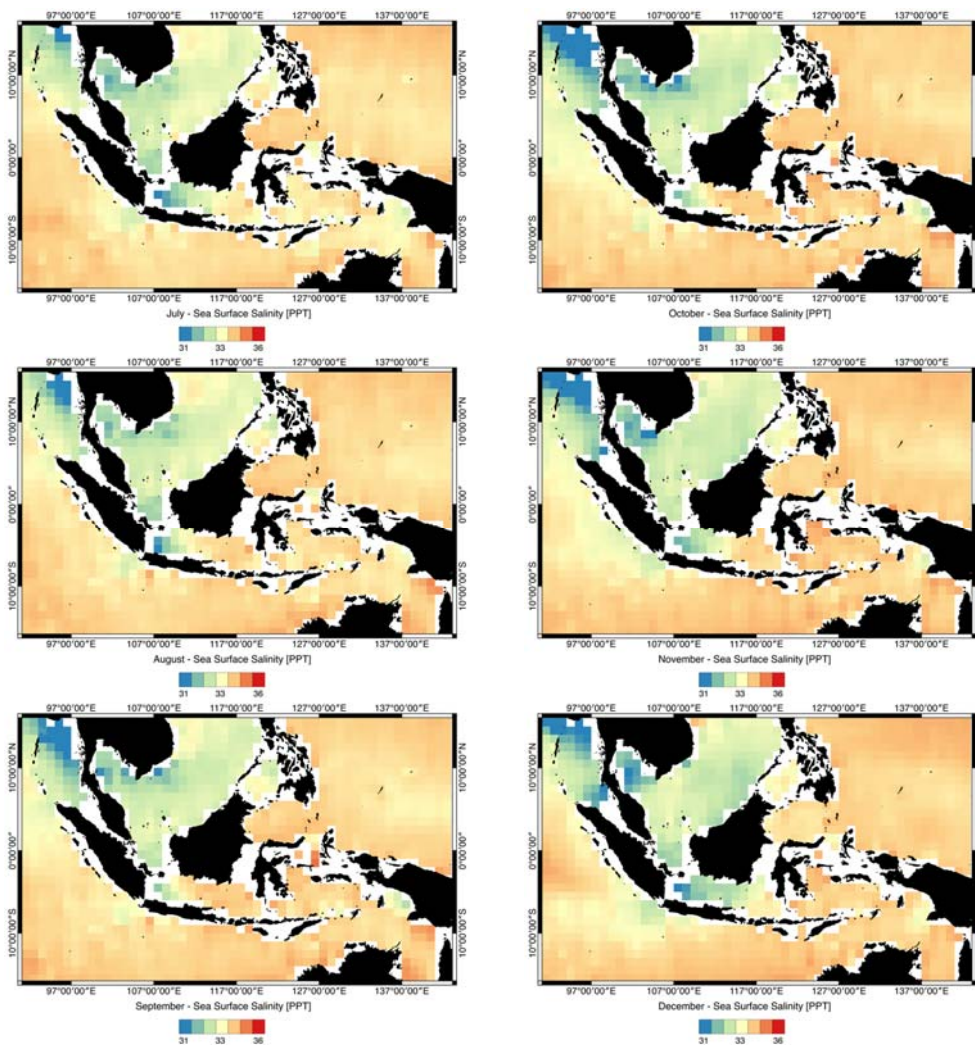

Figure 3. Monthly average of SSS derived from Aquarius; July to December

### 3.2. Annual Difference

The annual variation of SSS data in the region is shown in SSS difference from year 2012 to 2014 (Figure 4). The results showed Aquarius SSS in 2013 is lower than 2012 and 2014. The 2013 SSS shows the fresh water in the most part of Indonesian water (Karimata Strait, Makasar Strait, Java, Flores and Banda Seas), except Celebes Sea. The Java Sea SSS in 2013 is 0.3 - 1 lower than 2012. The Banda Sea SSS difference of 2013-2012 is 0.3 - 0.6. The saline water in Celebes Sea is recognized in 2013 compare to other area in the inland seas.

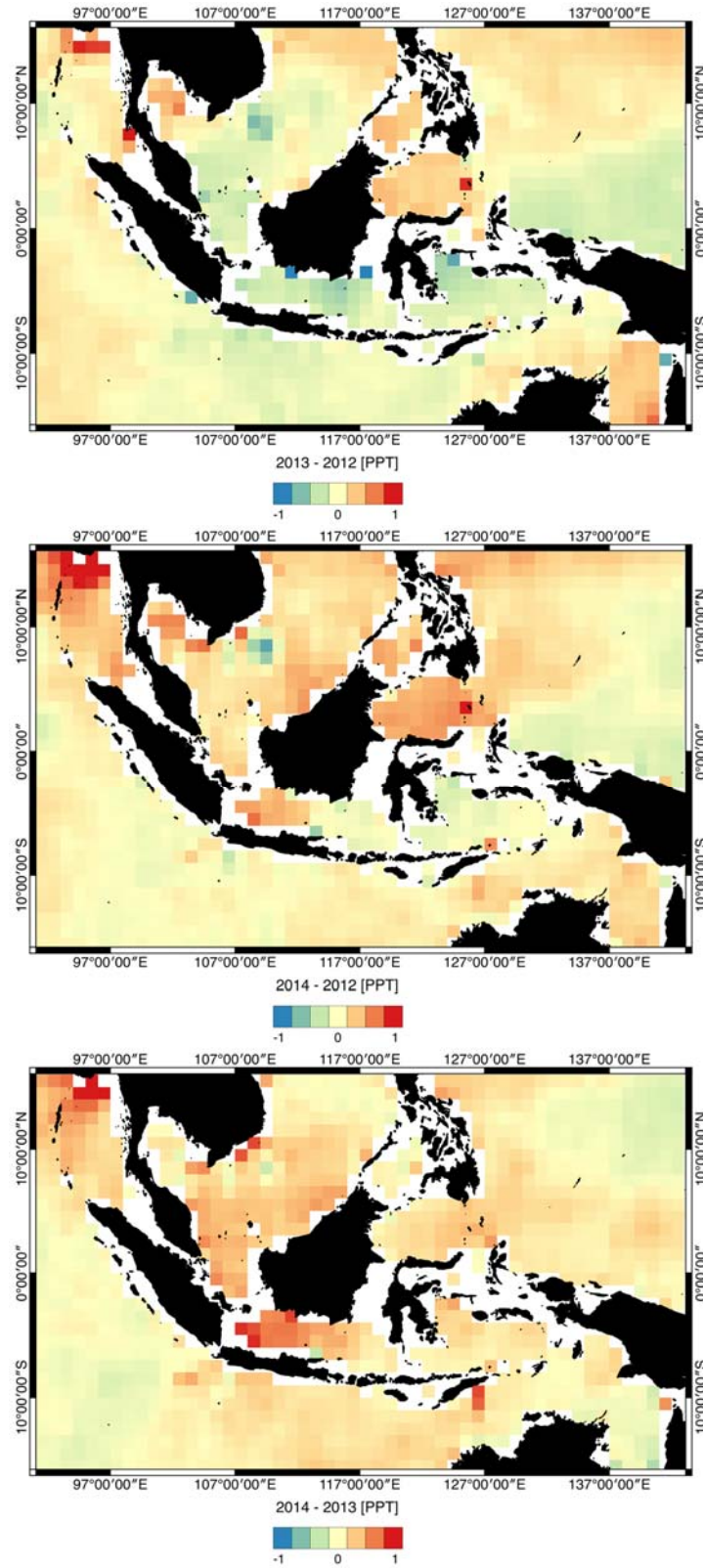

Figure 4. Annual difference of SSS (2013-2012; 2014-2012; 2014-2013)

### 3.3. Seasonal SSS anomaly

The Aquarius SSS anomaly pattern for the northwest monsoon December-January-February (DJF) and second transition March-April-May (MAM) seasons, averaged from 2012 to 2014 is shown in Figure 4a and Figure 4.b. Besides the SSS for Aquarius for the different season; southeast monsoon June-July-August (JJA) and first transition September-October-November (SON). DJF anomaly shows a very clear remarkable freshening in Java and Celebes Seas. A clear westward propagation of low salinity water from Java Sea into Banda Sea can be seen in the MAM SSS field. The freshen forms a low salinity also can be seen in Arafura Self.

The spatial distribution for the transition period (MAM) reveals some significant change in SSS distribution. The pattern shows great range, from a low of -1 in the Java, Flores and Banda Seas to 0.8 in the South China Sea, in contrast to only a 0 - 1 for the SON.

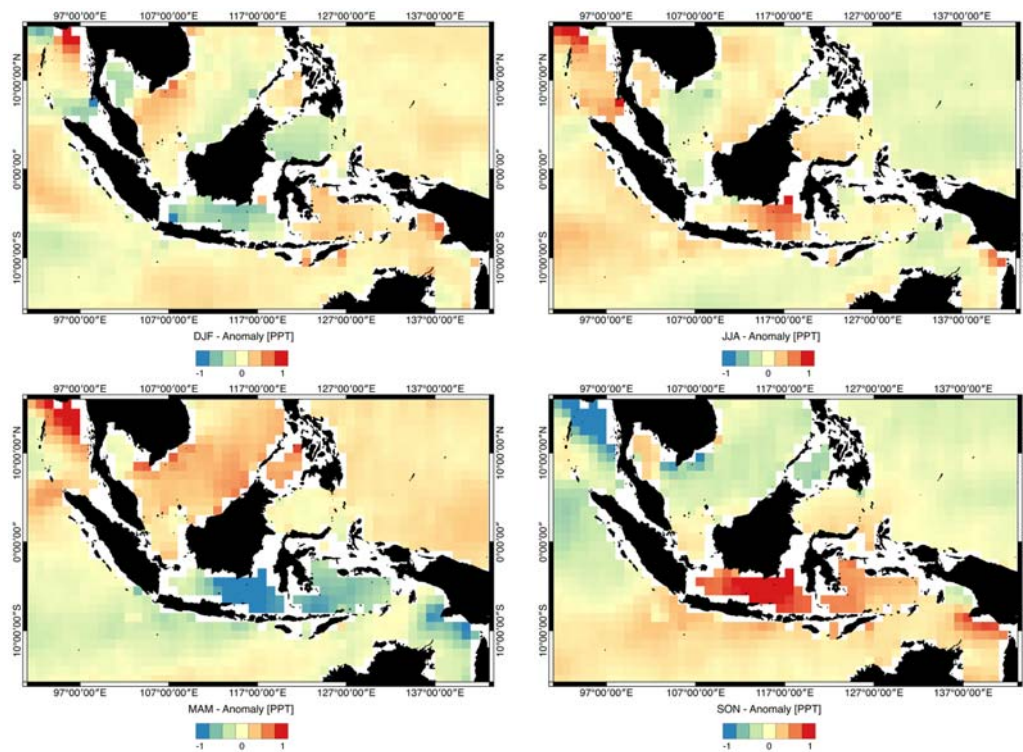

Figure 5. Seasonal anomaly of SSS

### 3.4 Time-latitude diagram of Aquarius SSS in the ITF region

The transfer of water mass between the Pacific and the Indian Oceans is an important phenomenon for regional ocean-atmospheric circulation in the Indonesian Seas with potential impacts on the monsoon phenomena and ENSO (Webster et al., 1998). Figure 6 displays the SSS variability of Celebes Sea, Makasar Strait, Banda and Java Seas. During the south east monsoon the Celebes Sea SSS is above 34. The lowest SSS is observed during the northwest monsoon and mostly from February to April. In the Makasar Strait during the south east monsoon the SSS varies between 30.5 and 34, fresher than the Celebes Sea. During the north west monsoon in the Banda Sea SSS during the south east monsoon the SSS is between 34 and 34.5.

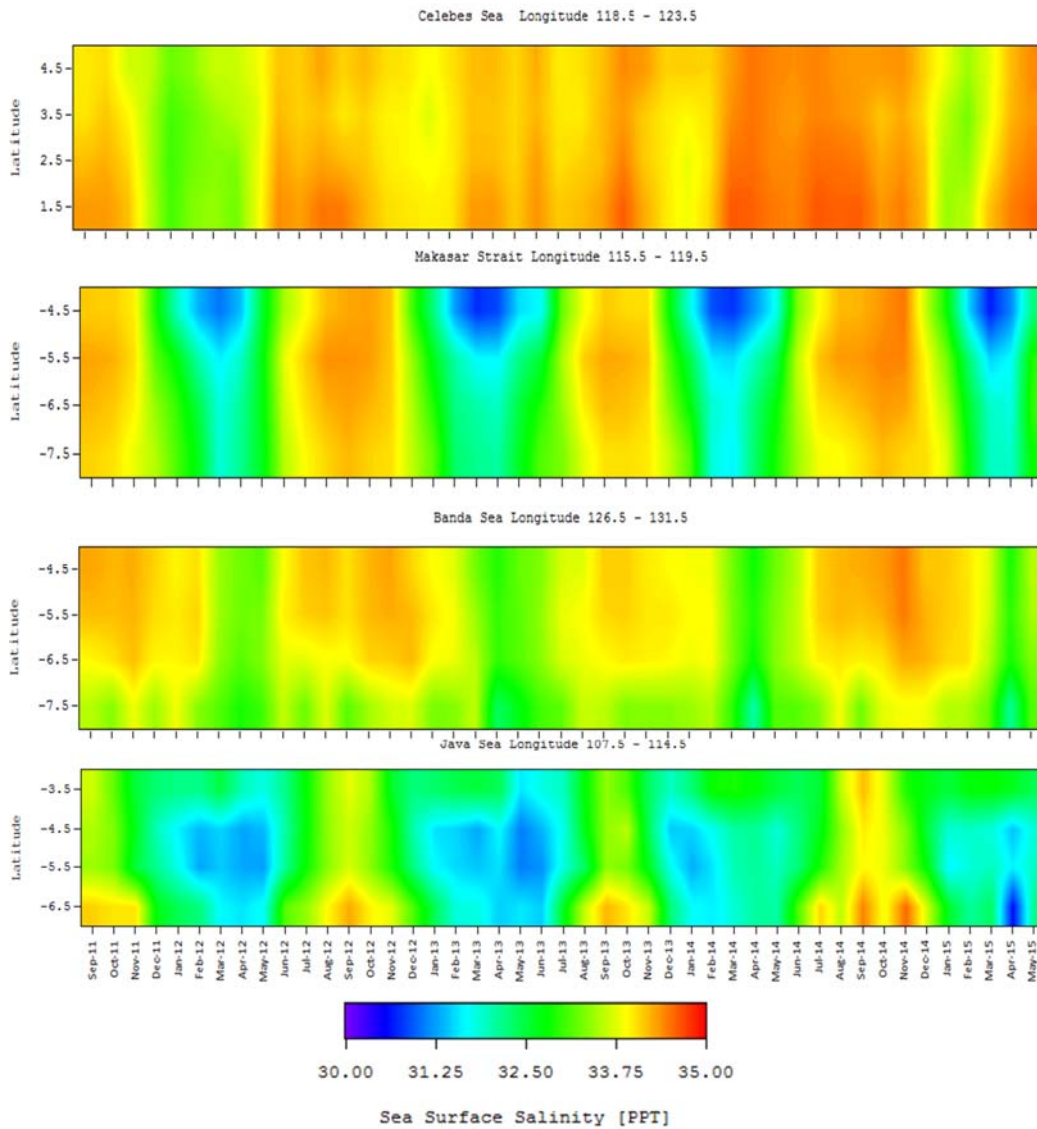

Figure 6. Aquarius SSS of ITF channels (Celebes Sea, Makasar Strait, Banda Sea and Java Sea)

### 3.5 Time-latitude diagram of Aquarius SSS in the outland-sea

SSS variation of ITF inflow (South China Sea; West Pacific) and outflow (South Java Sea) area are shown in Figure 7. The West Pacific SSS shows very clear monsoonal features. The South China Sea SSS do not show very clear monsoonal variation in contrast of SSS in West Pacific and South Java Sea show. Compare to West Pacific and South Java Sea, the South China Sea has the lowest SSS. It is seem to be freshening in the South China Sea occurred for all season. In the West Pacific during north west monsoon (December to May) the SSS varies between 34 and 35. In the South Java Sea, during transition period (September to November) the SSS varies between 34 and 34.3.

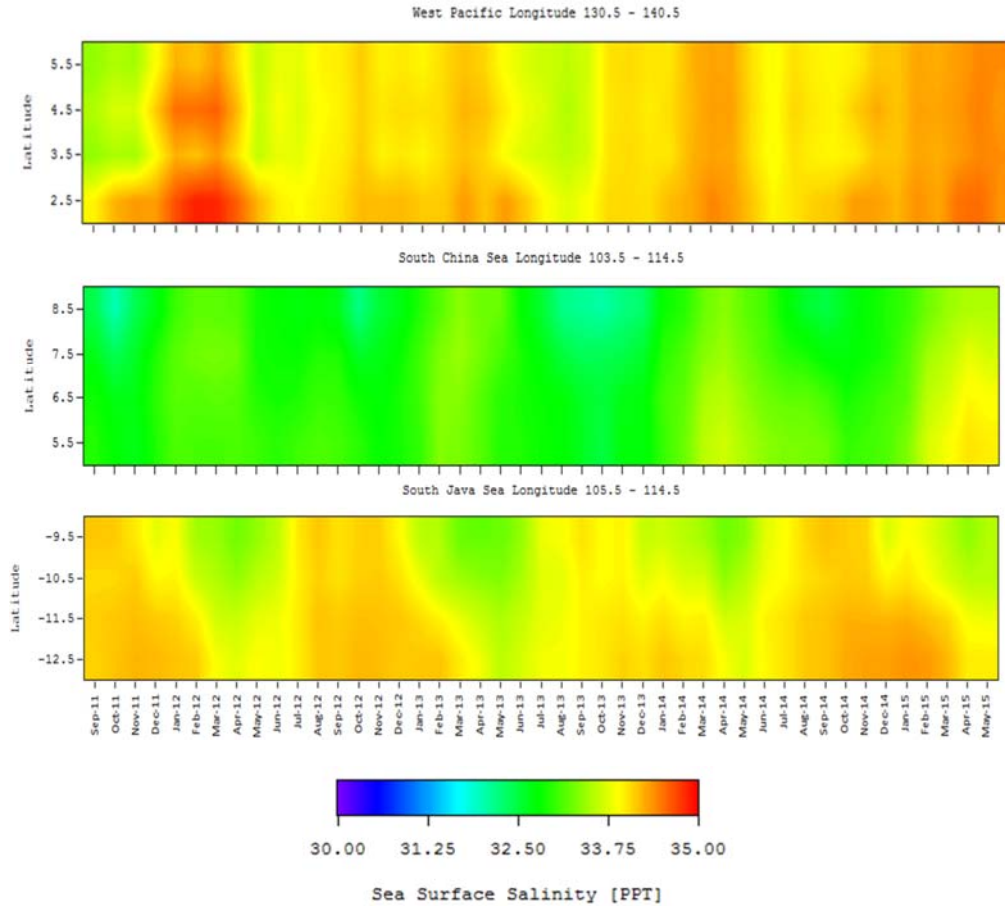

Figure 7. Aquarius SSS of outland-seas (West Pacific, South China Sea, South Java Sea)

### 3. Conclusion

The seasonal and spatial variability of SSS in the Indonesian Seas were determined. Aquarius displays an annual and seasonal cycle for the Indonesian Seas. Aquarius SSS feature was characterized with the seasonal cycle such as Southeast monsoon and Northwest monsoon and estimated SSS concentrations during January to May give fresher (lower) than during June to November due to rainfall effects.

The seasonal variability of SSS in the ITF channels was also estimated in the Java Sea, Makassar Strait, Banda and Celebes Seas. As a major transport of ITF, these areas show very clear seasonal patterns which are also influenced by monsoons. These results showed that SSS patterns in these seas might be influenced by El-Niño-Southern Oscillation (ENSO) phenomena and La-Niña during Northwest Monsoon period, which is indicated by remarkable freshening in the South China Sea that then expands to the Java Sea, Makassar Strait, and Banda Sea.

## Acknowledgments

I would like to thank the institution that provided the data used in this study: The Aquarius satellite SSS data were supplied through the NASA/CONAE Aquarius/SACD Project and can be downloaded from <http://podaac.jpl.nasa.gov>. I would like to thank the CReSOS, University of Udayana that support this study.

## References

- Antonov, J. I., D. Seidov, T. P. Boyer, R. A. Locarnini, A. V. Mishonov, H. E. Garcia, O. K. Baranova, M. M. Zweng, and D. R. Johnson (2010), World Ocean Atlas 2009, Volume 2: Salinity, in NOAA Atlas NESDIS 69, edited by S. Levitus, 184 pp., U.S. Gov. Print. Off., Washington, D. C.
- Font, J., G. S. E. Lagerloef, D. L. Vine, A. Camps, and O. Zanife (2004), The determination of surface salinity with the European SMOS space mission, *IEEE T. Geosci. Remote*, 42, 2196–2205.
- Gierach, M. M., J. Vazquez-Cuervo, T. Lee, and V. M. Tsontos (2013), Aquarius and SMOS detect effects of an extreme Mississippi river flooding event in the Gulf of Mexico, *Geophys. Res. Lett.*, 40, 5188–5193, doi:10.1002/grl.50995.
- Grodsky, S. A., G. Reverdin, J. A. Carton, and V. J. Coles (2014), Year-to-year salinity changes in the Amazon plume: Contrasting 2011 and 2012 Aquarius/SACD and SMOS satellite datas, *Remote Sens. Environ.*, 140, 14–22, doi:10.1016/j.rse.2013.08.033.
- Kohler, J., M. S. Martins, N. Sierra, and D. Stammer (2015), Quality assessment of spaceborne sea surface salinity observations over the northern North Atlantic, *Journal of Geophysical Research*, 120 (1), 94–112.
- Lagerloef, G., et al. (2008), The Aquarius/SAC-D Mission: Designed to meet the salinity remote-sensing challenge, *Oceanography*, 21(1), 68–81.
- Lee, T., G. Lagerloef, H.-Y. Gierach, M. M. and Kao, S. Yueh, and K. Dohan (2012), Aquarius reveals salinity structure of tropical instability waves, *Geophys. Res. Lett.*, 39, L12610, doi:10.1029/2012GL052232.
- Locarnini, R. A., A. V. Mishonov, J. I. Antonov, T. P. Boyer, H. E. Garcia, O. K. Baranova, M. M. Zweng, and D. R. Johnson (2010), World Ocean Atlas 2009, Volume 1: Temperature, in NOAA Atlas NESDIS 68, edited by S. Levitus, 184 pp., U.S. Gov. Print. Off., Washington, D. C.
- Menezes, V. V., M. L. Vianna, and H. E. Phillips (2014), Aquarius sea surface salinity in the South Indian Ocean: Revealing annual-period planetary waves, *J. Geophys. Res. Oceans*, 119, 3883–3908, doi:10.1002/2014JC009935.
- Roemmich, D., and J. Gilson (2009), The 2004–2008 mean and annual cycle of temperature, salinity, and steric height in the global ocean from the Argo program, *Prog. Oceanogr.*, 82(2), 81–100, doi:10.1016/j.pocean.2009.03.004.
- Sprintall, J., J. T. Potemra, S. L. Hautala, N. A. Bray, and W. W. Pandoe (2003), Temperature and salinity variability in the exit passages of the Indonesian Throughflow, *Deep Sea Res., Part II*, 50, 2183–2204, doi:10.1016/s0967-0645(03)00052-3.
- Webster, P., V. Magana, T. Palmer, J. Shukla, R. Tomas, M. Yanai, and T. Yasunari (1998), Monsoons: processes, predictability, and the prospects for prediction, *Journal of Geophysical Research* 103, 14,451–14,510.



**Coastal Dynamic, Nitrate ( $\text{NO}_3^-$ ) Phosphate ( $\text{PO}_4^-$ ) and  
Phytoplankton Abundance at Morodemak North Java Sea  
Indonesia**

**<sup>a</sup>Muh. Yusuf**

<sup>a</sup>Marine Science Department, Faculty of Fisheries and Marine Sciences,  
Diponegoro University, Prof. Sudarto, SH Street, Tembalang, Semarang. 50275. Central  
Java & University of Bangka Belitung - Indonesia.

---

**Abstract**

Coastal dynamic of North Java sea was the influence of the west and east monsoon as well as interseasonal effect during April-June and October-December. Especially to coastal current pattern and to nitrate and phosphate variation and ultimately to phytoplankton. Study area focused at  $110^\circ 52' 03.72'' \text{E}$  -  $110^\circ 54' 68'' \text{E}$  and  $06^\circ 80.4' 75'' \text{S}$  -  $06^\circ 82' 72.22'' \text{S}$ . Aim of study was to built current spatial model, measure insitu nitrate and phosphate variation and phytoplankton abundance. Coastal current spatial modelling was done using SMS-v8.1 and sampling site based to purposive sampling representative to the estuary and coastal system. Spatial modelling using Arc.GIS 10 software. The study revealed that nitrate concentration ranged at 0.60-2.0 mg/l, phosphate 0.04-0.24 mg/l and current speed 0.0003-0.0033 m/sec to southeast direction. About 22 genera of phytoplankton were found, with moderate dominancy of Bacillariophyceae, Dinophyceae and most dominance of Rhizosolenia. Most abundance of phytoplankton was at the mouth of the river or the estuary with 28,090,000 cell/ $\text{m}^3$ . Lowest abundance at offshore coastal site with 17,060,000 cell/ $\text{m}^3$ . The highest diversity index (H') was 1.606 at the estuary and the lowest was 0.8730 at coastal offshore.

**Keywords**

Coastal current, nitrate, phosphate, phytoplankton, North-java sea

---

**1. Introduction**

Coastal water regarded as specific ecosystem with many natural and man made influences from upland areas as well from oceans (Dahuri *et.al*, 2004). Nutrient of phosphate and nitrogen considered as the limiting factor for seawater productivity (Sastrawijaya, 2009). The two nutrients has important role for the life of marine organisms such as phytoplankton (Fachrul *et.al*. 2005). Nitrogen compound which can be used are nitrite and nitrate, while phosphorus in the form of ortho phosphat (Jones-Lee and Lee, 2005).

Semarang, Morodemak and Demak coastal water the main study area was in fact as fishing gound, auction place and fishermen villages with many kinds of polution to the

adjacent water and effect to water quality. More specifically are house hold organic sewage and detergent, which will affect the concentration of nitrate and phosphate in the seawater. Coastal current will have the influence to the distribution of nitrate, phosphate and phytoplankton. Aim of study was to measure insitu nitrate, phosphate variation and phytoplankton abundance, coastal current and built spatial model.

## 2. Method

Primary data of nitrate, phosphate phytoplankton abundance as well as dissolved oxygen (DO), pH, salinity, sea surface temperature (SST) and water transparency. Supporting data are digital map of Semarang and Demak coastal water in a scale of 1 : 250,000. Sampling coordinates were based on Purposive Sampling Method as referred to the aim of the research (Sudjana, 1996) using GPS (*Global Positioning System*). Total of 12 station were sampled, where station-1 represent for river mouth estuary. Station 2, 3, 4, and 5 represent for the coastal water and station 6, 7, 8 and 9 represent as the fishing ground and station 10, 11, and 12 more offshore water. Precisely in the coordinate of 110°52'03.72"E - 110°54'68"E and 06°80.4'75"S - 06°82'72.22"S. Seawater samples were taken with volume of 500 ml and immediately store in a cool box. Seawater quality parameters such as dissolved oxygen, temperature, pH, salinity and transparency were measured insitu. Phytoplankton were sampled using 0.25 micron mesh plankton net and preserve in 4 % formaline. Coastal current measured using current meter.

Nitrate measurement in the laboratory using Spectrophotometer after filtered with 1 $\mu$ m mesh, while absorbance reading using 220nm and 275nm wavelength of standard metode SNI 06-688.31-2005. Phosphate measurement using standard SNI 06-2480-1991. Field data and coordinate were the processed into spatial model using Arc.GIS-10 software (Education license). Spatial model of coastal current was processed using *SMS 8.1* software, as multilayer concept of seawater parameters had been developed by Hartoko and Helmi (2004), then analysed discriptively (Suryabrata, 1983).

## 3. Result and Discussion

Nitrate concentration at Morodemak-Demak coastal water ranged of 0.60-2.0 mg/l. Highest concentration found at station-3 and lowest at station-11 as presented in Tabel 1 and Figure 1. This was assumed that river water brings high concentration of nitrate. Phosphate range from 0.08 - 0.24 mg/l with highest concentration at station-1 or at mouth of the river (Figure 2). Coastal current speed range from 0.0003 - 0.0033 m/s with dominant of southeast direction. Which is considered as the tidal current pattern. In comparison to concentration at the north Papua deepsea water nitrate concentration range of 0.2-0.6 mg/l and phosphate concentration range of 0.02 - 0.2 mg/l (Hartoko and Subiyanto, 2009). Other implication of the current, temperature - depth interactions. Both water current and depth contribute significantly to the vertical temperature profile of North Molucas and Halmahera, with the average current velocity was about 2.5 cm/sec respectively (Robertson and Field, 2005) which is much higher than coastal current of Demak. Related to the productivity processes at coastal water the important parameter is water transparency or turbidity. Where water transparency range of 0.21 - 1.2 m should be relative to the coastal depth.

Table 1. Nitrate, phosphate, current speed and direction, DO, salinity, SST, pH and transparency

St	NO <sub>3</sub> <sup>-</sup> mg/l	PO <sub>4</sub> mg/l	Current (m/s)	Direction (°)	DO mg/l	Salinity (‰)	SST (°C)	pH	Transparency (m)
1	1.20	0.24*	0.0003	225	0.61	18	29.2	7.50	0.21
2	1.50	0.13	0.0006	150	2.51	31	31.5	8.40	0.41
3	2.00*	0.14	0.0008	135	2.72	32	30.0	8.85	0.21
4	1.10	0.08	0.0011	150	2.00	33	29.2	8.95	0.42
5	1.00	0.12	0.0013	140	6.80	33	30.2	8.95*	0.80
6	0.80	0.24*	0.0014	152	3.22	28	31.3	8.85	1.04
7	0.90	0.08	0.0015	150	3.91	33	29.3	8.65	1.02
8	1.10	0.10	0.0022	170	5.00	33	31.7	8.73	0.95
9	0.90	0.15	0.0025	130	6.52	33	32.2	8.72	1.20*
10	0.90	0.04	0.0027	140	6.42	32	30.4	8.76	1.10
11	0.60	0.11	0.0030	254	6.00	33*	29.5	8.64	1.10
12	0.70	0.13	0.0033*	150	7.72*	32	32.5*	8.82	1.05

Note : \* as the highest value

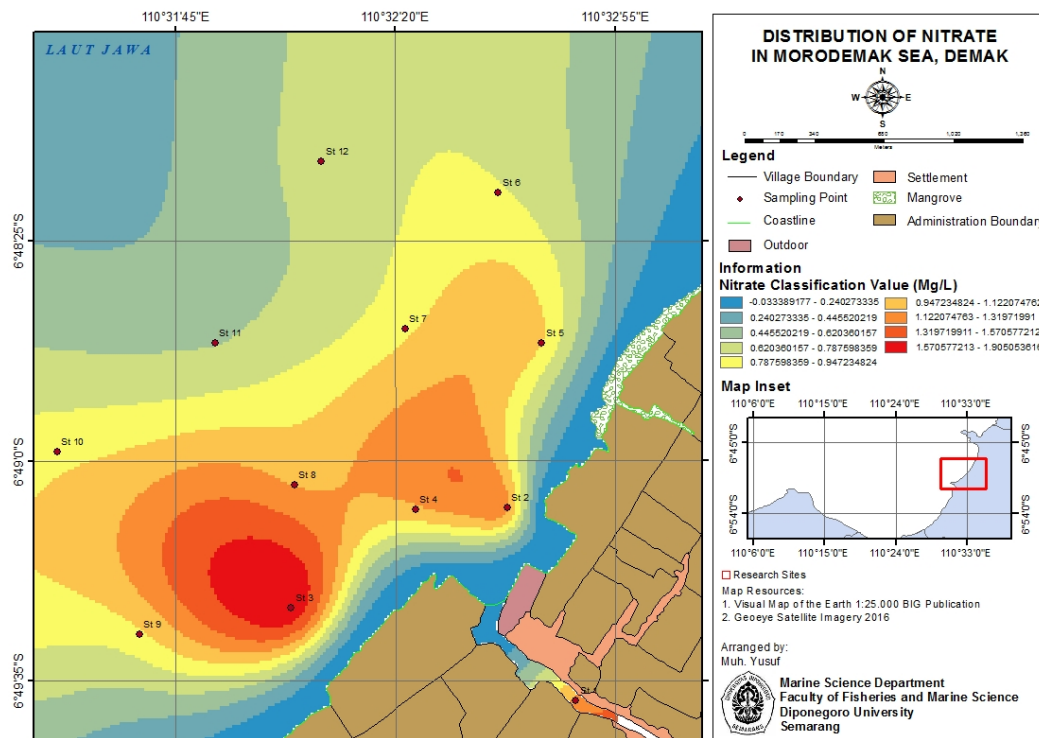

Figure 1. Spatial distribution of nitrate at Morodemak-Demak

Odum (1993) mention that continuous high nutrient concentration of river water flows into coastal water will support the primary productivity. Low concentration of nitrate at station 11 and 12 which the most far station from the mouth of the river. Organic nitrate as mainly come from marine organic metabolism and decomposition. While particulate ones come from sediment degradation (Koesobiono, 1980).

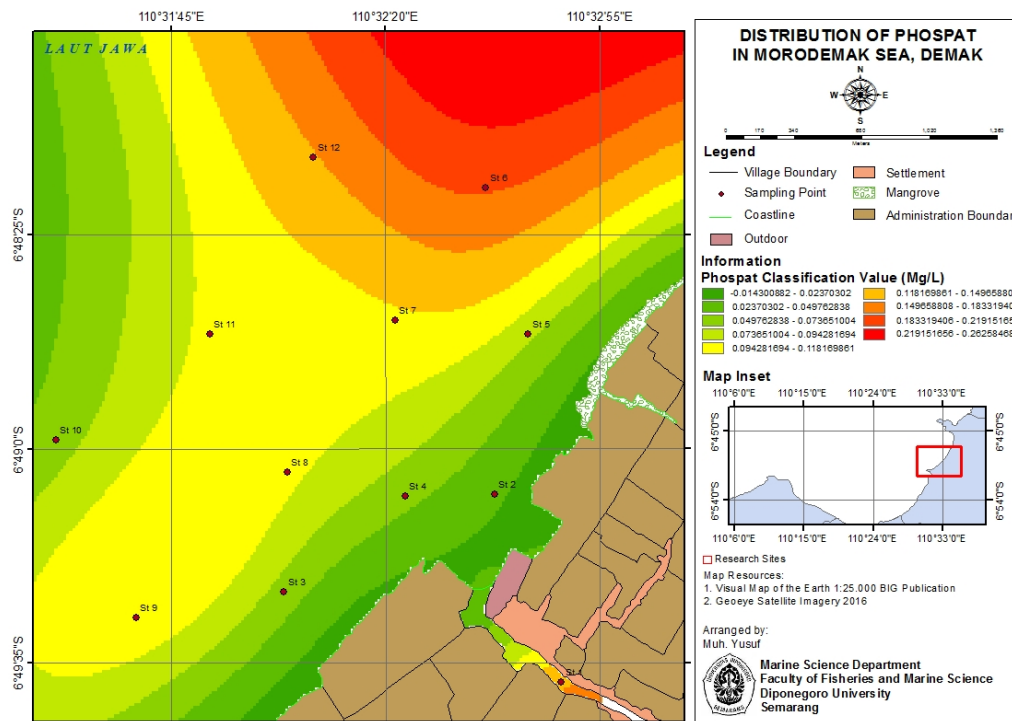

Figure 2. Spatial distribution of phosphate at Morodemak-Demak

High phosphate concentration at station 6 and 12, this kind of spatial distribution pattern was due to the pattern of existing coastal current. As well as moderately high DO concentration around station 6. Salmin (2005) dissolved oxygen as parameter indicator for seawater quality since dissolved oxygen take important role in the process of organic materials oxidation into inorganic particles. Dissolved oxygen also define the biological reaction of aerobic organism in the seawater. In a aerobic condition dissolved oxygen will take role for oxydation of organic and inorganic materials into particulate nutrient and will increase primary productivity. Sastrawijaya (2009) explain that in seawater ecosystem consist of three type of phosphorus substances that is organic phosphorus such as orthophosphate, organic material inside in the protoplasm and dissolved organic phosphate from decomposition process.

About 22 genera of phytoplankton was found, with moderaate domination by Bacillariophyceae, Dinophyceae and most dominant of Rhizosolenia. Highest abundance of phytoplankton at the mouth of the river with 28,090,000 cell/m<sup>3</sup> and lowest at offshore water with 17,060,000 cell/m<sup>3</sup> (Table 2). Highest diversity index ( $H'$ ) was found at this area as well with ( $H'$ ) : 1.606 and lowest of 0.8730 at offshore position. Spatial phytoplankton distribution as presented in Figure 3. In comparison to a deep oceanic water of Papua, Hartoko and Subiyanto (2009) found mainly two groups of phytoplankton had been found in the north Papua deep sea water, that are edible phytoplankton and non-edible phytoplankton groups. The edible phytoplankton with chlorophyll content was found in the upwelling region in the Halmahera and Papua corridor. Non-edible phytoplankton group were characterized with a non-chlorophyll content, having a spiny-silica cell walls (Radiolarians) and some of them were belongs to the toxic Dinoflagelates. Non-edible phytoplankton was mainly spread over the oceanic waters up to 200 mile to the north (Pacific) water.

Coastal current. Coastal current spatial model was done using *SMS* software, where dominant current direction towards south-east to the coastline. Comparison of field current data to the result of current spatial model the value of MRE (*Mean Relative Error*) or meaning that error of field and simulation model is 10.74 %. Meaning that the value of accuracy of the simulated coastal current spatial model is 89.27 %, and scientifically acceptable. This was in accordance with Short (1987) that the value of accepted MRE is about 15%. This specific spatial current model considered as unique for this geographical position of Morodemak as combination effect of an open bay with estuary or mouth of the river.

The spatial current model of the area that estuary or mouth of the river has a unique spatial coastal current pattern as also stated by Wibisono (2011). Result of the spatial current model is considered as the interaction of surface wind, tidal current, bathymetry and coastal land elevation (Figure 4).

Table 2. Phytoplankton abundance at Morodemak-Demak coastal seawater (x000,000 cell/m<sup>3</sup>)

NO	Genera	ST1	ST2	ST3	ST4	ST5	ST-6	ST-7	ST-8	ST-9	ST-10	ST-11	ST-12	TOTAL
	<b>BACCILARIO-PHYCEAE</b>													
1	Amphora	-	4	-	4	6	-	3	-	-	9	-	5	<b>31</b>
2	Bacteriastrum	-	4	-	6	6	3	3	8	11	8	7	4	<b>60</b>
3	Biddulphia	-	6	4	4	6	-	25	8	6	9	5	13	<b>86</b>
4	Chaetoceros	144	28	42	29	62	41	64	168	83	49	117	67	<b>894</b>
5	Coscinodiscus	14	16	10	14	28	24	43	23	12	9	7	11	<b>211</b>
6	Dactyliosolen	82	49	46	29	69	42	64	43	31	93	42	96	<b>686</b>
7	Eucampia	42	22	8	16	14	-	6	13	11	8	13	7	<b>160</b>
8	Hemiaulus	4	22	8	4	46	-	21	27	19	15	8	29	<b>203</b>
9	Leptocylindrus	-	-	-	7	14	-	-	-	-	-	-	-	<b>21</b>
10	Lauderia	10	-	-	-	4	8	10	-	-	5	9	10	<b>56</b>
11	Melosira	-	-	-	-	103	424	62	40	32	41	123	52	<b>877</b>
12	Nitzschia	16	48	18	69	104	127	27	39	65	103	53	91	<b>760</b>
13	Navicula	-	18	14	14	23	4	8	21	32	12	28	33	<b>207</b>
14	Pleurosigma	22	80	44	127	268	129	189	187	94	66	142	167	<b>1515</b>
15	Pelagothrix	-	-	-	-	4	-	3	-	-	8	-	-	<b>15</b>
16	Rhizosolenia	2138	2322	1482	2092	1552	1512	1142	1191	1072	1153	1981	2003	<b>19640*</b>
17	Thalasionema		25	69	213	-	-	49	164	132	58	72	15	<b>797</b>
18	Thalassiotrix	22	74	44	40	82	80	100	63	41	36	74	24	<b>680</b>
19	Triceratium	-	-	-	-	4	8	-	-	6	-	-	9	<b>27</b>
20	Thalassiosira	81	-	-	-	48	87	-	-	25	-	41	-	<b>282</b>
	<b>DINOPHYCEAE</b>													
21	Peridinium	66	83	25	47	6	17	4	23	44	18	37	19	<b>389</b>
22	Ceratium	4	8	8	6	4	3	-	4	12	6	5	10	<b>70</b>
	Total per station	2645	2809	1822	2721	2453	2509	1823	2022	1728	1706	2764	2665	27667

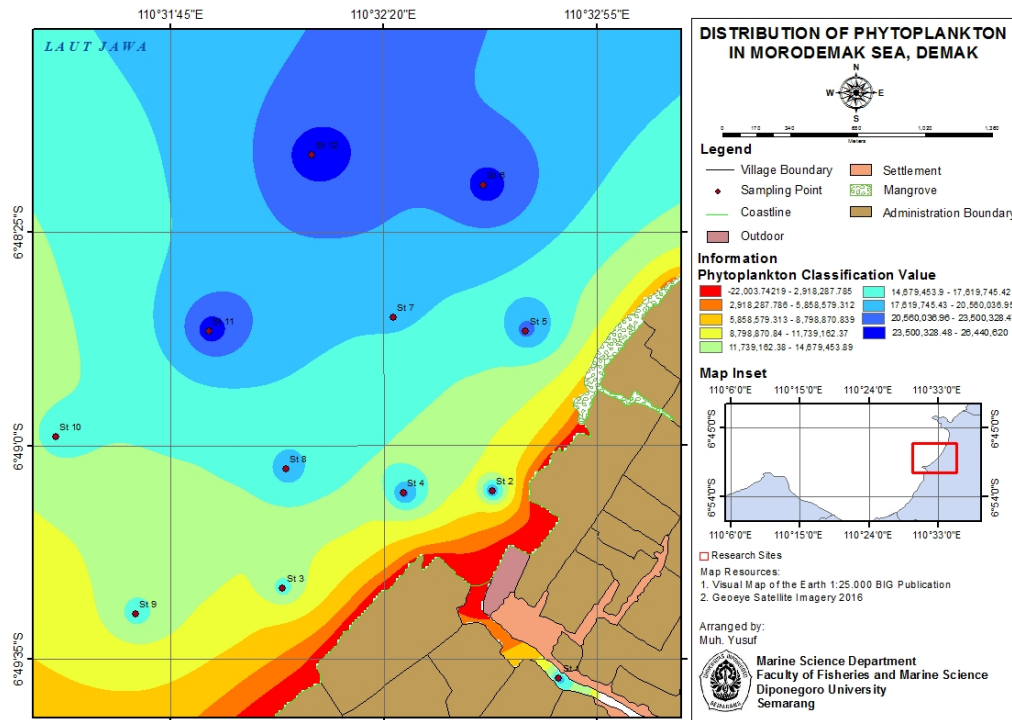

Figure 3. Spatial distribution of phytoplankton at Morodemak-Demak

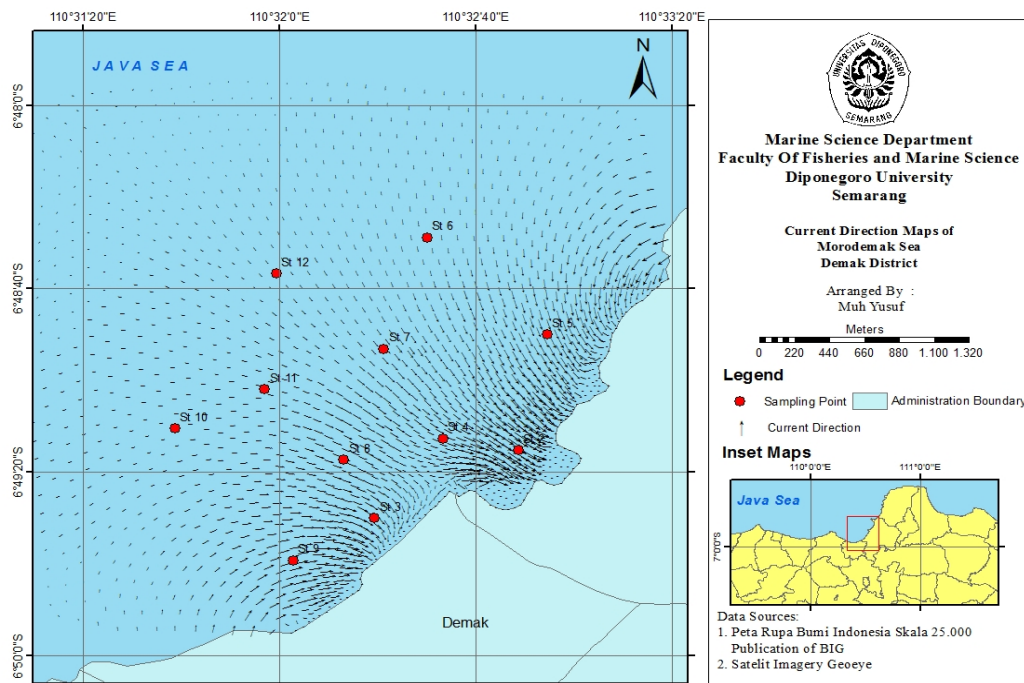

Figure 4. Spatial distribution of phytoplankton at Morodemak-Demak

The study revealed that nutrient distribution in this shallow coastal water was mainly affected by coastal current that is tidal current (Figure 4). Meaning that their spatial distribution pattern was mainly governed by low tide and high tide current. That is towards and offward the coastal water, and ultimately producing a unique spatial

distribution of phytoplankton at this area. Jalil (2013) stated that the resulted coastal current from field data and spatial model using SMS software would be more affected by tidal current pattern.

## Acknowledgements

The author would like to thanks to Riandi for helping the current spatial model, to all staff of Marine Science Department Undip for seawater quality and phytoplankton analysis. Special thanks to University of Bangka Belitung for supporting find to attend the IJSS 2016 at Chiba University - Japan. A sincere thanks to Prof. A. Hartoko for the English language help of the manuscript.

## REFERENCE

- Dahuri, R., J. Rais, S.P. Ginting, and M.J. Sitepu. 2004. Pengelolaan Sumber Daya Wilayah Pesisir dan Lautan Secara Terpadu (Integrated Coastal Resources Management). PT. Pradnya Paramita, Jakarta, 328 pp.
- Fachrul, F.M., H. Haeruman, and L.C. Sitepu. 2005. Komunitas fitoplankton sebagai bio-indikator kualitas perairan Teluk Jakarta. (Phytoplankton Community as Bioindicator of Jakarta Bay). Seminar Nasional MIPA 2005. FMIPA-Universitas Indonesia, 24-26 November 2005, Jakarta.
- Hartoko, A and M. Helmi (2004). Development of Multilayer Ecosystem Parameters Model. Journal of Coastal Development. ISSN : 1410-5217 Vol.7, No.3, June 2004. pp 129-136.
- Hartoko, A and Subiyanto (2009). Spatial Distribution of Phytoplankton, Zooplankton and Larvae at North Papua Deepsea Water. A paper submitted to the Oceanography, USA.
- Jalil, A. R. 2013. Distribusi Kecepatan Arus Pasang Surut Pada Muson Peralihan Barat-Timur Terkait Hasil Tangkapan Ikan Pelagis Kecil di Perairan Spermonde. (Variations of Coastal Tidal Current and its Effect to Pelagic Fish Catch at Spermonde). *Depik*, 2 (1):26-32
- Jones-Lee, A., & G.F. Lee. 2005. Eutrophication (Excessive Fertilization). Water Encyclopedia: Surface and Agricultural Water. Wiley, Hoboken, NJ. p 107-114.
- Koesoebiono. 1980. Dasar Ekologi Umum, bagian IV. Ekologi Perairan. Sekolah Pasca Sarjana. (Basic Ecology. IV. Aquatic Ecology). Jurusan Pengelolaan Sumber Daya Alam dan Lingkungan. Institut Pertanian Bogor.
- Odum, E.P. 1993. Translated (Srigandono. Ed). Fundamental of Ecology. Gajah Mada Press. Yogyakarta.
- Salmin. 2005. Oksigen Terlarut dan Kebutuhan Oksigen Biologi Sebagai Salah satu Indikator untuk Menentukan Kualitas Perairan. (Dissolved oxygen as Indicator for Water Quality). *Oseana*.30: 21-26.
- Sastrawijaya, T. 2009. Pencemaran Lingkungan (Environmental Pollution). PT. Rineka Cipta. Jakarta
- Short, F.T., 1987. Effects of sediment nutrients on seagrasses: literature review and mesocosm experiment. *Aquat. Bot.*, 27: 41-57.
- Sudjana. 1996. Metode Statistik (Statistic Methodology). Jakarta : Erlangga
- Suryabrata, S, (1983), Metodologi Penelitian (Research Methodology). PT Rajagrafindo Persada, Jakarta.
- Wibisono, M.S. 2011. Pengantar Ilmu Kelautan (Introduction of Marine Science) Edisi 2. UI-Press. Jakarta

---

**WATER RESOURCES MANAGEMENT USING RIVER FLOW  
MANIPULATION IN SUKABIMI KARST LANDFORM**

**Jemi Saputra Ahnaf<sup>a</sup>, Syahid Muthahhari Aunillah Durahman<sup>b</sup>, Zufialdi  
Zakaria<sup>c</sup>**

*a,b,c Geological Engineering Faculty of Padjadjaran University, Jl. Raya Bandung-  
Sumedang Km 21, Sumedang, 45363, Indonesia*

---

**Abstract**

Sukabumi regency classified as relatively high rainfall region, but surprisingly when dry season comes, the water that has been obtained from high rainfall just disappear. In the dry season Sukabumi runs into drought and often hit by floods during rainy season. However, drought and floods minimized by the presence of trees that stretched across the region, but over the years the trees continuously degraded and reduced in number due to use of industrial, residential, and plantation. Therefore, needed for another alternative to maintain the stability of water resources. This research aim to preserve water resources from rainy season to use in dry season, with this mind, the problems of water shortages and floods can be solved at once. Because of Sukabumi has large karst landform, it is easier to preserve water using river flow manipulation on this region. The methods that used in this research including studio method and quantitative morphometry analysis. From the analysis of its characteristics, Sukabumi karst landform has significant underground caves and water activities. Moreover, river morphometry shows value of bifurcation ratio (Rb) and drainage density (Dd) are 3.409 and 0.419 km/ sq. km, respectively. This Rb value interprets that the rivers have moderate decrease or increase of flooding water level and are not distorted by geological structures. And Dd value indicates the flow of the rivers are relatively infrequent, high water infiltration, low run-off, and good porosity rocks. In conclusion, those parameters are support to do river manipulation.

*Keywords:* Water; karst landform; river manipulation; bifurcation ratio; drainage density.

---

<sup>a</sup>Corresponding author. Tel.: +6287828909836

*E-mail address:* jemi14001@mail.unpad.ac.id/ jemi100996@gmail.com

**1. Introduction**

*1.1. Research Background*

The research area located between latitudes 7° 0' 0" N - 7° 2' 40.74" N and longitudes 106° 46' 49" E - 106° 49' 31.8" E, covering an area 25 sq. km with the objects study include karst landform characteristics and river morphometry. Administratively, research area located in Sukabumi, a regency in the southern foothills of Mount Gede in West Java, Indonesia, the location is about 80 km south of the national capital, Jakarta. Sukabumi classified as relatively high rainfall region, but the surprising thing is when the dry season



comes, the water that has been obtained from high rainfall just disappear. When the dry season Sukabumi run into drought and when the rainy season often hit by floods. The drought and flood problem has become regular circumstance every year in Sukabumi, moreover, especially drought, its impact affected the economic society because every year always occurred failed harvest for hundreds hectares. However, drought and floods that hit Sukabumi can be minimized by the presence of trees that stretched across the regions, but over the years the trees continuously degraded and reduced in number due to the use of industrial, residential, and plantation. Therefore, needed for another alternative to maintaining the stability of water resources. This research aim to preserve water resources from the rainy season, to use during the dry season using karst landform, with this mind, the problems of water shortages and floods can be solved at once. To achieve that purpose, at first need to (1) determine the characteristics of the karst landform in the research area and (2) determine river morphometry, including the value of bifurcation ratio ( $R_b$ ) and drainage density ( $D$ ). The determination of karst landform characteristics and river morphometry properties are the primary baseline to manipulate the flow of the river, from these aspects can be determined whether the Sukabumi area, especially in the research area allows for manipulation or not.

### *1.2. Sukabumi Water Condition*

Sukabumi has high rainfall average of 3,750 mm / year (Wardani, 2008). Based on IWACO-WASECO data (Puradimaja et al., 2002), Sukabumi has 127 spring points, which that amount are the largest compared with other regions in West Java. With those conditions, the Sukabumi water demands should be met properly, but the fact that occurred when the dry season are the opposite. According to Sukabumi Head Department of Agriculture and Foodstuffs Institute in 2015, Sukabumi suffered great drought, the drought farmland reached 7,357 hectares, with the details 2,013 hectares are mild drought, 2,784 hectares are moderate drought, and 1,642 hectares are severe drought, the drought caused at least 917 hectares of farmlands are failed to be harvested. Moreover, the baffling thing is when the rainy season comes, few regions of Sukabumi often hit by floods. From these circumstances, concluded that the Sukabumi water resources management is quite less. The cause of this oddity still missing the obvious point, but from the standpoint of geology, because Sukabumi located close to the beach, the water obtained from the rain will be more rapidly transported to the sea, so that the water cycle will run faster, and water cannot be utilized effectively. But the outcome would be different if the rain water infiltrated beforehand, thus the water transport to the sea will be longer and the infiltrated water can be used for agricultural or even daily human needs if it enable.

### *1.3. Karst Landform*

As in Jennings (1971), karst is terrain in which soluble rocks are altered above and below ground by the dissolving action of water and that bears distinctive characteristics of relief and drainage. According to Hugget (2007) karst landform refers to limestone terrain characteristically lacking surface drainage, possessing a patchy and thin soil cover, containing many enclosed depressions, and supporting a network of subterranean features, including caves and grottoes, moreover, he explained that karst springs are the natural outlets for water discharging from conduit networks, they typically are developed at a local or regional ground-water discharge boundary-that is, at a location of minimum

hydraulic head in the aquifer. Taylor & Greene state that a karst aquifer can be conceptualized as an open hydrologic system having a variety of surface and subsurface input, throughput, and output flows, and boundaries defined by the catchment limits and geometry of conduits.

One of the uniqueness of karst landform is the ability to preserve water resources. In this case, when water flows on karst surface, it will suddenly disappear into the ground to form underground streams and then appear at the other places as springs, moreover when water occupies underground caves it will be preserved in great numbers due to the availability of space. Karst landform has a major role in the hydrological cycle, the water largely will be infiltrated into the cracks (epikarst) on the surface, which mean subsequently stored in cavities of dissolution for three to four months after the end of rainy season (Ashari, 2012). For this reason, the karst landform is very beneficial to do water resources management if it utilized properly.

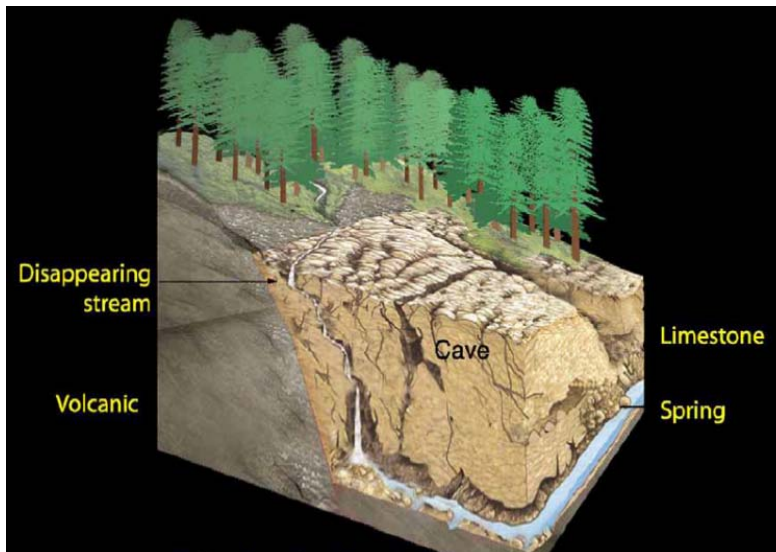

Figure 1. A forested karst landform system (P. Griffiths), karst landform characterized by the presence of underground streams due to dilution, surface water can be infiltrated into the cavities.

Indonesia karst landforms scattered ubiquitous with total wide approximately 15.4 million hectares (Sukandarrumidi & Maulana, 2014), there are at least 24 large-scale karst landforms already recorded, and still very much other karst landforms of various scales that have not been recorded that lied around throughout the Indonesia regions. Furthermore, according to Wahana Lingkungan Hidup Indonesia (WALHI) executive note, in West Java (a province of Indonesia), karst landforms spread over several hills and mountains in 11 regencies, few famous of them are Citatah-Rajamandala (West Bandung), Jagabaya-Cibodas (Bogor), and Sukabumi karst landform (Sukabumi). Hence, with so many karst landforms in Indonesia it would be a very pity if are not used to maintain the water resources management.

## **2. Method**

There are two methods used in this research, they are studio method and quantitative morphometry analysis. The studio method includes creating geological map unit and river order map using MapInfo Professional, Photoshop, and Corel Draw. In creating geological map of the research area, used geological map Jampang and Balekambangan sheet as a base reference, and, river order map carried on the delineation of the watershed of the base map. While, for the analysis of river morphometry including calculate the value of bifurcation ratio and drainage density used Ms. Excel. To support the calculation, the data of river profiles such as river order, stream number, and wide of watershed should already be known.

## **3. Result and Discussion**

### *3.1. River Flow Manipulation*

From the problems that have been described earlier and the ability of karst landform that can store water resources, the solution offered from this paper is to manipulate the river in karst landform, the manipulation carried out by flowing more water to karst landforms using open-close gate (a kind of dam) in the main river. Literally, when rain falls on the high elevation, the water flows evenly to the lower surface by following the rivers, the heavier rain occurs the faster and more volume of water transported, when the river no longer able to accommodate the water, it will spill into the ground, as a result of fair soil porosity and permeability, even worse when it covered by cement or bricks, then will occur a flood. When the flood occurs, necessary to manipulate the water flow of the river, this manipulation conducted by analyzing the porosity (ability to hold fluid) and permeability (ability to ease fluid) around the landforms. Thus, the flow of water no longer flowed evenly divided along rivers, the landform which has good porosity and permeability will obtain water in large amount and vice versa for the landform which has bad porosity and permeability, in other words, the karst landform will obtain more water supply. The idea that explained above is not simple as it seems, need to be analyzed in detail on the characteristics of karst landform and its morphometric river, whether those parameters capable to conduct river manipulation or not.

### *3.2. Characteristics of Sukabumi Karst Landform*

Karst area in Sukabumi covers total area 1.25 million hectares from the elevation 535 to 850 meters above sea level, the karst region is located in a mountainous area consisting of a mixture between natural forests and plants such as Pine, Mahogany, Agathis, and Calliandra (Wardani, 2008). Geologically, at the research area consist of few types of rock units, they are Tmcb (member of Bojonglopang formation), Qpv (volcanic breccia), Qpyt (young terrace deposits), Tmem (Cimandiri formation), Tmjc (Cikarang member), and Qha (alluvium and coastal deposits), in this paper, will be focused to discuss Tmcb unit because posses karst landform. In the geological map, the research are is a part of Jampang and Balekambangan sheet, but the detailed explanation of Bojonglopang formation contained in the Bogor sheet. In the Bogor sheet (geological map), Kusnama and Herman in 1998 explained that Bojonglopang formation consists of solid limestone reefs and sandy limestone layered with a thickness of 250-300 m, suspected aged early Miocene. Bojonglopang formation is karst landform, which is formed by dissolution occurs in limestone.

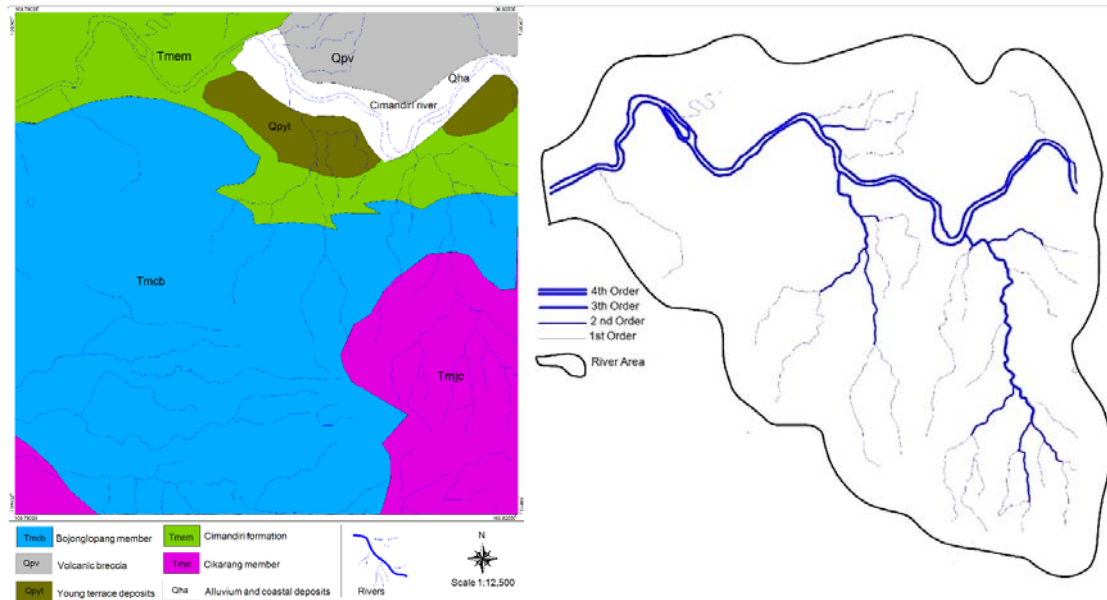

**Figure 2.** The left figure shows geological map unit of research area, covering 25 sq. km with 1: 12500 scaled. While, the right figure shows river order map of part of Cimandiri River in the research area.

Karst systems are divided into three part, they are input (exokarst), throughput (epikarst and endokarst), and output (springs). Exokarst karst system located on the surface, while endokarst lies beneath the surface with generally equipped with underground caves and water activity, Sukabumi karst landform grouped to endokarst system because has few underground caves e.g. Cipucung, Landak, and Caringin Cave, with their presence, the water can be stored largely. These are the profiles of the caves:

**Table 1.** The underground cave profiles of Sukabumi Karst Landform based on work of Wardani (2008)

Name	Length (m)	Depth (m)	Wide (m)	High (m)
Cipucung	187.2	724.1	5.8	4.1
Landak	291.9	745.2	3.9	3.2
Caringin	155.4	754.2	2.4	3.9

### 3.3. River Morphometry

Morphometry is the mathematical analysis of the earth surface configuration, dimension, shape, and landforms (Martins & Gadigba, 2015). The analysis of river morphometry that used to support this manipulation are the bifurcation ratio (Rb) and drainage density (D). The term bifurcation ratio (Rb) is used to express the ratio of the number of streams of any given order to the number of streams in next higher order. Rb value can be divided into three types, less than 3, 3, 3-5, in which each of these values interpret different characteristics of the streams. While, drainage density is the ratio of total channel segment lengths cumulated for all orders within a basin to the basin area, which is expressed in terms of mi/sq. mi or km/sq. km, the drainage density indicates the closeness of spacing of channels, thus providing a quantitative measure of the average length of stream channel for the whole basin (Rao et al., 2010). The interpretation value of drainage density explained by Strahler (1964), which is high drainage density is the

resultant of weak or impermeable subsurface material, sparse vegetation and mountainous relief, and low drainage density leads to coarse drainage texture while high drainage density leads to fine drainage texture. To calculate the value of Rb and D, needed these formulas:

$$R_b = N_o / N_o + 1 \text{ -----(1)}$$

R<sub>b</sub> : bifurcation ratio  
N<sub>o</sub> : Stream number in each order

$$D = \sum L / A \text{ -----(2)}$$

D: drainage density  
L : stream length  
A: wide of watershed

The main river in the research area named Cimandiri River, its pattern is dendritic (twigs like). This pattern is formed in a drainage basin composed of fairly homogeneous rock without control by the underlying geologic structure. The longer the time of formation of a drainage basin is, the more easily the dendritic pattern is formed (Howard, 1967). To determine value of R<sub>b</sub> and D of the rivers, required few data of river profiles such as river order, stream number, total stream length, and wide of the watershed.

Table 2. River profile of research are (part of Cimandiri River)

Order	Stream Number	Total Stream Length (m)	A (m <sup>2</sup> )
1st	31	1017.63	16230000.00
2nd	11	5241.39	
3rd	2	3578.26	
4th	1	7102.51	

With the data derived from the research, and using the existing formulas, obtained value of R<sub>b</sub> 3.409 and the value of D 0.419 km / sq. km. which is according to Strahler interpretation, the bifurcation ratio that ranged between 3.0 and 5.0 for river basins, interpreted that the geological structures do not distort the drainage pattern. In addition, that R<sub>b</sub> value can also be interpreted that the river has increase or decrease of flooding water level is not too fast or slow (intermediate). While the value D 0.419 km / sq. km is classified to low D which means that the morphology of the river has a rough texture, which indicates that the flow of the river is relatively rare, high water infiltration, low run-off, and good rock porosity.

(1) The formula to calculate bifurcation ratio, while (2) used to calculate the drainage density of watershed

#### 4. Conclusion

The problem of water shortage in the research area can be minimized by conduct water resources management using river manipulation in karst landform. The manipulation implements by divide the percentage of water flow from the rainy season in accordance with landform ability in absorbing and storing water, where the distribution

carry out by open-close gate in the main river. Karst landform will derives more water supply in order to store water in it, which then be used in the dry season.

The prominent characteristic of Sukabumi karst landform is the presence of underground caves, named Cipucung, Landak, and Caringin Cave, the caves are very useful as a water storage media, besides that, Sukabumi karst landform classified as endokars system which has many underground water activities. The data processing of river morphometry, shows the value of bifurcation ratio (Rb) and drainage density (D) are 3,409 and 0.419 km / sq. km, respectively. The Rb value interpret that the rivers in the research area have moderate decrease or increase of flooding water level and are not distorted by geological structures. While the D value indicate the flow of the rivers are relatively infrequent, high water infiltration, low run-off, and good rocks porosity. After all, from the parameters of landform characteristic, bifurcation ratio and drainage density of the river, those all are support to do river manipulation.

### **Acknowledgement**

I would like to thank to all colleague of Padjadjaran Intellectual Research on the supports for this long, and special thanks to M. Syarif 'Ali Akbarsyah who has given many advices on research and its writing.

### **References**

- Ashari. (2012). Konservasi Bukit Karst sebagai Tindak Mitigasi Kekeringan di Daerah Tangkapan Hujan Sub-sistem Geohidrologi Bribin-Baron-Seropan Karst Gunung Sewu, Geomedia vol. 10. Indonesia.
- Howard, A. D. (1971). Drainage Anlysis in Geological Interpretation: a Summation, vol. 51, Bulletin of American Association of Petroleum Geology, United State America.
- Hugget, R. J. (2007). Fundamental of Geomorphology, 2nd ed., J. Gerard, Ed, New York, United State America.
- Jennings, J. N. (1971). Karst an Introduction to Systematic Geomorphology, MIT Press, Cambridge Mass., United State America.
- Martins, A. K. And Gadiga, B. L. (2015). Hydrological and Morphometric Analysis of Upper Yedzaram Catchment of Mubi in Adamawa State, Nigeria, Using Geographic Information System ( GIS ), vol. 5, no. 2, pp. 63-69.
- Puradimaja, D. J., Soekarno, I., Abidin, S., and Irawan, D. E. (2002) Sistem Pengembangan dan Pengushahaan Air Bersih di Jawa Barat: Potensi dan Pola Bisni Air Bersih dan Air Minum, in proceeding presented at ITB, Bandung, Indonesia.
- Rao, N., Latha, S., Kumar A., Krishna, H. (2010). Morphometric Analysis of Gostani River Basin in Andhra Pradesh State, vol. 1, no. 2, pp. 179-187, India
- Strahler, A. N. (1957). Quantitative Analysis of Watershed Geomorphology, vol. 38., American Geophysical Union, Unites State America.
- Sukandarrumidi, and Maulana, F. W. (2014). Ada Apa dengan Bentang Alam Karst?, in proceeding SNAST ISSN:1979-911X, Yogyakarta: Indonesia.
- Taylor B. C. J., and Greene, E. A. (\_\_\_) Hydrogeologic Characterization and Methods Used in the Investigation of Karst Hydrology, USGS, United State America.
- Wardani, P. I. (2008) Mofometri Ornamen Gua (Speleopthem) di Kawasan Kars Buniayu, Sukabumi, Jawa Barat, Universitas Indonesia, Depok, Indonesia.

---

**The use of continuous intravenous multimodal analgesia  
fentanyl-ketorolac in patients with caesarean section**

Ardi Pramono\*

*Departement of Anesthesia, Faculty of Medicine and Health Sciences  
Universitas Muhammadiyah Yogyakarta, Indonesia*

---

**Abstract**

Pain after caesarean section should be addressed so that patients feel comfortable and can be mobilized immediately. There are two classes of analgesics that can be used to reduce pain, namely class of opioids and nonsteroidal antiinflammation drug (NSAID). One class of opioids frequently used is fentanyl, whereas the NSAID class using ketorolac. Fentanyl is an opioid analgesic which are lipophilic, so it has several advantages compared to morphine. Ketorolac began to be widely used as an analgesic because of the nature of strong analgesic. This study was compare the use of multimodal analgesia techniques using a continuous intravenous fentanyl-ketorolac and ketorolac bolus intermittent. Subjects consisted of 40 post cesarean section were divided into 2 groups. Group multimodal were 20 people with a multimodal analgesic continuous use, and 20 people with intermittent single drug ketorolac as ketorolac group. Giving analgesics began shortly after the surgery is completed. Both groups were then seen when started to feel pain using a visual analog scale (VAS), and the addition of analgesics if necessary. Results showed 18 patients (90%) with multimodal analgesia had no pain since the completion of the operation up to 24 hours postoperatively (VAS 0-3), 2 patients (10%) need additional bolus intravenous ketorolac at 10 hours postoperatively (VAS 5). A total of 20 patients (100%) with ketorolac group requires 2 times ketorolac injection during 24 hours postoperatively. This study showed that multimodal analgesia technique using fentanyl-ketorolac is superior in reducing post cesarean section pain compared with single drug ketorolac.

**Keywords**

Multimodal analgesia, fentanyl, ketorolac, caesarean section

---

**1. Introducing**

Pain is an unpleasant feeling that arises as a result of tissue damage or potentially causing tissue damage. If acute pain is not treated properly, it can lead to chronic pain, prolong hospitalization, thus increasing hospital costs, and ultimately reduce the satisfaction and comfort of patients (Garimella, and Cellini, 2013). The World Health Organization states that pain is a human right that should be eliminated or reduced. Caesarean section surgery is a major operation that causes moderate to severe pain in more than half of patients who should be treated carefully (Hadi and Hanid, 2011). Postoperative pain caesarean section can cause patient discomfort, patient mobilization

---

\* Corresponding author. Tel.: +628156800919  
E-mail address: ardipramono@umy.ac.id

process becomes longer, thereby increasing the risk of thromboembolism, and can also affect the condition of the mother to immediately take care of the baby.

Pain is complex and multifactorial phenomenon and need multimodal therapy (Joshi, 2005). Relieving drugs commonly used are opioid (Gadsden, et al, 2005), or NSAIDs such as ketorolac, which is proven to reduce pain and dose of opioid if use singly (Lowder et al, 2003). The use either faction opioid analgesics or NSAIDs, can not effectively relieve pain without causing side effects such as nausea, vomiting, sedation, or bleeding (Jin and Chung, 2001). Fentanyl is a synthetic opioid class that works by binding to receptors of the central nervous system and peripheral tissues, as well as have the effect of modulation nociceptor. Compared with morphine, fentanyl has a faster onset of action, is more potent and has a half-life faster, but has the side effect of respiratory depression, so its use is very limited and needs to be more carefully (Garimella, and Cellini, 2013). Ketorolac is a NSAIDs analgesic that can be injected intravenously, works by blocking the production of prostaglandins by inhibiting the enzyme cyclooxygenase (COX-1) and can reduce opioid use between 25-45%. Side effect of ketorolac use is risk of bleeding (Oliveira et al, 2012).

Some studies suggest the use of a combination of opioid and NSAID analgesic drugs with good results, but have not found the optimal combination. Peng dan Sandler (1999) menunjukkan dosis fentanyl 1-2 ug/kgBB/jam, sedangkan di rumah sakit Anne Arundel (2011) memakai dosis 10 ug/jam. In the case of post-operative pain, the addition of drugs known as NSAIDs in intravenous morphine, was found to have good results (Curatolo and Svetcic, 2002). Adding morphine to ketorolac has reduced the side effect and dose dependent of opioid (Cepeda et al, 2005). This study wanted to find out whether the use of a combination of ketorolac and fentanyl in continuous doses can reduce pain better than single use of ketorolac.

## **2. Material and Method**

This prospective study was approved by the institutional ethics in teaching hospitals Faculty of Medicine and Health Sciences, Universitas Muhammadiyah Yogyakarta. The subject of this research is patients who underwent caesarean section at teaching hospital Asri Medical Center (AMC) and PKU Gamping Yogyakarta, and has agreed to participate in the study. A total of 40 patients with a body weight between 40-70 kg, 20-45 years old who underwent caesarean section with ASA 1 and 2 status with spinal anaesthesia since June-August 2016, were included in this study. Exclusion criteria included drug addiction, allergies to opioids and ketorolac, a history of bleeding, and the use of anticoagulant drugs two weeks before surgery.

Subject were divided into two groups, namely the fentanyl and ketorolac group. In fentanyl group, the subjects were given a multimodal analgesic fentanyl-ketorolac, while ketorolac group were given ketorolac intravenous during 20 hour after caesarean section as they feel pain (VAS score>5). Before surgery, all subjects received instruction of the operation and the treatment that will be given to treat postoperative caesarean section pain. All subjects received a spinal regional anaesthesia with a needle no. 25, and the drugs used are spinal bupivacaine 12.5 mg.

After the operation is completed, all subjects were given a single dose of ketorolac 30 mg bolus intravenous, followed by administration of a combination of fentanyl analgesia-ketorolac continuously 20 hours on the subject fentanyl group. On the subject of ketorolac group, bolus administered every subject began to feel the pain and the VAS over 5. All group were given ketorolac 30 mg bolus intravenous immediately after the operation ended. Dose of fentanyl group is 200 ug of fentanyl plus ketorolac 60 mg, dissolved in aqua up to a volume of 100 ml, than fill in syrinx pump (syrinxject), and supplied continuously at a rate of 5 cc / hour, while ketorolac group doses is 30 mg intravenous. Continuous fentanyl doses given 10 ug / h, and continuous dose of ketorolac



0.6 mg / hr. All groups of subjects then recorded how many people who require additional analgesic ketorolac. Collected data is then counted as percentage number of subjects who require ketorolac within 20 hours after surgery.

### 3. Result and Discussion

Forty subjects who participated in this study, were divided into 20 groups of fentanyl, and 20 others are ketorolac group. Age and weight of the data presented in Table 1. In the group of fentanyl, a total of two subjects require additional ketorolac at the 10th hour after surgery because of the pain by VAS score of 5, while all subjects in the group of intravenous ketorolac require an additional two times for 20 hours with VAS score >5. (Table 2).

Table 1. Average of age and body weight

Group	Age (years)	Body Weight (Kg)
Fentanyl	26,5	58
Ketorolac	26	57

Table 2. Amount of subject who need additional ketorolac after 20 hour

Group	Amount (%)
Fentanyl	2 (10%)
Ketorolac	20 (100%)

NSAIDs such as ketorolac, works by blocking the synthesis of prostaglandins by inhibiting the action of the enzyme cyclooxygenase (COX) type I and type II. Decrease in prostaglandin synthesis thereby reducing the production of chemical mediators accompanying acute inflammatory response. Several studies have mentioned that NSAIDs also decrease response to pain centers in the spinal nervous system (White, 2005). Opioid analgesics, such as fentanyl, acts as an agonist in the peripheral and central opioid receptors. Although the analgesic property is efficient, it has side effects such as respiratory depression (Ramsay, 2000) but respiratory depression is extremely rare in the use of continuous intravenous (Peng and Sandler, 1999).

The results showed that administration of a combination analgesic fentanyl and ketorolac continuously can reduce pain in the majority of subject compared with subject who received a single dose of ketorolac only. There were no side effects of nausea and vomiting in both groups. Additional ketorolac in the ketorolac group and fentanyl group showed patients feel pain (VAS score > 5). Ding et al. (1993) suggest that in patients with postoperative gynecological, ketorolac administration singly with a dose of 30 mg intravenously, could not reduce early postoperative pain compared to administration of a combination of ketorolac and fentanyl. Etches et al (1995) demonstrated that ketorolac supplied continuously, can reduce postoperative pain and reduce the dose of morphine given in patients with post-operative hip and knee arthroplasty. In the post-ESWL patients, the use of ketorolac 60 mg iv equally effective for reducing pain and fewer side effects when compared with the 100 ug fentanyl, but with minimal side effects (Yang et al, 2002).

### 4. Conclusion

In this study, administration of a combination of fentanyl-ketorolac continuously can reduce pain better than ketorolac bolus intravenous alone, with minimal side effect. Further research will be needed the most optimal dose and minimal side effects by administering a combination of fentanyl-ketorolac continuously in patients post caesarean section.

## References

- Arundel, A. (2011). Medical Center Critical Care Medication Manual Department Of Nursing And Pharmacy. <https://apps.aahs.org/CriticalCare/Fentanyl%20drip.pdf>
- Cepeda, M.S., Carr, D.B., Miranda, N., Diaz, A.C., Silva, C., Morales, O. (2005). Comparison of Morphine, Ketorolac, and Their Combination for Postoperative Pain: Results from a Large, Randomized, Double-blind Trial. PAIN AND REGIONAL ANESTHESIA | December 2005. <http://anesthesiology.pubs.asahq.org/article.aspx?articleid=2240110#articleTab>
- Curatolo, M., Svetcic, G. (2002). Drug combinations in pain treatment: a review of the published evidence and a method for finding the optimal combination. Best Practice & Research Clinical Anaesthesiology. Volume 16, Issue 4, December 2002, Pages 507-519. <http://www.sciencedirect.com/science/article/pii/S1521689602902545>
- Ding, Yifeng MD; Fredman, Brian MBBCh; White, Paul F. PhD, MD, FANZCA. (1993). Use of Ketorolac and Fentanyl During Outpatient Gynecologic Surgery. Anesthesia & Analgesia: August 1993 - Volume 77 - issue 2. [http://journals.lww.com/anesthesia-analgesia/Abstract/1993/08000/Use\\_of\\_Ketorolac\\_and\\_Fentanyl\\_During\\_Outpatient.1.aspx](http://journals.lww.com/anesthesia-analgesia/Abstract/1993/08000/Use_of_Ketorolac_and_Fentanyl_During_Outpatient.1.aspx)
- Etches, R.C., Warriner, C.B., Badner, N., Buckley, D.N, Beattie, W.S., Chan, V.W.S. Parsons, D, Girard, M. (1995). Continuous Intravenous Administration of Ketorolac Reduces Pain and Morphine Consumption After Total Hip or Knee Arthroplasty. Anesthesia & Analgesia: December 1995 - Volume 81 - Issue 6 - pp 1175-1180 [http://journals.lww.com/anesthesiaanalgesia/Fulltext/1995/12000/Continuous\\_Intravenous\\_Administration\\_of\\_Ketorolac.10.aspx](http://journals.lww.com/anesthesiaanalgesia/Fulltext/1995/12000/Continuous_Intravenous_Administration_of_Ketorolac.10.aspx)
- Fengling. (2002). Frances Chung Multimodal analgesia for postoperative pain control: Journal of Clinical Anesthesia. Volume 13, Issue 7, November 2001, Pages 524-539. <http://www.sciencedirect.com/science/article/pii/S0952818001003208>
- Gadsden, J., Hart, S., Santos, A.C., (2005). Post-Caesarean Delivery Analgesia. Anesthesia & Analgesia: November 2005 - Volume 101 - Issue 5S - pp S62-S69. [http://journals.lww.com/anesthesia-analgesia/Fulltext/2005/11001/Post\\_Cesarean\\_Delivery\\_Analgesia.6.aspx](http://journals.lww.com/anesthesia-analgesia/Fulltext/2005/11001/Post_Cesarean_Delivery_Analgesia.6.aspx)
- Garimella, V, Cellini, C. (2013). Postoperative Pain Control. Clin Colon Rectal Surg. 2013 Sep; 26(3): 191-196. <https://www.ncbi.nlm.nih.gov/pmc/articles/PMC3747287/>
- Hadi, N, Hanid A.A (2011). Lavender essence for Post Cesarean Pain. Pakistan Journal of Biological Science 14 (11): 664-667. <http://scialert.net/fulltext/?doi=pjbs.2011.664.667&org=11>
- Jerry, L.L., Shackelford, D.P., Holbert, D., Beste, T.M. (2003). A randomized, controlled trial to compare ketorolac tromethamine versus placebo after cesarean section to reduce pain and narcotic usage. American Journal of Obstetric and Gynecology. December 2003. Volume 189, Issue 6, Pages 1559-1562. [http://www.ajog.org/article/S0002-9378\(03\)01036-6/fulltext](http://www.ajog.org/article/S0002-9378(03)01036-6/fulltext).
- Joshi, G.P. (2005). Multimodal Analgesia Techniques and Postoperative Rehabilitation. Anesthesiology Clin. N. Am 23; 185-201. <https://www.ncbi.nlm.nih.gov/pubmed/15763418>
- Oliveira, Agarwal D, Benzon, H.T. (2011). Perioperative single dose ketorolac to prevent postoperative pain: a meta-analysis of randomized trials. Anesth Analg. 2012 Feb;114(2):424-33. doi: 10.1213/ANE.0b013e3182334d68. Epub 2011 Sep 29. <https://www.ncbi.nlm.nih.gov/pubmed/21965355>

- Peng, P.W.H. Sandler, A.N. (1999). A Review of the Use of Fentanyl Analgesia in the Management of Acute Pain in Adults. *Anesthesiology* 2, Vol.90, 576-599. <http://anesthesiology.pubs.asahq.org/article.aspx?articleid=1946720>
- Ramsay, M.A., (2000). Acute postoperative pain management. *Bayl Univ Med Cent*, Jul; 13(3): 244-247. <http://www.ncbi.nlm.nih.gov/pmc/articles/PMC1317048/#B12>
- White, P.F. (2005). The Changing Role of Non-Opioid Analgesic Techniques in the Management of Postoperative Pain. *Anesthesia & Analgesia*: November 2005 - Volume 101 - Issue 5S - pp S5-S22. [http://journals.lww.com/anesthesia-analgesia/Fulltext/2005/11001/The\\_Changing\\_Role\\_of\\_Non\\_Opioid\\_Analgesic.2.aspx?trendmd-shared=0#](http://journals.lww.com/anesthesia-analgesia/Fulltext/2005/11001/The_Changing_Role_of_Non_Opioid_Analgesic.2.aspx?trendmd-shared=0#)
- Yang, C.P., Cherng, C.H., Wong, C.S., Ho, S.T. (2002). Effects of intravenous ketorolac and fentanyl combined with midazolam on analgesia and side effects during extracorporeal shock wave lithotripsy. *Acta Anaesthesiologica Sinica* [2002, 40(1):9-12]. <http://europepmc.org/abstract/med/11989050>

---

## **Improving Emotional Intelligence to Develop Healthy Behaviour in Leather Gloves Factory Worker**

Tri Pitara Mahanggoro\*

*Department of Physiology, Faculty of Medicine, Muhammadiyah University of Yogyakarta*

---

### **Abstract**

Lifestyle determines body condition becomes healthy or sick. Healthy lifestyle depends on healthy behavior. Healthy behavior development affected by some factors, such as personal experience, environment, culture, influence of trusted people, mass media, institution, religion, residency, and personal emotion. This study aim to develop healthy behavior of worker at leather gloves factory in Yogyakarta by improving emotional intelligence (EI). This study was performed on two study group (control and treatment) consisted of 10 workers, respectively. Emotional intelligence score and healthy behavior of two study groups were tested by monitoring the answer of questionnaires which given before and after treatment. The groups were given lecture and workshop about emotional intelligence with 4 steps. Each step were consisted of 3 sessions. One Sample Kolmogorov-Smirnov Test and *Pair Sample Test* results shown that there were significant increase of emotional intelligence ( $p=0.02$ ) and healthy behavior ( $p=0.010$ ) after lecture and workshop session. The result of regression analysis shows that there was significant influence of emotional intelligence to healthy behavior of leather gloves factory workers in Yogyakarta. Improving Emotional intelligence could develop healthy behavior of leather gloves factory workers in Yogyakarta.

### **Keywords**

emotional intelligence; healthy behavior; EI program; factory; worker

---

## **1. Introduction**

Healthy lifestyle is determined by individual healthy behavior. Healthy behavior is a self-controller in maintaining the quality of health (Azwar, 2013). Health-related quality of life also has a role in determining the nutritional needs, physical activities, relaxation, and other activities that can develop healthy lifestyle (Notoatmodjo, 2011). On the contrary, unhealthy behavior will affect on the lack of attention to nutritional needs. The quality of attention on achievement of healthy lifestyle needs is determined by personal self-management. One of success factor on self-management is emotional intelligence (Ruiz,*et.al.*, 2012). Emotional intelligence (EI) defined as the ability to

---

\* Corresponding author. Tel.: +62-8122701722; fax: +62-274-566851  
E-mail address: mastripitara@yahoo.com

perceive accurately, appraise, and express emotion; the ability to access and/or generate feelings when they facilitate thought; the ability to understand emotion and emotional knowledge; and the ability to regulate emotions to promote emotional and intellectual growth” (Mayer & Salovey, 1997)

Previous study suggested that emotional intelligence is useful for decreasing the expression level of emotion and self-dependency to others (Linley et al., 2011). The ability in decreasing of emotional expression level is supported by emotional intelligence level against self-emotion (Setyowati et al., 2010). It has been shown that emotional intelligence has a role in self-recognition, awareness, empathy, and good communication skill with others. Leila et al., (2012) have suggested that improving emotional intelligence (EI) also can decrease personality disorder and depression level. EI also takes a role as controller of happiness, will, self-motivation, prevents frustration, empathy, also set the direction of thought and action (Goleman, 2007). EI program on type 2 diabetes mellitus patients was shown positive result on their quality of life (Yalcin et al., 2008). Other study on high school students has shown there is a positive correlation between EI program with motivation to do more physical activities and social interaction, and it also has improved their mental health (Li et al., 2009). Social interaction in a good working environment contributed on the success of a healthy life. The success of a healthy life requires the ability to be patient which is supported with emotional intelligence (Dusseldorp et al., 2010). Healthy lifestyle in the workplace has benefit on reducing risk of accidents (Swaputri, 2010). The purpose of the study was to investigate the effect of an EI program on the health behavior of workers in leather gloves factory.

## **2. Material and Methods**

### *2.1. Design Sample*

Pretest-posttest control group design model was used as the study pattern. A total of 20 leather gloves factory worker volunteered to participate in the program. Respondents were picked using purposive sampling method with inclusion and exclusion criteria. Leather gloves factory worker who have worked for 1 year without mental disorder or under a doctor care were included in the study (a total of 20 workers). Of these 10 were randomized for the study group and 10 for the control group.

Data were obtained by answering the questionnaires as an instrument in emotional intelligence measurement. Questionnaires were answered before and after lecture and workshop session. There were 25 questions in the questionnaire which have been tested using product moment and reliability test using Alpha Cronbach. The result of EI questionnaire was 0.444 shown counted  $r$  was higher than  $r$  table with  $n=20$  and  $\alpha=5\%$

which indicated that questions were validated. Reliability test result using Alpha Cronbach was 0.981 which  $>0.60$  shown that emotional intelligence variables were reliable.

## 2.2. Study Procedure

Study was conducted on September-December 2014 at the meeting room of leather gloves factory in Yogyakarta. Emotional intelligence was measured from all respondents (control and treatment group) by answering the questionnaire before treatments. Lecture and workshop sessions were conducted periodically in 4 steps. Each period consist of 3 sessions with 100 minutes duration. Emotional intelligence after treatment was measured. Data then were analyzed using One Sample Kolmogorov-Smirnov Test and Pair Sample Test.

## 3. Results and Discussion

Table 1 shows that there are no changes of emotional intelligence and healthy behavior on control group for 4 months of the study. This condition indicated that there would be no change of emotional intelligence and healthy behavior without treatment intervention that related to there isno information dynamic on work environment which can stimulate the improvement of worker emotional intelligence (EI). It was correspond with Azwar (2013) that argued healthy behavior (HB) change could be stimulated in persuasive way by putting the new ideas, new thoughts, or opinions into personal thought. Without these stimulations, there will be no change on their life behavior.

Table 1. Outlines the EI and HB Score of Control and Treatment Group.

No.	Code	Pre Test		Post Test		Description
		IE Score	BH Score	IE Score	BH Score	
1.	KRY(control)	60	72	60	72	Relative Constant
2.	DSR(control)	72	75	72	76	Relative Constant
3.	KST(control)	70	76	70	76	Relative Constant
4.	STK(control)	50	60	50	60	Relative Constant
5.	DST(control)	56	60	56	60	Relative Constant
6.	STK(control)	40	65	45	65	Relative Constant
7.	DSN(control)	55	55	55	55	Relative Constant
8.	TGR(control)	50	60	50	60	Relative Constant
9.	MTS(control)	49	70	49	70	Relative Constant
10.	BJY (control)	60	60	60	60	Relative Constant
11.	SR	76	79	77	80	Increase
12.	MYN	60	69	74	73	Increase
13.	TW	65	80	86	85	Increase
14.	TNJ	65	62	67	70	Increase
15.	SNU	82	76	91	92	Increase
16.	ADM	52	70	70	82	Increase
17.	BJY	67	48	68	70	Increase
18.	TMN	65	74	86	79	Increase
19.	SMD	65	63	69	67	Increase

The results of paired samples test (Table 2) show that emotional intelligence scores (pre-test and post-test) was  $p=0.002$  which means in the 95% of confidence interval there were significantly different EI score. Analysis of differences on pretest and posttest healthy behavior (Table 2) was shown  $p=0.010$  which means in the 95% of confidence interval there were significantly different mean scores of healthy behavior.

Table 2. One Sample Kolmogorov-Smirnov Test and Pair Sample Test Scores of Emotional Intelligence and Healthy Behavior after treatments

	Mean	std Deviation	Paired Differences		t	df	Sig. (2 tile)	
			std Error Mean	95% Confidence Interval of the Difference				
				Lower				Upper
Pair 1. EI_Score_Before EI_Score_After	-9.80000	7.43565	2.35136	-15.11914	-4.48086	-4.168	9	.002
Pair 2. HB_Score_Before HB_Score_After	-8.90000	8.63391	2.73028	-15.07633	-2.72367	-3.260	9	.010

The results of the regression analysis are displayed in Table 3. It show that there is significant effect of emotional intelligence on healthy behavior ( $p=0.005$ ). The results showed that improving emotional intelligence has significant effect on the improved health behavior on leather gloves factory workers.

Table 3. ANOVA (b) Regression Test of Emotional Intelligence Effect on Healthy Behavior

Model	Sum of Squares	df	Mean Square	F	Sig.
1. Regression	449,971	1	449,971	14.255	.005(a)
Residual	252.529	8	31.566		
Total	702.500	9			

Description : a. Predictors: (Constant), b. Healthy behavior score after treatment (dependent variable)

There are improvements of emotional intelligence and healthy behavior of workers on treatment group which given lecture and workshop. Pair simple test data (table 2) shown the significant effect of treatment on emotional intelligence ( $p=0.002$ ) and healthy behavior (0.010). The results of ANOVA regression analysis (table 3) explained that there were significant improvement of emotional intelligence ( $p=0.005$ ) with healthy behavior. The emotional intelligence improvement gave the positive effect on leather gloves factory workers in Yogyakarta (Weng *et al.*, 2009). Emotional intelligence could induce self-recognition on someone which cause they become more sensitive on environment and choose wisely between following their desire or healthy life needs. The ability to manage their self-desire controlled by their emotional intelligence

(Reeves, 2005). Goleman (2007) stated that self-awareness can be achieved when someone has high emotional intelligence which can prevent them to do anything that will give negative effects. Self-awareness will give the direction to safety. Self-awareness which developed on leather gloves factory workers has stimulated them to behave in healthy way.

#### **4. Conclusion**

The study demonstrated that there was a significant effect of Emotional Intelligence development training workshop on the workers of leather gloves factory in Yogyakarta.

#### **5. References**

- Azwar, S.(2013). Sikap Manusia Teori dan Pengukurannya, Edisi ke 2, Pustaka Pelajar, Yogyakarta.
- Dusseldorp, L.R.L.C. Van, Meijel, Berno, K. G. Van and Derksen, Jan, J. L. (2010). Characteristics of the Nursing Work Force Emotional Intelligence of Mental Health Nurses. *Journal of Clinical Nursing*, vol. 20, No. 4, pp 555–562 555. doi: 10.1111/j.1365-2702.2009.03120.x
- Goleman, D. (2007). Kecerdasan Emosional, Gramedia Pustaka Utama, Jakarta.
- Mayer J.D., Salovey P. (1997). What is Emotional Intelligence ? In: Salovey P, Sluyter DJ, eds. *Emotional Development and Emotional Intelligence, Implications for Educators*, NY. Basic Books, New York.
- Leila, J., Mohammad, H., Hafez, B., Mohammad, A., Ali, G., Mohammad, K. Z., Serge, B. 2012. Training Emotional Intelligence Improves both Emotional Intelligence and Depressive Symptoms in Inpatients with Borderline Personality Disorder and Depression, *International Journal of Psychiatry in Clinical Practice (Int. J. Psychiatry Clin Pract)*, Vol.16, No.3, pp. 197-204. ISSN:1365-1501 Entry Date: 20121005; Revision Date: 20121026
- Li ,G.S., Lu, F.J.H., Wang, A.H. (2009). Exploring the Relationships of Physical Activity, Emotional Intelligence and Health in Taiwan College Students. *Journal of Exercise Science & Fitness (J Exerc. Sci. Fitness)*. Vol. 15, No. 5, pp.55-63. ISSN: 1728-869X MEDLINE: NLM UID: 101198241.
- Linley, P. Alex; Felus Aimee; Gillett Raphael; Joseph, Stephen,. (2011). Emotional Expression and Growth Following Adversity, Emotional Expression Mediates Subjective Distress and is Moderated by Emotional Intelligence, *Journal of Loss and Trauma*, 16:387–401. ISSN: 1532-5024 *print*=1532-5032 *onlinedoi*: 10.1080/15325024.2011.572036.
- Notoatmodjo, S. (2011). Kesehatan Masyarakat Ilmu & Seni, Rineka Cipta, Jakarta.
- Reeves, Amy, (2005). Emotional Intelligence Recognizing and Regulating Emotions, *AAOHN Journal*, VOL. 53, NO. 4, pp. 50-55.



- Ruiz-A., Desireé, Castillo, R., Salguero, J., Martín, Cabello, Rosario, Fernández, Beroccal P., Balluerka, Nekane. (2012). Short- and Midterm Effects of Emotional Intelligence Training on Adolescent Mental Health. *Journal of Adolescent Health* (JAdolec Health), Vol. 51, No.5 pp. 462-7. doi: 10.1016/j.jadohealth.2012.02.003
- Setyowati, A., Hartati, S., Sawitri, Dian, Ratna. (2010). Hubungan Antara Kecerdasan Emosional Dengan Resiliensi pada Siswa Penghuni Rumah Damai. *Jurnal KE dan Res.pdf*. <http://eprints.undip.ac.id>.
- Swaputri (2010). Analisis Penyebab Kecelakaan Kerja, *Jurnal Kesehatan Masyarakat*, Vol.5, No2, pp. 30-36, <http://journal.unnes.ac.id>.
- Yalcin, B.M., Karahan, T.F., Ozelik, M., Igde, F.A., (2008). The Effects of an Emotional Intelligence Program on the Quality of Life and Well-being of Patients with Type 2 Diabetes mellitus. *Journal of The Diabetes Educator*, Vol.20, No.346, pp. 1013. *MEDLINE UI*: 19075083.
- Weng, H.C., Hung, Ch.M., Liu, Y.T., Cheng, Y.J., Yen, Ch .Y., Chang, Ch.Ch., & Huang, Ch.K. (2009). Associations Between Emotional Intelligence and Doctor Burnout, Job satisfaction and Patient Satisfaction. *Journal Medical Education*. Vol.45 No. 40, pp.835-842. doi:10.1111/j.1365-2923.2011.03985.x. <sup>a</sup> Blackwell Publishing Ltd.

**LONG-TERM IMPACT OF PRENATAL HYPOXIA-ISCHEMIA IN  
SPATIAL MEMORY DURING ADOLESCENCE**

**Ratna Indriawati<sup>a</sup>  
Soedjono Aswin<sup>b</sup>  
Ginus Partadiredja<sup>c</sup>  
Rina Susilowati<sup>d</sup>**

<sup>a</sup>Department of Physiology, Faculty of Medicine and Health Sciences Faculty, Universitas Muhammadiyah Yogyakarta 55183, Indonesia.

<sup>b</sup>Department of Anatomy, Faculty of Medical, Gadjah Mada University, Yogyakarta 55281, Indonesia

<sup>c</sup>Department of Physiology, Faculty of Medicine, Gadjah Mada University, Yogyakarta 55281, Indonesia

<sup>d</sup>Department of Histology and Cell Biology, Faculty of Medicine, Gadjah Mada University, Yogyakarta 55281, Indonesia

---

**Abstract**

Prenatal Hypoxia can cause brain lesions. The effects of hypoxia on neurogenesis during development have been a matter of controversy. Chronic prenatal hypoxia is strong prognosis factor for the outcome of various disease. Prenatal hypoxia contributed to the emergence of several neurological disorders due to abnormalities of brain development such as cognitive and behavioral deficits. Long-tern effects of exposure of hypoxia during early intrauterine development very important to investigate. This study aims to assess spatial memory on Y Maze during adolescence due to prenatal hypoxia-ischemia. This is experiment study. The design of the study is a posttest control group design. Samples were grouped randomly with simple random allocation into 6 groups (3 treatment groups and 3 control groups). Pregnant Sprague-Dawley rats underwent unilateral ligation of the uterine arter, which supplies one uterine horn on E7, E12 and E17. Rats with birth weight over 5.50 g were not used in the present study. Control groups (C7, C12 and C17) were not induced prenatal hypoxia-ischemia. We used 30 male rats divided into 3 treatment groups and 3 control groups. Y Maze was employed to scale the spatial memory. The results showed that the spatial memory significant decreases as the length of prenatal hypoxia-ischemia in adolescence ( $p=0.000$ , CI 95%). Conclusions of this study is prenatal hypoxia-ischemia reduce spatial memory of adolescen *Rattus norvegicus*. The lowest spatial memory is in the group which prenatal hypoxia-ischemia occur at 12 days of pregnancy.

**Keywords**

hypoxic, prenatal, memory, Y Maze

---

## Introduction

Chronic prenatal hypoxia is considered to cause perinatal brain injury. It can result in neurological disorders such as cerebral palsy or learning disabilities. These neurological problems are related to chronic placental insufficiency (CPI), which leads to chronic hypoxemia and hypoglycemia. Prenatal Hypoxia can cause brain lesions. The effects of hypoxia on neurogenesis during development have been a matter of controversy. Chronic prenatal hypoxia is strong prognosis factor for the outcome of various disease (Gilany & Vafakhah, 2010; Chung et al., 2015).

Prenatal hypoxia contributed to the emergence of several neurological disorders due to abnormalities of brain development such as cognitive and behavioral deficits (Rees & Harding, 2004; Barrett, 2007; So et al., 2013). Cell death began to occur approximately 3 hours after the induction of hypoxic ischemic rodentia. The increase in the number of apoptotic cells occurred three days after the induction of hypoxic ischemic prenatal and reached a peak 7 days later. Approximately 14-20 days after induction of hypoxic ischemic prenatal, lesions in the brain tissue (Golan & Huleihel, 2006).

Hypoxia associated with the onset of cognitive disorders, motor and behavioral (Larroque et al., 2008; Fazzi et al., 2009; Deloby et al., 2009). One of the developments that affected the brain is hypoxic cognitive abilities. One cognitive ability is a memory.

Long-term effects of exposure of hypoxia during early intrauterine development very important to investigate. This study aims to assess spatial memory during adolescence due to hypoxic ischemic prenatal.

## Material and Methods

This is experiment study. The design of the study is a posttest control group design. Samples were grouped randomly with simple random allocation into 6 groups (3 treatment groups and 3 control groups).

Pregnant Sprague-Dawley rats were obtained from laboratory research and testing integrated Gadjah Mada University of Yogyakarta, underwent unilateral ligation of the uterine artery, which supplies one uterine horn on E7, E12 and E17, under deep anesthesia (*ketamine hydrochloride* 10 mg/kg intra musculare). We used gradient of growth restriction to differentiate pups after delivery as follows. Pups whose birth weight was below 5.50 g were classified in the treatment groups (P7, P12 and P17). Then rats with birth weight over 5.50 g were not used in the present study. Control groups (C7, C12 and C17) were not induced hypoxic ischemic prenatal.

We used 30 male rats divided into 3 treatment groups (P7, P12 and P17) and 3 control groups (C7, C12 and C17). After weaning on aged 30 days, rats were housed in standard cages (26x45x20 cm<sup>3</sup>). The cages were kept in a temperature and moisture controlled room with 12 hours light-dark cycles (7:00 AM to 7:00 PM) with food and water *ad libitum*. The same rats were used for cognitive test (y maze test), which started on aged 40 days. Before y maze test, the research subjects acclimatization. The subject entered the cage in the test room at least 1 day prior to the test. Test procedure: Animal testing in arm B is placed on the central side and the left moving for 4 minutes (Y maze is great) while monitored by cameras. Scoring is based on the number of achievements of each arm (four feet into the sleeve). The animal returned to the test cage and counted the number of faeces. The equipment is cleaned before being used for testing again. The total amount (total entries) arm achieved. The total

number of test = (total entries-2)  
 Percent alternation = (number of alternation / total test) x100 (Tamura et al., 2006).

## Results

*Rattus norvegicus* males were tested with Y Maze test at the age of 40 days. Percent alternation achieved. The result of Y Maze test showed figure 1.

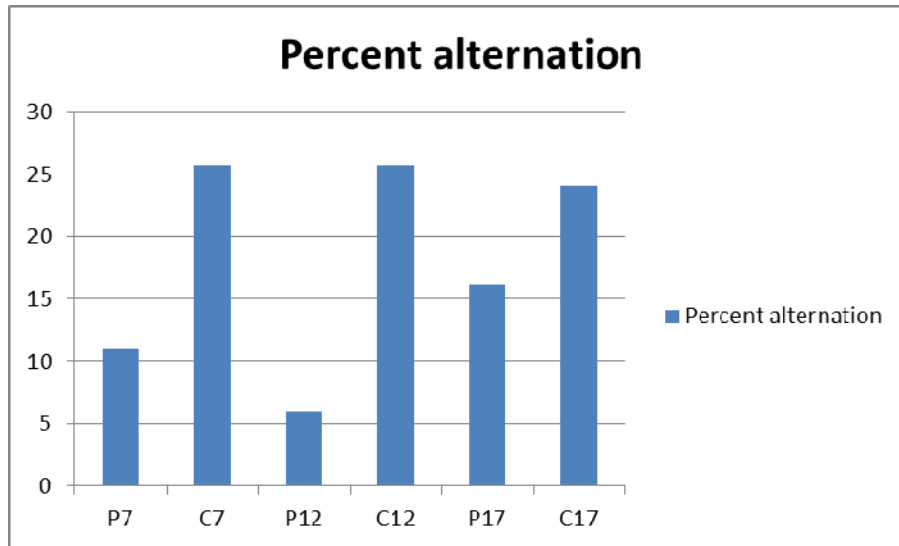

Figure 1. Pattern of Y Maze test from treatment groups (P7, P12 and P17) and control groups (C7, C12 and C17).

Y Maze test showed alternation percent higher in the control group (C7, C12 and C17) compared to the treatment group (P7, P12 and P17). P12 group showed the value of the lowest Y Maze test. The next data is analyzed with ANOVA test. ANOVA analysis test results show a decline in the value of the Y Maze test were statistically significant between treatment groups with the control group ( $p=0.000$ ;  $CI=95\%$ ). Further, data is tested by Post Hoc Test (LSD). Post hoc Test results can be seen in Table 1.

Table 1. Multiple comparison with Post Hoc test (LSD) from Y Maze test treatment groups (P7, P12 and P17) and control groups (C7, C12 and C17).

Group (I)	Group (J)	Mean difference (I-J)	Std error	Sig.	95% confidence interval	
					Lower Bound	Upper bound
P7	C7	-17.050	2.712	0.000	-22.647	-11.542
	P12	-2.896	2.712	0.282	-8.683	2.611
	C12	-18.442	2.712	0.000	-24.039	-12.844
	P17	-9.282	2.712	0.002	-14.879	-3.684
	C17	-19.660	2.712	0.000	-25.257	-14.062

Table 1 shows that there is no impairment of spatial memory were statistically significant between groups P7 with C7, C12 and C15 ( $p=0.000$ ;  $p=0.000$ ;  $p=0.000$ ). Likewise between P7 to P15 group ( $p=0.002$ ). While the group P7 to P12 there are no statistically significant improvement ( $p=0.282$ ).

## Discussion

This study shows that there is spatial memory loss in the treatment group compared to the control group. The decline in spatial memory most likely is in the P12 group. Age 11-15 day rat fetus is a sensitive period of neural development (Sigit, 1992). Prenatal hypoxia-ischemia (HI) refers to a reduced level of oxygen (hypoxia) and a decreased blood flow (ischemia) during fetal development, which can cause various complications during pregnancy associated with neurological deficits and long-term neurodevelopmental disabilities in later life. One of these complications is cerebral palsy that occurs in 2 per 1,000 babies (Graham et al., 2008). Of these, 15% - 20% will die during the postnatal period, and another 25% will develop permanent severe neuropsychological conditions.

Fetal growth and development are a complex and dynamic process that depends on sophisticated interactions among the mother, placenta and fetus to ensure optimal growth and survival conditions (Warner and Ozanne, 2010). Numerous epidemiological, clinical and experimental studies have shown clearly that a compromised intrauterine environment may have subtle or drastic impact on tissue/organ ontogeny, structure and function, and alter the vulnerability or resiliency to some challenges and diseases in later life (Cottrell and Seckl, 2009; Dudley et al., 2011).

Fetal hypoxia affects normal brain development and induces abnormal behavioral presentations. The cerebral cortex, hippocampus and sub-ventricular zone are the most vulnerable regions to the hypoxic insult (Northington et al., 2001). A rat model study has indicated that prenatal hypoxia produces a mild neurological deficit in a variety of behavioral tests. The duration in an accelerating rotarod test was shorter for the offspring with prenatal hypoxic exposure compared to the control offspring, and they traveled a shorter distance and spent most of their time stationary compared with the control group (Ireland et al., 2010). Some structural proteins of the white matter were measured in adult offspring with prenatal hypoxic exposure during gestational days 7 to 21. These structural proteins were associated with normal development of myelin and axon, and their expression levels decreased due to maternal hypoxia while the expression of protein related to astroglia increased, predisposing the individual to white matter changes later in life (Wang et al., 2010).

## Conclusion

Prenatal hypoxia-ischemia reduce spatial memory of adolescent *Rattus norvegicus*. The lowest spatial memory is in the group which prenatal hypoxia-ischemia occur at 12 days of pregnancy.

## References

- Barrett, R.D., Bennet, L., Davidson, J., Dean, J.M., George, S., Emerald, B.S. & Gunn, A.J. (2007). Destruction and reconstruction: hypoxia and the developing brain. *Birth Defects Res C Embryo Today*. 81(3):163-76.
- Chung, Y., So, K., Kim, E., Kim, S. & Jeon, Y. (2015). Immunoreactivity of neurogenic factor in the guinea pig brain after prenatal hypoxia. *J. Ann. Anat.* 200:66-72
- Cottrell EC, Seckl JR. (2009). Prenatal stress, glucocorticoids and the programming of adult disease. *Front Behav Neurosci*. 3:19.
- Deloby, A.M., Arnaud, C., White-Koning, M., Casper, C., Pierrat, V. & Garel, M. (2009). Behaviour problem and cognitive performance at 5 years of age after preterm birth: the EPIPAGE study. *Pediatrics*. 123:1485-1492.
- Dudley, K.J., Li, X., Kobor, M.S., Kippin, T.E. & Bredy, T.W. (2011). Epigenetic mechanisms mediating vulnerability and resilience to psychiatric disorders. *Neurosci Biobehav Rev*. 35:1544-1551.

- Fazzi, E. Bova, S. Giovenzana, A. Signorini, S. Uggetti, C. & Bianchi, P. (2009). Cognitive visual dysfunctions in preterm children with periventricular leukomalacia. *Dev Med Child Neurol.* 51(12):974-81
- Gilany, K. & Vafakhah, M. (2010). Hypoxia: a Review. *J. Paramed. Sci.* Vol 1(2): 50.
- Goyal, R, Papamatheakis, D.G., Loftin, M., Vrancken, K., Dawson, A.S., Osman, N.J., Blood, A.B., Pearce, W.J., Longo, L.D. & Wilson, S.M. (2011). Long-term maternal hypoxia: the role of extracellular Ca<sup>2+</sup> entry during serotonin-mediated contractility in fetal ovine pulmonary arteries. *Reprod Sci.* 18:948-962.
- Graham, H.K., Boyd, R., Carlin, J.B., Dobson, F., Lowe, K., Natrass, G., Thomason, P., Wolfe, R. & Reddihough, D. (2008). Does botulinum toxin a combined with bracing prevent hip displacement in children with cerebral palsy and "hips at risk"? A randomized, controlled trial. *J Bone Joint Surg Am.* 90:23-33.
- Homan, A., Guan, H., Hardy, D.B., Gratton, R.J. & Yang, K. (2006). Hypoxia blocks 11beta-hydroxysteroid dehydrogenase type 2 induction in human trophoblast cells during differentiation by a time-dependent mechanism that involves both translation and transcription. *Placenta.* 27:832-840.
- Ireland, Z., Dickinson, H., Fleiss, B., Hutton, L.C. & Walker, D.W. (2010). Behavioural effects of near-term acute fetal hypoxia in a small precocial animal, the spiny mouse (*Acomys cahirinus*). *Neonatology.* 97:45-51.
- Larroque, B. Delobel, M., Arnaud, C. & Marchand, L. (2008). Outcome at 5 and 8 years of children born very preterm. *Arch. Pediatr.* 15(5):589-591.
- Northington, F.J., Ferriero, D.M., Graham, E.M, Traystman, R.J. & Martin, L.J. (2001). Early Neurodegeneration after Hypoxia-Ischemia in Neonatal Rat Is Necrosis while Delayed Neuronal Death Is Apoptosis. *Neurobiol Dis.* 8:207-219.
- Sigit, K. (1992). Growth and Development of Fetal Rat Brain of Parent Hypothyroidism, Graduate School of Bogor Agricultural University.
- Rees, S & Harding, R. (2004). Brain development during fetal life: influences of the intra-uterine environment. *Neurosci Lett.* 361(1-3):111-114.
- So, K., Chung, Y., Lee, H., Kim, E. & Jeon, Y. (2013). The effect of chronic prenatal hypoxia on the development of mature neurons in the cerebellum. *J. Neurodev. Disord.*, 5:17:1-6.
- Yafeng, D. Weijian, H. Jiaxue, W. & Weiner, C.P. (2009). Chronic hypoxemia absent bacterial infection is one cause of the fetal inflammatory response syndrome (FIRS) *Reprod Sci.* 16:650-656.
- Wang, L., Cai, R., Lv, G., Huang, Z. & Wang Z. (2010). Hypoxia during pregnancy in rats leads to the changes of the cerebral white matter in adult offspring. *Biochem Biophys Res Commun.* 396:445-450.
- Warner, M.J. & Ozanne, S.E. (2010). Mechanisms involved in the developmental programming of adulthood disease. *Biochem J.* 427:333-347.

---

**EFFECTS OF LOW FREQUENCY SOUND VIBRATION TO HUMAN  
PSYCHOLOGICAL AND PHYSIOLOGICAL PHENOMENON : A  
LITERATURE REVIEW**

**Dziban Naufal<sup>a\*</sup>, Ahmad Rofiq Sofyan<sup>a</sup>**

*<sup>a</sup>Departement of Physics, Universitas Padjadjaran, Jalan Raya Badung-Sumedang KM 21,  
Jatinangor 45363, West Java, Indonesia*

---

**Abstract**

Low frequency sound (LFS) is used in Vibroacoustic Therapy (VAT) which categorized as one of Complementary and Alternative Medicine (CAM) fashion. VAT is a therapy fashion that uses audible sound (40 Hz - 120 Hz) to produce vibrations through the transducer which is applied directly to the body. The aim of this paper is to describe the effects of LFS to human psychological and physiological behaviour. The papers were peer-reviewed based on published papers that can be accessed freely online and the essences were combined to synthesize a new conclusion accompanied by the writer's ideas. It is showed that VAT can reduce the anxiety level, indicated by the decrease of average patients blood pressure up to 10.97 bpm. The significance reduction on patients Fibromyalgia Impact Questionnaire (88.8 to 16.8) indicated the capability of VAT to overcome Fibromyalgia's symptoms. The difference of neurite outgrowth frequency in NGF-treated PC12m3 cells between intervention of 40 Hz and 200 Hz vibrational sound condition is significance and potentially lead to the cure Alzheimer disease. LFS in VAT also decrease pain in patients with Juvenile Idiopathic Arthritis due to the reduction of Simplified Disease Activity Index up to 34. Results showed great effects of LFS on the health improvement and human psychology through VAT as a physics agent therapy. However, research about effects of VAT to human health and psychology is still needed due to the lack of information about physics phenomenon in the body with VAT treatment.

**Keywords**

Low frequency sound; Vibroacoustic Therapy; anxiety; Fibromyalgia; Alzheimer; Arthritis

---

**1. Introduction**

Complementary and alternative medicine (CAM) become popular because of its inexpensive cost and lack of side effects if it compared with conventional medicine. According to National Health Interview Survey (NHIS) in 2012, 17.7 % of Americans had used natural products, exclude vitamin and mineral, as a medicine. There are many of CAM types that peoples have usually taken such as herbal medicine, acupuncture, yoga, etc. Vibroacoustic therapy (VAT) is a non-invasive CAM types that transmit low frequency sound directly to the patient's body. VAT is believed have a positive effects to patient's

---

\* Corresponding author. Tel.: +6281320712235  
E-mail address: dziban14001@mail.unpad.ac.id

psychology and health such as reduce pain, anxiety, decreasing blood pressure, and other psychological and physiological phenomenon. However, there is still lack of research which prove the evidence of VAT's capability to overcome diseases or its symptoms.

This literature review's objective is to describe an effects of low frequency sound vibration that is usually used as a physics agent therapy in VAT to human's psychological and physiological behaviour, especially on anxiety, fibromyalgia, Alzheimer, and juvenile idiopathic arthritis (JIA) case. A studies that are cited in this scientific written have a various fashions for executing VAT to the patients so the effects of VAT which describe in this paper are depend on how VAT was done to the patients. This article tells readers about the effects of vibrational sound that traced via questionnaire and psychological and physiological measurement instrument. In special case, the effects that occurred in individual cell are watched on cell at in vitro condition. This paper can aid further research in VAT with a deeper understanding about how low frequency sound acts to the human body.

## 2. Material and Methods

This paper is based on a literature study of some paper which contained primary data that has been published worldwide in several journals. Those papers are free to be accessed through the internet. Writers used these papers to analyze a connection between low frequency sound to the human body and relate a facts that explained by them each other to find some similarities, contradictories, and other relations that reveal other facts or only some writer's reviews. Authors also complemented the analysis with their own arguments and suggestions for further researches. At the end of the analysis, writers make a conclusion based on the examined data and facts that complemented in those papers and reviews from the writers. For gathering a suitable journals or papers that correlated with the effects of low frequency sound to the human body topic, the writers used a search engine and input the desired phrases that referred to the topic, such as "effects of low frequency sound to the human physiology research", "vibroacoustic therapy research", and other phrases that correlated with the topic. This research fashion resulted tens to hundreds of journals or papers that suitable with the topic

## 3. Results

### 3.1 Sound and VAT

Sound is a form of energy that need a medium for transmit through a space or reach some point from the origin point. The molecules of medium are oscillating during the sound transmit through it due to the energy that transferred from one molecule to the other molecule. The oscillated molecules make other molecules to oscillate and those molecules produce a sound as consequence of vibration.

Human can sense the sound through the ear and its vibration through the skin as a periodic displacement. Human can only sense the sound in the certain range of frequency (20-20000 Hz) that called *audible sound*. The sound that can't be sensed by human ear are categorized to be two categories : frequency that fall below 20 Hz are categorized as infrasonic sound, and if fall above 20000 Hz are categorize as ultrasonic sound (Hooper, 2001). Although those kind of sound can't be sensed by human sensory system, they can still affect human body due to their physical characteristic and behaviour, such as they are vibrate in certain frequency, they can be reflected, etc. Sound vibration, the reason why sound is occurred, can affect human body by making certain parts of the body vibrate with the same frequency, called *resonance*.

Vibroacoustic Therapy (VAT) is a new fashion of therapy that uses sound vibration from audible sound as a physical agent that intervene human body with non-invasive



method. This therapy is pioneered by Olav Skille since 1982 that use 30-120 Hz rhythmic sinusoidal sound accompanied by music as therapy purpose (Punkanen et al., 2012). Skille attached six loud speaker as transducer of sound vibration at chair, two speaker were positioned to facing pair of leg, another two speaker at the seat area, and the lasts were at neck and back(Hooper, 2001). Skille believed that VAT is effective to reduce pain and another stress-related symptoms. Nowadays, VAT is a part of musical therapy, that has been used worldwide (Punkanen et al., 2012). VAT become alternative therapy because it were not used drugs to treating patient. VAT purely only use physical agent, vibration and music.

### 3.2 *VAT effect on anxiety*

Anxiety is a normal condition that every people has ever felt. Feeling anxious is normal unless it occurred in a long time and distract daily activity. That kind of anxiety can be categorized as anxiety disorders that differentiate to three more types of disorders: generalized anxiety, panic disorder, and social anxiety disorder. Anxiety can trigger fight or flight response that make body's sympathetic nervous system to release certain kind of hormones such as cortisol. Cortisol can affect human body that can be watched empirically such as fast heartbeat, shortness of breathing, rapid breath, etc. That indicate that anxiety can be watched via physiological phenomenon. The opposite, feeling of relax, means the contraindication of physiological behaviour that occurred due to anxiety.

Tanner has been conducted a research to seek how people with stress condition react after some period of VAT did to them. She make her respondents feeling stress for five minutes with some tests and then let them treated by VAT for five minutes and make them did the same tests once more. The physiological measurements has been conducted for each respondent during tests before and after VAT treatment was did. Those measurements are pulse rate and oxygen saturation level. A questionnaire for respondents was accompanied in that research for seek their personal assumptions about their feeling.

A results from that research are the decrement of pulse rate of 71.43% with average value 10.97 bpm, the increment of saturation of oxygen (SpO<sub>2</sub>) in 35.71% respondents after VAT occurred, and the increment of performance during did the second tests. The questionnaire result showed that 78.57% respondents felt less of anxiety.

Tanner stated that her research has many limitation such as the respondents that already know about music therapy and want to support her research , so that potentially Hawthorne effect was occurred. The respondents also did the same tests after VAT treatment that can be categorized as a limitation too (Tanner, 2012).

### 3.3 *VAT effect on Fibromyalgia*

Fibromyalgia is a chronic syndrome involving generalized joint and muscle pain and fatigue. The etiology of this syndrome is still unknown but physical trauma, emotional trauma, and even human immunodeficiency virus (HIV) infection has been believed as a factors that lead to fibromyalgia. Patients who suffer fibromyalgia are more sensitive to feel a pain due to the mechanical and thermal pain thresholds that lower than healthy people (McCance et al., 2010).

Although there is lack of evidence on any medical treatment capability to cure fibromyalgia, low frequency sound stimulation showed its effectiveness in overcoming fibromyalgia symptoms. It is indicated through some instruments that traced patient's condition that linked with fibromyalgia or its symptoms. The instruments are: Fibromyalgia Impact Questionnaire (FIQ), Jenkins Sleep Scale (JSS), Pain Disability Index (PDI), and Range of Motion (ROM). According to pain impact score on FIQ, there is a vast difference between before low frequency sound stimulation treatment with after treatment (81 %). It showed a significant decrement that mean patients suffer less pain

impact after treatment than before treatment. The significant decrement also showed by JSS (90 %) score after treatment that means sleep disturbance that led by fibromyalgia is overcome through low frequency sound stimulation. The reduction of PDI till 49 % score lead to the conclusion that patients feel less pain after treatment was occurred. The effectiveness of low frequency sound stimulation is shown too through the increment of the ROM score after treatment (Naghdi et al., 2015).

### 3.4 *VAT effect on Alzheimer*

Alzheimer's disease (AD) is a cause of dementia syndrome that leads peoples to several of brain disabilities such as remember, learn, and even do the simplest tasks thanks to massive neurodegeneration of brain that continue to disconnects neurons communication and disrupts their metabolism and repair so neurons are dying and die. There are some risks factors that have been identified which lead to AD such as obesity, hypertension, down syndrome, and etc. Some researchers believe that genetic risk factors take a role in the pathophysiology of this disease. However, etiology of Alzheimer's disease is still unknown and there is need further study to reveal it. AD is currently cannot be cured, although medication such as donepezil, galantamine, and AChE inhibitors are referred for AD patients to slow down AD activity and reduce some symptoms for a length of time. Those medications are have a side effect for patients, such as dizziness, diarrhea, and headache. Therefore, a new therapy has to be discovered for overcoming AD's symptoms or even cure this disease. A study of behavior of drug-hypersensitive PC12 mutant cell (PC12m3 cell) while treated by vibrational sound shown a promising idea for a cure of AD. This cell could display neurite outgrowth and even differentiate to be a nerve cell due to the activity of nerve growth factor (NGF) and p38 mitogen-activated protein kinase (p38 MAPK). Beside of those chemical agents treatment, with the presence of NGF, PC12m3 cell was treated with vibrational sound at 40 Hz and shown a greater of neurites enhancement than without vibrational sound treatment. A 200 Hz vibrational sound was also used too but shown less neurite enhancement than at frequency 40 Hz. The 40 Hz frequency also shown it's capability to trigger p38 MAPK to be activated for neurite outgrowth in PC12m3 and 200 Hz frequency was not showing any neurite enhancement. Although that study shown good effects of vibrational sound on a single cell, the facts that complemented inside it are support the suggestion of capability of vibroacoustic therapy for healing AD. Low frequency vibrational sound that used in VAT could trigger the factors of neurite outgrowth in cell to be activated so there is possibility that VAT could regenerate the brain and replace died and dying neurons in brain with new neurons by send low frequency sound to the brain through a vibrotactiles (Koike et al., 2004).

### 3.5 *VAT effect on Juvenile Idiopathic Arthritis*

Juvenile Idiopathic Arthritis (JIA) is a term for arthritis diseases in children with age 16 or younger. The etiology of JIA, as it's name that complemented idiopathic term that means unknown origin, is not clearly known, but is believed that genetic and environmental factors are involved. Beside both of them, another factors that have possibility to influence the origin of JIA are immunologic and hormonal abnormalities, stress, trauma, and infectious triggers (Espinosa & Gottlieb, 2012). According to International League of Associations for Rheumatology, JIA is classified into seven categories : (1) Systemic Onset, (2) Oligoarthritis, (3) Polyarthritis, Rheumatoid Factor Negative, (4) Polyarthritis, Rheumatoid Factor Positive, (5) Psoriatic Arthritis, (6) Enthesis-related arthritis, (7) Undifferentiated Arthritis. Nowadays, treatments for JIA patients are depending on drugs such as Nonsteroidal Antiinflammatory Drugs (NSAIDS) and Intraarticular Corticosteroids (Haines, 2007). But there is non-pharmacological therapy that shown effectiveness to treat JIA, vibroacoustic therapy. A study has shown that a group of patients that intervened with physical stimulus from vibrational sound

beside conventional drugs, after 12 weeks of treatment, experienced more reduction of swollen joints and improvement of movement range than another group that only treated with conventional drugs. Comparing with group without VAT, The SDAI (Simplified Disease Activity Index) of group with VAT were decreased significantly after treatment. Beside these physiological improvements, VAT shown its contribution to decreasing less sleep and depression level (Ailioaie et al., 2011).

#### **4. Discussion**

Most of researches show that VAT affect human body positively, although some effects in certain condition are insignificant. The positive results to human health indicate that the physical phenomena of vibration in body, in a certain range of frequency, in this case at range audible sound, influence physiological behavior within the human body. But almost all of researches are showing an empiric evidences of benefit of VAT with neglecting the relation between mechanical activity of certain body parts with their physiological occurrence when the vibration occurring. Therefore, there is need a study that review how body work straightaway when vibration was occurred. There will be a review of microscopic scale of physiology, involving cells and their molecules, that providing the main reason of why that empiric physiology data are obtained.

Beside there is need to know how vibration intervene certain body parts straightaway when the vibration start, in certain diseases, there is need to know the pathophysiology and etiology of those diseases for therapy purposes. As an example, fibromyalgia is the diseases with unknown etiology. Naghdi et al, in their research, showed the advantage of low frequency sound stimulation to overcoming fibromyalgia's symptoms. The advantage represents the big potential of vibroacoustic therapy that used LFSS as a physical agent therapy for being alternative medicine for fibromyalgia case. Indeed, VAT is potential to be a cure of fibromyalgia if executed gradually to patient. However, there needs further research about fibromyalgia etiology before concluding what the best treatment for overcoming this syndrome.

Another research that conducted by Koike et al. confirmed the advantage of low frequency sound vibration on triggering brain mutant cell to regenerating neurite for overcoming Alzheimer diseases. However, that study is refer the effects of low frequency sound in a solitary cell and artificial environment so there is need a study of that effect in tissue or organ scale and with brain environment. That research fashion could leads to more discoveries of correlation of the brain and low frequency sound, especially in brain with AD, and to more possibilities of alternative medicine that used sound as physics agent therapy.

Ailioaie et al. also confirmed the benefit of VAT for medical purpose. They conducted research that showed the ability of VAT to reduce a symptoms of JIA patients. These phenomena conclude that VAT is a very potential therapy to treat and heal rheumatoid diseases in the human body without the intervention of drugs and other chemical agents. VAT can revolutionize the way of arthritis therapy and become a new fashion of alternative therapy for patients that suffer joint diseases.

The effect of vibrational sound to human psychology can be known by watching his/her physiology. For example, anxiety influence body to produce cortisol hormone that able to increase blood sugar level. Moreover, anxiety is causing heartbeat more fast, rapid breath, and etc. Therefore, beside questionnaire that filled by participants of research, psychology phenomenon that occurred due to vibrational sound can be learn through physiological analysis. Research by Tanner confirmed the decrement of anxiety level on participants after VAT was conducted to them.

The effect of vibrational sound to the body may be blurred if research are involving music in the therapy. Music can interfere brain and make people who hear it enjoy. That will affect body physiology and make the effect of vibrational sound to the body blur.

There is need further researches to reveal the exact exposure of low frequency sound vibration to the body, especially on the physical aspect, cellular and microscopic scale within the body. Brain also interesting to study because psychological and physiological phenomenon are initiated from the brain. An instrument such as EEG and MRI could be involved for gather a physical data of brain while vibration is occurring.

## 5. Conclusion

Low frequency sound vibration is beneficial in medical therapies according to its advantage to upgrading the physiological condition of the body that followed by an increasing of psychological condition. There is still further research to know how exactly human body responds upon a vibrational stimulus.

## Acknowledgements

We would thank to our colleagues in Kelompok Belajar dan Penelitian (KBP) Biofisika Kedokteran (Medical Biophysics Research Group) and Padjadjaran Intellectual Research (PIR) for supporting us with discussion and etc.

## References

- ADEAR Center. (2012). The Primer of Alzheimer's Disease and the Brain. <https://www.nia.nih.gov/alzheimers/publication/2011-2012-alzheimers-disease-progress-report/primer-alzheimers-disease-and>. September, 2016.
- Ailioaie L. M., et al. (2011). Effects of Physical and Vibroacoustic Therapy in Chronic in Chronic Pain in Juvenile Arthritis. *Revista Romana De Reumatologie*, Vol. XX, Nr. 3, pp. 198-202.
- Alzheimer Disease. [emedine.medscape.com/article/1134817-overview#a4](http://emedine.medscape.com/article/1134817-overview#a4). September, 2016.
- Anxiety Disorders. <https://www.nimh.nih.gov/health/topics/anxiety-disorders/index.shtml>. November, 2016.
- Espinosa, M., Gottlieb B.S. (2012). Juvenile Idiopathic Arthritis. *Pediatrics in Review*, Vol. 3, No. 7, pp. 303-313.
- Haines K. A. (2007). Juvenile Idiopathic Arthritis : Therapies in the 21<sup>st</sup> Century. *Bulletin of the NYU Hospital for Joint Diseases*, Vol. 65, No. 3, pp. 205-211.
- Hooper, J. (2001). An introduction to Vibroacoustic Therapy and An Examination of Its Place in Music Therapy Practice. *British Journal of Music Therapy*, Vol. 15, No. 2, pp. 69-77.
- How Worrying Affects the Body. <http://www.webmd.com/balance/guide/how-worrying-affects-your-body?page=2>. November, 2016.
- Koike Y., et al. (2004). Low-Frequency Vibratory Sound Induces Neurite Outgrowth in PC12M3 Cell in Which Nerve Growth Factor-Induced Neurite Outgrowth is Impaired. *Tissue Culture Research Community*, Vol. 23, pp. 81-90.
- McCance, K.L. et al. (2010). *Pathophysiology : The Biologic Basis for Disease Adults and Children*, Mosby Elsevier, Philadelphia, USA.
- Naghdi, L., et al. (2015). The Effect of Low-Frequency Sound Stimulation on Patients with Fibromyalgia: A Clinical Study. *Pain Research and Management*, Vol. 20, No. 1, pp. 21-27.

- Punikanen, M., Ala-Ruona, E. (2012). Contemporary Vibroacoustic Therapy: Perspectives on Clinical Practice, Research, and Training. *Music and Medicine*, Vol. 4, No. 3, pp. 128-135.
- Tanner, R. (2012). The Effects of Vibroacoustic Music (VAM) in Reducing Performance Level Anxiety in College Students. <http://www.feeltoneusa.com/user-feedback/ewExternalFiles/Sound%20Chair%20Utah%20Research%20Study.pdf>. September, 2016.
- Treating Alzheimer's Disease. [nhs.uk/Conditions/Alzheimer-disease/Pages/Treatment.aspx](http://nhs.uk/Conditions/Alzheimer-disease/Pages/Treatment.aspx). September, 2016.

---

**Identification of Patient Satisfactory Profile for Outpatient  
Pharmaceutical Service at Private and Government Hospital  
within Semarang District**

Pramitha Esha Nirmala Dewi<sup>a</sup>, Novita Dwi Dahliyanti<sup>b</sup>

<sup>a</sup>*School of Pharmacy, Faculty of Medicine and Health Science, Universitas Muhammadiyah  
Yogyakarta, Jalan Lingkar Selatan, Yogyakarta 55183, Indonesia*

<sup>b</sup>*Akademi Farmasi Nusaputera, Jalan Medoho III, Semarang 50166, Indonesia*

---

**Abstract**

In this era of hospital rivalry in Indonesia, patient satisfaction is becoming more important than ever. A hospital has to be able to maintain its quality by meeting patient's expectation for their satisfaction. Indonesian assumption of a condition where private hospitals give better pharmaceutical care than government hospital became a basis of this study to prove scientifically from patient perspective and expectation towards pharmaceutical care in each hospital. Dr Kariadi General Hospital was chosen to represent a government hospital while St Elizabeth as a private hospital representative. Those hospitals was the top referral hospitals in Semarang district, and can be assumed reflecting the population circumstances. This study was a descriptive, cross-sectional study and data acquisition was done through questionnaire based on ServQual model and in-depth interview on 60 out-patient subjects in each hospital. Using Mann Whitney test to find out the difference of satisfactory score between hospitals, he results showed significant differences in empathy dimension ( $p = 0.014$ ) and reliability dimension ( $p = 0.000$ ). From the empathy dimension, it shows that patients feel pharmaceutical care in St Elizabeth hospital gives better concern, where from reliability dimension the patients feel Dr. Kariadi Hospital is more able to give a reliable and accurate service compared to St Elizabeth hospital.

**Keywords**

Satisfaction, Pharmaceutical Care, Hospital, Semarang

---

**1. Introduction**

Patient satisfaction has often been used repeatedly as an indicator for quality measurement in health services. It is mainly because patient satisfaction might influence patient retention, clinical outcomes, and medical malpractice claims (Prakash, 2010). Meanwhile, hospital pharmaceutical practice has been in a constant gradual change. Patient satisfaction depends on the service quality. The term service refers to any kind of attempt done by the service provider to fulfil the customer's needs by giving the specific service. A good service for a patient is determined by the reality that the given service can fulfil the patient's need by using patient's perception of the received service (whether they are satisfied or disappointed, and also the service length of time). A satisfaction is started from the first time patients arrived, until the time they are discharged. A service is formed by 5 service quality principles; tangibles, empathy, assurance, reliability, and responsiveness. The established health service system in Indonesia has a potential to make a difference in consumer's expectation and the received pharmaceutical service between private and government-driven hospitals.

Based on the patient expectation and perception pattern, the management might take a strategic plan to apply an effective and efficient pharmaceutical service standard. Currently there are numerous hospital pharmaceutical installation in Indonesia incapable of giving a standard pharmaceutical service and, subsequently, unable to achieve the expected patient satisfaction toward pharmaceutical installation service. The management, including hospital management, should attempt their highest effort to achieve the highest consumer's satisfaction. Sometimes maximum effort does not give optimal result because the management does not anticipate the existence of any gaps between their and patient's perception toward the received service. Pharmaceutical service in hospital pharmaceutical installation often face similar obstacles due to their lack of understanding of what kind of service needed by the patient and what opinion the patient have towards the given service done by hospital pharmaceutical installation. These obstacles should be overcome by doing survey regarding the difference in consumer's expectation and patient's perception towards the received pharmaceutical service done by hospital pharmaceutical installation. Currently there had been no patient satisfaction analysis in outpatient setting done in Dr Kariadi central hospital's and Elizabeth hospital's pharmaceutical installation; thus whether development done by these hospitals might improve patient satisfaction or not hasn't come into light. Moreover, these hospitals has often been subjected to become sample hospitals because they are big, often become referred hospitals, have more complicated patients, and, thus, might represent population circumstances.

## 2. Material

This study used a closed questionnaire formed by SerQual model method developed by Parasuraman et al. The questionnaire involved 5 quality dimensions; tangibles, reliability, responsiveness, assurance, and empathy. The questionnaire used Likert scale to acquire quantitative data.

**Table I. Response and score based on Likert scale**

Response	Favourable score	Unfavourable score
Highly disagree	1	4
Disagree	2	3
Agree	3	2
Highly agree	4	1

## 3. Methods

### 3.1. Design Study

This study used non-experimental design study. The discrepancy between the expected quality in each hospital and patient's expectation towards pharmaceutical care in government-driven hospital (represented by Dr Kariadi Hospital) and private hospital (represented by Elizabeth hospital) was analysed in statistical analysis where the source data had been acquired in one shot observation.

### 3.2. Population and Sample

The population of this study was all patients taking their prescribed medicine in hospital pharmaceutical installation in Dr Kariadi Central Hospital and Elizabeth Hospital, both were in out-patient setting, between September and October 2011. The subject of this study were patients receiving purposive sampling-based pharmaceutical care and fulfill inclusion criteria as mentioned below:

- a. Have been receiving pharmaceutical care service at least twice in Dr Kariadi hospital's pharmaceutical installation or in Elizabeth hospital's pharmaceutical installation
- b. Took the prescribed medicine in pharmaceutical installation, whether in Dr Kariadi Hospital or in Elizabeth Hospital, during the study time and working

- time as non-insurance covered patients.
- At least 17 years of age and at least have a senior high school degree when the questionnaire were given.
  - Willing to fulfil the questionnaire and were able to communicate well.

Using Lemeshow calculation, 49 respondents were needed for this study. However, at the end of this study 60 respondents were involved for each hospital.

### 3.3. Location and Time of Study

This study was held in Dr Kariadi Hospital and Elizabeth Hospital; both were in Semarang city, between September and October 2011.

## 4. Results

Descriptive analysis done in this study were aimed to show respondent characteristics based on sex, age, education level, occupation, and residence area. The result is as below:

**Table II. Description of Respondent Characteristics in this Study based on Sex, Age, Education Level, Occupation, and Residence Area**

Dr Kariadi Hospital			Elizabeth Hospital		
Description	Sum	Percentage	Description	Sum	Percentage
Sex:			Sex:		
Male	21	35 %	Male	16	27 %
Female	39	65 %	Female	44	73 %
<b>Total</b>	<b>60</b>	<b>100 %</b>	<b>Total</b>	<b>60</b>	<b>100 %</b>
Age (Years):			Age (Years):		
17-20	5	8 %	17-20	5	8 %
21-25	12	20 %	21-25	13	22 %
26-30	3	5 %	26-30	11	18 %
31-35	8	13 %	31-35	10	17 %
36-40	5	8 %	36-40	3	5 %
41-45	9	15 %	41-45	6	10 %
46-50	7	12 %	46-50	5	8 %
>50	11	18 %	>50	7	12 %
<b>Total</b>	<b>60</b>	<b>100 %</b>	<b>Total</b>	<b>60</b>	<b>100 %</b>
Education Level:			Education Level:		
High school	25	41,67 %	SMA	29	48,33 %
Diploma	9	15,00 %	Diploma	5	8,33 %
Bachelor	25	41,67 %	Bachelor	23	38,33 %
Master	1	1,67 %	Master	3	5 %
<b>Total</b>	<b>60</b>	<b>100 %</b>	<b>Total</b>	<b>60</b>	<b>100 %</b>
Occupation :			Occupation :		
Student	12	20 %	Student	15	25 %
Entrepreneur	8	13 %	Entrepreneur	10	17 %
Private worker	12	20 %	Private worker	14	23 %
Civil government worker	5	8 %	Civil government worker	3	5 %
Teacher	1	18 %	Teacher	6	10 %
Housewife	7	12 %	Housewife	10	17 %
Retirement	5	8 %	Retirement	2	3 %
<b>Total</b>	<b>60</b>	<b>100 %</b>	<b>Total</b>	<b>60</b>	<b>100 %</b>
Residence Area			Residence Area		
Semarang	36	60 %	Semarang	48	80 %
Outside Semarang	24	40 %	Outside Semarang	12	20 %
<b>Total</b>	<b>60</b>	<b>100 %</b>	<b>Total</b>	<b>60</b>	<b>100 %</b>

Based on Table II it can be seen that the most distinctive difference was that more respondents from outside Semarang went to Elizabeth Hospital compared to Dr Kariadi Hospital.

Zarei, A., et al (2012) mentioned on his research that SERVQUAL is a valid, reliable, and flexible tool for monitoring and measuring services quality of private hospitals and



enabling the hospital manager to identify particular areas which need improvement by analysing patient's perspective. ServQual analysis in this study showed that both hospitals had negatif gaps in all dimensions, which have a meaning that respondents expectation were higher compared to their perception. However, from more detailed information it was found that, according to respondents, information accuracy given by Dr Kariadi Hospital Pharmacy were higher compared to the expected service. They felt that information given from Dr Kariadi Hospital were reliable. Meanwhile, ServQual analysis for Elizabeth Hospital samples showed that respondents felt they have reached the expectation in terms of pharmacist concern regarding patient's condition during taking medicine, drug administration, and pharmacist willingness in answering patient's questions. Positif gaps in Elizabeth Hospital samples were found in the punctuality of pharmaceutical installation open time, accuracy in handing over the medicine, and medicine stock in pharmaceutical installation.

Patient expectations towards pharmaceutical service were influenced by many factors such as information they have from their surroundings, their previous experiences regarding having pharmaceutical services, and their impression towards organizations responsible for the services. Zarei, A., et al (2012) found that quality improvement efforts should be focused on creating good relationship between patients and hospital practitioners, also considering hospital practitioners to be responsive, credible, and empathetic to the patients.

Table III showed the discrepancy in patient expectation of Dr Kariadi Hospital as a government-driven hospital representative and Elizabeth Hospital as private hospital representative.

**Table III. Difference in Patient Expectation Score in Dr Kariadi Hospital and Elizabeth Hospital**

No	Hospital	Median	Total Score	Mann Whitney Test	Conclusion
1	Dr Kariadi Hospital	3	5102	0,063	Non-significantly differ
2	Elizabeth Hospital	3	5006		

In general, patient expectation in Dr Kariadi Hospital is higher than in Elizabeth Hospital, even though the difference was not statistically significant. This difference was due to patient's dimensional pattern of priorities.

Table IV showed the results of significance test on score difference regarding every dimension between those hospital as follow:

**Table IV. Significance Test Result in Score Difference regarding every Dimension in Dr Kariadi Hospital and Elizabeth Hospital**

No	Dimension	Dr Kariadi Hospital Score	Elizabeth Hospital Score	Mann Whitney Test	Conclulsion
1	<i>Tangibles</i>	963	956	0,922	Non-significant
2	<i>Empathy</i>	884	924	0,014	Significant
3	<i>Assurance</i>	1240	1226	0,557	Non-significant
4	<i>Reliability</i>	1039	964	0,000	Significant
5	<i>Responsiveness</i>	975	936	0,058	Non-significant
	Total	5101	5006	0,064	Non-significant

Despite the difference in every dimension score, only empathy and reliability dimension that differy significantly between Dr Kariadi Hospital and Elizabeth Hospital. In empathy dimension, patient expectation in Elizabeth Hospital were higher than those who went to Dr Kariadi Hospital, while in reliability patient expectation were by much higher in Dr Kariadi Hospital than in Elizabeth Hospital.

Empathy dimension in service refers to the willingness to give attention, give concern to the consumers, being sensitif towards consumer's expectation, and always make an attempt to fulfill the consumer's need. Patient's expectation in Elizabeth

hospital as a private hospital were higher compared to those who seek for help in Dr Kariadi Hospital. Meanwhile, reliability dimension refers to the ability to do service accountably and accurately as advertised or promised. Those who went to Dr Kariadi Hospital had higher expectancy in this dimension compared to those who went to Elizabeth Hospital as private hospital.

Glover and Rivers (2008), mentioned that generally consumers seek the best care with the lowest cost. In the setting of health service this condition is seldom found. Mission, target, and financial support in an institution allows them to hire the best doctors, nurses, supporting staffs, and to get the most sophisticated tools and technology to attract patients. Meanwhile, patients have to choose between these options, and, unfortunately, it often sacrifice on option to get the other option.

According to Undang-Undang No 44 in Year 2009 regarding hospital, the service cost in government-driven hospital is decided by Health Minister or local government, while in private hospital the hospital director make the decision (Anonym, 2009). It can be said that private hospital might make decision regarding service cost deliberately. In accordance with Glover and Rivers, many patient in private hospital ready to sacrifice higher cost in order to get a more comfortable service, thus, in turn, they will have higher expectation in empathy dimension which is the willingness to give attention, give concern to the consumers, being sensitif towards consumer's expectation, and always make an attempt to fulfill the consumer's need.

Rama et al. (2011) defined patient satisfaction as patients' emotions, feelings and their perception of delivered healthcare services, while other authors defined patient satisfaction as a degree of congruency between patient expectations of ideal care and their perceptions of real care received. Lin et al. (2004) showed that ServQual might be used for satisfactory study in the setting of outpatient clinic. They have found out that assurance and empathy dimensions were the highest priorities according to the patients (cit Lin et al. 2009). Lin et al. (2009) also found out that the highest gap belongs to reliability, assurance, and empathy dimensions. Their study also showed that patients expected the doctors to give more time in doctor-patient discussion. Moreover, a study held in Bangladesh by Syed in 2007 found out that tangibles dimension were one of the most important factor in health service (cit Lin et al., 2009). This statement might explain that the assumed important factors might differ in one place and another.

## Conclusion

1. Patient expectation in Dr Kariadi Hospital is higher than in Elizabeth Hospital due to patient's dimensional pattern of priorities, even though the difference was not statistically significant.
2. Empathy and reliability dimension are different significantly between Dr Kariadi Hospital and Elizabeth Hospital.
3. On empathy dimension, patient expectation in Elizabeth Hospital were higher than those who went to Dr Kariadi Hospital, while on reliability patient expectation were by much higher in Dr Kariadi Hospital than in Elizabeth Hospital.

## References

- Anonim, 2009, Undang-undang Republik Indonesia Nomor 44 tahun 2009 tentang Rumah Sakit, Departemen Kesehatan Republik Indonesia, Jakarta
- Glover, S. H., dan Rivers, P. A., 2008, *Health Care Competition, Strategic Mision, and Patient Satisfaction : Research Model and Propositions*, <http://www.ncbi.nlm.nih.gov>, 16 Agustus 2011

- Lin, C.P., Tsai, Y.H., Chiu, C.K. (2009). Modeling Customer Loyalty from an Integrative Perspective of Self-Determination Theory and Expectation-Confirmation Theory, *J Bus Psychol*, **24**, 315-326.
- Lin, D.J., Sheu, I.C., Pai J.Y., Bair, A., Hung, C.Y., Yeh, Y.H., dan Chou, MJ. (2004) *Measuring patient's expectation and the perception of quality in LASIK services*, <http://www.ncbi.nlm.nih.gov>, 16 Agustus 2011.
- Prakash, B. (2010). Patient Satisfaction. *Journal of Cutaneous and Aesthetic Surgery*, 3(3), 151-155. <http://doi.org/10.4103/0974-2077.74491>
- Rama M, Kanagaluru S. K. (2011) A Study On The Satisfaction Of Patients With Reference To Hospital Services, *International Journal of Business Economics & Management Research*, Vol.1, No.3 [online] available at: <http://zenithresearch.org.in>
- Zarei, A., Arab, M., Froushani, A. R., Rashidian, A., & Tabatabaei, S. M. G. (2012). Service quality of private hospitals: The Iranian Patients' perspective. *BMC Health Services Research*, 12(1), 1.

## **Insect-Based Protein: Future Promising Protein Source for Fish Cultured**

Rudy Agung Nugroho<sup>a</sup>

*<sup>a</sup>Animal Physiology, Development, and Molecular Laboratory, Department of Biology,  
Faculty of Mathematics and Natural Sciences Mulawarman University,  
Jl. Barong Tongkok No 4 Gn Kelua Samarinda, East Kalimantan, Indonesia*

---

### **Abstract**

As one of the vital component feed used in fisheries, fishmeal (FM) is generally added to the fish diet to enhance fish growth, digestive performance and absorption of nutrients. This addition contributes significantly to the variable production cost in the aquaculture industry. Moreover, expanded production of carnivorous species requiring high protein, high-energy feeds will further tax global fish meal. Thus, research based on the low-cost budget for feed operating cost should be strategized to assist aquaculturists in enhancing fish productivity. In addition, suitable alternative feed ingredients will have to be utilized to provide the essential nutrients and energy needed to fuel the growth of aquaculture production. To this effect, the use of insect-based protein sources to replace FM that often scarce, expensive, limited availability, and leads to high fish production costs is alternative ways and has been gaining momentum. Currently, Insects have been proposed as one of the potential future protein sources of protein because of the production of insects is highly sustainable in comparison to the production of cattle, pork, and poultry Farming insects is characterized by higher food conversion efficiencies, lower environmental impact, and higher potential to be grown on waste streams. Though some interesting options such as seaweed, Pea protein based products soylent (Liquid food) and Chirps (Cricket Chips) has attracted several researchers on last year, the experiments regarding the use of insect-based protein are gaining a momentum in order to explore and develop the insects as an alternative source of protein for fish culture.

### **Keywords**

Insect; fish meal; fish cultured

---

### **1. Introduction**

As fish demand continues to grow, the strategies to increase fish productivity need to develop. The research based on eco-friendly and sustainable commercial aims should also be strategized to assist aquaculturists in increasing fish productivity. To this effect, the use of fish meal in the fish diet in production systems to improve productivity has been gaining momentum. Fish meal plays an important role ingredient for fish feed (Caruso, 2015). Fish meal is a prime protein source and known as a high-quality, very digestible feed ingredient (Miles and Chapman, 2006; Tantikitti et al., 2016). Fish meal has large unit energy per unit weight which contains protein, lipids (oils), minerals, and vitamins. However, there is a limit amount of carbohydrate in fishmeal.

Fish meal is a generic term for a nutrient-rich feed ingredient used primarily in diets for domestic animals, sometimes used as a high-quality organic fertilizer. Fish meal can be made from almost any type of seafood but is generally manufactured from wild-caught, small marine fish that contain a high percentage of bones and oil, and usually deemed not suitable for direct human consumption. These fishes are considered 'industrial' since most of them are caught for the sole purpose of fishmeal and fish oil production. A small percentage of fishmeal is rendered from the by-catch of other fisheries, and by-products or trimmings created during processing (e.g., fish filleting and cannery operations) of various seafood products destined for direct human consumption.

The fish meal is one of the few major animal industries existing today that still relies greatly on a "hunting-and-gathering" technique. Most fish rendered into a meal is captured at sea. Millions of tons of fishmeal are produced worldwide. Contrary to recent that beneficial to increase weight gain, specific growth rate, feed conversion ratio, protein utilization efficiency, and carcass enhancement, more than tons of fish are used to produce fish meal.

According to United States Department of Agriculture, (2016), Thailand has the highest production of fish meal in Asian region, reaching up to 430.000 metric tons while Japan around 190.000 metric tons and Indonesia about 16.000 metric tons (Figure 1). In 2016, it is estimated that the production annual growth rate of fish meal is up to 3.70% in Vietnam, followed by Japan 2.70%.

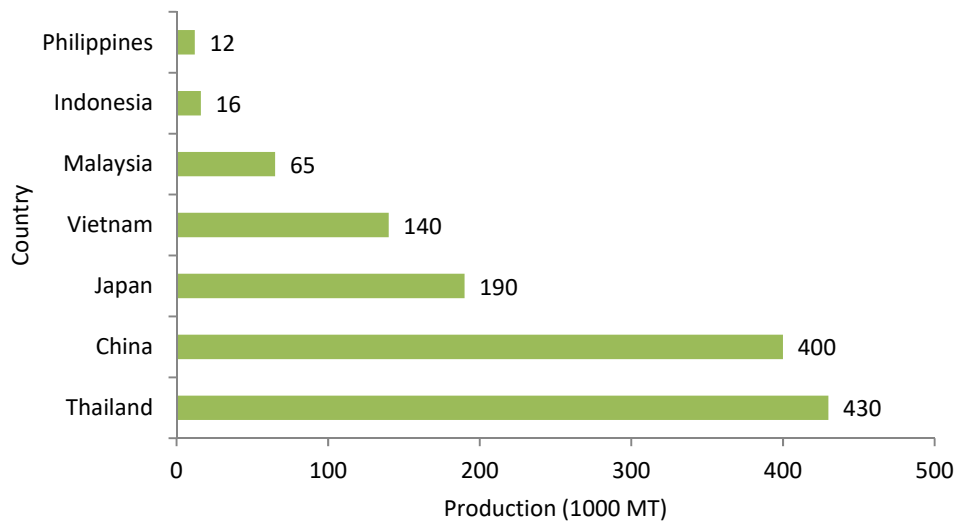

Figure 1. Fish meal production by country (Source: United States Department of Agriculture, 2016)

On the other hand, there is a reducing of fish production in related to the fish meal. The use of fish from nature to produce fish meal is a competition with human needs. Further, the decrease in the availability, sustainability, and the increase in the prices of the fish meal have stimulated the search for sustainable alternatives for aquaculture feeds. It is also stated that feeding fish to fish is useless and wasteful that because more than 6 kg of wild fish is taken up to produce 1 kg of farmed fish (Schipf, 2008). To this regard, the use of protein-based plant is an alternative way to satisfy the increasing demands of the aquaculture feed industry, to partially or totally replace of fish meal in fish diet.

Some attempts have been made to explore the possibilities on the use of plant-based protein to replace total or partial replacement of fish meal. Previous research

stated that many protein-based plants have a good nutritional value including protein content that beneficial to fish growth and physiology (Table 1).

Table 1. The use of plant-based protein and its effects on the growth and physiology of fish

No	Plant-based Protein	Effects	References
1	seaweed <i>Gracilaria arcuata</i>	Better weight gain, specific growth rate, and feed utilization on African catfish, <i>Clarias gariepinus</i>	Al-Asgah et al. (2016)
2	pea protein concentrate	Amino acid profiles of the diets, body composition, and growth performance of juveniles of tench ( <i>Tinca tinca</i> L.)	González-Rodríguez et al. (2016)
3	Soybean meal	Increase marine fish growth	Mo et al. (2016)
4	Lupin	Better apparent digestibility and coefficient of protein (ADC-P) on the Juvenile barramundi ( <i>Lates calcarifer</i> Bloch 1970)	Ilham et al. (2016)
5	Soybean meal, peas, corn gluten, and wheat	Skeletal muscle growth, flesh texture of <i>Senegalese sole</i>	Valente et al. (2016)
6	Canola meal	Growth, feed utilisation, plasma biochemistry, histology of digestive organs and hepatic gene expression of barramundi (Asian sea bass; <i>Lates calcarifer</i> )	Ngo et al. (2016)
7	Cotton Seed Meal without lysine supplementation	Growth performance, body composition and digestive enzyme activities.	Yu et al. (2014)
8	Rice polish	Growth performance of Nile tilapia ( <i>Oreochromis niloticus</i> )	Khan et al. (2013)
9	Wheat gluten	Growth in the range of 40-130 g was superior to the fishmeal control with the diet containing wheat gluten gilthead seabream, <i>Sparus aurata</i> L	Kissil and Lupatsch (2004)

The most famous and intensively used plant-based protein comes from legumes such as soybean, pea and lupin (Caruso, 2015; Glencross et al., 2004). Beside legumes, seaweed (Al-Asgah et al., 2016), and Pea protein based products soylent (González-Rodríguez et al., 2016) have been also attracted some researcher in order to find fish meal replacement. All plant-based protein has been tested for Gold-lined seabream (*Rhabdosargus sarba*), brown spotted grouper (*Epinephelus bleekeri*) and pompano (*Trachinotus blochii*), African catfish, *Clarias gariepinus*, rainbow trout (*Oncorhynchus mykiss*) (Glencross et al., 2004; Mo et al., 2016). However, there are some important issues that need to be addressed such as the occurrence of anti-nutritional factors or known as ANFs (Francis et al., 2001), lack of several amino acid (Rolland, 2014), and environmental issue (Chung, 2016).

Previous research stated that ANFs is alkaloids compound that impact on the palatability, may cause a histological change in intestinal of fish and further can reduce the growth rate of fish (Glencross et al., 2006). Beside alkaloids, lectins, phytate, saponin and proteinase inhibitors have been also identified as anti-nutritional factor that affected on the growth of fish (Hemre et al., 2009). Others research also proved that dietary high level of plant-based protein (>40% of total protein for partial replacement) reduced feed efficiency and growth performances of fish that might be caused by anti-nutritional. Moreover, the amino acids composition of plant-based proteins is less better than animal-based proteins, especially for methionine which contains essential sulphur. Though fish meal and crops such as soya and other plant-based protein are famous as ingredients replacement in animal feed, they are considered as a source of protein that is not ecologically or economically sustainable.

Due to the reason mentioned above, fishmeal is still quite commonly used in animal feed diets. Nevertheless, overfishing, the low availability and the increase in the prices of fish meal which is reflected by increasing market prices over the last decades have stimulated the search for environmentally friendly and eco-sustainable alternatives for animal feeds. Alternative protein sources of comparable value are therefore urgently needed. Thus the potential of insect-based protein in animal feed diets has attracted much attention

## 2. Why insect?

It is predicted by Food and Agricultural Organization (FAO) the world need to enhance food production by 70% by 2050 that would be given to whole population in the world which cover 9 billion people. Almost 80% of the world's agricultural land is occupied for grazing and feeding farm animals. Meanwhile, global meat consumption, especially in relation to fish production is expected to rise by 50% above 2006 levels to meet expected demand by 2050 (Laaninen, 2016).

In order to balance that situation above, a comparable value of alternative protein sources is urgently needed to produce protein source production. Currently, the potential of insect-based protein has attracted much attention not only farmer but also researcher. It seems there are few reasons that can consider in related to the use of insect.

The insects such as crickets, caterpillars and silkworms could be the good source of food in the future. Insects, an edible food that contains protein, vitamins and important amino acids are efficient to be reared. Insects only need six times less feed than cattle and can be cultivated by using organic waste. As consequences, insects produce fewer greenhouse gasses emission (100-1000x) (Frangoul, 2016). The others reasons that could be used as consideration are insects has high feed conversion rate (FCR), low use of water and energy, and nutritious as source of essential protein as well as amino acids for animal feed (Table 2). However, to ensure the less cost production of insect-based protein, the insect must be able to reproduce in short time (Józefiak et al., 2016)

Table 2. Examples of nutrient contents of some insects

Nutrients	House Cricket ( <i>Acheta domesticus</i> )	Meal worm ( <i>Tenebrio molitor</i> )	Silk worm ( <i>Bombyx mori</i> )	Mormon cricket ( <i>Anabrus simplex</i> )	Black fly soldier ( <i>Hermetia illucens</i> )
Crude protein*	55-67	47-60	52-71	60.3 <sup>^</sup>	42 <sup>++</sup>
Fats <sup>^)</sup>	10-22	31-43	6-37	12.9 <sup>^</sup>	35 <sup>++</sup>
Methionine <sup>+</sup>	1.4	1.5	46 <sup>**</sup>	1.4	2.1
Cysteine <sup>+</sup>	0.8	0.8	14 <sup>**</sup>	0.1	0.1
Lysine <sup>+</sup>	5.4	5.4	75 <sup>**</sup>	5.9	6.6

Source: \*Crude protein and ether extracts of fats (% of dry matter) in house cricket, silkworm and mealworm. <sup>+</sup>Amino acid content (g/16 g N) in insects produced as animal feed (Makkar et al., 2014). <sup>\*\*</sup>Amino acid composition of pupae of the silkworm (mg/g crude protein) (Zhou and Han, 2006). <sup>++</sup>protein and fats content (Stamer et al., 2014). <sup>^</sup>Proximate analysis (percent, dry weight) of adult Mormon crickets (DeFoliart et al., 1982).

## 3. Insect-based protein in aquaculture

Traditionally, the application of insect in aquaculture fields has been seen in a recent decade. In Uganda, a research regarding on the use of ingredient such as vegetables, grass, cereals, cereal brands, oil seed cakes, industrial and kitchen wastes fishmeal and insects by fish farmer was reported by Rutaisire (2007) (Figure 2). Unfortunately, the availability of most of these ingredients is seasonal. In addition,

termites for feeding fish that used by fish farmer up to 5% has been collected directly or purchased from collectors at a cost of US\$0.27/kg – only at certain month, March to April and from August to September. The availability of insect is also depending on the number and size of termite hills on the farm, moonlight intensity and termite species. Meanwhile in Southeast Asia region, fluorescent light commonly used as an insect attractant that place above fish ponds. The insect that attracted by light falls into the pond and can be eaten by fish. Wingless grasshoppers and crickets, another example of insect which cannot float, are also made as fish bait (Van Huis et al., 2013).

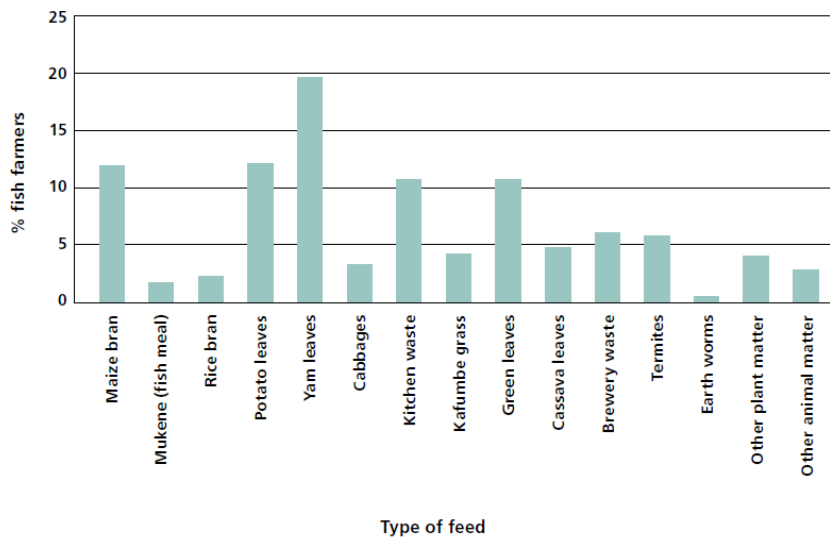

Figure 2. Several of feed types that is used by fish farmer

In current year, fish meal is very popular in aquaculture. Almost 63% of the fish meal is used in aquaculture field (Boyd, 2015). However, due to the low availability and the increase in the prices of fish meal have stimulated the search for environmentally friendly and eco-sustainable alternatives for aquaculture feeds (Caruso, 2015). To this concern, the research to find out new ingredients to replace fish meal has gained a momentum and growth importance specifically in aquaculture field. Recently, the aquaculture field has shown a significant improve and in future the amount of global productions is a key point to provide a pivotal point in supply of seafood to satisfy the growing consumers demand.

Previous research stated that, feeding trials on several fish using ratio 25:50 % of fish meal was replaced with acridid (a genus of grasshoppers) meal produced results similar to the control diet, containing 100 percent fish meal. In addition, growth parameters measured for the selected fish found significantly higher fish fed acridid meal than for fish fed commercial diets. This finding indicates that acridids can be successfully implemented as fish meal replacement (Haldar, 2012). Another successful implementation research of insect as fish meal replacement can be seen in Table 3 below.

Table 3. Insect-based meal and its effect on the growth and physiological of fish

No	Insect-based Protein	Effects	References
1	<i>Bombyx mori</i>	Growth, Survival, body composition, hematological parameters of rainbow trout	(Shakoori et al., 2015; Shakoori et al., 2016)
2	<i>Tenebrio molitor</i>	Growth performance, whole	Gasco et al. (2016)



		body composition and in vivo apparent digestibility on European sea bass ( <i>Dicentrarchus labrax</i> L.) juveniles	
3	<i>Musca domestica</i>	Growth and nutrient utilization indices on African catfish ( <i>Clarias gariepinus</i> )	(Aniebo et al., 2009)
4	Grasshoppers	Growth of <i>Clarias gariepinus</i> fingerlings	(Grace, 2015)
5	Cricket ( <i>Gryllus bimaculatus</i> )	Growth performance, antioxidant enzyme activities, and haematological response of African catfish ( <i>Clarias gariepinus</i> )	(Taufek et al., 2016)
6	Black Soldier Fly <i>Hermetia illucens</i> (Linnaeus, 1758) Prepupae	Growth of <i>Clarias gariepinus</i> (Burchell, 1822)	(Adeniyi and Folorunsho, 2015)

Though insect based protein has many advantages in animal feed specifically aquaculture fields, there are other reasons that need to be considered as the disadvantage of insect meal. More knowledge needed. Some opponent stated that the production costs for insect-based meal are still relatively high; the effects of insect nutrients on the health of animal still need to be further investigated. The legislation will also need to be paid to covering the safe use of substrates such as vegetable and domestic waste and manure that usually is economically made as insect's substrate (Fitches, 2014).

#### 4. Conclusion

The fish meal will stay as a pivotal point in future diets of fish. However, the concerns about the sustainability of these ingredients and the increasing price on the global market are boosting the fish farmer to use a more efficient of fish meal and find alternative feed sources such as insect-based meal. Next research needs to be conducted in order to determine the further effects on the use of insect-based meal on the physiology, immunology, and molecular basis of the animal.

#### Acknowledgement

The author grateful to Department of Biology, Faculty of Mathematics and natural Sciences, Mulawarman University for any kinds of support to present this paper.

#### References

- Adeniyi, O. V., and C. Y. Folorunsho. (2015). Performance of *Clarias gariepinus* (Burchell, 1822) Fed Dietary Levels of Black Soldier Fly, *Hermetia illucens* (Linnaeus, 1758) Prepupae Meal as A Protein Supplement. *International Journal Fish Aquaculture* 5: 89-93.
- Al-Asghar, N. A., E.-S. M. Younis, A.-W. A. Abdel-Warith, and F. S. Shamlol. (2016). Evaluation of red seaweed *Gracilaria arcuata* as dietary ingredient in African catfish, *Clarias gariepinus*. *Saudi Journal of Biological Sciences* 23: 205-210.
- Aniebo, A. O., E. S. Erondy, and O. J. Owen. (2009). Replacement of Fish Meal with Maggot Meal in African Catfish (*Clarias gariepinus*) Diets. *Revista Científica UDO Agrícola* 9: 666-671.
- Boyd, C. E. (2015). *Overview of Aquaculture Feeds: Global Impacts of Ingredient Use Feed and Feeding Practices in Aquaculture*. Woodhead publishing series in food science, technology and nutrition. p 21. Woodhead Publishing, UK.
- Caruso, G. (2015). Use of Plant Products as Candidate Fish Meal Substitutes: An Emerging Issue in Aquaculture Productions. *Fisheries and Aquaculture Journal* 6: 1-3.

- Chung, E. (2016). Shift to Plant-Based Fish Feed Could Hurt Health Environment. <http://www.cbc.ca/news/technology/aquaculture-feed-1.3262922> Accessed 01 October 2016.
- DeFoliart, G., M. Finke, and M. Sunde. (1982). Potential Value of The Mormon Cricket (Orthoptera: Tettigoniidae) Harvested as A High-Protein Feed for Poultry. *Journal of Economic Entomology* 75: 848-852.
- Fitches, E. 2014. Why Are Insects Not Allowed in Animal Feed? *International Magazine on Animal Nutrition, Processing and Feed Management*. p 1-9. Reed Business Media, UK.
- Francis, G., H. P. S. Makkar, and K. Becker. (2001). Antinutritional Factors Present in Plant-Derived Alternate Fish Feed Ingredients and Their Effects in Fish. *Aquaculture* 199: 197-227.
- Frangoul, A. (2016). Insects: Food of The Future? <http://www.cnn.com/2016/03/17/insects-food-of-the-future.html> Accessed 07 August 2016.
- Gasco, L., M. Henry, G. Piccolo, S. Marono, F. Gai, M. Renna, C. Lussiana, E. Antonopoulou, P. Mola, and S. Chatzifotis. (2016). *Tenebrio molitor* Meal in Diets for European Sea Bass (*Dicentrarchus labrax* L.) Juveniles: Growth Performance, Whole Body Composition and In Vivo Apparent Digestibility. *Animal Feed Science and Technology* 220: 34-45.
- Glencross, B., D. Evans, W. Hawkins, and B. Jones. (2004). Evaluation of Dietary Inclusion of Yellow Lupin (*Lupinus luteus*) Kernel Meal on The Growth, Feed Utilisation and Tissue Histology of Rainbow Trout (*Oncorhynchus mykiss*). *Aquaculture* 235: 411-422.
- Glencross, B., D. Evans, N. Rutherford, W. Hawkins, P. McCafferty, K. Dods, B. Jones, D. Harris, L. Morton, and M. Sweetingham. (2006). The Influence of The Dietary Inclusion of The Alkaloid Gramine, on Rainbow Trout (*Oncorhynchus mykiss*) Growth, Feed Utilisation and Gastrointestinal Histology. *Aquaculture* 253: 512-522.
- González-Rodríguez, Á., J. D. Celada, J. M. Carral, M. Sáez-Royuela, and J. B. Fuertes. (2016). Evaluation of Pea Protein Concentrate as Partial Replacement of Fish Meal in Practical Diets for Juvenile Tench (*Tinca tinca* L.). *Aquaculture Research* 47: 2825-2834.
- Grace, O. I. (2015). Effects of Grasshopper Meal in The Diet of *Clarias Gariepinus* Fingerlings. *Journal of Aquaculture Research and Development* 6: 1-3.
- Haldar, P. (Year) of Conference. Evaluation of Nutritional Value of Short-Horn Grasshoppers (Acridids) and Their Farm-Based Mass Production as A Possible Alternative Protein Source for Human and Livestock. In: *Expert Consultation Meeting on Assessing The Potential of Insects as Food and Feed in Assuring Food Security*, Rome. p 23-26.
- Hemre, G., H. Amlund, M. Aursand, A. M. Bakke, R. E. Olsen, E. Ringø, and B. Svihus. (2009). Opinion of the Panel on Animal Feed of The Norwegian Scientific Committee for Food Safety: Criteria for Safe Use of Plant Ingredients in Diets for Aquacultured Fish Norwegian Scientific Committee for Food Safety Norway.
- Ilham, R. Fotedar, and S. Munilkumar. (2016). Effects of Organic Selenium Supplementation on Growth, Glutathione Peroxidase Activity and Histopathology in Juvenile Barramundi (*Lates calcarifer* Bloch 1970) Fed High Lupin Meal-Based Diets. *Aquaculture* 457: 15-23.
- Józefiak, D., A. Józefiak, B. Kierończyk, M. Rawski, S. Świątkiewicz, J. Długosz, and R. M. Engberg. (2016). Insects: A Natural Nutrient Source for Poultry—A Review. *Annals of Animal Science* 16: 297-313.
- Khan, M. S. K., M. A. M. Siddique, and H. Zamal. (2013). Replacement of Fish Meal by Plant Protein Sources in Nile Tilapia (*Oreochromis niloticus*) Diet: Growth Performance and Utilization. *Iranian Journal of Fisheries Sciences* 12: 864-872.
- Kissil, G. W., and I. Lupatsch. (2004). Successful Replacement of Fishmeal by Plant Proteins in Diets for The Gilthead Seabream, *Sparus aurata* L. *The Israeli Journal of Aquaculture* 56: 188-199.
- Laaninen, T. 2016. Insects – Soon to be A Regulated Food? In: M. R. Service (ed.) No. June. p 1-2. European Parliamentary Research Service, Europe.
- Makkar, H. P., G. Tran, V. Heuzé, and P. Ankers. (2014). State of The Art on Use of Insects As Animal Feed. *Animal Feed Science and Technology* 197: 1-33.
- Miles, R., and F. Chapman. (2006). The Benefits of Fish Meal in Aquaculture Diets. *IFAS Extension FA122*: 1-6.
- Mo, W. Y., R. S. S. Lau, A. C. K. Kwok, and M. H. Wong. (2016). Use of Soybean Meal and Papain to Partially Replace Animal Protein for Culturing Three Marine Fish Species: Fish Growth and Water Quality. *Environmental Pollution In Press*; Corrected Proof 1-6.

- Ngo, D. T., N. M. Wade, I. Pirozzi, and B. D. Glencross. (2016). Effects of canola meal on growth, feed utilisation, plasma biochemistry, histology of digestive organs and hepatic gene expression of barramundi (Asian seabass; *Lates calcarifer*). *Aquaculture* 464: 95-105.
- Rolland, M. (2014). Effects of Dietary Methionine on Feed Utilization, Plasma Amino Acid Profiles and Gene Expression in Rainbow Trout (*Oncorhynchus Mykiss*), Technical University of Denmark, Denmark.
- Rutaisire, J. (2007). Analysis of Feeds and Fertilizers for Sustainable Aquaculture Development in Uganda. FAO Fisheries Technical Paper 497: 471.
- Schipp, G. (2008). Is the Use of Fishmeal and Fish Oil in Aquaculture Diets Sustainable? *Technote* 124: 2-15.
- Shakoori, M., H. Gholipour, and S. Naseri. (2015). Effect of Replacing Dietary Fish Meal With Silkworm (*Bombyx mori*) Pupae on Hematological Parameters of Rainbow Trout *Oncorhynchus mykiss*. *Comparative Clinical Pathology* 24: 139-143.
- Shakoori, M., H. Gholipour, S. Naseri, and H. Khara. (2016). Growth, Survival, and Body Composition of Rainbow Trout, *Oncorhynchus mykiss*, when Dietary Fish Meal is Replaced with Silkworm (*Bombyx mori*) pupae. *Archives of Polish Fisheries* 24: 53-57.
- Stamer, A., S. Wessels, R. Neidigk, and G. Hoerstgen-Schwark. (Year) of Conference. Black Soldier Fly (*Hermetia illucens*) Larvae-Meal as An Example for A New Feed Ingredients Class in Aquaculture Diets. In: The 4th ISOFAR Scientific Conference, Istanbul, Turkey. p 1043-1046.
- Tantikitti, C., D. Chookird, and A. Phongdara. (2016). Effects of Fishmeal Quality on Growth Performance, Protein Digestibility and Trypsin Gene Expression in Pacific White Shrimp (*Litopenaeus vannamei*). *Songklanakarin Journal of Science and Technology* 38: 73-82.
- Taufek, N. M., F. Aspani, H. Muin, A. A. Raji, S. A. Razak, and Z. Alias. (2016). The Effect of Dietary Cricket Meal (*Gryllus bimaculatus*) on Growth Performance, Antioxidant Enzyme Activities, and Haematological Response of African Catfish (*Clarias gariepinus*). *Fish Physiology and Biochemistry* 42: 1143-1155.
- Valente, L. M. P., E. M. Cabral, V. Sousa, L. M. Cunha, and J. M. O. Fernandes. (2016). Plant Protein Blends in Diets for *Senegalese sole* Affect Skeletal Muscle Growth, Flesh Texture and The Expression of Related Genes. *Aquaculture* 453: 77-85.
- Van Huis, A., J. Van Itterbeeck, H. Klunder, E. Mertens, A. Halloran, G. Muir, and P. Vantomme. (2013). *Edible Insects: Future Prospects for Food and Feed Security*. FAO, Rome.
- Yu, D. H., S. Y. Gong, Y. C. Lin, and Y. C. Yuan. (2014). Partial Replacement of Fish Meal by Several Plant Proteins With or Without Iron and Lysine Supplement in Diets for Juvenile Chinese Sucker, *Myxocyprinus asiaticus*. *Aquaculture Nutrition* 20: 205-212.
- Zhou, J., and D. Han. (2006). Proximate, Amino Acid and Mineral Composition of Pupae of The Silkworm *Antheraea pernyi* in China. *Journal of Food Composition and Analysis* 19: 850-853.

---

**A Literature Study : Potential of Mango Seed as an Alternative  
Feed of Tegal Duck for Increasing Body Weight**

**Norman Billi<sup>1</sup>, Abdurohman Roja R<sup>2</sup>**

<sup>1</sup>*Padjadjaran University, Jalan Raya Jatiningor-Sumedang KM 22, Sumedang 45363,  
Indonesia*

<sup>2</sup>*Padjadjaran University, Jalan Raya Jatiningor-Sumedang KM 22, Sumedang 45363,  
Indonesia*

---

**Abstract**

Mango seed is an agricultural waste from mango (*Mangifera indica*) which has 15% of the weight of the fruit. Mango seed can be used as an alternative feed for Tegal duck because one mango seed contained NFE (Nitrogen Free Extract) amount of 80.6%. Mango seed is treated to become a mango seed flour and given to Tegal duck. Tegal duck is one of the many local breeds which have maintained by local communities, especially in the area of Tegal, Central Java. The research process was done by searching and comparing secondary data from a journal, textbook, and scientific article reliable relevance. Data obtained based on the result other people research. According to review that has been conducted, mango seed contained a different nutrient and one of them is NFE 80.6%. It is a non-structural carbohydrate and contained glucose, sucrose, fructose, and starch. If NFE calculates will produce metabolizes energy generate to 3220-4220 kcal/kg/dry matter. Metabolizes energy on Tegal duck needs at the age of 8 weeks, to reach a body weight of 1.2 kg is 3100 kcal / kg, so that there is a difference between the energy generated from the content NFE in the mango seed with energy needs in a Tegal duck age of 8 weeks can be stored in the phase of fat consequently the body weight of Tegal duck will increase.

**Keywords**

*body weight, manggo seed, NFE , tegal duck.*

---

\*Corresponding author : +6282214449312  
E-mail address : Norman14022@mail.unpad.ac.id

**1. Introduction**

Indonesia is an agriculture country almost people who live at Indonesia work at an agriculture sector . So many products resulted from an agriculture sector. Agriculture sector gives a contribution 26.05 % toward national income at 2009. On of product resulted from an agriculture sector which high produced that is mango (*Mangifera indica* L).

Production of mango at Indonesia at 2014 that is 2.431.330 ton or about 12.28% form total national fruit product. Center production of mango at Indonesia is Java island with total production 1.813.281 ton or about 74.58 % form total national fruit production. The high production of mango will come negative impact that is an increasing waste which has resulted from mango that is mango seed. Until now mango seed still not utilized to benefit thing. So mango seed will become pollution that contaminates the environment and required some innovation for changing mango seed become benefit thing to society.

Based on that problem, mango seed is a waste from mango which has the potential for become as an alternative feed of Tegal duck. Tegal duck is local poultry from west java which has experience one of that is the high production of the egg. Utilization mango seed as an alternative feed of Tegal duck can give a positive impact toward accretion body weight of Tegal duck.

Based on that explanation, this paper reviewing about “ A Literature Study : Potential Mango Seed as an Alternative Feed of Tegal Duck for Increasing Body Weight”.

## 2. Material and Method

As a scientific written of a literature study, this study is based on the secondary data analysis complemented by primary data collection. The literature that used have any collaboration analysis and synthesis from several journal that has been published globally in the world and several textbook that published by publisher that known by agriculture student. Several of literature reference was used by writer to synthesize and became a consideration within arrange the problems about mango seed. Beside textbook, writer also used several book review of study and research, editorial several journals, and meta-analysis journal. The journal in this study is a journal with free full text.

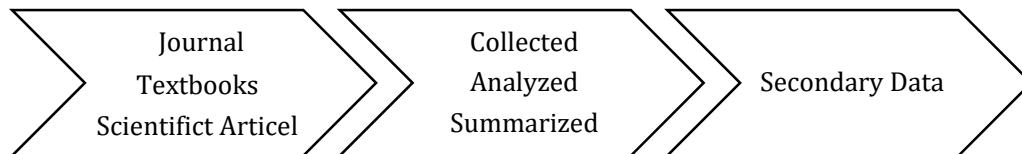

Picture 1. Proses of Literatur Review

## 3. Process of Making Mango Seed Flour

Mango seed is treated become mango seed flour for given as feed to Tegal duck and enter to feed ratio of Tegal Duck. The process of making seed flour based on the process of making jackfruit seed. According to Achmad Fadilah (2008) process of making that flour that is :

- Seed washed with use fresh water.
- Seed boiled together with charcoal to remove odors with a temperature of 1100C with a time of 30 minutes.
- Seed are separated form residue of pulp.
- Seed are cut so easily in the drying process.

The Process of drying up until becoming flour, doing with some of way among that with letting food material under sunlight, which known a naturally drying or by using artificial heat in form hot air from that oven. Drying in the sun can indeed be effective because the temperature is achieved around (35-450°C). The climate in the tropical region is a source of energy very considerable potential. It can also be dried in a drying

oven Cabinet Dryer machine with a temperature of 600°C for 2 hours. The drying process aims for reducing the water contain in that seed (Ishak and Sarinah,1995).

The next step is to grind the seed pieces that have been dried up into fine granules, using a dry blender or grinding tools such as grinding machines rice. Fine granules are then sieved to 60 mesh sieve holes with three times sieved so as to produce the desired flour.

#### 4. Percentage of Mango Seed Flour in Feed Ratio of Tegal Duck

The principle of creation feed ratio for the Tegal duck, that makes feed ration with nutrient contain appropriate with nutrient requirements of Tegal duck for getting the desired results. Therefore a knowledge of the nutrient content of constituents of rationality and knowledge of the nutrient requirements of Tegal duck very important for creating feed ratio of Tegal duck.

**Tabel 1.** Nutrient Requirements of Duck in Diferent Age

Nutrient	Starter (0-2 week)	Grower (2-7 week)	Germ
Crude Protein (%)	22	16	15
Energi (kcal EM/kg)	2900	3000	2900
Metionin (%)	0.40	0.30	0.27
Lisin (%)	0.90	0.65	0.60
Ca (%)	0.65	0.60	2.75
P (%)	0.40	0.30	-

**Source :** NRC (1994)

Feed for duck can give with two way that is in form wet or dry. Average requirements feeds for Tegal duck per head per day percentage at table 2.

**Tabel 2.** Average Requirements of Duck per Head per Day

Age (Week)	Amount (gr)	Age (Week)	Amount (gr)
1	15	12	76
2	30	13	76
3	40	14	70
4	60	15	70
5	65	16	80
6	70	17	80
7	70	18	95
8	72	19	90
9	74	20	90
10	74	21	100
11	75	22	110

**Source :** Supriadi (2011)

Formulation feed of Tegal duck in grower phase (5-22 weeks) that is with assuming if the amount of giving feed 65-110 gram/head/ day according to with age levels as a benchmark is the amount of protein 14-16% and metabolizable energy (EM) 2800 Kcal / kg (Supriadi 2011). According to Supriadi (2011), Feed Formulation for Tegal duck as the Feedstuff major energy source that is using corn with a range of 20-45%.

Mango seed flour can use as-is a substitute for corn because the mango seed flour contained NFE 80,6 % and if calculated will generate metabolize energy almost same with corn that is 3220-4220 kcal/kg/dry matter. So the percentage obtained of mango seed in feed ratio of Tegal duck growers phase (5-22 weeks) as follow :

- Mango seed flour 20 %, bran 20 %, 15 % soy, coconut cake 5 %, fish meal 10 % and bone meal 5%.
- Mango seed flour or bran 50 %, peanuts, coconut cake or soy 15 %, snail 25 %, mineral 5 % and reduce is mixture Vit B12, premix, and cassava leaf.
- Mango seed 45 %, bran 15%, coconut cake 5 %, soy 15%, lamtoro leaf meal 5%, fish meal 10%, dry grass 2%, flour shells 2%, bone meal 1% and a little salt.
- Mango seed flour 20%, concentrate 10%, bran 60% and water hyacinth 10%.

## **5. Mechanism of NFE Content in Mango Seed Flour for Increasing Tegal Duck Body Weight**

The giving mango seed which, processed into mango seed flour toward Tegal toward Tegal Duck could be expected to increase a body weight of that Tegal duck. Therefore This case because a high NFE content in mango seed if calculated will generate energy more than the energy requirement of Tegal duck at age 8 weeks for reach body weight of 1.2 kg. NFE if calculated will generate energy 3200-4220 kcal/kg/ dry matter (Angorodi, 1979), the energy requirement of Tegal duck in 8 weeks for reach 1,2 kg is 3100 kcal/kg so the difference between the energy generated from NFE content in mango seed 32with Tegal duck at age of 8 weeks will be stored ass fat. This case appropriate with Wahyu (2005) that is feed with high energy will generated meat is full of fat, while the low energy level of feed will produce low-fat meat. This excess energy can be converted into body fat, resulting in a final condition that is ready to be harvested.

The mechanism of change remainder of NFE energy into fat which NFE component consisting of easily digestible carbohydrates are glucose, fructose, sucrose and starch when taken into the body to be digested and converted into energy through a process of metabolism. The excess energy which generated for NFE content in feed ration given to Tegal duck at age 8 weeks will be changed become fat through lipogenesis process. Insulin is one of a hormone that is closely related to carbohydrate metabolism .Insulin produced by the beta cells found in the pancreas. This hormone will put out if there increasing of blood sugar levels. When livestock eats carbohydrate to much, blood sugar in livestock body will experience a surge that will be produced more insulin to normalize.

Insulin work with the move a blood sugar into a cell for changed become energy and glycogen (glycogen is deposited of energy). If the cell is already full of glycogen, the excess blood sugar is converted into fat through a process called lipogenesis. The excess sugar will change to be Acetyl-CoA compound in advance. The next stage Acetyl-CoA will change become malonyl-CoA through a series of processes. Malonyl-CoA that has been formed will be converted back to the free fatty acids will be stored in the form of triglycerides in adipose tissue.

## 6. Conclusion

- Mango seed given to Tegal duck processed first into flour mango seed to be easily given to the Tegal ducks.
- Mango seed flour is an alternative feed sources of energy, in the feed ration of Tegal ducks have a percentage ranged between 20% - 50%.
- The content NFE (Nitrogen Free Extract ) contained in mango seeds can produce energy that exceeds Tegal duck energy necessity in age of 8 weeks. Excess energy is then converted into fat through a process of lipogenesis. The fat is then stored in the adipose tissue.

## References

- [1] Achmad Fadillah, dkk, 2008, *Pengembangan Produk Turunan Nangka Melalui Pemanfaatan Biji Nangka Sebagai Bahan Baku Varonyil (Variasi Roti Unyil) Yang Sehat*. Departemen Agribisnis. Bogor.
- [2] Anggorodi. R. 1979. *Ilmu Makanan Ternak Dasar Umum*. Gramedia. Jakarta.
- [3] Ishak, Elly dan Sarinah, Amrullah. 1995. *Ilmu dan Teknologi Pangan*. Badan Kerjasama Perguruan Tinggi Negeri Bagian Timur. Ujung Pandang.
- [4] NRC, 1994. *Nutrient Requirements for Poultry*. National Research Council, Washington D. C. USA.
- [5] Supriadi, Ir, 2011. *Panduan Lengkap Itik*. Penebar Swadaya. Jakarta.
- [6] Wahyu. 2005. *Nutrisi Ternak dan Unggas Konseptual*. Gadjah Mada University Press. Yogyakarta.



---

**Identification of Drug Related Problems in Congestive Heart  
Failure Patients in Panembahan Senopati Public Hospital During  
January to May 2015**

Pinasti Utami\*, Neng Rini Asih Yulianti

*Universitas Muhammadiyah Yogyakarta, Jl. Lingkar Selatan, Tamantirto, Bantul,  
Yogyakarta 55183, Indonesia*

---

**Abstract**

Congestive Heart Failure (CHF) is a progressive clinical syndrome caused by inability of the heart to pump sufficient blood to meet the body's metabolic needs. The treatment of CHF varies widely from patient to patient in order to cause the incidence of drug related problems (DRPs). Therefore, the necessary of DRPs identification to achieve patient's therapy outcome. The main aim of this research study was to determine the description of cardiovascular pharmacotherapy in patients with congestive heart failure as well as to determine the incidence of Drug Related Problems and to analyze the Drug Related Problems (DRPs).

This research was conducted by a non-experimental descriptive study with retrospective data collection of 20 medical record with CHF during January to May 2015, then the DRPs were analyzed using literature analysis, such as hospital standards of medical services, Pharmacotherapy Handbook 9<sup>th</sup> edition 2015, New York Heart Association (NYHA), Drug Interaction Facts (DIF), and Persatuan Kardiologis Indonesia (PERKI).

Based on this research study, there were 20 patients who had 42 DRPs. The DRPs consist of one adverse drug reaction (2.38%), 26 drug choice problems (61.90%), one drug use problems (2.38%), 14 drug interactions (33.33%), and no dosing problems were found.

Keywords: Congestive Heart Failure (CHF); Drug Related Problems (DRP); Panembahan Senopati Public Hospital; Inpatients; Cardiovascular pharmacotherapy.

---

**1. Introduction**

Heart failure is in the fourth rank out of the top 10 leading causes of death in Yogyakarta Special Province (Yogyakarta Health Office, 2013). Koshman et al (2008) explains that there were 1,977 patients in 11 RCT studies, including statistically significant 3 studies showing that the duration of heart failure inpatient would be prolonged if there is no pharmaceutical care.

Pharmaceutical care was conducted a pharmacist who has a role and function to identify Drug Related Problems (DRPs), overcomes actual DRPs which happen, and prevents potential DRPs (Adusumilli and Adepu, 2014).

Based on a research conducted by Hadiatussalamah (2013) related to DRPs in 143 patients with congestive heart failure, the result shows that the prevalence of DRPs incidence was 32.87% (47 patients). DRPs research which was also done by Endah (2014) in congestive heart failure patients with 26 cases (37.14%), there were 32 episodes of DRPs incidences. From these two studies, it can be seen that the percentage incidence of DRPs in patients with congestive heart failure is quite high, and almost every hospital estimated that the number is quite high. One of them is estimated to occur at Panembahan Senopati Bantul Hospital that is taken as the study site by researchers.

## **2. Material and Method**

### *2.1 Research Equipments*

The equipments used in the study are data collecting sheets, Pharmacotherapy Handbook 9th edition year 2015, books, journals, and other literatures related to congestive heart failure, drug related problems, medical service standards at Panembahan Senopati Bantul Hospital.

### *2.2 Population and Sample*

The population of the study was hospitalized patients diagnosed with CHF in Panembahan Senopati Bantul Hospital from January to May 2015. The samples are all patient in the population who had met the inclusion criteria.

### *2.3 Data analysis*

The data will be obtained and analyzed using descriptive non-experimental methods. The data include:

- An overview of patient's characteristics based on sex, age, comorbidities and inpatient duration.
- The data that had been collected, grouped, and numbered as well as the presented results presented.
- The calculations for the percentage of each of the DRPs identification done by counting the number of patients in each of the DRPs then divided by the total number of existing DRPs multiplied by 100% (Equation below).

$$\frac{\sum \text{each DRPs}}{\sum \text{overall incidence of DRPs}} \times 100\%$$

### 3. Results And Discussion

#### 3.1 Characteristics of the Patients Based on Sex

The characteristic of the patients based on gender is presented in Figure 1. There were incidents on women as with 45% (9 patients) and on men with 55% (11 patients) of total patients 100% (20 patients). It means that in this study the prevalence of CHF in women is lower than in men.

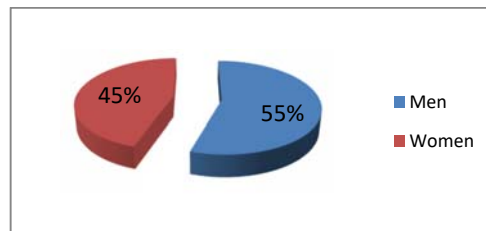

Figure 1. Characteristics based on sex

Based cohort study in the USA, 2-5 of 1000 people annually suffer from CHF, and CHF incidence in men is higher than in women (Bui et al., 2011).

#### 3.2 Characteristics of the Patients Based on Age

Based on age, among 20 patients becoming the respondents could be categorized in a varied age range (Figure 2), and the data were taken based on data from Data Center and Information of Health Ministry (2014).

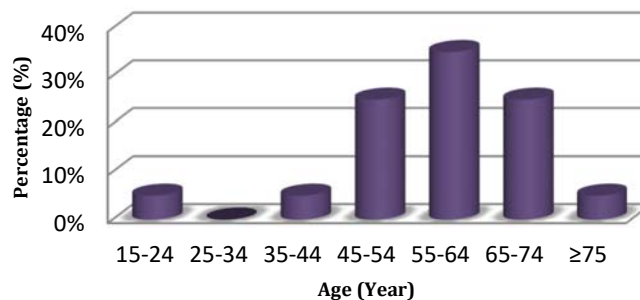

Figure 2. Characteristics based on age

The percentage obtained by Figure 2 shows that patients suffering from CHF were found in patients with the age range 45-54 years, age 55-64 and age 65-74 years. Based on the Framingham Heart Study, the incidence of heart failure is higher in the elderly (Bui et al., 2011). Most of the patients with CHF were in the age group of 65 years or more, while in the age group <65 increase from 23% to 29% (Hall et al, 2012)

### 3.3 Characteristics of the Patients Based on Morbidities

According to the table 1 it can be seen that the highest percentage on the group  $\geq 3$  comorbidities (50%), meaning that the risk of complications in patients with CHF is huge. The morbidities that become the most widely experienced by patients in this study were Ischemic Heart Disease (IHD) or Coronary Artery Disease (CAD). New England Journal of Medicine reported that in the last 20 years there were > 43 000 patients, and 65% among them suffered from CAD that becomes the main cause of heart failure based on 24 multicenter studies on heart failure therapy (Gheorghide et al., 2006).

Table 1. Characteristics of Morbidities

Number of Morbidities	Morbidities	Number of Patients	Percentage
1 Morbidities	Bronkopneumonia	1	5%
	Hypertension type II,	1	
	chest pain obstruction	1	
	SIRS, hipokalemia	1	
2 Morbidities	Atrial fibrilasis, Acute bronkhitis	1	45%
	IHD, atrial fibrilasis	1	
	IHD, bronkospasme	1	
	IHD, acute bronkhitis	1	
	IHD, atrial fibrilasis	1	
	IHD, gout arthritis	1	
	Cardiomegali, DM type II	1	
	Hypertension type II, hipoalbumin, DM type II	1	
	IHD, hipertension, DM	1	
	IHD, hepatitis A, hipertension, DM	1	
	IHD, vertigo, GERD	1	
$\geq 3$ Morbidities	Cardiomiopati, ca mammae IV, shock septis, DM type II	1	50%
	Cardiomegali, ca mammae IV, candidiasis oral	1	
	IHD, atrial fibrilasis, hyperurisemia, GERD	1	
	IHD, DM type II, obesity, renal failure ec nefropati, hipertension type II, ulcer	1	
	IHD, shock cardiogenic, migrain, candidiasis oral	1	
	IHD, dilipidemia, hyperurisemia	1	
<b>TOTAL</b>	<b>20</b>	<b>100%</b>	

### 3.4 Characteristics of the Patients Based Inpatient Duration

Patient characteristics based on Length of Stay (LOS) or inpatient duration in the study were classified into 2; those are LOS < 6 days and LOS  $\geq 6$  days. The percentage of

patients with Length of Stay <6 days was higher (55%) than in patients with length of stay  $\geq$  6 days (45%) (Table 2).

Table 2. Characteristics of the Patients Based on Length of Stay

Length of Stay	Total	Percentage
< 6 days	11	55%
$\geq$ 6 days	9	45%
<b>TOTAL</b>	<b>20</b>	<b>100%</b>

Bueno et al (2010) explains that during 2006, there were approximately 493,554 patients who were hospitalized with a diagnosis of heart failure that had been analyzed. The average length of stay (LOS) was for 6:33 days. The criteria that affect the length of stay of patients in the study varied widely, and the most significant one was the reduction or disappearance of dyspnea symptoms.

### 3.4 Identification of Drug Related Problems (DRPs)

DRP classifications used in this study followed the classification of PCNE (2006). The results of the study are presented in Table 3. Based on Table 3, DRPs choice drug problem was on the first place with the percentage 61.90% (26 incidents). Drug interaction was the second with a total percentage of 33.33% (14 incidents).

Table 3, DRPs choice drug problem

DRPs Classification	Explanation	Number of Incidence	Percentage
Adverse drug reaction (ADR) or unexpected reaction	Unexpected side effect (allergic or non-allergic) Experienced toxic effect	1	2.38%
Drug choice problem	Unsuitable indicated drugs. Unsuitable drug availability. Duplication on therapy group or active medicine. Contraindication drugs (on pregnant or breastfeeding). Non-therapy indication.	26	61.90%
Dosing problem	Lack drug dosage or unsuitable dosage regiment. Too high drug dosage or too often drug. Drug giving duration whether it has slow or fast response	-	-
Drug use problem	Drug provision mistake	1	2.38%
Drug interaction	Potential or actual interaction	14	33.33%
<b>TOTAL</b>		<b>42</b>	<b>100%</b>

#### 3.4.1 Adverse Drug Reactions

Adverse drug reactions or unexpected reactions happened in 1 incident; it was the use of captopril. Captopril is one of the drugs known as Angiotensin Converting Enzyme Inhibitors (ACEI) working on the track of Renin Angiotensin Aldosterone (RAA)

inhibiting the Angiotensin Converting Enzyme (ACE) and able to reduce cardiac remodeling. ACE inhibition is not only affecting the RAA lines but also influencing the inactivation lines of bradykinin (Ceconi et al., 2007). Inhibited bradykinin inactivation can lead to accumulation of bradykinin and stimulate chemoreceptors on the respiratory tract, consequently arises a sense of tingling and itching that leads to cough response (Golias et al., 2007).

### 3.4.2 Drug Choice Problem

Drug choice problem or the problem in the selection of drugs was found in all patients who became the subjects of the study. Each category of drug choice problem was found in the same patient. The results of the incidence of drug choice problem is presented in Table 4.

Table 4. Incidence Rate of DRPs on drug choice problem

Drug Problem	Choice	Explanation	Patient's Number	Numbers of Patient
Unsuitable indicated drug		Alloprinol, Furosemid	3	11
		Allopurinol, Ranitidin	8, 19	
		Allopurinol, Candistatin	13	
		Furosemid, Ranitidin	12, 20	
		Ranitidin, Cisplatin	18	
		Allopurinol	9	
		Furosemid Ranitidin	5, 6 16	
Non therapy indication		No digoksin provision	1, 2, 3, 6, 11, 13, 18, 19, 20	14
		Fever and Pain	4	
		DM and ca mammae stage IV	7	
		Cough with phlegm Hyperurisemia and cardiogenic shock	8, 12 14	
Duplication		Valsartan and Captopril	2	1

The findings of the drugs that did not follow the indication in this study (Table 4) was on the use of allopurinol. However, the laboratory results did not show increasing levels of uric acid (hyperuricemia). Provision of furosemide was not in accordance with the indication because the patient did not experience edema. Patients in this study did not show any indication that they had to get therapy with ranitidine (this drug is not appropriate with the indication). Candistatin (Nystatin) is also a drug that is not in accordance with the indications. Data from Alpha Diagnostic International (2011) mentions that candistatin is an antifungal that will be effective against candidiasis. The patient's diagnosis did not find candidiasis or other fungal infections. The next finding of drug choice problem was there was a patient complaining for the fever, but there was no drug given. Pain is also one of the main complaints of patients and had not been treated. In addition, other than dyspnea and edema, the symptoms experienced by patients with

CHF also the complaint of pain requiring palliative therapy (Adler et al., 2009). The findings indicated that there was no further therapy in patients with hyperuricemia. Larina et al. (2011) explained that there were 60% of CHF patients who were hospitalized experienced hyperuricemia as a result of cardiac decompensation. Therapy in patients with hyperuricaemia as a first-line of the drugs is the drug in the group of xanthine oxidase inhibitors such as allopurinol (Khanna et al, 2012). The findings showed duplication in the treatment group. Patients receiving valsartan and captopril can have increasing risk of hyperkalemia and hypotension if the medicines are given together (Tatro, 2010).

### 3.4.3 Drug Use Problems

Giving ceftriaxon was the contraindication for patients given treatment CaCO<sub>3</sub> and calcium polystyrene sulfonate. There is possibility of toxicity to the organs caused by the precipitation of calcium as well as the possibility of embolic events in patients receiving ceftriaxon, CaCO<sub>3</sub> dan calcium polystyrene sulfonate (Steadman, 2010).

### 3.4.4 Drug Interaction

Drug interactions become one of the issues that needed to be evaluated since the adverse effects can arise as the impact of it. The results of the incidence of drug interactions can be seen in Table 5.

Table 5. The Finding of drug interactions

Drug Interaction	Total of Patient	Information
Spirolakton+Valsartan	1	Significance: 1 Onset slow interaction Severe rate: mayor
Spirolakton+KSR	1	Significance: 1 Onset slow interaction Severe rate: mayor
Captopril+KSR	2	Significance: 4 Onset slow interaction, Severe rate n: moderate
Gentamisin+Furosemid	4	Significance: 1 Onset slow interaction Severe rate: mayor
Allopurinol+Captopril	8, 9, 10, 15, 18, 19	Significance: 4 Onset slow interaction Severe rate: mayor
Warfarin+Ceftriakson	9	Significance: 2 Onset slow interaction, Severe rate: moderate
Digoksin+Omeprazol	10	Significance: 4 Onset slow interaction, Severe rate: moderate
Aspirin+Clopidogrel	17	Significance: 1 Onset slow interaction Severe rate: mayor
Warfarin+Allopurinol	10	Significance: 4 Onset slow interaction, Severe rate: moderate

The first finding of drug interactions is that patients received spironolactone therapy, valsartan therapy and potassium chloride therapy (Table 5). It happens because spironolactone can increase the levels of potassium serum with the mechanism of action as a non-selective antagonist aldosterone. The risk of hyperkalemia also increased by the use of valsartan. Other drug interaction was found in patients receiving furosemide and gentamicin. Xia (2013) also explained that there were 17 mice experienced impaired hearing after being given combination of gentamicin and furosemide, and only 16 mice could survive. Drug interaction was also seen in some patients receiving allopurinol and captopril. Tatro (2010) in the book of Drug Interaction Facts explained that interaction between allopurinol and captopril should be monitored toward hypersensitivity reactions in patients, but it is not certain about the mechanism of interaction. The use of ceftriaxone and warfarin also became the part of drug interactions. Baillargeon et al (2012) explained that the administration of antibiotics, which one of them is the group of sefalosforin, can increase the risk of bleeding in most patients who also receive warfarin therapy. Drug interaction was also found on digoxin therapy and omeprazole. The use of digoxin altogether with omeprazole may increase the absorption of digoxin itself caused by the working mechanism of omeprazole as a proton pump inhibitor (Lahner et al., 2009). The next drug interaction was in the patients receiving aspirin and clopidogrel. McQuaid and Laine (2006) based on meta analysis explained that the risk of gastrointestinal bleeding increases in the provision of low-dose aspirin and clopidogrel simultaneously.

### **Conclusion**

Based on data of the research and the discussion identification of DRPs in patients diagnosed with Congestive Heart Failure (CHF) at inpatient ward of Panembahan Senopati Bantul Hospital January to May 2015 period, it can be concluded that the total incidence of DRPs were 20 patients with the main diagnosis of CHF becoming inpatient at Panembahan Senopati Bantul Hospital during January to May 2015 period with 42 events consisting of adverse drug reaction (ADR) or unexpected reactions with 1 occurrence (2:38%), drug choice problem with 26 events (61.90% ), dosing problems with no occurrence, drug use problems with 1 occurrence (2:38%) and drug interaction with 14 incidences (33.33%).

### **Acknowledgment**

The financial support to the author from Universitas Muhammadiyah Yogyakarta is highly acknowledged.



## References

- Adler, E.D., Goldfinger, J.Z., Kalman, J., Park, M.E., Meier, D.E. (2009). Palliative Care in the Treatment of Advanced Heart Failure. American Heart Association. 120, 2597-2606 [pdf]. Last Accessed 25 Mei 2016. <http://www.circ.ahajournals.org/>
- Adusumilli, P.K & Adepu, R. (2014). Drug Related Problems : an overview of various classifications system. Asian J Pharm Clin Res, 07, 0974-2441. Last Accessed 09 Juni 2015. <http://innovareacademics.in/journals/index.php/ajpcr/article>
- Alpha Diagnostic International.(2011). Product Data Sheet: Nystatin, Woodlake Center, USA
- Baillargeon, J., Holmes, H.M., Lin, Y., Raji, A.M., Sharma, G., et al.(2012). Concurrent Use of Warfarin and Antibiotics and the Risk of Bleeding in Older Adults, The American Journal of Medicine, 02-125, 183-189 [pdf]. Last Accessed 26 Mei 2016. [www.ncbi.nlm.nih.gov/pmc/article](http://www.ncbi.nlm.nih.gov/pmc/article)
- Bueno, H., Ross, J., Wang, Y., et al.(2010). Trends in Length of Stay and Short-term Outcomes Among Medicare Patient Hospitalized for Heart Failure, 1993-2006. JAMA, 21, 303 [pdf]. Last Accessed 07 Mei 2016. <http://www.archophth.jamanetwork.com/>
- Bui, A., Tamara, B., Horwich, F., Fonarow, G.,(2011)Epidemiology and risk profile Heart Failure, 8, 30-41, 10.1038. Last Accessed 05 Mei 2016. [www.ncbi.nlm.nih.gov/pmc/articles/PMC3033496/](http://www.ncbi.nlm.nih.gov/pmc/articles/PMC3033496/)
- Cecconi, C., Francolini, G., Olivares, A., Comini, L., Bachetti, T., Ferrari, R.(2007) AngiotensinConverting Enzyme (ACE) Inhibitors have Different Selectivity for Bradykinin Binding Sites of Human Somatic ACE Abstract, European Journal of Pharmacology, 01-03-577, 01-06. Last Accessed 25 April 2016.
- Endah, N.S.(2014) Identifikasi Identification of Drug Related Problems in Congestive Heart Failure Patients in OKU Bantul Muhammadiyah Hospital Thesis. . Universitas Muhammadiyah Yogyakarta, Yogyakarta.
- Health Department Special Region of Yogyakarta.(2013).Profil Kesehatan Daerah Istimewa Yogyakarta.Yogyakarta.
- Gheorghade, M., Sopko, G., Luca, L.D., Velazquez, E.J., Parker, J.D., et al.(2006). Navigating the Crossroads of Coronary Artery Disease and Heart Failure, Circulation AHA, 106.623199 [pdf]. Last Accessed 07 Mei 2016. <http://www.circ.ahajournals.org/content/114/11/1202.full>
- Golias, Ch., Charalabopoulos, A., Stagikas, D., Charalabopoulos, K., Batistatou, A.(2007). The Kinin System-Bradykinin: Biological Effects and Clinical Implications. Multiple Role of the Kinin SystemBradykinin, Hippokratia, 03, 124- 128 [pdf]. Last Accessed 25 April 2016. [www.ncbi.nlm.nih.gov/pmc/articles/PMC2658795/pdf/hippokratia-11-124.pdf](http://www.ncbi.nlm.nih.gov/pmc/articles/PMC2658795/pdf/hippokratia-11-124.pdf)
- Hadiatussalamah. (2013). Identifikasi Identification of Drug Related Problems in Congestive Heart Failure Patients in Dr. Mohammad Hoesin Palembang Public Hospital. Thesis., Universitas Gadjah Mada, Yogyakarta
- Hall, M.J., Levant, S., DeFranches, C.J.(2012). Hospitalization for Congestive Heart Failure : United States, 2000-2010, NCHS data brief, 108 [pdf]. Last Accessed 16 Mei 2015, [http://www.cdc.gov/nchs/data/data\\_briefs/db108.pdf](http://www.cdc.gov/nchs/data/data_briefs/db108.pdf)
- Koshman, S.L., Charrois, T.L., Simpson, S.H., McAlister, F.A., Tsuyuki, R.T.( 2008). Pharmacist Care of Patients with Heart Failure : A Systematic Review of Randomized Trials, American Medical Association, 07-168 [pdf]. Last Accessed 13 Juni 2016, <http://www.archpsyc.jamanetwork.com/>
- Lahner, E., Annibale, B., Fave, D.G.(2009). Systematic Review: Impaired Drug Absorption Related to the Co-Administration of Antisecretory Therapy Abstract, Alimentary Pharmacology and Therapeutics, 12-29, 1219-1229. Last Accessed 25 Mei 2016, <http://onlinelibrary.wiley.com/doi/10.1111/j.13652036.2009.03993.x/> abstract
- Larina, V.N., Bla, B., Brodskii, M.S., 2011, Hyperuricemia in Chronic Heart Failure Abstract, Kardiologia, 03-51, 68-73. Last Accessed 25 Mei 2016, [www.ncbi.nlm.nih.gov/pubmed/21627617](http://www.ncbi.nlm.nih.gov/pubmed/21627617)
- Pharmaceutical Care Network Europe Foundation.(2006).PCNE Classification for Drug related problems V5.01.[pdf]. Last Accessed 16 Mei 2015, [www.pcne.org/workinggroups/2/drug-related-problems](http://www.pcne.org/workinggroups/2/drug-related-problems)
- Steadman, E., Raisch, D.W., Bennett, C.L., Esterly, J.S., Becker, T., Postelnick, M., et al.(2010). Evaluation of a Potential Clinical Interaction Between Ceftriaxone and Calcium, American Society for Microbiology, 04-54, 101128 [pdf]. Last Accessed 26 Mei 2016, [www.ncbi.nlm.nih.gov/pmc/articles/PMC2849391/pdf/1111-09.pdf](http://www.ncbi.nlm.nih.gov/pmc/articles/PMC2849391/pdf/1111-09.pdf)
- Tatro, D.S.(2010). Drug Interaction Facts TM . Wolters Kluwer Health. USA.
- Wells, B.G., Dipiro, J.T., Schwinghammer, T.L., & Dipiro, C.V.(2015). Pharmacotherapy Handbook (9th ed) : Heart Failure, 75-81, MC Graw Hill Education.

---

## **Actual and Potential Drug Related Problems in Diabetic Patients through Medication Reconciliation Process**

Nurul Maziyyah\*, Gresti Ilma Rosa, Rizky Rezanawanti Muchtar

*School of Pharmacy, Universitas Muhammadiyah Yogyakarta, Special District of  
Yogyakarta 55183, Indonesia*

---

### **Abstract**

Diabetes Mellitus (DM) is one of the chronic diseases related to many kinds of drug related problems (DRPs). Being a part of the healthcare team, pharmacist should be of concern for DRPs, especially those which give harm to the patients and interfere with the goal of therapy. Medication reconciliation is an effort that can be used by pharmacist to identify, avoid, and give solution to DRPs. This research aims to identify potential and actual DRPs in diabetic patients through medication reconciliation process.

This research used a non-experimental design where the researcher intends to give a description on DRPs identified through medication reconciliation process. Sample in the study were type 2 DM patients who gave a visit to a Primary healthcare centre in Bantul, Yogyakarta during August – December 2015. Medication reconciliation process was conducted by gaining complete information of drugs/herbs/supplements that were routinely consumed by the patients and comparing it with newly prescribed drugs at the time of visit. Actual and potential DRPs were identified based on the result of comparison and evaluation of patients' drugs/herbs/supplements consumption.

A number of 35 type 2 DM patients were included in this research. Result showed that 82.86 % of patients were identified with actual and/or potential DRPs. Actual DRPs identified were in adherence (39.39%) and adverse drug reaction (9.09%), while potential DRPs identified were adverse drug reaction (15.15%) and drug interactions (36.36%). Medication reconciliation resulted in more complete information useful to identify DRPs.

### **Keywords**

*drug related problems; diabetes mellitus; medication reconciliation*

---

## **1. Introduction**

Diabetes Mellitus (DM) is one of the chronic diseases with a high prevalence in the world including Indonesia. The number of DM patients worldwide in 2014 reached 422 million adults which showed a 2-fold increase from 1980 (WHO, 2016). Indonesia itself had a number of 8.4 million diabetes which is predicted to give almost a 3-fold increase in 2030 (Perkeni, 2011). As in 2013, the Basic Health Research done in

---

\* Corresponding author. Tel.: +62 877 3817 4828.

E-mail address: [maziyyahnurul@yahoo.com](mailto:maziyyahnurul@yahoo.com); [maziyyahnurul@umy.ac.id](mailto:maziyyahnurul@umy.ac.id)

Indonesia revealed a 2.1% increase in prevalency of DM compared to 1.1% increase in 2007 (Kemenkes, 2013).

A high prevalence in DM is associated with a high incidence of Drug Related Problems (DRPs) among diabetic patients. A study on Type 2 DM patients in a tertiary hospital in Malaysia resulted in 406 DRPs where 91.8% had at least one DRP occurring with potential drug-drug interaction as the most frequent DRP, while another study in Nigeria found that there was an average of 2.1 DRPs occurring in 399 diabetic patients with non-adherence as the main problem (Huri and Ling, 2013; Ogbonna et al, 2014). A different pattern can be seen in Indonesian hospitals where the common DRPs in diabetes patients were mostly over dosage and drug-drug interaction (Wahyuni, 2013; Sari, 2015; Marbun, 2016).

The common use of complementary and alternative medicines such as traditional herbs can also be related to DRPs in diabetic patients. A national survey showed an increase in herb usage among Indonesian people for the intention of self medication (Supardi, 2003). Drug interaction was the most commonly DRPs that is associated with CAMs usage. A number of 882 drug – CAMs interaction had been identified where around 240 of them were interactions with major significancy (Tsai et al, 2012).

Identification of DRPs as one of the main activities of a pharmacist have gone through various inovation in order to provide an effective way for pharmacist to conduct this activity. Medication reconciliation is one of the attempt to identify and prevent DRPs by gathering important information of drug usage which eventually could prevent medication errors (Barnsteiner, 2008). This study was conducted to identify actual and potential DRPs that occur in diabetes patients having their routine visit to the Primary Healthcare center.

## **2. Material and Methods**

### *2.1. Study design*

This study was conducted through an observational or non-experimental design. Patients meeting the inclusion criteria entered the medication reconciliation process where the researcher obtained thorough information regarding medication history and other complementary and alternative medicines (CAMs) through deep interview with the patients. Medication reconciliation was then conducted by comparing medication information from patients with the newly prescribed medication given by the doctor from their visit to identify any drug related problems.

### *2.2. Study time and location*

This study was conducted in a Primary Healthcare Center in Bantul Region, Special District of Yogyakarta, Indonesia where DM patients in the surrounding area usually do routine visit to the primary care doctor and obtain their medication monthly. The study period was from August to December 2015.

### 2.3. Patient selection

Patients recruited for this study had to meet the inclusion criteria determined by the researcher as follows: patients above 18 years old, agree to be a research subject (by fulfillment of inform consent), diagnosed with type 2 DM for a minimum of 5 years. Patients were excluded if they didn't know or could not describe the type of medication or CAMs routinely consumed at home.

### 2.4. Data analysis

Identification of drug related problems was done by comparing and analyzing both medication list from the interview process and newly prescribed medication by the doctor. Identified DRPs was then classified according to types of DRPs which consist of actual and potential DRPs. Actual DRPs was determined as DRPs which occurred in the study period while potential DRPs were problems that were identified through literature trace but had not yet happen to the patient in the study period. Each type of DRPs was analyzed to gain result on major DRPs happening in type 2 DM patients.

## 3. Results and Discussion

### 3.1. Patient characteristics

Patients recruited in this study were 35 type 2 DM patients who met the inclusion criteria. Table 1 describes the characteristics of patients in this study.

Table 1. Patients Characteristic Distribution

Characteristic	Description	Percentage
Gender	Male	31.43%
	Female	68.57%
Age	40 – 50 years old	14.29%
	51 – 65 years old	20%
	>65 years old	65.71%
Co-morbids	Hypertension	76.93%
	Dyslipidemia	7.69%
	Hypertension + Dyslipidemia	7.69%
	Hypertension + Hyperuricaemia	7.69%

Based on the gender, patients in this study were mostly female (68.57%). This picture in line with the result from the National Basic Health Research in Indonesia in the year 2013 where there was an increase in the number of female DM patients compared with male patients (Kemenkes, 2013). The difference in men and women regarding the risk to obtain diabetes is usually caused by several factors such as difference in body composition, insulin resistance and blood glucose level which could be influenced by sex hormones (Geer and Shen, 2009).

Age is one of the factors contributing in the prevalence of DM. Aging has been associated with the risk of insulin resistance which could be the result of organ dysfunction, commonly seen in late adults (Barbieri et al, 2001). The result from Table 1 indicates that most of the patients subjected in this study were above 65 years old. For

the process of medication reconciliation, this result could become a disadvantage because difficulty in interviewing these kind of patients, moreover language barriers was also seen during the process (most elderly patients in Java are used to speaking in Javanese).

Looking at the result related to the co-morbidities of the patients, patients were mostly diagnosed with diabetes and hypertension (76.93%). This is a common finding in the society. The relationship between diabetes and hypertension can be associated with the overlapping on pathophysiology of both diseases which is usually related with obesity, inflammation, oxidative stress and insulin resistance (Cheung and Li, 2012).

### 3.2. Drug usage pattern

Drug related problems can often be seen through the pattern of drug usage in patients, regarding the number of drugs consumed by the patients. Drug interaction is one of the most common DRP that can be recognized by knowing the amount of drugs prescribed or consumed by patients which is not rarely found in diabetes patients (Smith et al, 1969; Grant et al, 2003). Drug usage pattern in our subjects can be seen in Table 2.

Table 2. Drug Combination

Drug Combination	No. of Patients (%)
Single Drug	-
2 - combination drugs	7 (20%)
3 - combination drugs	15 (42.86%)
4 - combination drugs	11 (31.43%)
5 - combination drugs	2 (5.71%)
Total	35 (100%)

This study showed that drug usage pattern in diabetes patients was dominated with 3 to 4 drug combination which could consist of anti diabetic or/and non-anti diabetic drugs. This result is similar to several studies conducted in United States and Southern India which revealed an average of 4.1 and 4.77 drugs combined in diabetic and diabetic hypertension patients respectively (Grant et al, 2003; Hussain et al, 2014). The use of many drug combinations must be a concern to avoid the risk of adverse drug reaction.

The consumption of complementary and alternative medicines was also seen in 4 of the subjects. These CAMs consisted of the following as described in Figure 1.

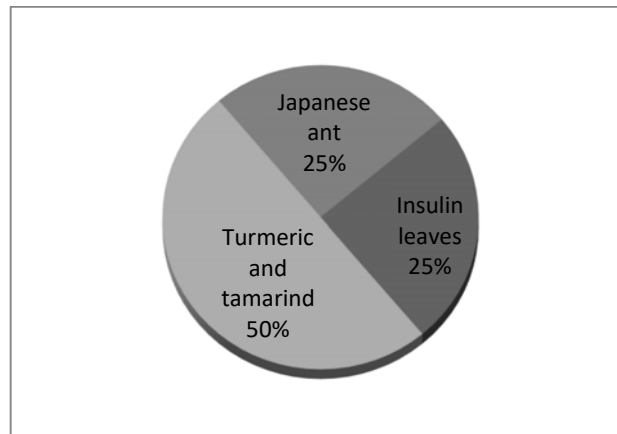

Figure 1. Use of CAMs

There were only few subjects in this study (4 out of 35 patients) who routinely consume CAMs besides their prescribed drugs. Based on the interview with all 35 patients, most of them have already stopped their CAMs consumption when they were diagnosed with diabetes and also had been told by the doctor to stop their CAMs.

Insulin leaves is also known as Yakon leaves (*Smallanthus sonchifolius*) which is originated from Andes mountains. This herb is usually used as a traditional medicine in Peru. Boiled insulin leaves have shown benefit for diabetes condition for its ability to give effective glycemic control although has not yet been clinically tested (Lachman et al, 2003; Serra-Barcelona et al, 2014). Another 2 patients in this study consumed a combination of turmeric and tamarind decoction which is widely consumed by Indonesian people for centuries. This mixture is commonly used for dysmenorrhoea and has also been studied for its antioxidant effect as well as other beneficial effects (Melin and Soleha, 2016; Mulyani, 2014). The effect of curcumin (active compound in turmeric) on blood glucose level has been studied in a systematic review and resulted in confirmation on its role in prevention and treatment for diabetes and associated disorders based on animal model research. Unfortunately, there is still few clinical trials related to this subject (Zhang et al, 2013).

The use of Japanese ant was seen in only 1 patients in this study by inserting the ant in a capsule. Japanese ant or *Tenebrio molitor* is recently being popular in Indonesian people for the treatment of diabetes. The effect of this insect on hyperglycemic condition had been studied by Fauzi et al (2016) which revealed this insect's potential as an antidiabetic agent.

### 3.3. Drug related problems

Drug related problems resulted from the process of medication reconciliation in diabetes patients were classified into actual and potential DRPs. From a total of 35 subjects, we found 33 cases of DRPs (actual and potential) in 29 patients (82.86%) which is detailed in Table 3.

Table 3. Identified Drug-Related Problems

Drug-Related Problems	DRP Type	No. of cases (%)
Inadherence	Actual	13 (39.39%)
Adverse drug reaction	Actual & Potential	8 (24.24%)
Drug Interaction	Potential	12 (36.36%)
Total		33 (100%)

This study revealed that most of diabetic patients in the Primary Healthcare Center did not comply in consuming medication. By conducting medication reconciliation, we were able to gather information on how the patient consume their medication in order to identify any sign of inadherence.

### 3.3.1. Inadherence

Inadherence is one of the DRPs commonly seen in chronic disease patients because of long life consumption of medication. Inadherence can be caused by lack of information given by the healthcare provider on how to consume the medication or internal factors from the patient such as burden in routine consumption, misbelief in medication, etc. Most of the patients in the study was inadhere by not routinely consuming the antidiabetic medication such as metformin and glybenclamide. The importance of adherence in diabetes patients was studied by Yu et al (2010) which concluded that medication adherence may reduce the risk for microvasculare complications in diabetic patients. Disease and medication beliefs were known as significant predictors for inadherence (Mann et al, 2009) which was also seen in patients from our study. These factors are modifiable and should be a concern for healthcare providers in order to improve patients' adherence.

### 3.3.2. Adverse drug reaction

Based on thorough interview in the medication reconciliation process, this study was able to identify several adverse drug reaction (ADR) that occurred as actual ADR and potential ADR. Figure 2 shows medication which contributed to these ADRs.

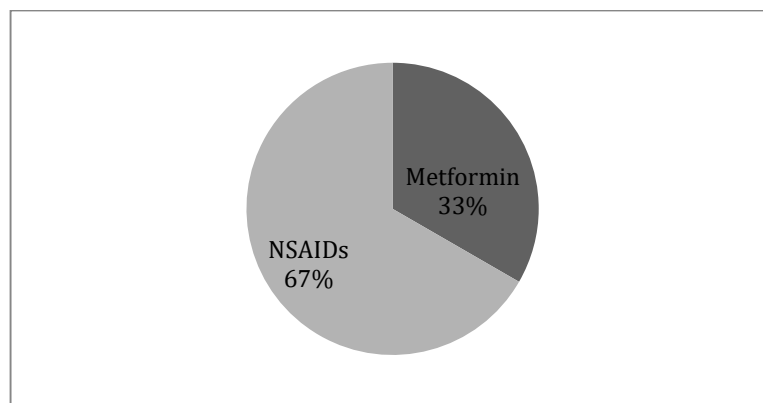

Figure 2. Drugs contributing to adverse drug reaction

Identification of ADRs in diabetes patients in this study was dominated by potential ADRs from the use of Non-Steroid Antiinflammatory Drugs (NSAIDs). The

determination as potential ADR was due to routine use of NSAIDs in the patients. Patients were prescribed with NSAIDs as analgetics to reduce pain caused by post surgery or pain in foot or joint. The routine use of NSAIDs has been known to give risk on gastrointestinal irritation which could lead to gastrointestinal bleeding (Becker, 2004). While actual ADR was seen in patients consuming metformin resulting in minor side effects such as nausea and diarrhea.

### 3.3.3. Potential drug interaction

Medication reconciliation conducted to diabetes patients in this study resulted in several potential drug interaction which did not only include drug – drug interaction, but also drug – CAM interaction. Table 4 describes the interaction identified from the study.

Table 4. Potential drug interaction

Interaction type	Interacting drugs	No. of cases	Percentage
Minor	Hydrochlorothiazide + glimepiride	1	41,67%
	Furosemide + metformin	1	
	Nifedipine + metformin	1	
	Metformin + turmeric-tamarind	2	
Moderate	Diclofenac + glimepiride	3	50%
	Diclofenac + glibenclamide	1	
	Antacid + glibenclamide	1	
	Glibenclamide + simvastatin	1	
Major	Amlodipine + simvastatin	1	8,33%
		12	100%

Potential drug interaction identified from the patients was mostly classified as minor and moderate interaction which usually don't give fatal effect for the patients although still need consideration based on each type of interaction. Drug interaction with major significance based on Tatro et al (2006) was the interaction between amlodipine and simvastatin which was seen in 1 patient. The effect of this interaction increased the risk of toxicity from simvastatin such as miopathy and rhabdomyolysis and must be monitored closely (Nishio et al, 2005).

Potential interaction with CAMs was found in 2 patients consuming turmeric and tamarind mixture drink with routine use of metformin. The hypoglycemic effect of curcumin in turmeric (as discussed above) should be a concern and patients should be educated to have their blood glucose routinely monitored to avoid hypoglycemia as well as understanding the symptoms and what to do in case of hypoglycemia.

Through medication reconciliation process, the study was able to identify several actual and potential DRPs occurring in diabetes mellitus patients having their routine visit to the Primary Healthcare Center such as in adherence, adverse drug reactions and also drug interactions. The deep interview in the beginning has led to a more comprehensive understanding on how patients consume their medication and also



CAMs usage other than prescribed drugs which contribute to a better way on identifying DRPs compared to the usual visit in a Primary Healthcare Center.

### Acknowledgement

This research was funded by the research grant from Universitas Muhammadiyah Yogyakarta, Indonesia.

### References

- Barbieri, M., Rizzo, M.R., Manzella, O., Paolisso, G. (2001). Age-related Insulin Resistance : Is It an Obligatory Finding?. *Diabetes Metab Res Rev*, Vol. 17, No. 1: 19-26.
- Barnsteiner, JH. (2008). Medication Reconciliation. In Hughes, R.G.. *Patient Safety and Quality: An Evidence-Based Handbook for Nurses Vol 2*, AHRQ Publication, Rockville, MD.
- Becker, J.C., Domschke, W., Pohle, T. (2004). Current Approaches to Prevent NSAID-induced Gastropathy- COX selectivity and beyond. *Br J Clin Pharmacol*, Vol. 58, No. 6: 587-600.
- Cheung BM and Li Chao. (2012). Diabetes and Hypertension: Is There a Common Metabolic Pathway?. *Curr Atheroscler Rep*, Vol 14: 160-166.
- Fauzi MARD, Shah DYF, Pratama A, Widyapuspa AH, Supriyanto G. (2016). Dose Determination of *Tenebrio molitor* (Mealworm) Extract as an Anti-Diabetic Agent. *International Journal of Biomedical and Biological Engineering*, Vol. 3, No. 5.
- Geer EB and Shen W. (2009). Gender Differences in Insulin Resistance, Body Composition and Energy Balance. *Gend Med*, Vol. 6, Suppl 1: 60-75.
- Grant RW, Devita NG, Singer DE, Meigs JB. (2003). Polypharmacy and Medication Adherence in Patients with Type 2 Diabetes. *Diabetes Care*, Vol. 26: 1408-1412.
- Huri HZ and Ling LC. (2013). Drug-related Problems in Type 2 Diabetes Mellitus Patients with Dyslipidemia. *BMC Public Health*, Vol 13, No 1192.
- Hussain Z, Sana A, Mohammed S, Razzaq MA. (2014). Patterns of Drug Therapy Among Diabetic Hypertensive Patients with Other Complications. *Int J Pharm Pharm Sci*, Vol. 6, No. 6:270-277.
- Kementrian Kesehatan (Kemenkes) RI. (2013). *Riset Kesehatan Dasar*, Department of Research and Health Development, Indonesian Ministry of Health, Jakarta.
- Lachman J, Fernandez EC, Orzak M. (2003). Yacon [*Smallanthus sonchifolia* (Poepp. et Endl.) H. Robinson] Chemical Composition And Use – A Review. *Plant Soil Environ*, Vol 49, No 6: 283-290.
- Mann DM, Ponienman D, Leventhal H, Halm EA. (2009). Predictors of Adherence to Diabetes Medications: The Role of Disease and Medication Beliefs. *J Behav Med*, Vol. 32: 278-284.
- Marbun LK. (2016). Identifikasi Drug-related Problems (DRPs) pada Pasien Diabetes Mellitus Tipe 2 dengan Komplikasi di Rumah Sakit Umum Pusat H. Adam Malik. Thesis, Universitas Sumatra Utara, Medan.
- Melin UN and Soleha TU. (2016). Manfaat Kunyit Asam (*Curcuma domestika val.*) terhadap Dismenore. *Majority*, Vol. 5, No. 1: 129-133.
- Mulyani S, Harsojuwono BA, Puspawati GAKD. (2014). The Potency of Kunyit Asam Beverage (*Curcuma domestica Val.* -*Tamarindus indicaL.*) as A Rich-Antioxidant Drink. *Agritech*, Vol. 34, No. 1: 65-71.
- Nishio, S., Watanabe, H., Kosuge, K., Uchida, S., Hayashi, H., Ohashi, K. (2005). Interaction between Amlodipine and Simvastatin in Patients with Hypercholesterolemia and Hypertension. *Hypertens Res*, Vol. 28, No. 3: 223-227.

- Ogbonna BO, Ezenduka CC, Opara CA, Ahara LG, (2014). Drug Therapy Problems in Patients with Type 2 Diabetes in a Tertiary Hospital in Nigeria. *International Journal of Innovative Research & Development*, Vol. 3, Issue 1: 494-502.
- Perkumpulan Endokrinologi Indonesia (Perkeni). (2011). *Konsensus Pengelolaan Diabetes Mellitus Tipe 2 di Indonesia*, Perkeni, Jakarta.
- Sari IN. (2015). *Evaluasi Drug-related Problems Obat Antidiabetes Pada Pasien Geriatri dengan Diabetes Mellitus Tipe 2 di Ruang Rawat Inap Rumah Sakit Umum Pelabuhan Periode Januari-Juni 2014*. Thesis, UIN Syarif Hidayatullah, Jakarta.
- Serra-Barcelona C, Coll Araoz MV, Cabrera WM, Habib NC, Honore SM, Catalan CA et al. (2014). *Smallanthus macroscyphus: A New Source of Antidiabetic Compounds*. *Chem Biol Interact*, Vol. 25, No 209: 35-47.
- Smith JW, Seidl LG, Cluff LE. (1969). *Studies On The Epidemiology Of Adverse Drug Reactions*. V. Clinical factors influencing susceptibility. *Ann Intern Med*, Vol 65, No. 4: 629-640.
- Supardi S, Nurhadiyanto F, Eng SW. (2003). *Penggunaan Obat Tradisional Buatan Pabrik dalam Pengobatan Sendiri di Indonesia*. *Jurnal Bahan Alam Indonesia*, Vol 2, No. 4: 136-41.
- Tatro, D.S. (2006). *Drug Interaction Facts*. Lippincot William and Wilkins, Philadelphia.
- Tsai HH, Lin HW, Simon Pickard A, Tsai HY, Mahady GB. (2012). *Evaluation of Documented Drug Interactions and Contraindications Associated with Herbs and Dietary Supplements: A Systematic Literature Review*. *Int J Clin Pract*, Vol 66, No.11:1056-1078.
- Wahyuni, ST. (2013). *Identifikasi Drug Related Problems pada Pasien Rawat Inap Diabetes Melitus Tipe 2 dengan Komplikasi Ulkus Diabetik di Rumah Sakit PKU Muhammadiyah Yogyakarta Tahun 2012*. Thesis, Universitas Gadjah Mada, Yogyakarta.
- World Health Organization (WHO). (2016). *Global Report on Diabetes*, WHO Press, Geneva.
- Yu AP, Yu YF, Nichol MB. (2010). *Estimating the Effect of Medication Adherence on Health Outcomes among Patients with Type 2 Diabetes - An Application of Marginal Structural Models*. *Value in Health*, Vol. 13, No. 8: 1038-1045.
- Zhang DW, Fu M, Gao SH, Liu JL. (2013). *Curcumin and Diabetes: A Systemic Review*. *Evidence-Based Complimentary and Alternative Medicine*, Vol 2013, Hindawi Publishing Corporation.

---

**Analysis on The Influence of Early Pharmaceutical Exposure in  
Primary Health Care on Student's Knowledge Levels in School of  
Pharmacy Universitas Muhammadiyah Yogyakarta**

Ingenida Hadning<sup>a</sup>, Ayutya Bastian Firza<sup>a</sup>

*<sup>a</sup>School of Pharmacy Faculty of Medicine and Health Sciences Universitas Muhammadiyah  
Yogyakarta, Tamantirto Kasihan Bantul, Yogyakarta 55183, Indonesia*

---

**Abstract**

Early Pharmaceutical Exposure (EPhe) program is a practicum activity for undergraduate pharmacy students of School of Pharmacy Universitas Muhammadiyah Yogyakarta (UMY) in the pharmaceutical fields. One of those pharmaceutical fields is primary health care. UMY is the only school of pharmacy in Indonesia that applies this program. It will be a consideration that can be applied in the other universities in Indonesia. The main objective of this research is to determine the influence of EPhe program on student's knowledge levels after conducting the EPhe program.

This research study was conducted by an observational descriptive analytic method with cross sectional approaches. The sampling technique used was a non-probability sampling through purposive sampling. The samples in this study were undergraduate pharmacy students of the School of Pharmacy UMY year 2015. The samples of this study were 30 respondents. They were given questionnaires to evaluate student's knowledge level pre and post the program. The data obtained were tested using the Wilcoxon test.

The result of this research showed that the student's knowledge levels for pre implementation of EPhe were Good (50%), Sufficient (46,67%), and Less (3,34%). In post implementation of EPhe program, the student's knowledge levels increased showing Good (90%) and Sufficient (10%). The Wilcoxon test indicated that p value = 0.000, which means that the result was significantly different in the scores of student's knowledge levels for both pre and post EPhe implementations. The research concludes that the EPhe program influenced the student's knowledge levels.

**Keywords**

*Early Pharmaceutical Exposure; primary health care; knowledge levels*

---

**Introduction**

Good pharmaceutical practice should be carried out by a competent pharmacist. Competent pharmacists who are qualified in accordance with Indonesian Pharmacist Competence Standard can be produced through appropriate curriculum and learning processes. A Competency Based Curriculum (CBC) has been implemented in Indonesia. It is expected that School of Pharmacy graduates have met the competence required to become a pharmacist through the Competency Based Curriculum. The Competency Based Curriculum can be implemented in various learning

processes. School of Pharmacy in the Muhammadiyah University Yogyakarta (UMY) uses a Problem Based Learning (PBL) learning process. PBL applies student centered learning methods (Indonesian Pharmacist Association, 2011; Ministry of Health Republic of Indonesia, 2009; Nursalam, 2008).

PBL is a learning method that gives the ability to learners through problem solving. PBL main objective is to provide skills and information to students regarding problems that may be encountered when carrying out their profession later (Nursalam, 2008). This PBL methods are implemented on expert lectures, tutorials, lab, skill lab, plenary discussions, Interprofessional Education (IPE), and the Pharmaceutical Early Exposure (EPhe) activities in the School of Pharmacy UMY. School of Pharmacy UMY becomes the only School of Pharmacy in Indonesia to implement the EPhe learning method (School of Pharmacy UMY, 2015).

EPhe is a form of clinical practice for the students in School of Pharmacy undergraduate degree program in a real pharmaceutical occupation setting. EPhe is delivered to prepare the students to be able to know the works of a pharmacist in the field of pharmacy as early as possible. EPhe activities are expected to stimulate curiosity and enhance students' learning spirit in a variety of pharmaceutical sciences to be applied in pharmaceutical profession (School of Pharmacy UMY, 2016). The researchers sought to know the effect of EPhe implementation towards the knowledge level of students in School of Pharmacy UMY. Researchers focused the study on the implementation of EPhe on primary health care.

### **Research Method and Material**

This research is a descriptive analytic observational research using cross sectional approach. It used a questionnaire to determine the effect of EPhe implementation in primary health care on students' knowledge level in the School of Pharmacy UMY. This research was conducted in the School of Pharmacy UMY from April to May 2016.

The sampling technique used in this research was a non-probability sample using purposive sampling. The samples in this research were students of the School of Pharmacy UMY class of 2015 who had taken EPhe class in primary health care and they were amounted to 30 people. The samples represent each primary health care and its session implementation.

This research used a questionnaire as its instrument. The questionnaire was designed by the researchers to refer to the EPhe manual in primary health care. Knowledge level questionnaire consists of 31 questions which then measured by Guttman scale, a scale that is both firm and consistent by giving a straight answer to the question. The form of the questions from the questionnaire are in the form of yes or no question. Each correct answer was given a value of 1 and each wrong answer was given a value of 0 (Hidayat, 2007).

The study was initiated with reliability and validity tests to the research instruments. The valid and reliable questionnaire were distributed to the respondents who previously given the information on the purpose and objective of the study by researchers in advance. After being given an explanation, respondents signed an agreement letter confirming to be the respondent. Respondents filled out a questionnaire by giving a check on the appropriate answer.

The researcher conducted a univariate analysis to the data obtained in order to describe the frequency distribution of the researched variables descriptively. Univariate analysis aims to explain or describe the characteristics of each study variable (Sumantri, 2011). The data is presented in the form of percentage. The evaluation of EPhE effects on the level of students' knowledge in primary health care were categorized in three categories, namely:

- Good, when the subject was able to answer correctly 76% -100% of the whole question.
- Sufficient, when the subject was able to answer correctly 56% -75% of the whole question.
- Less, when the subject was able to answer correctly  $\leq 55\%$  of the whole question.

The data which had been through univariate analysis required to be evaluated further using bivariate analysis. This analysis was used to determine the correlation between the condition before the implementation of EPhE and after EPhE implementation on student's knowledge level in primary health care. A Wilcoxon test was conducted during the data testing process to compare between the two groups of interrelated data. The statistical tests results interpretation was as follows, if the P value  $> \alpha$  (0.05), then there is no significant difference in scores on the level of students' knowledge before and after the implementation of EPE. Whereas when P value  $\leq \alpha$  (0.05), then there is a significant difference in scores towards the level of students' knowledge before and after taking EPhE class.

## **Research Results and Discussion**

### **A. Validity dan Reliability Tests**

Validity test is a test that has a sense on the extent of provision and accuracy of an instrument (questionnaire) in doing its measuring function (Azwar, 2009). An item analysis is used to test each item's validity, which is done by correlating the scores of each item with the total score as the sum of each score point. The correlation used in this research was Pearson correlation. In giving the interpretation of the correlation coefficient, an item that had a value of  $r_{\text{count}} > r_{\text{table}}$  was declared as valid and if the value of  $r_{\text{arithmetic}} < r_{\text{table}}$ , it was declared as invalid. The minimum requirement to be considered as valid was when it showed the correlation coefficient of 0.361 with a standard error of 5%. Thus, if the correlation coefficient  $< 0.361$ , it was declared as invalid.

There were 31 questions on the questionnaire on the level of students' knowledge tested on a number of 30 respondents in accordance with the inclusion criteria. The selection of respondents was done by observing the groupings of students in each primary health care and session and then each representative was selected based on the 1<sup>st</sup> serial no on the presence list. From the validity results obtained, 4 problems were considered as invalid for the questionnaire on the students' level of knowledge, so the questions on the students' level of knowledge were reduced in to 27 questions.

Reliability test is an index indicating the extent to which a measuring instrument is reliable or unreliable. It shows the extent to which the measurement results remain consistent when measurements were taken twice or more on the same symptoms

(Notoatmodjo, 2012). A group of question items are declared as reliable if the numbers of Cronbach alpha coefficient ( $\alpha$ )  $\geq 0.6$  (Arikunto, 2010).

Reliability test was conducted to 30 respondents with the number of questions in total of 31 questions on student knowledge's level questionnaire. The results of Cronbach alpha analysis amounted to the value of 0.909 for the questionnaire regarding the level of students' knowledge, thus it was stated as highly reliable.

Based on the validity and reliability tests of the questionnaire, it could be concluded that of the 31 questions, 27 questions were declared as valid and reliable for the questionnaire on the student's knowledge level (Table 1).

Table 1. Questionnaire on the Students' Level of Knowledge

No.	Question	Yes	No
<b>Administrative requirements regarding pharmacy services at primary health care</b>			
1	Primary health care obtain drugs from PBF.		
2	Pharmacists make the planning demand for drugs in primary health care.		
3	LPPD (Sheets on the Usage and Demand of Drugs) is a sheet that is used to request for medicines to District Health Organization's Pharmacy's storehouse.		
4	Plan the demand for drugs in primary health care based on the type of disease observed in the previous year.		
5	Primary health care request a special medicine outside the regular schedule when a vacancy of drug occurs because of outbreaks.		
6	The report on the use of drugs in primary health care is conducted by Pharmacists.		
7	Primary health care submit a request to the Pharmacy's warehouse every 2 months.		
8	Stocks for hospitalization is held at the end of the month to determine the suitability of the stock on the stock card with the real condition.		
9	A regular report was conducted every 1 month for narcotic drugs and psychotropic.		
10	At the end of the year, primary health care makes a planning on drug demand.		
<b>Drug management is based on regulation</b>			
11	Rack / cabinet arrangement for drugs is based on FIFO (First In First Out).		
12	Primary health care implements alphabetical system in the arrangement of drug storage.		
13	Antibiotic drugs are stored in a tightly sealed chamber, dry and protected from light.		
14	Narcotic and psychotropic drugs are stored in closed and locked cabinets made of wood.		
15	Storage cabinets for narcotic and psychotropic use 2 double lock.		
<b>Prescription services</b>			
16	Prescription Service flow is as follows: prescription received by pharmacists → the pharmacists checked the validity or its completeness → drugs are taken and matched with prescription → drugs are labeled → drugs submitted by pharmacists to the patients.		
17	The prescriptions in primary health care include the name of the doctor and doctor's practice licence.		
18	Pharmacists provide Information, Education, and Conselling in primary health care.		
<b>Archiving the prescriptions</b>			
19	Prescription's storage uses special storage cabinets.		
20	Prescription archiving is performed every 1 month.		
21	All prescriptions are stored for 3 years before they are destroyed.		
<b>Good dispensing practices</b>			
22	Assistant pharmacists perform retrieval, medication compounding and labelling in primary health care.		
23	If drugs are found to be not in accordance with the prescription, pharmacists discuss it with the doctor.		

24	The tools used for compounding the drugs are <i>pulveres</i> types mortar and stamper.
25	Mortars and stamper are cleaned by means of moistened with alcohol after use.
26	Oral type of drug is using white label.
27	Drugs provided from outside of the primary health care is using blue label.

#### B. The Research on the Influence of EPhE towards Students' Knowledge Level

The respondents in this study are students of School of Pharmacy UMY class of 2015 who had followed EPhE in primary health care. This research used a questionnaire with 27 items of questions to determine the level of student knowledge. The questionnaire was given to 30 respondents, by looking at the grouping of students in each primary health care and each session and then one representative was taken, based on the serial number shown in the presence list 2.

Knowledge is the result of "Knowing" and it occurs after people perform sensing on a specific object. Sensing occurs through human senses, namely: the sense of sight, hearing, smell, taste and touch. Most human knowledge is gained through education, other people's experience, the mass media and the environment (Notoatmodjo, 2003). The level of students' knowledge before and after implementing EPhE in primary health care can be seen in Table 2.

Table 2. The Level of Students' Knowledge

Knowledge	Pre Test		Post Test	
	N	%	N	%
Good	15	50	27	90
Sufficient	14	46.67	3	10
Less	1	3.34	0	0
Total	30	100	30	100
p value	0,000			

Table 2 shows that before implementing EPhE in primary health care, as many as 15 respondents (50%) had a good knowledge, as many as 14 respondents (46.67%) have sufficient knowledge, and 1 respondent (3.34%), have lack of knowledge. After doing EPhE in primary health care, respondents still have enough knowledge as much as three respondents (10%) and as many as 27 respondents (90%) have a good knowledge. After calculation using the Wilcoxon test, the result showed p value = 0.000 (<0.005), which means that there are significant differences in scores on the level of students' knowledge before and after the implementation EPhE in primary health care.

Student knowledge of Pharmacy in UMY before and after following EPhE in primary health care was measured by 5 grid of questions, namely: completeness of administration in relation with pharmaceutical services at the health center, medicine management based on regulation, prescription services, archiving recipes, and good dispensing practice. Distribution of student's knowledge level by 5 grid questions can be seen in Figure 1 and Figure 2.

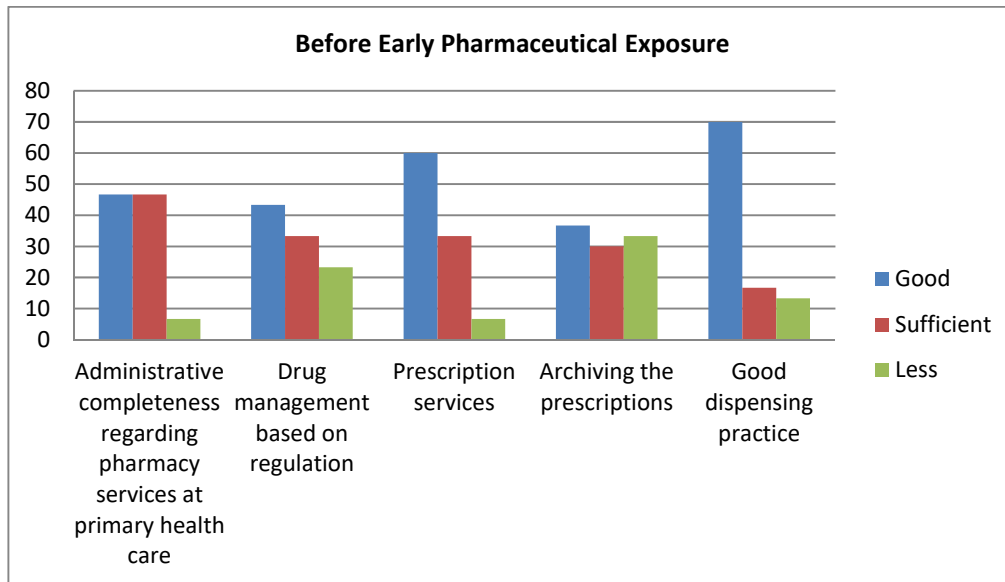

Figure 1. Diagram of Distribution on the Level of Students' Knowledge before EPhE towards 5 Grids of Questions

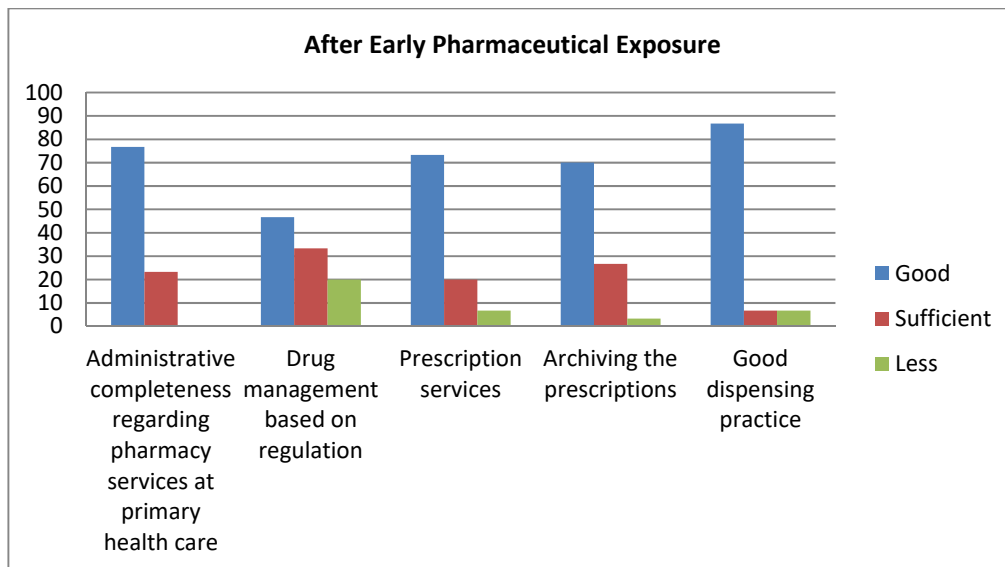

Figure 2. Diagram of Distribution on the Level of Students' Knowledge after EPhE towards 5 Grids of Questions

## Conclusion

Based on the research that had been conducted, it can be concluded that EPhE in primary health care has a positive influence on students' level of knowledge in School of Pharmacy UMY.

## Acknowledgements

This research was supported by University of Muhammadiyah Yogyakarta. We thank to Prof. Dr. Bambang Cipto, MA, Rector of Muhammadiyah University Yogyakarta for the funding support. We also thank to Director of Jogja Hospital for facilitating our research.



## References

- Arikunto, S. (2010). Research Procedure (*Prosedur Penelitian*), Rineka Cipta, Jakarta.
- Azwar, Saifuddin. (2009). Reliability and Validity: Psychological Measurement Series (*Reliabilitas dan Validitas: Seri Pengukuran Psikologi*), Sigma Alpha, Yogyakarta.
- Hidayat. A.A.A. (2007). Nursing Research Methods and Data Analysis Techniques (*Metode Penelitian Keperawatan dan Teknik Analisa Data*), Salemba Medika, Jakarta.
- Indonesian Pharmacist Association. (2011). Decree of the Central Board Indonesian Pharmacist Association No: 058 / SK / PP.IAI / IV / 2011 on Indonesian Pharmacist Competence Standard (*Surat Keputusan Pengurus Pusat Ikatan Apoteker Indonesia No: 058/SK/PP.IAI/IV/2011 Tentang Standar Kompetensi Apoteker Indonesia*), Jakarta.
- Ministry of Health Republic of Indonesia. (2009). Indonesian Government Regulation No. 51 Year 2009 on Pharmaceutical Works (*Peraturan Pemerintah Republik Indonesia Nomor 51 Tahun 2009 Tentang Pekerjaan Kefarmasian*), Jakarta.
- Notoatmodjo, S. (2003). Education and Health Behavior (*Pendidikan dan Perilaku Kesehatan*), Rineka Cipta, Jakarta.
- Notoatmodjo, S. (2012). Health Research Methods (*Metode Penelitian Kesehatan*), PT. Rineka Cipta, Jakarta.
- Nursalam. (2008). Concept and Application of Nursing Research Methodology: Guidelines Final Year Project, Thesis and Research Instruments (*Konsep dan Penerapan Metodologi Penelitian Ilmu Keperawatan: Pedoman Skripsi, Tesis, dan Instrumen Penelitian*), Salemba Medika, Jakarta.
- School of Pharmacy UMY. (2015). Handbook of Academic Year 2015/2016 (*Buku Panduan Akademik Tahun Ajaran 2015/2016*), School of Pharmacy UMY, Yogyakarta.
- School of Pharmacy UMY. (2016). Workbook of Early Pharmaceutical Exposure Block 5 (Basic of Pharmacy IV) (*Buku Kerja Early Pharmaceutical Exposure Blok 5 (Farmasi Dasar IV)*), School of Pharmacy UMY, Yogyakarta.
- Sumantri, Arif. (2011). Health Research Methodology (*Metodologi Penelitian Kesehatan*), Kencana, Jakarta.

---

**THE EFFECT OF SUPPLEMENTATION PROBIOTIC *Lactobacillus casei* SHIROTA STRAIN AGAINST COLONIZATION OF Streptococcus NASAL SWAB ISOLATES FROM PATIENTS WITH ALLERGIC RHINITIS**

**Lilis Suryani<sup>a\*</sup>, Hengki Exsar Aritama<sup>b</sup>**

<sup>a</sup>Department of Microbiology, School of Medicine, Universitas Muhammadiyah Yogyakarta, 55183 Yogyakarta, Indonesia

<sup>b</sup>School of Medicine, Universitas Muhammadiyah Yogyakarta, 55183, Yogyakarta, Indonesia

[\\*lilis\\_fkumy@yahoo.co.id](mailto:lilis_fkumy@yahoo.co.id)

**Abstract**

Allergic rhinitis was an inflammation of the mucosa nasal cavity caused by a type 1 hypersensitivity reaction. Streptococcus was normal flora in nasopharyngeal which is easily spread by droplets from person to person. Streptococcus was Gram-positive bacteria, its caused endocarditis nasopharyngeal infections, skin infections, urinary tractus infections, and oral cavity infections. Probiotics has a positive effect on prevention or treatment of certain disease conditions. Manipulation of intestinal flora with probiotics for the prevention and treatment of rhinitis allergy should be developed. This study aims to determine the effect of supplementation probiotic *Lactobacillus casei* Shirota strain against colonization Streptococcus nasal swab isolates from patients with allergic rhinitis.

This research was quasi-experimental case-control design with a control group pretest-posttest design. The study was conducted at the Microbiology and Research Laboratory School of Medicine Universitas Muhammadiyah Yogyakarta. Forty two students of medicine school Universitas Muhammadiyah Yogyakarta, with the inclusion criteria suspect allergic rhinitis based on history. Volunteers who have a history of allergic rhinitis were taken nasal swab to check the number of Streptococcus bacteria. Volunteers consume milk contained *Lactobacillus casei* Shirota strain daily for 28 days, then taken to be examined Streptococcus nasal swab isolates bacteria numbers.

The results showed that the average number of Streptococcus nasal swab isolates bacteria before supplementation is about 215 CFU and after supplementation is about 127 CFU. It can be concluded that supplementation of probiotic *Lactobacillus casei* Shirota strain decreased the bacteria number of Streptococcus nasal swab isolates in patients with allergic rhinitis.

**Keywords:** allergic rhinitis, *Lactobacillus casei*, nasal swab, Streptococcus

---

**1. Introduction**

Allergic rhinitis is an inflammatory reaction in the nasal cavity mucosa as a result of type 1 hypersensitivity reactions triggered by many allergens. Allergic rhinitis affects about 10-20% population of the world. There many symptoms of the allergic rhinitis like itching in the nose, sneezing, runny nose, and nasal congestion (Bousquet, 2001). Allergic rhinitis is not a fatal disease but reduces the productivity of labor, the

effectivity time of work, and school achievement (Baraniuk, 2000). These disease is caused by an inflammatory reaction mediated by immunoglobulin E (IgE) in the nasal mucosa. The prevalence of allergic rhinitis in Western countries is more than 20%, Korea is 6-10% (Asher, et al., 2006; Cho, et al., 1999), Thailand is 20% (Celikel, et al, 2009). In Indonesia, prevalence of allergic rhinitis in not different with the other countries. The prevalence allergic rhinitis in Bandung is 5.8% (Sumarwan, 1995), Semarang is 18.6% (Suprihati, 2005). When one of the parents do not have allergic rhinitis patients, the risk factors can be reduced by 50% (Badash, 2009). According to Ng and Tan (1994) in Singapore, risk factors such as cockroaches, smoking, air pollution, and exposure to cooking fumes can trigger allergic rhinitis, whereas pets and passive smokers is not a strong correlation as a trigger of allergic rhinitis.

Streptococcus is one of the normal flora of the skin and nasal mucosa are temporary. One time the existence of these bacteria could lead to problems, especially in people who have a history with allergic rhinitis. Normal flora becomes opportunistic pathogens and transmits to the others (Jawetz, et al, 2004). Streptococcus is a positive gram cocci bacterium, facultative anaerobic, amotil, chain composition. These bacteria often cause disease nasopharyngeal infection, endocarditis, skin infections, urinary tractus infections, and infections of the oral cavity. Streptococcus various pathogens such as: *Streptococcus pneumoniae*, *Streptococcus viridans*, *Streptococcus agalactiae*, *Streptococcus mutans*.

Recently, the prevention of allergic diseases requires an understanding of the maturation process of the immune defense mechanism. Current research indicates that probiotics had a strong influence on the regulation of primary immunophysiological in intestinal mucosal barrier (Rautava, 2005). Probiotics are live microorganisms, when consumed has a positive effect on the prevention or treatment of a particular disease condition. The potential of probiotics change the composition of the intestinal flora of certain high-risk groups, such as premature babies, patients with diarrhea, the children were treated with antibiotics, patients with viral gastroenteritis and some atopic diseases are not only potential applications, but also the mechanism of these agents due to the interaction of probiotics in the gut as an immune organ. The benefits of probiotics dependent on the amount of agent, dose, dosing patterns, and characteristics of the host and the microbe environment of the underlying lumen (Saavedra, 2001).

## 2. Material and Methods

This study is a quasi-experimental case-control design with a control group pretest-posttest design. About 42 volunteers (25 men and 17 women) with allergic rhinitic, students of medicine school Universitas Muhammadiyah Yogyakarta, were included in this study. Volunteers who have a history of allergic rhinitis were taken nasal swab to check the number of *Streptococcus* bacteria before and after supplementation with probiotic. The respondents provided written informed consent. The respondents consumed one bottle of a fermented milk drink 65 mL (PT Yakult Indonesia Persada) daily from day 1 to 28. The probiotic fermented milk drink contained *Lactobacillus casei* Shirota strain. Swabs from nasal cavities of each responden were inoculated onto sheep blood agar, and then incubated at 37°C, 24 hours. A series of method had been done to identification of Streptococcus from the grows colony in the blood agar media, such as Gram staining, hemolysis type and catalase test. Data analysis by the paired t-test.

## 3. Result

The results of this examination can be seen in Figure 1. From 42 nasal swab samples were examined, almost 100% of the total number of Streptococcus decreased. The average total number of Streptococcus nasal swab isolates before supplementation is about 215 CFU. After supplementation of *Lactobacillus casei* Shirota strain daily for 28 days, the average total number become 127 CFU. This study showed that the

*Lactobacillus casei* Shirota strain daily for 28 days reduces the number of Streptococcus nasal swab isolates in patients with allergic rhinitis. The statistical analysis paired t-test results obtained  $p < 0.05$ .

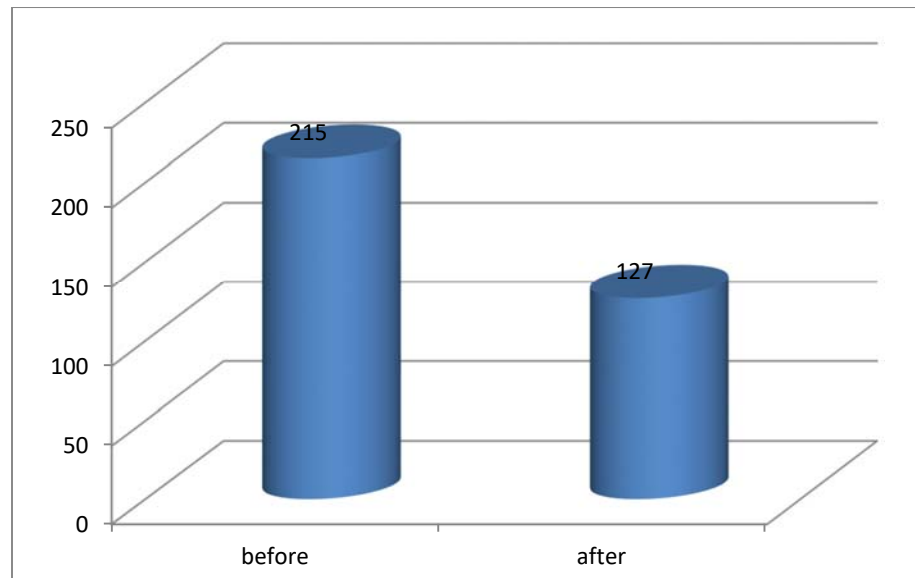

Figure 1. The total number of Streptococcus nasal swab isolates before and after supplementation of *Lactobacillus casei* Shirota strain daily for 28 days in patients with allergic rhinitis

#### 4. Discussion

This research shows that supplementation of *Lactobacillus casei* Shirota strain daily reduces the Streptococcus colonisation in nasal cavity. The nasal cavity is a habitat for many different normal flora. One of these bacteria, such as *Staphylococcus*, *Streptococcus* and *Haemophilus*. These bacteria have potentially pathogenic bacteria. Patients with suspected allergic rhinitis have a higher risk of infection with these bacteria. It is interesting to eliminate the potentially pathogenic normal flora in the nose cavity (Kluytmans, 1998). Probiotic bacteria are known to have beneficial effects in humans, mainly by affecting the flora of the intestinal tract. The supplementation of *Lactobacillus* GG decreased the number of children patient with respiratory tract infections about 17%. *Lactobacillus* GG inhibits the colonization of pathogenic bacteria, lowering of oxidative enzyme activity, reinforcement of the mucosal barrier, and stimulation of immunologic memory (Saxelin, 1997). Current research indicates probiotics had a strong influence on the regulation of primary immunophysiology in intestinal mucosal barrier (Rautava, 2005). Supplementation *Lactobacillus* bacteria may inhibit the production of Th2 cytokines by mononuclear cells in allergic patients. Probiotic treatment also prevent atopic disease. Naturally *Lactobacillus* is found in the human digestive tract and vagina. *Lactobacillus* produces amylase enzyme in gastrointestinal tract. This bacteria also produces niacin, pyridoxine, folic acid in the digestive tract. Niacin is needed in DNA repair cell and steroid hormone production. Vitamin B6 is important in the formation of blood cells and nerve conduction. *L. acidophilus* improves the immune system, inhibit diarrhea and prevent candidiasis vaginal infection or oral cavity infection (Salazar, et al., 2007; Sazawal, et al., 2006)

There are many the benefit of supplementation *Lactobacillus* for human health, among others: caused gastrointestinal environmental acidity, so inhibit the growth of harmful bacteria, activated the immune system especially the gastrointestinal tract when the body's immune response is low and improved the body's tolerance to a

variety of oral allergens. *Lactobacillus* compete with pathogen bacteria to adhere the receptor in the mucosa membrane cell of gastrointestinal tract. *Lactobacillus* produce a variety of digestive enzymes (phosphatase, lysozyme) and vitamins (B1, B2, B6, folic acid, and biotin) that will be absorbed in the small intestine and helps absorption calcium. *Lactobacillus* also produce colicine that antibacteria activity for harmful bacteria (Gibson and Collins, 1999; Vandenplas, 1999; Patricia, 1999).

## 5. Conclusion

This study suggested that supplementation of probiotic *Lactobacillus casei* Shirota strain decreased the bacteria number of *Streptococcus* nasal swab isolates in patients with allergic rhinitis.

## Acknowledgment

Researchers would like to thank to LP3M Universitas Muhammadiyah Yogyakarta and PT. Yakult Indonesia Persada that have funded this research through the entire partnership program.

## References

- Asher, MI., Montefort, S., Björkstén, B., et al. (2006). ISAAC Phase Three Study Group. Worldwide Time Trends in The Prevalence of Symptoms of Asthma, Allergic Rhinoconjunctivitis, and Eczema in Childhood: ISAAC Phases One And Three Repeat Multicountry Cross-Sectional Surveys. *Lancet*, Vol.368, pp:733-743.
- Badash, M. (2009). Risk Factor For Allergic Rhinitis. <http://www.mbhs.org/healhgate/GetHGContent.aspx>. Last Accessed 27 Juni 2011.
- Baraniuk. JN. (2000). Mechanisms of Rhinitis. *Immunology and Allergy Clinics of North America*, Vol.20, pp.245-264.
- Bousquet, J., Cauwenberge,VP and Khaltev, P. (2001). Allergic Rhinitis and its Impact on Asthma. *J. Allergy Clin Immunol*, Vol.108, pp.148-S195.
- Celikel, S., Isik, S., Karakya, G.,Kalyancu, A. (2008). Risk Factor for Asthma and Other Allergic Disease in Seasonal Rhinitis. *J. Asthma*, Vol. 5(8), pp: 710-714.
- Cho, SH., Kim, YK., Sohn, JW., et al. (1999). Prevalence of Chronic Rhinitis in Korean Children and Adolescents. *Korean J. Asthma Allergy Clin. Immunol*, Vol. 19, pp:452-458.
- Gibson, GR, and Collins, MD. (1999). Concept of Balanced Colonic Microbiotica, Prebiotica and Synbiotica. *Nestlee Nutrition Workshop Series*, Vol. 42, pp:139-56
- Jawetz, E, Melnick, JL, Adelberg, EA, Brooks, GF, Butel JS, and Orston, LN. (2005). *Medical Microbiology*. 20<sup>ed</sup>. Prentice-Hall International Inc, pp:211-215.
- Kluytmans, JA. (1998). Reduction of Surgical Site Infections in Major Surgery by Elimination of Nasal Carriage of *Staphylococcus aureus*. *J. Hosp Infect*, Vol.40, pp.25-9.
- Ng,TP and Tan, WC. (1994). Epidemiology of Allergic Rhinitis and its Associated Risk Factors in Singapore. *Int. J. Epidemiology*, Vol.23(3), pp: 553-558.
- Patricia, LC. (1999). Selection Criteria for Probiotic Microorganisms. *Asia Pacific J Clin. Nutr.*, Vol.5, pp:10-4.
- Rautava, S, Kalliomaki, M, Isolauri, E. (2005). New Therapeutic Strategy for Combating the Increase Burden of Allergic Disease: Probiotic-A Nutrition, Allergy, Mucosal Immunology and Intestinal Microbiota Research Group Report. *J Allergy Clin Immunol*, Vol.108, pp: 148-195.
- Saavendra, JM. (2001). Clinical Applications of Probiotic Agents. *Am. J. Clin Nutr*, Vol.73(Suppl), pp:1147-1151.
- Salazar-Lindo, E, Figueroa-Quintanilla, D, et al. (2007). Effectiveness and Safety of *Lactobacillus* LB in the Treatment of Mild Acute Diarrhea in Children. *J. Pediatr Gastroenterol Nutr* Vol.44(5), pp:571-576.

- Saxelin, M. (1997). *Lactobacillus* GG—a Human Probiotic Strain with Thorough Clinical Documentation. *Food Rev Int*, Vol. 13, pp.293–313.
- Sazawal, S, Hiremath, G, Dhingra, U, et al. (2006). Efficacy of Probiotics in Prevention of Acute Diarrhoea: A Meta-Analysis of Masked, Randomised, Placebo-Controlled Trials. *Lancet Infect Dis.*, Vol.6(6), pp:374-82.
- Sumarman, I. (1993). Activated Eosinophil and Other Inflammatory Cells Found in Nossal Concha Mucous Membrane of Perennial Allergic Rhinitis. Symposium on Consensus and Controversy of Allergic Rhinitis Management. Asean ORL Congress Chiang Ray Thailand.
- Suprihati. (2001). Patofisiologi Dan Prosedur Diagnosis Rinitis Alergi. In Symposium Current and Future Approach in The Treatment of Allergic Rhinitis. Semarang, pp:1-11.
- Vandenplas, Y. (1999). Bacteria and Yeasts in The Treatment of Acute and Chronic Infectious Diarrhea. *Clin. Microbiol Infect*, Vol.5, pp:299-307.

---

**STEROIDAL SAPONIN IN ETHANOL EXTRACT TUBER OF PURPLE  
YAM (*Dioscorea alata L.*) AS ALLERGENIC AGENT ON  
SENSITIVITY PHASE BALB/c MICE MODEL ALLERGY**

**Sri Nabawiyati Nurul Makiyah<sup>a\*</sup>, Sri Tasminatun<sup>b</sup>, Muhaimin Rifa'i<sup>c</sup>,  
Widodo<sup>c</sup>, Muhammad Sasmito Djati<sup>c</sup>**

<sup>a</sup>*Department of Histology & Biology, Medical Science Study Programe Faculty of Medicine  
& Health Science, Universitas Muhammadiyah Yogyakarta; Jalan Lingkar Selatan  
Tamantirto Kasihan Bantul DIY, Indonesia 55183*

<sup>b</sup>*Pharmacy Study Programme, Faculty of Medicine & Health Science, Universitas  
Muhammadiyah Yogyakarta; Jalan Lingkar Selatan Tamantirto Kasihan Bantul DIY,  
Indonesia 55183*

<sup>c</sup>*Biology Department, Faculty of Mathematic and Sciences, Brawijaya University Jalan  
Veteran Malang East Java Indonesia*

---

**Abstract**

Purple yam (*Dioscorea alata L.*) is a source of biological tubers not been used optimally. Diosgenin is steroids saponin compounds that most important because it has multiple biological functions, such as allergenic activity. The objective of this research was to analyze the potential allergenic ethanol extract tuber of *D. alata L.* (EEDA) on BALB/c mice on sensitivity phase with measure the profile of transcription factor FoxP3 Treg cells and cytokine profile of Treg and IgE and IgG1 B cells. An experimental study using BALB/c mice divided into 7 groups: control group (I), the treatment group (II-V) ethanol extract of tuber *Dioscorea alata L.* dose of 0.00; 0.17; 2.01; 10.04 g/kg bw, the treatment group antihistamines drug and Diosgenin (VI-VII). For 17 consecutive days the group II-VII were treated in accordance with the group and with Ovalbumin induced allergy models. Mice were sacrificed on day 18. Spleen is removed, lymphocyte isolated and analyze the transcription factor FoxP3 Treg cells, cytokine profile of T reg cells and IgE and IgG1 B cells on spleen using Flowcytometry FACS Calibur. The results showed EEDA able to inhibit the production of B220IgE and B220IgG1, trigger Treg cells (CD4CD25) and the transcription factor FoxP3 (CD4CD25FoxP3) and profile of the cytokines produced by T reg cells. The conclusion is ethanol extract tubers of *Dioscorea alata L.* (EEDA) does not trigger Treg (CD4CD25) and the transcription factor FoxP3 (CD4CD25FoxP3) and cytokine profiles produced by Treg cells namely CD4IL-10, CD8IL-10, CD4TGF- $\beta$  and CD8TGF- $\beta$  in the sensitivity phase.

**Keywords:** Saponin steroid of ethanol extract of the tubers of *Dioscorea alata L.*; allergenic agent; Treg cells; the transcription factor FoxP3; lymphocyte.

---

**1. Introduction**

Purple yam (*Dioscorea alata L.*) is a source of biological tubers that has not been used optimally. *D. alata L.* contains Diosgenin (Cheng *et al.*, 2007) i.e. main steroidal saponin steroid aglicon as intermediate steroidal in pharmaceutical manufacture. Steroidal saponin is the most importance bioactive compound because it have biological function. The result of some research showed that steroidal saponin have allergenic activity (Zhang *et al.*, 2012).

The latest studies of T regulatory (Treg) cells reveals the importance of effector function of this cell population in controlling allergic responses. It has been proven that an allergic person reduce the number and function of Treg (Shreffler et al., 2009; Palomares et al., 2010). Treg cells is able to inhibit the development of allergic Th2 response (Akdis et al., 2004) and plays an important role in allergen specific immunotherapy (Akdis et al., 1998; Jutel et al., 2003). FoxP3 transcription factor plays an important role in the maintaining self-tolerance and immune homeostasis (Sakaguchi et al., 2008). FoxP3 transcription factor important in the development of Treg cells and a marker of confirming the presence of Treg cells (Zheng & Rudensky, 2007; Sakaguchi, 2004).

Treg cells produce IL-10 and TGF- $\beta$  cytokines which they inhibit the activation of lymphocytes and macrophages. Treg cells also directly interact and suppress other lymphocytes or antigen presenting cells (Abbas & Lichtman, 2011). Treg cells through its cytokines, IL-10 and TGF- $\beta$ , capable monitoring the immune response, inhibits hyperpolarization Th1 (autoimmune disease) or Th2 (allergic diseases) and further regulate the balance of Th1/Th2 (Gourbeyre et al., 2011) as well as suppressing IgE released by B cells (Huang et al., 2009). TGF- $\beta$  is an important factor in the regulation of T cell mediated immune response and plays a role in the induction of immune tolerance (Gorelik and Flavell, 2002; Chen & Wahl, 2002).

Allergic reactions involving IgE specific antibodies (Ewan, 1998). IgE is a key molecules that act as mediators of allergic responses (asthma, rhinitis, food allergies, atopic dermatitis, etc.) (Gould & Sutton, 2008). According to Saldanha et al. (2004), Ovalbumin as allergen sensitization in mice increases levels of IgE and IgG1 in blood sera.

The objective of this research was to analyze the potential allergenic ethanol extract tuber of *Dioscorea alata* L. (EEDA) on BALB/c mice on sensitivity phase with measure the profile of the transcription factor FoxP3 Treg cells and cytokine profile of Treg and IgE and IgG1 B cells.

## 2. Materials and Methods

Experimental animals are mice (*Mus musculus*) BALB/c strain, 7-8 weeks with a healthy condition. This research has got the certificate of eligibility of ethics (Ethical Clearance) of the Research Ethics Committee (Animal Care and Use Committee) UB No. KEP-144-UB.

Experimental research on BALB/c mice with *posttest only control group design*. Independent variable is ethanol extract of tubers *Dioscorea alata* L. dose 0.00 g/kg, 0.17 g/kg, 2.01 g/kg and 10.04 g/kg. Dependent variable is profile of transcription factor FoxP3, cytokine profile of T reg cells (IL-10, TGF- $\beta$ ) and IgE and IgG1 B cells on spleen.

Dose ethanol extract of the tubers of *Dioscorea alata* L. converted from dose human weighing 70 kg to 20 grams mice, multiplied by the conversion value 0.0026, so we get first dose of 0.17 g/kg, 2 doses of 2.01 g/kg and 3 doses of 10.04 g / kg.

**Mice Model Allergic Digestive Tract on Sensitivity Phase.** BALB/c mice intraperitoneally sensitized with Ovalbumin. Mice immunized with intraperitoneal injections on day 15 with 0.15 ml Ovalbumin in Al(OH)<sub>3</sub> which is made of 2.5 mg Ovalbumin dissolved in 7.75 ml of Aluminium Hydroxide (Fischer et al., 2005; Diding et al., 2008).

Twenty one male Balb C mice divided into seven groups: control (C), treatments with ethanol extract tubers of *Dioscorea alata* 0,00 g/kg, 0.17 g/kg, 2.01 g/kg, 10.04 g/kg (T I – T IV), treatment with antihistamine drug 0,4 mg/mice/day (T V) and treatment with Diosgenin 200 mg/kg (T VI) (Huang et al., 2010). For 17 consecutive days the T I- T IV groups were given ethanol extract of *D. alata* respectively with its dose, T IV group given antihistamine drugs and T V group given Diosgenin. On day 15, NC dan



T I – T V groups of mice were induced Ovalbumin 0,0483 mg/mice (Fischer *et al.*, 2005 with modification by Diding *et al.*, 2008). On day 18, three mice each group were sacrificed with cervical dislocation, mice were dissected and spleen is taken to isolated its lymphocytes and analyze the transcription factor FoxP3 Treg cells, cytokine profile of T reg cells and IgE and IgG1 B cells on spleen using Flowcytometry FACS Calibur.

**Statistical analysis of the data.** Data are presented as means  $\pm$  SD. Comparison between groups was performed by the one-way analysis of variance continued with Tukey test. Considered a value of  $p < 0.05$  was statistically significant.

### 3. Results and Discussion

Body weight of mice on sensitization phase weighed every day for 17 consecutive days. Figure 1 showed the weight of mice on sensitization phase after injected Ovalbumin intraperitoneally on day 15 experienced a weight loss of 5.44% on the 16th day and 4.15% on day 17. There is significant effect of Ovalbumin injection on weight loss ( $p < 0.05$ ).

Weight parameter in this study need to be displayed because one of the marker of success murine model of allergic is the occurrence of diarrhea in mice is characterized by watery stools and weight loss. This study succeeded in making mice model of allergic through a slight drop weight after giving Ovalbumin allergen which is appropriate with Mollica *et al.* (2013) research. The diarrhea in mice is characterized by watery stool that also occurs in mice model of allergic gastrointestinal tract is shown with stools more watery and runny.

This research indicate that there is no difference in feed intake between groups of mice, but mice treated Ovalbumin lose a little of their body weight. It is caused by the occurrence of hypercatabolism which are caused by the production of inflammatory cytokines (Dourado *et al.*, 2010). This study did not evaluate further whether weight loss in the treatment group Ova is caused by a decrease in feed consumption or water retention as Moreira (2006) research in mice were sensitized with Ovalbumin. Jan *et al.* (2007) research also showed that the body weight of mice which is treated Diosgenin dose 200 and 400 mg/kg, there was no significant difference in body weight of mice untreated control group.

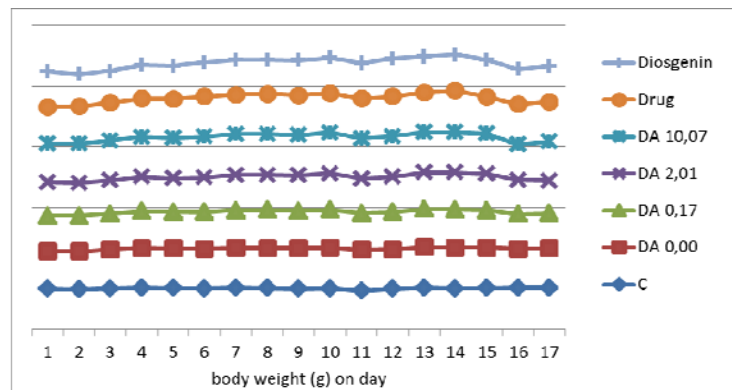

**Figure 1.** Comparison of body weight of mice (g) on the sensitivity phase in the control group (C) and treatment group with EEDA 0.00; 0.17; 2.01 and EEDA 10.04 g/kg, Antihistamines Drugs and Diosgenin.

According to Saldanha *et al.* (2004), Ovalbumin as allergen sensitization in mice increases levels of IgE and IgG1 in blood sera. IgE and IgG1 (Th2 response) versus IgG2a (Th1 response) is a good marker for the induction of allergic responses in mice (Adel-Patient *et al.*, 2000). According Dourado *et al.* (2011), sensitization Ovalbumin in BALB/c mice increases levels of IgE and IgG1.

This study showed that it has been an increase in B220IgE and B220IgG1 cytokine profiles in treatment group induced Ovalbumin on EEDA 0.00; 0.17; 2.01; 10.04 g/kg; Anti Histamin Drugs and Diosgenin groups compared with the control group in the sensitization phase. The highest B220IgE and B220IgG1 cytokine profile EEDA 10.04 g/kg group and the lowest B220IgE and B220IgG1 cytokine profile is in the control group as shown in Figure 2(a).

The results are consistent with Barwig et al. (2010), Aguilar-Pimentel et al. (2010) and Lee et al. (2013) that intraperitoneal injection of Ovalbumin with low doses as an antigen together with Aluminum Hydroxide as adjuvant result in increased formation of IgE antibodies with high levels. The results of this study demonstrate that Ovalbumin as allergens managed to create mice model of allergic proven by administering Ovalbumin can increase levels of IgE and IgG1 on BALB/c mice on sensitivity phase because one of the clinical symptoms of allergy are increased levels of IgE and IgG1 (Dourado et al., 2010, Makiyah et al., 2014).

Ovalbumin in this study can stimulate allergic reactions. IgE is a cytokine that was very crucial in the development of allergic reactions (Li-Weber and Krammer, 2003; Cookson, 2004; Diding et al., 2008). Haghighi et al. (2006) showed that administration of oral Ovalbumin in mice were able to induce the production of Th2 cytokines and IgE, which it will result in an immune response to the allergic-inflammatory.

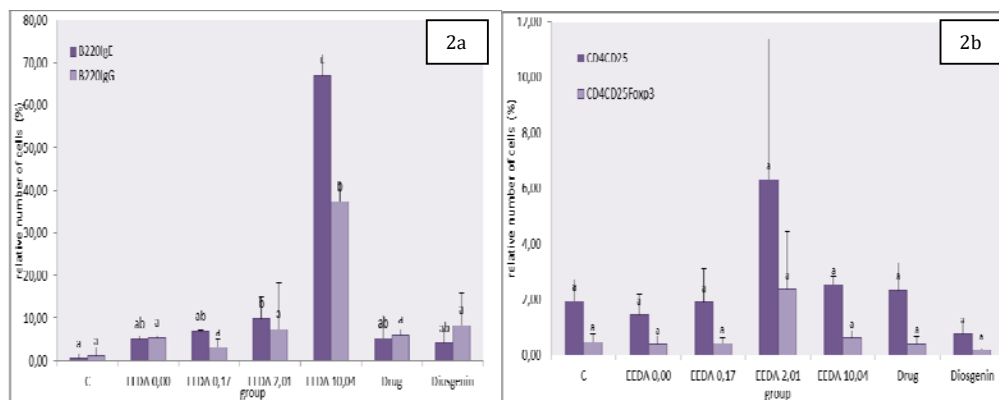

**Figure 2** Comparison of relative number of cells of mice expressing B220IgE and B220IgG1 and **(b)** CD4CD25 and CD4CD25FoxP3 on the sensitivity phase. Description: a bar chart followed by the same letters between group means there is no significant difference ( $p > 0.05$ ).

There are significant difference on B220IgE and B220IgG1 ( $p < 0.05$ ) cytokine profile in sensitivity phase and Tukey's test showed there are significant difference B220IgE cytokine profile between EEDA dose 10.04 g/kg with the Control group. EEDA dose of 0.00; 0.17; 2.01 g/kg, Anti Histamine Drugs and Diosgenin while among the Control group, EEDA dose of 0.00; 0.17 g/kg, Anti Histamine Drug and Diosgenin showed there are no significant difference. Between EEDA dose of 0.00; 0.17; 2.01 g/kg, Anti Histamine Drug and Diosgenin groups showed no significant difference. Tukey test results showed significantly different between groups B220IgG1 cytokine profile of EEDA dose of 10.04 g/kg with the Control group. EEDA dose of 0.00; 0.17; 2.01 g/kg, Anti Histamine Drug and Diosgenin while among the Control group, EEDA dose of 0.00; 0.17; 2.01 g/kg, Anti Histamine Drug and Diosgenin showed there are no significant difference.

CD4<sup>+</sup>CD25<sup>+</sup> cells is thought as conventional cells that express the CD25 surface molecules and regulatory T cells that will surely increase with the entry of foreign substances are inserted into the body. CD25 surface molecules known also as the IL-2 $\alpha$  receptor, which may be expressed by conventional cells other than CD4<sup>+</sup> T cells (Lee et

al., 2006). CD4CD25 Treg cells were identified by expression of double-positive CD4 and CD25 markers specific membrane.

This study showed that on the sensitivity phase already increased CD4CD25 cytokine profile in the EEDA dose of 2,01; 10.07 g/kg and Anti Histamine Drug group, as also been has an increase in transcription factor CD4CD25FoxP3 profile in the EEDA doses of 2.01 and 10.04 g/kg group as shown in Figure 3. CD4CD25 cytokine profile and transcription factors CD4CD25FoxP3 on the sensitivity phase showed no significantly difference ( $p > 0.05$ ).

Treg cells play an important role in immunological disorder underlying allergic disease (Wu et al., 2007). Treatment of asthma allergic diseases latest also focused on increasing the role of T reg cells to protect against severity of asthma (Nouri-Aria & Durham, 2008). Some studies showed the occurrence of a significant reduction of Treg cells CD4<sup>+</sup>CD25<sup>+</sup>Foxp3 in perifer blood and bronchoalveolar lavage fluid of patients with asthma (Ryanna et al., 2009). Some therapies in allergic disease is known to increase Treg cells (Nouri-Aria & Durham, 2008). Treg cells has been widely utilized as an experimental model for treating various diseases including allergic diseases (Kearley et al., 2008). Some research has also shown the role of FoxP3 and CD4CD25 Treg cells in allergic disease (Stock et al., 2006).

Susanti et al. 2013 research on children with asthma given a combination of adjuvant and *Nigella sativa* increase the percentage of CD4<sup>+</sup>CD25<sup>+</sup>Foxp3<sup>+</sup> Treg. Lopes et al. (2006) research proved that intracellular Foxp3 protein delivery inhibits the activation of T cells after stimulation of the T cell receptor (TCR) and the resulting suppressor function of T cells CD4<sup>+</sup>CD25<sup>-</sup>. Many recent studies have examined the role of Foxp3 Treg cells and CD4<sup>+</sup>CD25<sup>+</sup> in allergic asthma and atopic patients (Stock et al., 2006). Peripheral blood mononuclear cells from patients with allergic rhinitis and asthma had fewer lymphocytes expression of Foxp3<sup>+</sup> and Foxp3 mRNA was significantly decreased (Hartl et al. 2007, Lee et al., 2007). Treg cells from atopic patients have less suppressor activity compared with Treg cells from non-atopic group (Ling et al., 2004), suggesting that Treg Foxp3 and has an important role in regulating the immune response in humans hypersensitive. Therefore, Foxp3 is a very important target for the development of immunosuppressive agents for both autoimmune diseases and allergies. Despite the importance of Foxp3 in imunotoleransi has been studied extensively, the clinical use of gene transfer of Treg or Foxp3 for this disease is still limited because of the difficulty of isolating the T reg cells human, transfection efficiencies are low, and the high risk gene viral-mediated delivery (Choi et al., 2010 ).

Treg cells eject function of its imunoregulatory through various mechanisms, among others, require CTLA-4, turn off the antigen presenting cell or T lymphocytes directly, using IL-2 cytokine, production immunosuppression cytokine such as IL-10, TGF-beta, IL-35 and galectin-1 (Vignali et al., 2008).

Treg cells secrete IL-10 and TGF- $\beta$  in bulk (Shevach, 2009). IL-10 is a antiinflammatory cytokine produced Treg cells that control the peripheral immune response (Hawrylowicz, 2005) and plays a role in protection against allergic disease on individuals with mutations in FoxP3 (transcription factor Treg cells) in patients with food allergy (Hawrylowicz, 2005). Immu-notherapy to treat allergies have also been shown to increase levels of IL-10, which works by inhibiting the activity of Th2 cells (Akdis et al., 1998). Kearley et al. (2005) found a decrease in the production of Th2 cytokines in mice sensitized with Ovalbumin when granting Treg cells purified before exposure to antigen; they found that the production of IL-10 is not limited to Treg cells.

The result indicates that the sensitivity phase increased cytokine profile CD4IL-10 in the treatment group, namely Ovalbumin induced dose group EEDA 0.00; 0,17; 2,01; 10.07 g/kg, treatment with Anti Histamine Drugs and Diosgenin treatment, as well as an increase in CD8IL-10 cytokine profiles in the treatment group, namely Ovalbumin induced dose group EEDA 0.00; 0,17; 2,01; 10.07 g/kg and treatment with Anti Histamine Drug as shown in Figure 2(b).

CD4IL-10 and CD8IL-10 cytokine profile with one way Anova test showed no significant difference on CD4IL-10 cytokine profile ( $p>0.05$ ) and significantly difference on CD8IL-10 cytokine profile ( $p<0,05$ ). Tukey test results showed no significant difference CD8IL-10 cytokine profiles between treatment groups EEDA dose of 2.01 g/kg with Control, EEDA dose of 0.00; 0.17; 10.04 g/kg, Anti Histamine Drug and Diosgenin treatment. There was no significant difference between Control groups, EEDA dose 0.0 g/kg, Anti Histamine Drug and Diosgenin treatment. There was no significant difference between the Control groups with the EEDA dose of 0.00; 10.07 g/kg and Anti Histamine Drug treatment, there was no significant difference between EEDA 0.17 g/kg and 10.04 g/kg groups.

This study indicate that on the sensitivity phase increased CD4IL-10 cytokine profile in the treatment group induced with Ovalbumin namely EEDA dose 0.00; 0,17; 2,01; 10,07 g/kg, Anti Histamine Drug treatment and Diosgenin treatment, as well as an increase in CD8IL-10 cytokine profiles in the treatment group induced Ovalbumin namely EEDA dose 0.00; 0,17; 2,01; 10,07 g/kg and Anti Histamine Drug treatment as shown in Figure 3(a).

CD4IL-10 and CD8IL-10 cytokine profile in sensitivity phase showed no significant difference in CD4IL-10 cytokine profiles ( $p: 0.061$ ) and significantly difference in cytokine profiles CD8IL-10 ( $p: 0.00$ ). Tukey test showed significantly difference on CD8IL-10 cytokine profiles between EEDA dose of 2.01 g/kg treatment groups with Control, EEDA dose 0.00; 0.17; 10.04 g/kg, Anti Histamine Drug treatment and Diosgenin treatment. There is no significant difference between Control, EEDA dose 0,00 g/kg, Anti Histamine Drug treatment and Diosgenin treatment and there is no significant difference between the Control, EEDA dose 0,00; 10, 07 g/kg and Anti Histamine Drug treatment, no significant difference between groups EEDA dose 0.17 g/kg and EEDA dose 10.04 g/kg.

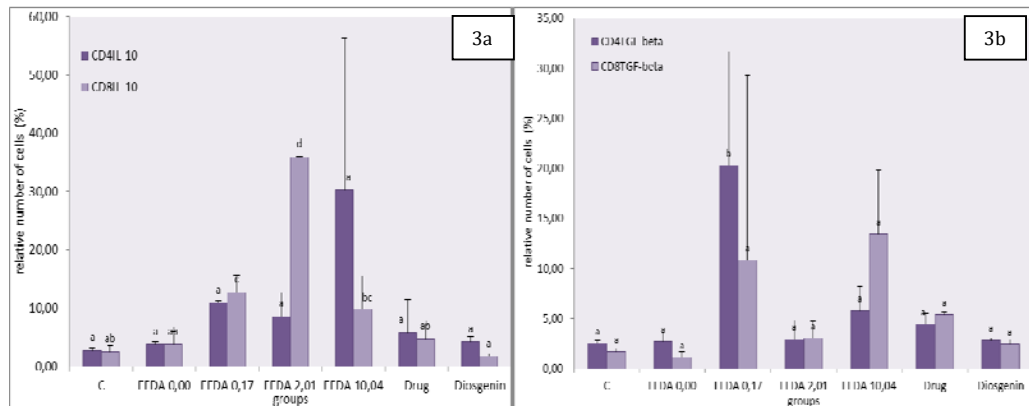

**Figure 3. (a)** Comparison of the relative number of cells of mice expressing CD4IL-10 and CD8IL-10 and **(b)** CD4TGFβ and CD8TGFβ on the sensitivity phase after given the ethanol extract tubers of *Dioscorea alata* L. (EEDA). Description: a bar chart followed by the same letters between group means there is no significant difference ( $p> 0.05$ ).

The results of this study showed that the CD8TGFβ and CD4TGFβ cytokine profile in sensitivity phase increased in the treatment group namely EEDA dose of 0,17; 2,01; 10,07 g/kg, Anti Histamine Drug treatment and Diosgenin treatment.

There is significantly differences in CD4TGFβ cytokine profiles ( $p<0.05$ ) and no significant differences in CD8TGFβ cytokine profiles ( $p>0.05$ ) in the sensitivity phase. Tukey test showed there is significantly difference in CD4TGFβ cytokine profiles between treatment groups EEDA dose of 0.17 g/kg with Control group, EEDA dose 0,00; 2.01; 10.04 g/kg, Anti Histamine Drug treatment and Diosgenin treatment. There is no significant difference between Control groups, EEDA dose 0,00; 2.01; 10.04 g/kg, Anti Histamine Drug and Diosgenin treatment as shown in Figure 3(b).

Susceptibility to allergic diseases can not only be explained with a single through the impaired balance between Th1 and Th2 responses. Currently the immunoregulatory role of Treg cells has been known to suppress the adaptive immune response mediated by Th1 and Th2 (Herrick & Bottomly, 2003; van Oosterhout & Bloksma, 2005).

To develop immunosuppressive agents for treating autoimmune diseases or allergies, the regulation of T cell activation and function of Treg cells is an important target. Foxp3 has an important role not only as a key molecule in the development of regulatory T cells, but also as an inhibitor of T cell activation and repressor of transcription factors (Wan and Flavell, 2007; Campbell & Ziegler, 2007; Lopes et al., 2006).

This study showed that on the sensitivity phase, giving EEDA dose 2.01; 10.04 g/kg and Anti Histamin Drug increase CD4CD25 cytokine profile and giving EEDA 2.01; 10.04 g/kg increase transcription factors CD4CD25FoxP3, giving EEDA 0.17; 2.01; 10.04 g / kg; Anti Histamin Drug and Diosgenin increase cytokine profile CD4IL-10, giving EEDA 0.17; 2.01; 10.04 g/kg and Anti Histamin Drug increase cytokine profile CD8IL-10, giving EEDA 0.17; 2.01; 10.04 g/kg, Anti Histamin Drug and Diosgenin increase CD4TGF- $\beta$  and CD8TGF- $\beta$  cytokine profile.

The ethanol extract of *Dioscorea alata* L. with the active compounds contained it, one of which is a saponin steroids are useful as allergenic agent able to activate regulatory T cells so that the sensitization phase EEDA 2.01 and 10.04 g/kg increase CD4CD25 cytokine profile and transcription factors CD4CD25FoxP3. BALB/c mice which only induced Ovalbumin namely the EEDA 0,00 g/kg decreased the percentage of transcription factors CD4CD25FoxP3 on the sensitization phase. BALB/c mice which induced Ovalbumin and treated EEDA 0.17; 2.01; 10.04 g/kg, Anti Histamin Drug and Diosgenin are increase in the percentage of transcription factors CD4CD25FoxP3 on the sensitization phase.

Giving EEDA has no significantly effect on CD4CD25 cytokine profiles and the percentage of CD4CD25FoxP3 transcription factors in the sensitization phase. This shows that the possibility of increasing the activity of T reg cells and transcription factors CD4CD25FoxP3 triggered by other factors including through the profiles of cytokine produced by T reg cells: CD4IL-10, CD8IL-10, CD4TGF- $\beta$ , CD8TGF- $\beta$ . The results of this study according to Huang et al. (2009, 2010) which showed an increase in the number of cells of IL-10<sup>+</sup>FoxP3<sup>+</sup> allergic of mice treated Diosgenin.

#### **4. Conclusion**

Ethanol extract tubers of *Dioscorea alata* L (EEDA) does not trigger Treg (CD4CD25) and the transcription factor FoxP3 (CD4CD25FoxP3) and cytokine profiles produced by Treg cells namely CD4IL-10, CD8IL-10, CD4TGF- $\beta$  and CD8TGF- $\beta$  in the sensitivity phase.

#### **Acknowledgements**

A sincere appreciation to the Research Grant of Directorate General of Higher Education Ministry of Research, Technology and Higher Education Republic of Indonesia which have funded this research. Researchers also would like to express gratitude to Mr. Bambang and Mrs. Dewi Satwika as the technician in this study.

## Reference

- Abbas AK and Lichtman AH. (2011). *Basic Immunology: Functions dan Disorders of The Immune System*. 3<sup>th</sup> ed. Saunders Elsevier. Philadelphia. pp. 8-13, 266, 107-109, 246.
- Adel-Patient K, Créminon C, Bernard H, Clément G, Négroni L, Frobert Y., *et al.* (2000). Evaluation of a high IgE-responder mouse model of allergy to bovine  $\beta$ -lactoglobulin (BLG): development of sandwich immunoassays for total dan allergen-specific IgE, IgG1 dan IgG2a in BLG-sensitized mice. *J. of Immunological Methods*, Vol. 235, No. 1-2, pp. 21-32.
- Aguilar-Pimentel JA, Alessdanrini F, Huster KM, Jakob T, Schulz H, *et al.* (2010). Specific CD8 T cells in IgE-mediated allergy correlate with allergen dose dan allergic phenotype. *Am. J. Respir. Crit. Care Med*, Vol. 181, pp. 7-16.
- Akdis CA, Blesken T, Akdis M, Akdis B, Wuthrich B and Blaser K. (1998). Role of IL-10 in specific immunotherapy. *J. Clin Invest*, Vol. 102, pp. 98-106.
- Akdis CA, Blaser K, Akdis M. (2004). Genes of tolerance. *Allergy*, 59:897-913.
- Barwig C, Raker V, Montermann E, Grabbe S, Reske-Kunz AB, *et al.* (2010). Antigen dose-dependent suppression of murine IgE responses is mediated by CD4(-)CD8(-) double-negative T cells. *Clin. Exp. Allergy*, Vol. 40, pp. 891-901.
- Campbell DJ and Ziegler SF. (2007). FOXP3 modifies the phenotypic dan functional properties of regulatory T cells. *Nat. Rev. Immunol*, Vol. 7, pp. 305-310.
- Chen W and Wahl SM. (2002). TGF- $\beta$ : receptors, signaling pathways dan autoimmunity. *Cur. Dir. Autoimmune*, Vol. 5, pp. 62-91.
- Cheng WY, Kuo YH and Huang CJ. (2007). Isolation dan identification of novel estrogenic compounds in yam tuber (*Dioscorea alata* Cv. Tainung No. 2). *J. Agric. Food Chem*, Vol. 55, No. 18, pp. 7350-7358.
- Choi JM, Shind JH, Sohnf MH, Hardingg MJ, Parkd JH, Tobiasovac Z, *et al.* (2010). Cell-permeable Foxp3 protein alleviates autoimmune disease associated with inflammatory bowel disease dan allergic airway inflammation. *PNAS*, Vol. 107, No. 43, pp. 18575-18580.
- Cookson W. (2004). The immunogenetics of asthma dan eczema: a new focus on the epithelium. *Nature Rev. Immunol*, Vol. 4, No. 12, pp. 978-988.
- Diding HP, Endang LS, Subijanto AA. (2008). Pengaruh probiotik terhadap gambaran histologis mukosa usus pada mencit Balb/C model alergi. *J. Kedokteran Yarsi*, Vol. 16, No. 1, pp. 6-12.
- Dourado LP, Saldanha JP, Gargiulio DL, Noviello ML, Brant CC, Reis ML, *et al.* (2010). Role of IL-4 in aversion induced by food allergy in mice. *Cellular Immunology*. Vol. 262, pp. 62-68.
- Dourado LP, Noviello Mde L, Alvarenga DM, Menezes Z, Perez DA, Batista NV, Menezes GB, Ferreira AV, de Souza Dda G, Cara DC. (2011). Experimental food allergy leads to adipose tissue inflammation, systemic metabolic alterations and weight loss in mice. *Cell Immunol*. Vol. 270, No. 2, pp. 198-206.
- Ewan PW. (1998). ABC of Allergies: Venom allergy. *BMJ*, Vol. 316, pp. 1365-1368.
- Fischer R, McGhee JR, Vu HL, Atkinson TP, Jackson RD, Tome D and Boyaka PN. (2005). Oral dan nasal sensitization promote distinct immune responses and lung reactivity in a mouse model of peanut allergy. *Am. J. Pathol*, Vol. 167, pp. 1621-1630.
- Gorelik L and Flavell RA. (2002). Transforming growth factor-beta in T-cell biology. *Nat. Rev. Immunol*, Vol. 2, pp. 46-53.
- Gould HJ and Sutton BJ. (2008). IgE in allergy dan asthma today. *Nat. Rev. Immunol*, Vol. 8, pp. 205-217.
- Gourbeyre P, Denery S and Bodinier M. (2011). Probiotics, prebiotics, dan synbiotics: impact on the gut immune system dan allergic reactions. *J. of Leukocyte Biol*. Vol. 89, pp. 685-695.
- Haghighi HR, Gong J, Gyles CL, Hayes MA, Zhou H, Sanei B, Chambers JR and Sharif S. (2006). Probiotics stimulate production of natural antibodies in chickens. *Clin. and Vaccine Immunol*. Vol. 13, No. 9, pp. 975-980
- Hartl D, Koller B, Mehlhorn AT, Reinhardt D, Nicolai T, Schendel DJ, Griese M and Krauss-Etschmann S. (2007). Quantitative and functional impairment of pulmonary CD4<sub>+</sub>CD25<sup>hi</sup> regulatory T cells in pediatric asthma. *J. Allergy Clin. Immunol*. Vol. 119, pp. 1258-1266.
- Hawrylowicz CM and O'Garra A. (2005). Potential role of interleukin-10-secreting regulatory T cells in allergy and asthma. *Nature Reviews Immunol*, Vol. 5, pp. 271-83.
- Herrick CA and Bottomly K. (2003). To respond or not to respond: T cells in allergic asthma. *Nat. Rev. Immunol*. Vol. 3, pp. 405-412.

Huang CH, Ku CY and Jan TR. (2009). Diosgenin attenuates allergen-induced intestinal inflammation dan IgE production in a murine model of food allergy. *Planta Med*, Vol. 75, No. 12, pp. 1300-1305

Huang CH, Liu DZ and Jan TR. (2010). Diosgenin, a plant-derived sapogenin, enhances regulatory T-cell immunity in the intestine of mice with food allergy. *J. Nat. Prod*, Vol. 73, pp. 1033-1037.

Jan TR, Wey SP, Kuan CC, Liao M H and Wu HY. (2007). Diosgenin, a steroidal sapogenin, enhances antigen-specific IgG2a and interferon-gama expression in ovalbumin sensitized BALB/c mice. *Planta Medica*, Vol. 73, pp. 421-426.

Jutel M, Akdis M, Budak F, Aebischer-Casaulta C, Wrzyszc M, Blaser K and Akdis AC. (2003). IL-10 and TGF- $\beta$  cooperate in regulatory T cell response to mucosal allergens in normal immunity and specific immunotherapy. *Eur. J. Immunol*, Vol. 33, pp. 1205-1214.

Kearley J, Barker JE, Robinson DS and Lloyd CM. (2005). Resolution of airway inflammation dan hyperreactivity after in vivo transfer of CD4<sup>+</sup>CD25<sup>+</sup> regulatory T cells is interleukin 10 independent. *J. Exp. Med*, Vol. 202, pp. 1539-1547.

Kearley J, Robinson DS, Lloyd CM. (2008). CD4<sup>+</sup>CD25<sup>+</sup> regulatory T cells reverse established allergic airway inflammation and prevent airway remodeling. *J. Allergy Clin Immunol*. Vol. 122, No. 3, pp. 617-24.

Lee JH, Yu HH, Wang LC, Yang YH, Lin YT and Chiang BL. (2006). The level of CD4<sup>+</sup>CD25<sup>+</sup> Regulatory T Cells In Paediatric Patients With Allergic Rhinitis and Bronchial Asthma. *Immunol Allergy Clin North Am*, Vol. 26, pp. 233-44.

Lee JH, Ko NY, Kim NW, Mun SH, Kim JW, Her E, Kim BK, Seo DW, Chang HW, Moon TC, Han JW, Kim YM and Choi WS. (2007). Meliae cortex extract exhibits anti-allergic activity through the inhibition of Syk kinase in mast cells. *Toxicol. and Applied Pharmacol*, Vol. 22, pp. 227-234.

Lee HS, Schlereth S, Khdanelwal P and Saban DR. (2013). Ocular allergy modulation tohi-dose antigen sensitization is a Treg-dependent process. *PLOS ONE*, Vol. 8, pp. e757-69.

Li-Weber M and Krammer PH. (2003). Regulation of IL-4 gene expression by T cells dan therapeutic perspectives. *Nature Rev. Immunol*, Vol. 3, pp. 534-543.

Ling E, Smith T, Nguyen X, Pridgeon C, Dallman M, ARbery J, Carr V and Robinson D. (2004). Relation of CD4<sup>+</sup>CD25<sup>+</sup> regulatory T cell-suppression of allergen-driven T-cell activation to atopic status and expression of allergic disease. *Lancet*. Vol. 363, pp. 608-615

Lopes JE. (2006). Analysis of FOXP3 reveals multiple domains required for its function as a transcriptional repressor. *J. Immunol*. Vol. 177, pp. 3133-3142.

Makiyah SNN, Noor Z, Widodo, Rifa'i M and Djati MS. (2014). Ethanol extract of tubers *Dioscorea alata* L. as antiallergic agent on BALB/c mice induced with Ovalbumin. *Int. J. Pharm Bio Sci*, Vol. 5, No. 3, pp. B 214-220.

Mollicaa JQ, Carab DC, D'Auriol M, Oliveiraa VB, Cesar IC, Brdana ~oa MGL. (2013). Anti-inflammatory activity of American yam *Dioscorea trifida* L.f. in food allergy induced by ovalbumin in mice. *J of Functional Food*, Vol. 5, pp. 1975-1984.

Moreira LF. (2006). Estudo dos componentes nutricionais e imunolo'gicos na perda de peso em camundongos com alergia alimentar. (Mestrado). Departamento de Patologia, Faculdade de Medicina, Universidade Federal de Minas Gerais, Belo Horizonte, pp. 99.

Nouri-Aria KT and Durham SR. (2008). Regulatory T Cells dan Allergic Disease, Inflammation dan Allergy - Drug Targets, Vol. 7, pp. 237-52.

Palomares O, Yaman G and Azkur AK. (2010). Role of Treg in immune regulation of allergic disease. *European J. Immunology*, Vol. 40, No. 5, pp. 1232-1240.

Ryanna K, Stratigou V, Safinia N and Hawrylowicz C. (2009). Regulatory T cells in bronchial asthma. *Allergy*, Vol. 64, pp. 335-47.

Saldanha JC, Gargiulo DL, Silva SS, Carmo-Pinto FH, Danrade MC, Alvarez-Leite JI, Teixeira MM and Cara DC. (2004). A model of chronic IgE-mediated food allergy in ovalbumin-sensitized mice, *Braz. J. Med. Biol. Res*. Vol. 37, pp. 809-816.

Sakaguchi S. (2004). Naturally arising CD4<sup>+</sup> regulatory T cells for immunologic self-tolerance dan negative control of immune responses. *Annu. Rev. Immunol*. Vol. 22, pp. 531-539.

Sakaguchi S, Yamguchi T, Nomura T and Ono M. (2008). Regulatory T cell dan immune tolerance. *Cell*. Vol. 133, pp. 775-787

Shevach EM. (2000). Regulatory T cells in autoimmunity. *Annu. Rev. Immunol*, Vol. 18, p. 423-28.

Shreffler WG, Wanich N, Moloney M, Nowak-Wegrzyn A and Sampson HA. (2009). Association of allergen-spesific regulatory T cells with the onset of clinical tolerance to milk protein. *J. Allergy Clin. Immunol*, Vol. 123, pp. 43-52 e7.

- Stock P, DeKruyff RH and Umetsu DT. (2006). Inhibition of the allergic response by regulatory T cells. *Curr Opin Allergy Clin Immunol*, Vol. 6, pp. 12-16.
- Susanti N, Barlianto W, Kalim H, ChandraKusuma HMS. (2013). Asthma Clinical Improvement and Reduction in The Number of CD4+CD25+foxp3+Treg and CD4+IL-10+Cells after Administration of Immunotherapy House Dust Mite and Adjuvant Probiotics and/ or Nigella sativa Powder in Mild Asthmatic Children. *IOSR J. of Dental and Med. Sci.* Vol. 7, No. 3, pp. 50-59.
- Van Oosterhout AJ, Bloksma N. (2005). Regulatory T-lymphocytes in asthma. *Eur Respir J.* Vol. 26, pp. 918-32.
- Vignali DAA, Collison LW & Workman CJ. (2008). How regulatory T cells work. *Nature Reviews Immunology*, Vol. 8, pp. 523-532.
- Wan YY, Flavell RA. (2007). Regulatory T-cell functions are subverted dan converted owing to attenuated Foxp3 expression. *Nature*, Vol. 445, pp. 766-770.
- Wu K, Bi Y, Sun K, Wang C. (2007). IL-10-Producing Type 1 Regulatory T Cells dan Allergy, Cellular dan Molecular Immunology. Vol. 4, pp. 269-75.
- Zhang T, Yang C, Rupa P, Jiang B, Mine Y. (2012). Inhibitory effects of *Quillaja saponin* on IgE-mediated degranulation of rat basophilic leukemia RBL-2H3 Cells. *J. of Functional Food.* Vol. 4, pp. 864-871.
- Zheng Y and Rudensky AY. (2007). Foxp3 in control of the regulatory T cell lineage. *Nature Immunology*, Vol. 8, pp. 457-462.



---

**DENGUE PRONE AREAS IN GAMPING, YOGYAKARTA, INDONESIA  
BASED ON ENVIRONMENTAL CONDITION BY USING SPATIAL  
ANALYSIS**

**Tri Wulandari Kesetyaningsih<sup>a\*</sup>, Sri Andarini<sup>b</sup>, Sudarto<sup>c</sup>, Henny  
Pramoedyo<sup>d</sup>**

*<sup>a</sup>Department of Parasitology, Faculty of Medicine and Health Science, Universitas Muhammadiyah Yogyakarta; Jl Lingkar Selatan, Tamantirto, Kasihan, Bantul, Yogyakarta, 55183, Indonesia*

*<sup>b</sup>Department of Public Health, Faculty of Medicine, University of Brawijaya, Malang, 65145, Indonesia*

*<sup>c</sup>Department of Soil Science, Faculty of Agriculture, University of Brawijaya, Malang, 65145, Indonesia*

*<sup>d</sup>Department of Applied Statistics, Faculty of Mathematics and Natural Science, University of Brawijaya, Malang, 65145, Indonesia*

**Abstract**

Dengue fever is most rapidly spreading disease throughout the world. There is no vaccine and drugs so that eradication relies on vector control. Prediction-prone areas could support the effectiveness of the vector control. This research aims to predict dengue-prone areas based on the environmental factors. The dependent variable was dengue hemorrhagic fever (DHF) cases, while the independent variables were environmental factors such as climate, land cover and elevation. DHF cases were obtained from District Health Office. Climatic data such as temperature, rainfall and humidity were obtained from local Meteorology and Climatology Agency. Land cover was obtained from high resolution imagery. Research unit was the buffer area with a diameter of 200 m patient residence. Quantitative analysis with scoring and weighting methods were used to determine area prone classification. Scoring was based on the distribution of frequency, while the weighting was determined by coefficient correlation ( $r^2$  value). There were 372 DHF cases in sub-district of Gamping in year 2008-2013. The result showed that 68.64% of patient lived in vulnerable and very vulnerable area, 31.36% patient lived in less vulnerable areas. The total area of less vulnerable was 734.396.973 ha, vulnerable area was 609.464.989 ha and the very vulnerable area was 997.717.972 ha. It was concluded that environmental factors can be used to predict prone area, the neighborhood where the patient lived as a research unit can provide information on how many percent of patient living in an area prone classification.

**Keywords**

dengue, prone areas, spatial analysis, environment, neighborhood

---

\* Corresponding author. Tel.: +6281328021233; fax: 62274387658.  
E-mail address: tri\_wulandari@umy.ac.id

## 1. Introduction

Dengue is the viral disease that spread very fast in the world. There were 30-fold incidences in the last 50 years, with new countries of geographic distribution (WHO, 2009). The disease was spread from tropical to the parts of sub-tropical area such as Europe and USA (Karyanti *et al*, 2014), even spread to rural from urban in the last decade (WHO, 2009). There were 50 million dengue infection approximately and 2.5 billion peoples allegedly in the risk due to living in endemic area (WHO, 2004). *World Health Assembly*55 (WHA55) resolution agreed that dengue is the international health problem because of the crossed country spreading of the disease (WHO, 2006).

In Indonesia, DHF have reported since 1968 and tend to increase up to 2013 (Karyanti *et al*, 2014). Geographically, DHF was spread from only one district infected to almost all of districts in 32 provinces of 33 provinces in Indonesia in year of 2009. However, the case fatality rate decreased from 41,4% in 1968 to < 2% in 2000-2009 (DG PP&PL Dept. of Health RI, 2010) even 0,73% in 2013 (Karyanti *et al*, 2014).

*Aedes aegypti* is the main vector and *Aedes albopictus* is secondary vector (de Melo *et al*, 2012) in Asia, including Indonesia. The elimination program was focused on vector control since the lack of antiviral drug and also vaccine (DG PPM&PL RI, 2004; Aryati, 2007). Vector control was highly recommended through environmental management (Supartha, 2008) because of the risk to vector resistant and environmental contamination by chemist material using. The vector control program has been implemented since 1992 (UU No. 23; 1992) in Indonesia but is considered not succesful to date. There were still less than the save number of free larvae number (>95%) to be an outbreak (Ditjen PP&PL Depkes RI, 2010). The unsuccessful vector control may due to the weak coordination among stake holders, also people may bore to do the preventive activity when it was not in transmission season (Kusnanto, 2007). The area prone of DHF was needed to make the preventive activity focused on the target area so that more efficient and effective.

Vector control should base on the environmental situation in the meaning of natural habitat of vector. In *Aedes* - dengue system, the mosquito survival and extrinsic incubation period (EIP) of virus are the important determinant factor of mosquito's vector capacity (Luz *et al*, 2003; Maciel de Frietas, 2010). The survival of *Aedes* related to climate (Mourya *et al*, 2004), the existence of building (Cheong *et al*, 2014) and vegetation around buildings (Sarfranz *et al*, 2012).

This study aimed to determine prone area of DHF based on the environment by using spatial analysis. The result expected to be a reference in vector control target area.

## 2. Materials and Methods

This is an ecological study with observational methods with cross sectional design. The dependent variable was DHF cases in the periods of 2008-2013. The independent variables were land cover, elevation and climate such as rain fall, temperature and humidity. The samples was sufferer from DHF year 2008-2013 notified in district health office. The patients with unclear address were not involved in the study.

### 2.1. Data collection

DHF patients data with their addresses obtained from District Health Office, confirmed with Primary Health Service data in Sub-District. Climate data obtained from the Agency of Meteorology, Climatology and Geophysics of Yogyakarta

Province. Elevation data obtained directly from digital administration map by using GIS properties. Land cover data obtained from high resolution imagery (quickbird) which overlaid with the buffered area of 200m in diameter around patient residence. The percentage of building vs vegetated in buffered area was calculated.

## 2.2. Data analysis

The correlation between DHF cases with climate, land cover and elevation variables were tested by using Multiple Regression, Spearman and Pearson Correlation respectively which have been reported in other paper. Distribution of frequency was used in scoring and the result of correlation test was used to weighting. Spatial analysis conducted by using tiered quantitative methods with scoring and weighting to determine the prone area classification. The result of scoring of all variables showed in Table 1.

Table 1. Result of scoring determination based on distribution of frequency

No	Variable	Criteria	Score
1	Land cover (%)*	> 50	6
		< 50	4
2	Temperature (° C)*	> 30	2
		26-30	6
		< 26	5
3	Humidity (%)*	> 80	5
		70-80	6
		< 70	1
4	Elevation (m)*	< 125	6
		125-300	3
		> 300	1
5	Rainfall (mm/day)*	≥ 25	6
		20-24	5
		15-19	4
		10-14	3
		5-9	2
		< 5	1

\*) source: data analysis

Weighting was done based on the result of analysis as follows (1) climate contribution was 21,8% (multiple regression  $r^2= 0,218$ ), (2) land cover contribution was 66,4% ( $r = 0,815$ ;  $r^2= 0,664$ ), (3) elevation contribution was 6.7% ( $r = -0,260$ ;  $r^2 = 0,067$ ).

## 3. Results and Discussion

### 3.1. Study area

Sub-district of Gamping was one of 17 sub-districts in Sleman, Yogyakarta, Indonesia. Sleman was located in Java Island of Indonesia, lies between  $110^{\circ} 33' 00''$  and  $110^{\circ} 13' 00''$  East longitude,  $7^{\circ} 34' 51''$  and  $7^{\circ} 47' 03''$  South latitude, occupies an area of 57,482 ha. Sleman consist of 17 sub-districts and 86 villages. Based on elevation, Sleman was divided into four classes < 100 m, 100 – 499 m, 500 – 999 m and > 1000 m asl. Gamping was in < 100 m asl class of elevation (District Government of Sleman, 2015).

There was decline in wetland by 0.46% and dryland by 6.6% and increase in yard by 0.7% during the period of 2010-2013. A decline of wetland and dryland with an increase in yard possibly related to the increasing of immigrants. The number of immigrants in 2013 were higher (14,464) than the number of people who moved out (11,121). The consequences of high number of immigrants were increasing need for housing and other facilities thus increasing yards. An increasing of buildings and yard will support the increasing of DHF incidence (Cheong *et al*, 2014).

Gamping sub-district was part of Sleman that bordering with Yogyakarta Municipality, so flourished as centers of education, industry, services and trade. In addition, Gamping was also passed by path of country road which connect Sleman with some port cities like Semarang, Jakarta and Surabaya as the economic path (District Government of Sleman, 2006).

Gamping sub-district has a wet tropical climate with the rainy season on November – April and dry season on May – October. Data obtained from local agency of climatology showed that the highest rainfall was occurred in November-December and the lowest was in July-August in almost every year. The highest temperature was occurred in around October (39,9°C) and the lowest was in July (24,0°C). The highest humidity (88%) was in November-December and the lowest was in July (72%) in periods of 2008-2013.

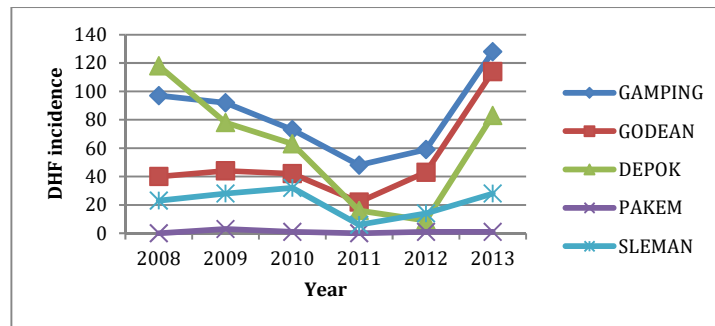

Figure 1. DHF cases in Gamping, compared to the other endemic area in Sleman, Yogyakarta year 2008-2013

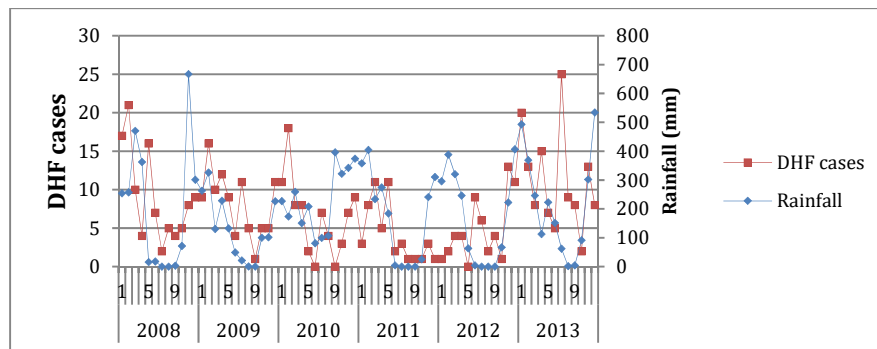

Figure 2. Correlation between DHF cases and cumulative of rainfall in Gamping, Sleman, Yogyakarta year 2008-2013

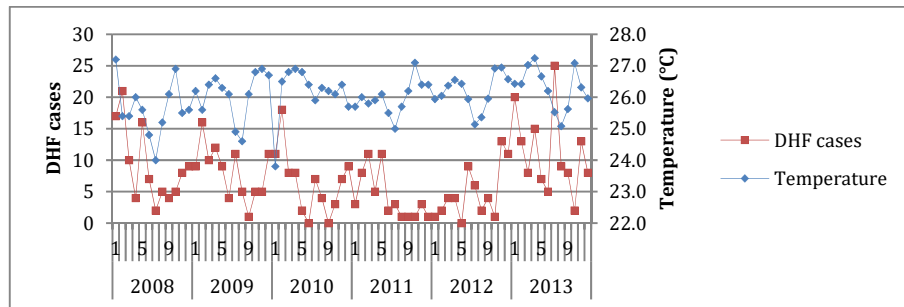

Figure 3. Correlation between DHF cases and temperature in Gamping, Sleman, Yogyakarta year 2008-2013

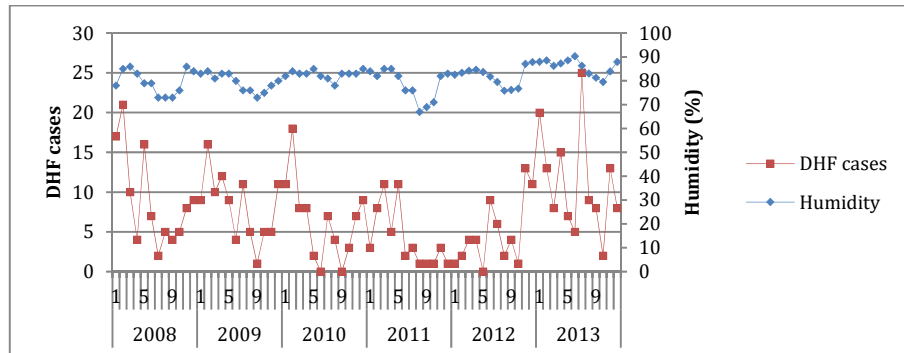

Figure 4. Correlation between DHF cases and humidity in Gamping, Sleman, Yogyakarta year 2008-2013

Figure 1 showed that Gamping was an endemic area with highest incidence in periods of 2008-2013. Therefore it was necessary to make efficient of eradication program especially in Gamping. Figures 2-4 showed the correlation between climate with DHF cases year 2008-2013. It appeared that DHF cases were fluctuated throughout the year with the peak of cases occurred in December-February, except in 2012. Figures 2-4 also showed that DHF cases correlated with climate factors, especially with the humidity. A decrease of DHF cases appeared consistent with a decrease in humidity, but inconsistent with temperature (Fig. 3,4). It seemed that the most incidence of DHF decreased after declining rainfall (Fig.2).

Rainfall increases the number of breeding places of *Aedes* (Supartha, 2008), but actually reduce the number of breeding places if the rainfall is very high (Suroso, 2000 *cit.* Wirayoga, 2013). Rainfall will also increases humidity (Umoh *et al*, 2013), but not necessarily have an impact on temperature. The observation indicate that lowest temperatures was in dry season, and the highest at the beginning of the rainy season does not in the peak of wet season (Fig.3).

### 3.2. Hotspot area of DHF

Mapping of hotspot area has been done by using Kernel Density Estimation (Figure 1A). Kernel density showed the points are concentrated so as to provide for more model of selected site (Donthu and Rust, 1989). In this study, the incidences of DHF in periods of 2008-2013 were concentrated in three hot spot areas. The three areas were in south (Balecatu), center (Ambarketawang) and slightly north part (Nogotirto) of Gamping sub-district. Balecatu and Nogotirto were a rapidly growing areas of settlements, while Ambarketawang was an agglomerated area of Yogyakarta municipality which was growing along with the development of Yogyakarta municipality. Yogyakarta was the center of education (Ramdhani *et al*, 2012) and

tourism destination (Nurhadi *et al*, 2011) in Indonesia, so that significant physical growth. According to Cheong *et al* (2014), the existence of building related with dengue in urban area, and also related with the existence of vegetation in sub-urban area.

### 3.3. Spatial analysis

Spatial analysis has been done with the buffer area of the patient as unit of study. The buffer area represented surrounding environment of patient with diameter of 200 m. The meaning of surrounding environment in this study was the ratio of buildings and vegetation in buffered area which was named as land cover. The other variables were temperature, rainfall, humidity and elevation. As shown at Fig 1(B), the patients year 2008-2013 spread out in almost all regions of Gamping and they most lived in highly vulnerable and vulnerable area of dengue transmission.

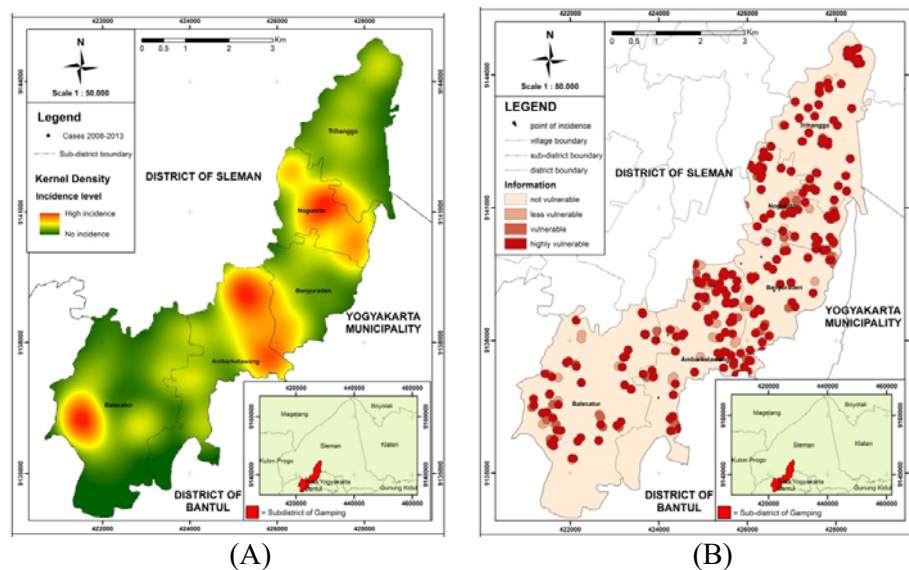

Figure 1. Map of hotspot area (A) and DHF prone area with landcover, temperature, rainfall, humidity and elevation as weighting variables (B) based on DHF patient data year 2008-2013

The result of spatial analysis by using tiered quantitative methods to determine prone area showed that 42.61% patients were live in highly vulnerable area, 26.03% were live in vulnerable area and only 31.36% were live in less vulnerable area (Table 2). It implied that peoples who live in less vulnerable area might be infected by dengue. It was need expected, what is the possibility of infected people in such prone area of dengue.

Table 2. Result of spatial analysis in the form of vulnerable classification and wide area

No.	Total Weight	Classification	Wide (Ha)	%
1.	< 619	Less vulnerable	734.396.973	31,36%
2.	619 – 692,2	Vulnerable	609.464.989	26,03%
3.	> 692,2	Highly vulnerable	997.717.972	42,61%

The incidence of dengue is multi factorial (Murray *et al*, 2013). It was not only related to the environment, but also related to the host and virus. Socio-economic factor (Yussanti, 2010; Hu *et al*, 2012), people mobility (Hu *et al*, 2011) and behavior (Pristi, 2011) are the host factors that are possibly related to dengue fever. The circulating virus may also relate to dengue fever. There were four serotypes of

dengue virus (Izabela *et al*, 2010). Human infected by a type of virus will be immune to such type for life, but will become severe if getting infected again by a different virus type (Sudjana, 2010). Thus, if circulating virus in an endemic area is varied, it will aggravate the endemicity of the area. It was need to be proved further.

#### 4. Conclusion

It was concluded that based on the climate, land cover and elevation, there were 68.64% of patients live in highly vulnerable and vulnerable environment. There were 31.36% patients live in less vulnerable environment.

#### Acknowledgement

We thankful to Universitas Muhammadiyah Yogyakarta for fund the research. We thank to District Health Office for providing patients data. We thank to Agency of Meteorology, Climatology and Geophysics for providing climate data. We also thank to Puji Utami and Riski Agung for spatial data management and doing spatial analysis.

#### References

- Aryati. (2007). Biologi Molekuler Virus Dengue. Aspek Biologi Molekuler, Patogegensis, Manajemen dan Pencegahan Kejadian Luar Biasa. Simposium Nasional Demam Berdarah Dengue (DBD) 16 Mei 2007, Yogyakarta, Indonesia.
- Cheong, Y.L., Leitão, P.J., Lakes, T. (2014). Assessment of land use factors associated with dengue cases in Malaysia using Boosted Regression Trees. *Spatial and Spatio-temporal Epidemiology* 10(2014) 75-84. Elsevier Ltd, doi.org/10.1016/j.sste.2014.05.002.
- de Melo, D.P.O., Scherrer, L.R. and Eiras, A.´E. (2012). Dengue Fever Occurrence and Vector Detection by Larval Survey, Ovitrap and MosquiTRAP: A Space-Time Clusters Analysis. *PLoS ONE* 7(7): e42125. pp 1-14 doi:10.1371/journal.pone.0042125
- Directorate General of PPM&PL, Department of Health, RI. (2004). Kebijakan Program P2-DBD dan Situasi Terkini DBD di Indonesia. Rapat Teknis Penanggulangan DBD (2004), Jakarta, Indonesia.
- Directorate General of PP&PL, Department of Health, RI. (2010). Demam Berdarah Dengue di Indonesia tahun 1968-2009. *Buletin Jendela Epidemiologi*. 2010 Agustus; 2.
- District Government of Sleman. (2006). Profil Kabupaten Sleman. <http://www.slemankab.go.id/profil-kabupaten-sleman/geografi/letak-dan-luas-wilayah>. Last accessed 10 Juni 2013
- District Government of Sleman. (2015). *Sleman Regency in Figures 2014*. Edited by Tim Ahli BPS Kabupaten Sleman, Pemkab. Sleman, Yogyakarta. Pp. 11
- Donthu N and Rust , R.T. (1989). Estimating Geographic Customer Densities Using Kernel Density estimation. *Marketing Science* Vol. 8, No. 2, pp. 191-203
- Hu, W., Clements, A., Williams, G., Tong, S and Mengersen, K., (2012). Spatial Patterns and Socioecological Drivers of Dengue Fever Transmission in Queensland, Australia. *Environ Health Perspect* vol 120, pp.260-266. doi.org/10.1289/ehp.1003270.
- Izabela, A., Zybert, R., Wilschut, J. And Smit, J.M. (2010). Dengue virus life cycle: viral and host factors modulating infectivity. *Cell.Mol.Life Sci.* Vol.67. pp. 2773-2786. doi 10.1007/S00018-010-1357-z.

- Karyanti, M.R., Uiterwaal, C.S.P.M., Kusriastuti, R., Hadinegoro, S.R., Rovers, M.M., Heesterbeek, H., *et al.* (2014). The changing incidence of Dengue Haemorrhagic Fever in Indonesia: a 45-year registry-based analysis. *BMC Infectious Diseases* vol. 14 No.412. pp. 1-7.
- Kusnanto, H. (2007). Surveilans Demam Berdarah Dengue (DBD). In proceeding of Simposium Nasional Demam Berdarah Dengue (DBD): Aspek Biologi Molekuler, Patogegensis, Manajemen dan Pencegahan Kejadian Luar Biasa. Yogyakarta, Indonesia.
- Luz, P.M.; Codeço, C.T.; Massad, E. & Struchiner, C.J. (2003). Uncertainties regarding dengue modeling in Rio de Janeiro, Brazil. *Memórias do Instituto Oswaldo Cruz*, vol.97. pp. 871-878.
- Maciel-de-Frietas, R. (2010). A Review on The Ecological Determinants of *Aedes aegypti* (Diptera: Culicidae) Vectorial Capacity. *Oecologia Australis* vol. 14. No. 3, pp.726-736, Setembro. doi:10.4257/oeco.2010.1403.08
- Mourya, D.T., Yadav, P. and Mishra, A. C., (2004). Effect of Temperature Stress on Immature Stages and Susceptibility of *Aedes aegypti* Mosquitoes to Chikungunya Virus. *Am. J. Trop. Med. Hyg.*, 70(4). Pp. 346–350
- Murray, NEA., Quam, MB and Smith, W. A. (2013). Epidemiology of dengue: past, present and future prospects. *Clin Epidemiol.* 2013; 5: 299–309. doi: 10.2147/CLEP.S344440.
- Nurhadi, Respati, D.S.S., dan Khotimah, N. (2011). Laju Invasi Fungsi Komersial Lahan Pertanian di Koridor Wisata Kraton Yogyakarta – Pantai Parangtritis Provinsi Daerah Istimewa Yogyakarta. *J. Informasi.* Vol. 37. No. 2. Pp. 1-17
- Pristi, A. 2011. *Analisis Faktor Risiko yang Berhubungan dengan Kejadian Demam Berdarah Dengue (DBD) di Kecamatan Tembalang Kota Semarang.* Undergraduate Thesis. Diponegoro University. Semarang, Indonesia
- Ramdhani, S., Istiqomah, E.N., and Ardiyanti, G.K. (2012). The History of Yogyakarta, an Education City. Pp. 21-24. doi: 10.7763/IPEDR. 2012. V58. 5
- Sarfraz, M.S., Tripathi, N.K., Tipdecho, T., Thongbu, T., Kerdthong, P. and Souris, M. (2012). Analyzing the spatio-temporal relationship between dengue vector larval density and land-use using factor analysis and spatial ring mapping. *BMC Public Health.* Vol. 12. No. 853. Pp. 1-19
- Sudjana, P. (2010). Diagnosis Dini Penderita Demam Berdarah Dengue Dewasa. *Buletin Jendela Epidemiologi.* Vol 2. Pp. 21-25
- Supartha, I.W. (2008). Pengendalian Terpadu Vektor Virus Demam Berdarah Dengue, *Aedes aegypti* (Linn.) dan *Aedes albopictus* (Skuse) (Diptera: Culicidae). In Proceeding of Pertemuan Ilmiah Dies Natalis Udayana, 3-6 September 2008. Bali, Indonesia.
- Umoh, A.A., Akpan, A.O. and Jaco, B.B. (2013). Rainfall and Relative Humidity Occurrence Patterns In Uyo Metropolis, Akwa Ibom State, South- South Nigeria. *IOSR Journal of Engineering (IOSRJEN)* e-ISSN: 2250-3021, p-ISSN: 2278-8719 Vol. 3, Issue 8 (August. 2013). pp 27-31.
- World Health Organization. (2004). *Global strategic framework for integrated vector management.* Document WHO/CDS/CPE/2004.10, Last accessed October 2008). [http://whqlibdoc.who.int/hq/2004/WHO\\_CDS\\_CPE\\_PVC\\_2004\\_10.pdf](http://whqlibdoc.who.int/hq/2004/WHO_CDS_CPE_PVC_2004_10.pdf)
- World Health Organization. (2006). *Guidelines for drinking-water quality*, 3rd ed., incorporating first addendum. Last accessed October 2008 [http://www.who.int/water\\_sanitation\\_health/dwq/gdwq3rev/en/index.html](http://www.who.int/water_sanitation_health/dwq/gdwq3rev/en/index.html).
- World Health Organization. (2009). *Dengue: Guidelines for diagnosis, treatment, prevention and control.* WHO press. Geneva, Switzerland. Pp. 10-21.
- Wirayoga, M.A., (2013). Hubungan Kejadian Demam Berdarah Dengue dengan Iklim di Kota Semarang Tahun 2006-2011. *UJPH* 2 (4) (2013). Pp 1-9



Yussanti, N., Salamah, M., Kuswanto, H. (2012). Pemodelan Wabah Demam Berdarah Dengue (DBD) di Jawa Timur Berdasarkan Faktor Iklim dan Sosio-ekonomi dengan Pendekatan Regresi Panel Semiparametrik. Undergraduate Thesis. ITS, Surabaya, Indonesia.

---

**The Effect of Air Freshener Exposure at an Early Age on Alveolar  
Histology of White Rat (*Rattus norvegicus*)**

**Yuningtyaswari<sup>a\*</sup>, Erlina Widyastuti<sup>b</sup>**

<sup>a</sup>Departement of Histology & Biology, Medical Science Study Programe, Faculty of Medicine & Health Science, Universitas Muhammadiyah Yogyakarta; Jalan Lingkar Selatan, Tamantirto, Kasihan, Bantul DIY, Indonesia 55183

<sup>b</sup>Student of Medical Science Study Programe, Faculty of Medicine & Health Science, Universitas Muhammadiyah Yogyakarta; Jalan Lingkar Selatan, Tamantirto, Kasihan, Bantul DIY, Indonesia 55183

---

**Abstract**

Gel and spray air fresheners are chemical products to reduce unpleasant odors in indoor spaces. Most people do not realize the danger behind the air freshener. Chemicals in air freshener (formaldehyde and phthalates), may affect pulmonary function. Infants and children, who vulnerable to pathological effects of air freshener. The research aimed to assess the effect of gel and spray air freshener exposure on alveolar histology of *Rattus norvegicus* at early age. The research design is pure experimental, with the approach of the post-test only control group design. Research subjects are 30 male white rat at early age (7<sup>th</sup> day) (*Rattus norvegicus*) Spraque Dawley, divided into 10 rats for each group gel (P1), spray (P2), and control (K). The exposure of gel and spray air freshener for 67 days up to a maximum dose of 4.5 hours/day, followed by surgery and made preparations for histopathological test. Data is analyzed by Kruskal-Wallis method, followed by Mann Whitney test. Results of the research for thickness of septum interalveolaris and diameter of alveolar, shows that there are significant differences from the control group (K), gel (P1), and spray (P2). The number of inflammatory cells (lymphocytes, PMN, plasma, eosinophils, and histiocytes), in comparison gel group (P1), control (K), and spray (P2) has a significant difference, except PMN cells, eosinophils, and histiocytes in the comparison group gel (P1) and spray (P2). In histopathological test shows that gel air freshener has a worse effect than the spray.

Keywords: histology of alveolar: air freshener; *Rattus norvegicus*

---

\* Corresponding author. Tel.: +628122796167; fax: +62274387658.

E-mail address: yuningtyas@umy.ac.id

## 1. Introduction

Air freshener at this time familiar used to reduce unpleasant odors in an enclosed space. Gel air freshener and spray air freshener more often used in society. In general, people do not be aware of the danger behind the comfortable and fresh sensation emitted by air freshener.

Air freshener contains various volatile organic compound include formaldehyde and phthalates. Formaldehyde is a VOC that is very dangerous for pulmonary (SCHER, 2006) 1. Formaldehyde can cause inflammation and lead to oxidative stress in pulmonary tissue (Lino, A., *et al*, 2011). Di- (2-ethylhexyl) phthalate (DEHP) is a compound derived from phthalates that can cause inflammation in the pulmonary alveoli due to stress oksidatif (Abdel-gawad, S.K. and Atia, T. 2013). Gel air freshener contained more formaldehyde, whereas spray air freshener contained more chemical substances DEHP (SCHER, 2011).

Air freshener can be an agent of indoor pollution due to harmful chemicals. Toxic chemicals emitted by the air freshener mainly will go into the human body through the respiratory system. Particles of harmful substances in the air freshener easily inhaled while breathing and can get stuck in the pulmonary alveoli. Alveolus is a small protrusion like a pocket with a diameter of  $\pm 200 \mu\text{m}$ , which is part terminal bronchi branch and part of the most populous in the pulmonary structure for the diffusion process. Inter-alveolar septum is a wall that is located between two alveoli (Junqueira, C.J., and Carneiro, J. , 2009).

Infants and children are among the groups most vulnerable to the effects of pathological air freshener (Viktor, 2008). If infants and children are more often exposed to air freshener, it can increase the risk of pulmonary alveolar damage due to organ maturation process is not perfect yet. The early phases of pulmonary development in infants is characterized by the active process of septum inter-alveolaris formation (Rahayu, N., 2008).

The research aimed to assess the effect of gel and spray air freshener exposure on alveolar histology of *Rattus norvegicus* at an early age.

## 2. Material and Methods

Subject of this study was 30 male white rat (*Rattus norvegicus*) Sprague Dawley strain, 7 days old at the beginning of treatment. These subject were divided into 10 rats for each group gel (P1), spray (P2), and control (K). Group P1 was treated exposures gel air freshener, brand X. Group P2 was treated exposures spray air freshener, brand X. the control group (K) was not given any treatment. The giving treatment starts at a dose of 15 minutes, 2 times a day. Exposure dose was increased to 15 minutes per exposure per week, to reach a final dose of 4.5 hours (at 67 days of treatment).

On day 68, subjects were sacrificed, followed by pulmonary decision, and made preparations pulmonary histology. Pulmonary histology preparations made by the method of paraffin blocks, with Hematoxylin eosin staining techniques. Preparations pulmonary histology observed with a light microscope at a magnification of 10x10. The histologic features were observed pulmonary alveolar septum thickness, diameter of the alveoli and number of inflammatory cells (lymphocytes, PMN, plasma, eosinophils, and histiocytes). Data is analyzed by Kruskal-Wallis method, followed by Mann Whitney test.

### 3. Result and Discussion

The observation of alveolar histology are presented in tables and pictures below :

Table 1. The average thickness of the septum interalveolaris

Group	Average (m)± Standard Deviation
Control (K)	1,4575±0,19688 <sup>a</sup>
Gel (P1)	8,5650±3,28987 <sup>b</sup>
Spray (P2)	2,9636±0,64212 <sup>c</sup>

<sup>a, b, c</sup> = shows significant differences with statistical test Mann Whitney

Table 2. The average diameter of the alveoli

Group	Average (μ) ± Standard Deviation
Control (K)	15,4151±1,63238 <sup>a</sup>
Gel (P1)	10,1582±1,23627 <sup>b</sup>
Spray (P2)	17,3015±1,13648 <sup>c</sup>

<sup>a, b, c</sup> = showed statistically significant differences with the Mann Whitney test

Table 3. The number of types of inflammatory cells

No	Inflammatory	Average Number of cells ± SD		
		Control (K)	Gel (P1)	Spray (P2)
1	Lymphocytes	4.72±2,301 <sup>a</sup>	116.63±40,919 <sup>b</sup>	35.70±10,944 <sup>c</sup>
2	PMN	7.32±3,085 <sup>d</sup>	19.59±9,187 <sup>e</sup>	20.01±4,304 <sup>e</sup>
3	Plasma	2.66±0,883 <sup>f</sup>	14.82±7,421 <sup>g</sup>	5.19±2,114 <sup>h</sup>
4	Eosinophils	6.03±1,732 <sup>i</sup>	11.72±5,712 <sup>j</sup>	10.30±1,234 <sup>j</sup>
5	Histiocytes	2.10±1,339 <sup>k</sup>	6.51±4,104 <sup>l</sup>	3.33±0,693 <sup>l</sup>

<sup>a-i</sup> = show statistically significant differences with the Mann Whitney test

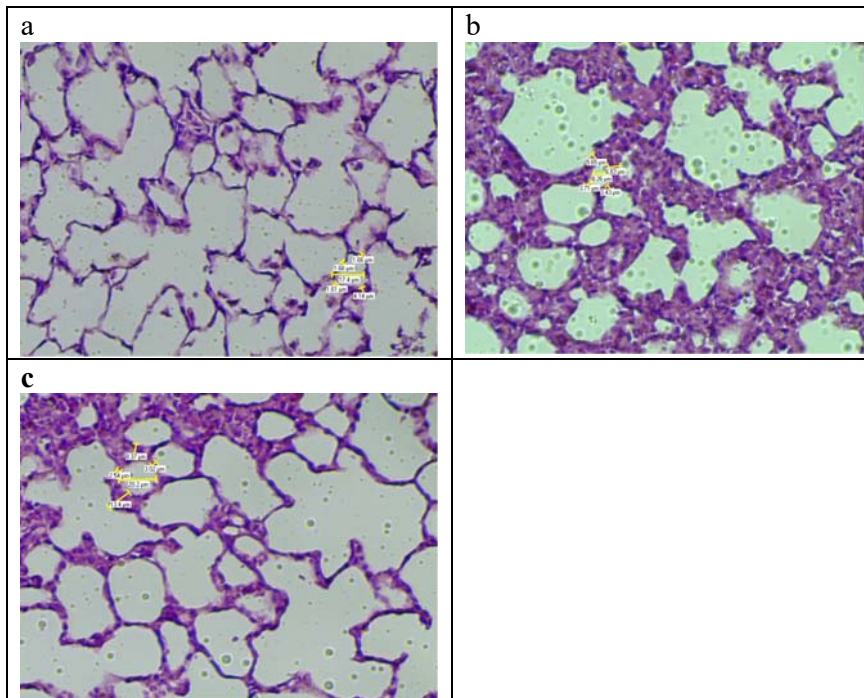

Figure 1. (a) Alveolar histology of Control group (K) (HE, 10x10); (b) Alveolar histology of Gel group (P1) (HE, 10x10); (c) Alveolar histology of Spray group (P2) (HE, 10x10)

This study shows that the effects of exposure to the gel air freshener septum thickness interalveolaris worse than freshener spray. Freshener gels, contain more formaldehyde than the liquid preparation / spray (SCHER, 2006). Mechanisms interalveolaris septal thickening gel group (P1) caused by formaldehyde inhalation causes edema in the tissue around the pulmonary alveoli due to inflammation that occurs through the stimulation of tachykinin NK1 receptors and oxidative stress mechanisms.

In the spray group (P2), interalveolaris septal thickening caused by di- (2-ethylhexyl) phthalate (DEHP) phthalate derivatives which are compounds that are found in room deodorizers liquid / spray1. Compounds that settles in pulmonary DEHP can act as a partial agonist of the Peroxisome Proliferator-Activated Receptor- $\gamma$  (PPAR $\gamma$ ) and stimulate oxidative stress. Both of these mechanisms cause edema septum interalveolaris therefore inflammatory process (Kocbach, A. 2013).

Septal thickening interalveolaris also affected by the process of atelectasis (lung development is not perfect due to alveolar collapse). In this study, atelectasis caused by lung extrinsic pressure increased due to scar tissue (fibrosis) of the septum interalveolaris (Price, S and Wilson, L. M., 2006). As a result of the collapse of the alveoli, the septum adjacent interalveolaris will blend and conjured images of a thickened septum.

The results showed that the average diameter of alveolar spray group > control group > group gel. Alveolar diameter size changes in the gel group, influenced by the effects of formaldehyde in air freshener gels which causes edema and atelectasis. Both processes spur interalveolaris septal thickening, so that will compress the size of the alveoli (Mohamed, A. M. T., et al , 2012). This makes the size of the diameter of the alveoli become increasingly narrow.

This study has shown that alveolar diameter in the spray group (S2), has the widest measure than other groups. This happens because of their exposure to DEHP compound that causes increased production of free radicals (Reactive Oxygen Substance (ROS)) (You,H., et al., 2014). Free radicals can damage cell membranes and protein constituent spur proteolytic degradation of elastin by elastase. Resulting in a drop forming septum interalveolaris woven from fibers elastin and reticuline (Anindyajati, EA., 2007).

Acute inflammatory cells, appears to dominate the control group. Mild acute inflammation that occurs in the control group, may be caused by inhalation of ammonia substances in animal urine test and not caused by exposure freshener. The mechanism of injury occurs when ammonia gas (NH<sub>3</sub>) reacts with tissue fluids to form a highly alkaline solution, called ammonium hydroxide (Permata, G. S., 2011). Acute inflammatory cell infiltration in the gel group (P1) and spray (P2) is not only caused by the substance of ammonia, but also because their mechanism of acute exacerbation of chronic inflammation due to exposure freshener. Acute exacerbation of chronic inflammatory process causing no significant differences between groups of acute inflammatory cells, gel and spray. However, the number of acute inflammatory cells and spray gel group more and has had a statistically significant difference with the control group.

Gel group (P1) and spray (P2) is dominated by chronic inflammatory cells that should be marked by infiltration of lymphocytes, macrophages, and plasma cells are prominent. However, in this study the cell histiocytes (macrophages) and spray gel group has an average amount of at least compared with other inflammatory cells. The condition occurs as a result of this study using formalin 10% (instead of formalin buffer) for organ

fixation process. So that the cells histiocytes become less visible and increase their possibility of cells that are not counted.

#### 4. Conclusion

Exposure air freshener adversely affect alveolar histology in rats (*Rattus norvegicus*) at early age, through observation alveolare septum thickness, alveolar diameter, and the calculation of the number of inflammatory cells. This study also shows that gel air freshener exposure has a worse effect than the spray air freshener.

#### References

- Abdel-gawad, S.K. & Atia, T. 2013. Histological and Ultrastructure Changes Induced by Di {2-ethylhexyl} Phthalate (DEHP) in the Alveolar Tissue of Adult Albino Rats and the Possibility of Recovery. *J Cell Science & Therapy* (Online), Vol. 4, No. 141, <http://omicsonline.org/histological-and-ultrastructure-changes-induced-by-di-2-ethylhexyl-ftalat-dehp-in-the-alveolar-tissue-of-albino-rats-2157-7013.1000141.pdf>, Last accessed 6 April 2014)
- Anindyajati, EA. 2007. *Pengaruh Asap Pelelehan Lilin Batik (Malam) Terhadap Struktur Histologis Trakea dan Alveoli Pulmo, Jumlah Eritrosit Serta Kadar Hemoglobin Mencit (Mus musculus l.)*. Unpublished Thesis. Surakarta : Universitas Sebelas Maret, Indonesia
- Junqueira, C.J., & Carneiro, J. 2009. *Basic Histology (ed. 11)*. USA: The Mcgraw-hill Co. pp. 335-355
- Kocbach, A. 2013. Pulmonary Phthalate Exposure and Asthma – Is PPAR a Plausible Mechanistic Link?. *EXCLI Journal* (Online), Jilid 12, [http://www.excli.de/vol12/Kocbach\\_Bolling\\_20082013\\_proof.pdf](http://www.excli.de/vol12/Kocbach_Bolling_20082013_proof.pdf), Last accessed 1 April 2014)
- Lino, Adriana, Correa, Matheus & Carolina, Ana., 2011. Formaldehyde Induces Lung Inflammation by an Oxidant and Antioxidant Enzymes Mediated Mechanism in the Lung Tissue. *Toxicology Letters* (Online), Vol. 207, No.3, <http://www.sciencedirect.com/science/article/pii/S0378427411015542>, Last accessed 6 April 2014)
- Mohamed, A. M. T., El-Ashtokhy, M., Ahmed, H.,& Ibrahim, O. 2012. Anatomical and Histological Effects of Formaldehyde Inhalation on the Lung of Albino Rat. *Journal of American Science*,(Online), Vol 8, No.9, [http://www.jofamericanscience.org/journals/amsci/am0809/057\\_10494am0809\\_395\\_404.pdf](http://www.jofamericanscience.org/journals/amsci/am0809/057_10494am0809_395_404.pdf), Last accessed 11 April 2014).
- Permata, G. S., 2011. *Gambaran fungsi Paru Pekerja Bagian Produksi Lateks yang Terpajan Amoniak Di PT Socfindo Kebun Aek Pamienke Kabupaten Labuhan Batu Utara Tahun 2010*. Unpublished Thesis. Medan : Universitas Sumatra Utara, Indonesia

- Price S. A., Wilson L. M. 2006. *Patofisiologi – Konsep Klinis Proses-Proses Penyakit Edisi 6*. Jakarta : EGC
- Rahayu, N. 2008. *Buku Ajar Respirologi Anak Edisi Pertama*. Jakarta: Badan Penerbit IDAI. pp. 8-10.
- Scientific Committee on Health and Environmental Risks (SCHER), 2006. Emission of Chemicals by Air Fresheners Test on 74 Consumer Products Sold in Europe. *European Commission* (Online), Vol. 1, No. 19, [http://ec.europa.eu/health/ph\\_risk/committees/04\\_scher/docs/scher\\_o\\_026.pdf](http://ec.europa.eu/health/ph_risk/committees/04_scher/docs/scher_o_026.pdf), Last accessed 9 Februari 2014
- Viktor, 2008. *Bahaya Pengharum Ruangan Buat Anak*. Medan : Dinas Kesehatan Sumatera Barat (Online), <http://www.repository.usu.ac.id/bitstream/123456789/21023/5/Chapter%201.pdf>, Last accessed on 1 April 2014).
- You, H., Chen, Mao, Li, Bing. 2014. The Adjuvant Effect Induced by Di-(2-ethylhexyl) Phthalate (DEHP) is Mediated Through Oxidative Stress in a Mouse Model of Asthma. *Food and Chemical Toxicology* (Online), vol. 71, <http://www.sciencedirect.com/science/article/pii/S0278691514002877>, Last accessed on 6 Oktober 2014

## **Analysis and Design of a Fuzzy Logic Controlled Buck Boost Converter For a Wind Turbine Power Generation**

Wahidin Wahab<sup>1</sup>, Ardie Nirvansyah<sup>1</sup> and Nurul Taufiqu Rochman<sup>2</sup>

*<sup>1</sup>Department of Electrical Engineering, Universitas Indonesia*

*Kampus UI Pondok Cina Depok, Indonesia 16424*

*<sup>2</sup>Nano Center Indonesia, Pusat Inovasi LIPI, Cibinong, 16912, Bogor, Indonesia*

---

### **Abstract**

The problem of the wind Turbine power generator is that the available of wind is unpredictable, and its speed is generally variable in nature, such that the output voltage will be variable at all time, so it is necessary to compensate the power generated when the wind speed is low, by boosting the voltage output, and when the wind speed is high, it should be controlled to reach the required output voltage.

A Microcontroller Arduino UNO is used as the main controller to control the duty cycle of a PWM signal generated to regulate the output voltage of the system. Fuzzy logic control of the Mamdani type algorithm is used in this case. The system has been developed, analyzed, and validated by simulation study using Proteus Design Suite 8.4. and the results show that the target voltage can be regulated very well.

### **Keywords**

buck-boost *converter*, fuzzy logic control, wind turbine, Proteus, Arduino.

---

## **1. Introduction**

As the demand for electricity has been increasing lately, the development for small-scale power plants has been encouraged to meet the community electricity needs. As an alternative, a renewable energy source is used for a small to medium scale power plant. One of the Renewable energy source in this case is the wind turbine power generator. The problem of the wind Turbine power generator is that the available of wind is unpredictable, and its speed is generally variable in nature, such that the output voltage will be variable at all time, so it is necessary to compensate for the power generated. When the wind speed is low, it can boost(step-up) the voltage output, and when the wind speed is high, it should be able to buck(reduced) the voltage output, such that the required output voltage maintained reasonably constant at all time.

A battery array is often used to store the produced electric power but if the charging voltage is varied too much, it may shortened the battery life-time. By using buck-boost *converter*, the fluctuating voltage output from the wind turbine generator can be regulated to the rated value of the battery voltage so that it can be used to charge the battery, and it may not decrease the durability of the battery storage.



This paper is focused on the efforts design and build a buck boost converter to regulate the voltage produced by the wind-turbine in order to achieve a fixed desired output voltage of 12 V at all times

## 2. The Buck Boost Converter

Buck-boost converter is a type of converter that can convert the output voltage to be larger than (Boost-ing) or smaller than (Buck-ing) the input voltage. In this papaer we are considering an inverting buck coot converter, in which the polarity of the output voltage will be opposite to the polarity of its input voltage. The set-up of buck-boost converter is shown in Figure 1. The circuit consists of a switch  $S$  to be controlled, inductor  $L$ , diodes  $D$ , filter capacitor  $C$ , and a load resistor  $R_L$ , which represents the whole load such as batterays and electronic equipments.

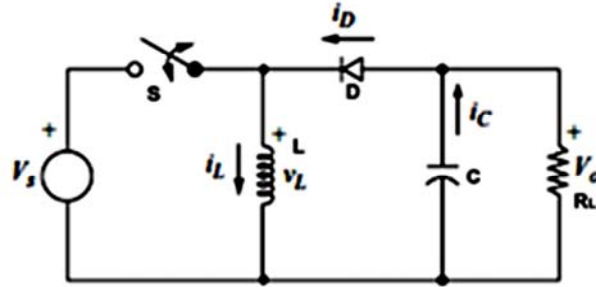

Figure 1. The Buck-Boost converter circuit.

The switch  $S$  is under controlled to “ON” or “OFF” state at the switching frequency( $F_s$ ) of  $1/T$ , where  $T$  is the period, having a ratio of the “ON” condition known as the duty cycle( $DT$ ) that is equal to  $t_{on}/T$ , where  $t_{on}$  is the time interval when the switch is in the “ON” state.

The principle of operation of the buck-boost converter can be described as follows.. In the time interval  $0 < t \leq DT$ , switch  $S$  is “ON” and the diode is “OFF”, is shown in Figure 2. The voltage across the diode is  $-(V_i + V_o)$  and keeping the diode reverse biased in the “OFF” state. The voltage across the inductor is  $V_i$  and add a linear increment in the inductor current with the slope  $V_i/L$ . The voltage across the switch is zero and the diode current is zero. The voltage across the inductor is  $V_L=V_i$ .

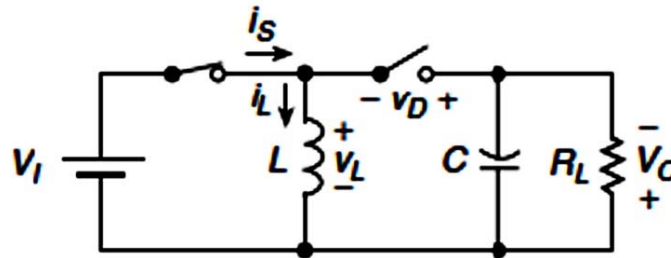

Figure 2. Condition when  $S$  is “ON” and  $D$  is reversed biased at time interval of  $0 < t < DT$ .

The current going through the switch and the inductor  $L$  is given by,

$$i_s = i_L = \frac{1}{L} \int_0^t v_L dt + i_L(0) = \frac{1}{L} \int_0^t v_i dt + i_L(0) = \frac{V_i}{L} t + i_L(0) \quad (1)$$

Where  $i_L(0)$  is the initial current at the inductor  $L$  at time  $t=0$ . So the peak current going through the inductor becomes,

$$i_L(DT) = \frac{V_i DT}{L} + i_L(0) = \frac{V_i D}{F_s L} + i_L(0) \quad (2)$$

The peak to peak current is,

$$\Delta i_L = i_L(DT) - i_L(0) = \frac{V_i DT}{L} = \frac{V_i D}{F_s L} \quad (3)$$

The voltage across the diode is,

$$V_D = -(V_i + V_o) = -V_o \left( \frac{1}{M_{VDC}} + 1 \right) = -\frac{V_o}{D} \quad (4)$$

The peak current at the inductor, is the same as the peak current at the switch, ie.,

$$I_{SM} = I_{L(\text{peak})} = I_i + I_o + \frac{\Delta I_L}{2} \quad (5)$$

This time interval ended when time reaches  $t=DT$ , and the switch is made to "OFF" state by an external driver. Inductor current  $i_L$  is a continuous function of time. The current  $i_L(DT)$  is maintained when the switch is turned on, because the inductor acts as a current source. therefore the diode is turned into an "ON" state.

This condition happens during the time interval  $DT < t \leq T$ , the switch is in "OFF" state and the diode is in the "ON" state, as shown in the Figure 3. The voltage across the inductor is  $-V_o$  and causes the inductor current to decrease linearly with a slope  $-V_o/L$ . The voltage on the switch is  $V_i + V_o$ . The current  $I_D$  flows through the switch and the diode voltage  $V_D$  becomes zero.

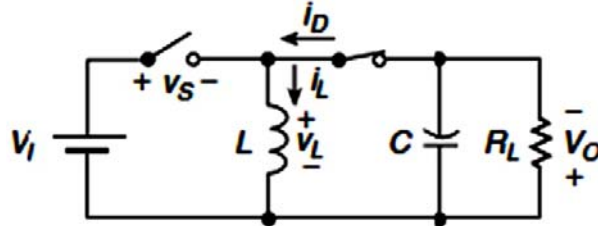

Figure 3. Condition when S is "OFF" and D is forward biased at time interval of  $DT < t < T$

The voltage across the inductor L is  $V_L = -V_o$ , and The current flows through the diode and the inductor is,

$$i_D = i_L = \frac{1}{L} \int_{DT}^t v_L dt + i_L(DT) = \frac{1}{L} \int_{DT}^t (-v_o) dt + i_L(DT) = -\frac{V_o}{L} (t - DT) + i_L(DT) = -\frac{V_o}{L} (t - DT) + \frac{V_i D}{F_s L} + i_L(0) \quad (6)$$

$i_L(DT)$  is the initial current at the inductor at time  $t=DT$ . The peak to peak current going through the inductor L is,

$$\Delta i_L = i_L(DT) - i_L(T) = \frac{V_o T(1-D)}{L} = \frac{V_o(1-D)}{F_s L} \quad (7)$$

The peak voltage at the switch and the diode is,

$$V_{SMmax} = V_{DMmax} = V_{imax} + V_o = \frac{V_o}{D_{min}} \quad (8)$$

The peak current at the switch and the diode is,

$$I_{DM} = I_{L(\text{peak})} = I_i + I_o + \frac{\Delta I_L}{2} = \frac{I_o}{1-D} + \frac{\Delta I_L}{2} \quad (9)$$

And the maximum peak current will be,

$$I_{DMmax} = I_{SMmax} \approx I_{imax} + I_{omax} + \frac{\Delta I_{Lmax}}{2} = \frac{I_{omax}}{1-D_{max}} + \frac{\Delta I_{Lmax}}{2} \quad (10)$$

The Maximum DC current Input occurs when the duty cycle is maximum,  $D_{max}$ , while the maximum ripple current peak-to-peak occurs when the duty cycle is minimum,  $D_{min}$ . At the time  $t=T$  when the switch in "OFF" state is ended then the switch is made return to "ON" state again by an external driver.

From the above equation,  $V_i = V_o (1-D)/D$ . so that<sup>[2]</sup>

$$\Delta I_{Lmax} = i_L(DT) = \frac{V_i DT}{L} = \frac{V_o(1-D_{min})}{F_s L_{min}} \quad (11)$$

Therefore the minimum value of the inductance is given by,

$$L_{\min} = \frac{R_{L\max}(1-D_{\min})^2}{2F_s} \quad (12)$$

The output Section of the buck-boost converter is shown in Figure 4, which is indicated by a capacitance filter with a capacitor C and ESR (Equivalent Series Resistance of the capacitor) symbolized by the  $r_c$ . The DC component of the inductor current will be balancing the DC load current ( $I_o$ ). The AC component of the inductor current flows through the capacitor C and load resistance  $R_L$ .

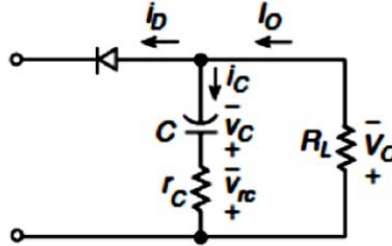

Figure 4. output section of the converter.

The capacitor peak to peak current is

$$I_{C_{pp}} = I_{DM} \approx I_i + I_o = \frac{I_o}{1-D} \quad (13)$$

The capacitor maximum peak to peak voltage is,

$$V_{C_{pp}} = \frac{V_o D_{\max}}{F_s R_{L\min} C_{\min}} \quad (14)$$

The the minimum Capacitance value of the capacitor C is,

$$C_{\min} = \frac{V_o D_{\max}}{F_s R_{L\min} V_{C_{pp}}} \quad (15)$$

### 3. The Fuzzy Logic Controller

The output voltage of the buck-boost converter is controlled by the varying the duty cycle of the PWM signal generated by a microprocessor, which is used to control the length of time the switch S closed as shown in the Figure 5 below.

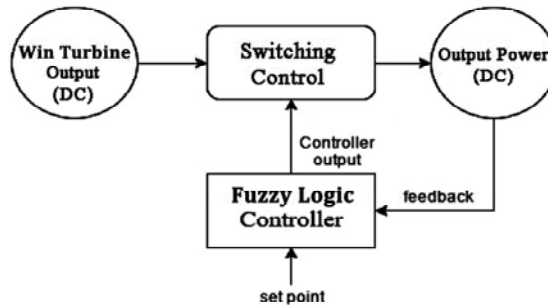

Figure 5. Closed Loop Control of the converter.

In respect to our past experience in designing the controller using a PID type control, which had been succesfull as reported in Wahab2016, in this paper we would like to extend our research to use a more sophisticated controller, such as the Fuzzy Logic controller. This is also due to the fact of having a non-linear switching characteristics of the buck boost converter. The fuzzy logic controller is shown in the Figure 6 below. And implemented using a microprocessor Arduino-Uno.

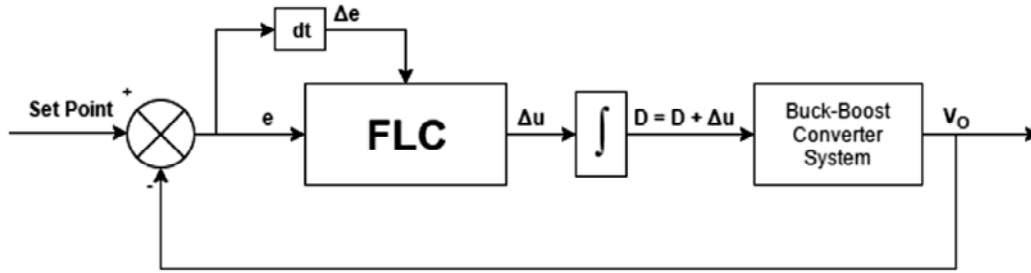

Figure 6. the Fuzzy Logic Controller set-up for closed loop control.

The Fuzzy logic system itself consists of four important components, which are: fuzzification, Knowledge base, inference mechanism, and defuzzification. As shown in figure 7 below. At the fuzzification process, it takes the crisp inputs of error and the change of error, and convert them in to fuzzy quantity using the membership functions defined at the input stage. The Output Voltage  $V_o$  value is read, and sent to the micro controller, and then compared to the setpoint, the error and change of error are calculated as :

$$\text{CurrentError} = \text{VoltageSet} - \text{ActualVoltage} \quad (16)$$

$$\text{ChangeOfError} = \text{CurrentError} - \text{PastError} \quad (17)$$

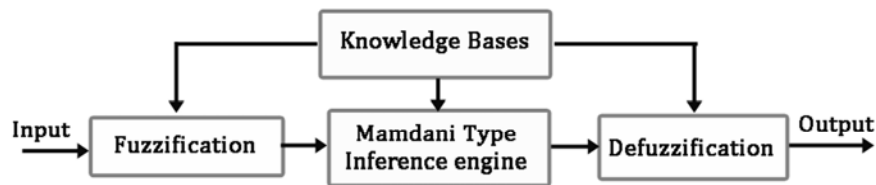

Figure 7. the four component inside the Fuzzy Logic system.

These two information is then fed in to the Fuzzy logic controller, to be fuzzified, using the membership function defined in the FLC for the Error( $e$ ) and the Change of Error( $\Delta e$ ) as shown in figure 4 below, each group contained only five triangular shaped membership functions, which named NB(=Negative Big), NS(=Negative Small), ZZ(=Zero), PS(=Positive Small) and PB(=Positive Big) with appropriate normalized scales.

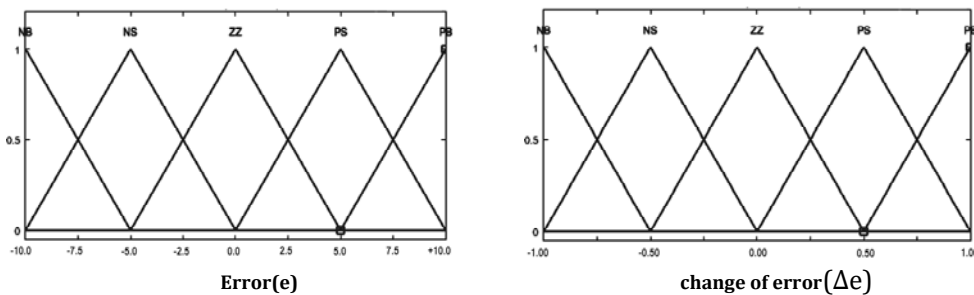

Figure 8. Membership Function at input stage for Error and Change of Error.

At the output stage, the FLC uses 9(nine) triangular membership functions as shown in figure 9 below in order to have more variations to the out put stage. The memberships are NVB(Negative Very Big), NB(Negative Big), NM(Negative Medium), NS(Negative Small), ZZ(Zero), PS(Positive Small), PM(Positive Medium), PB(Positive Big) and PVB(Positive Very Big).

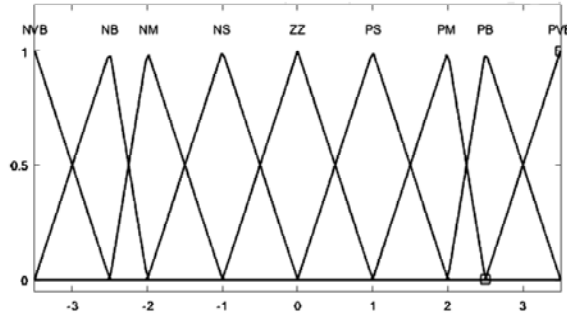

Figure 9. Membership Function at output stage.

In the knowledge base, it contains fuzzy rules in the form of IF-THEN rules as for example, one of the rule is as follows :

**IF Error IS NB AND ChangeOfError IS PS THEN output IS NS**

There are 25(twenty five) such rules are entered in the fuzzy knowledge base, as listed in the table 1 below, and it will be used by the Inference engine to deliver a conclusion of the rules, the inference engine applied in this work is the mamdani type inferences or The Max-Min inferences.

Table 1. A table of the Fuzzy rules in the knowledge base

		$\Delta e$									
		NB	NS	ZZ	PS	PB					
e	PB	ZZ	1	PS	2	PM	3	PB	4	PVB	5
	PS	NS	6	ZZ	7	PS	8	PM	9	PB	10
	ZZ	NM	11	NS	12	ZZ	13	PS	14	PM	15
	NS	NB	16	NM	17	NS	18	ZZ	19	PS	20
	NB	NVB	21	NB	22	NM	23	NS	24	ZZ	25

At the Defuzzification proses, the Fuzzy logic system will convert the fuzzy quantity from the output of the inference engine, in to a crips quantity, such that it can be use by the controller, the defuzzification method uses the Centre of Area (CoA) as follows.

$$CoA = \frac{\int f(x).x.dx}{\int f(x)dx} \quad (18)$$

The x is the fuzzy variable, and the integration is taken for the whole range of the inference result. The CoA is a crips quantity representing the value to be used as the increment or decrement of dutycycle( $\Delta D$ ), by appropriate de-scaling in the algorithm. The control output is  $u = (D_{(k-1)} + \Delta D)$ , that will change the duty cycle of the PWM signal used to control the switching of the switch S.

#### 4. The Circuit Design

The design of the buck-boost converter is done by first determining the values of each type of component using the equations (12) to (15) given before, then the appropriate component values are adjusted to the nominal values that available in the market. The design is based on the specification listed in table 2. below. And the results of the design calculation is given in table 3 below. The switch S is replaced by a MOSFET Transistor IRF7233 which is capable of high current flow. The MOSFET is driven by a BJT transistor 2N2222 to quarantee the proper switching of the MOSFET since the PWM signal output from the microcontroller is very small, so that this BJT transistor may

provide the required current to drive the MOSFET to go in to saturation when switching occurs.

Table 2. The Design Specification Parameter

Description	specification
The minimum input Voltage $V_{i(\min)}$	5 V
The maximum input Voltage $V_{i(\max)}$	50 V
The output voltage $V_o$	12 V
The Target Load Resistance	3.6 $\Omega$
The minimum output current $I_{o(\min)}$	2 A
The maximum output current $I_{o(\max)}$	5 A
The Minimum output Power $P_{o(\min)}$	50 W
The Maximum output Power $P_{o(\max)}$	100 W
switching frequency (fs)	7812,50 Hz
Ripple Voltage ( $\Delta V_o$ )	< 1% of $V_o$
Minimum Duty cycle $D_{\min}$	0,20
Maximum Duty cycle $D_{\max}$	0,80

Table-3. Design Results for component values.

Description	specification
The rated output current $I_o$	3.0 Amp
The load resistance (RL)	3.6 Ohm
The minimum value of Inductance ( $L_{\min}$ )	220 $\mu\text{H}$
The peak-to-peak inductor current $\Delta iL(\min)$	3,20 A
The maximum current input $I_i(\max)$	9 Amp
The Output Capacitance ( $C_{out}$ )	4000 $\mu\text{F}$

## 5. Experiment Results and Discussions

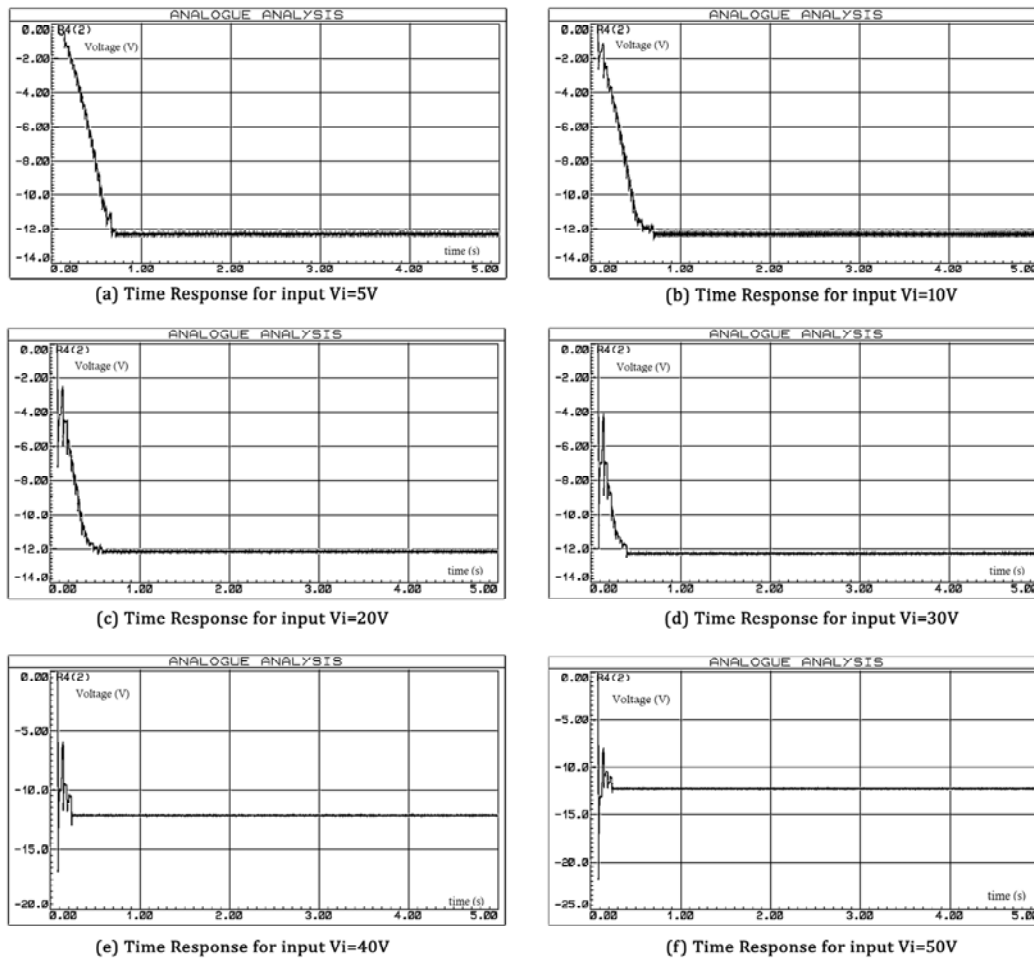

Figure 10. the time response results for inputs 5V to 50V.

The experiments are done for several cases where the input voltage applied is set to start from as low as 5 V, then increases to 10 V, 20 V and so on until reaching as high as 50 V. The value of the input voltage is set to constant value for each experiment as a step function in order to see the transient response time and the settling time of the output characteristics. The experiment results are shown in figure 10. And all the output voltages are in the negative value due to the fact that this is an inverting-type Buck boost converter.

It is shown that for input voltage from 5V to 10 volts, the output voltage may achieved 12.4Volts with a settling time of 0.7 seconds, and the ripple is 0.1V as required. When the input voltage is 20V to 30V, the settling time reduced to 0.4-0.5 seconds and the output voltage reach 12.2V. the experiment with input voltage 40V and 50V, the output voltage is 12.2V to 12.3V for with the settling time is less than 0.4 seconds, but there are high peaks voltage during the transient response. For all experiments the ripple can be as small as 0.1 volt as expected and the transient time tends to be longer when the input voltage is lower than the value of the desired output voltage.

## 6. Conclusions

This paper has presented the design of a buck-boost converter to meet the specifications using the available components in the market. The output voltage of the Wind Turbine can be well regulated by the converter to achieve the voltage around 12.2V to 12.4V such that it can be used for charging the batteries as required. The ripple voltage can achieved 0.1V as required, the settling time is around 0.4 to 0.7 seconds, the settling time tends to be longer when the input voltage is lower than the value of the desired output voltage.

## Acknowledgements

The authors would like to acknowledge the support of the Nano Center Indonesia, LIPI Innovation Center, Cibinong, 16912, Bogor, Indonesia, with very much appreciation and thanks.

## References

- A-WING International (2012). *High Efficiency Micro Wind Turbine: YWS-500 Wind Luce*. [http://www.awing-i.com/english/500W\\_wind\\_turbine.html](http://www.awing-i.com/english/500W_wind_turbine.html). Diakses 22 Juli 2016.
- Battery University, (2016). BU-403: Charging Lead Acid. [http://batteryuniversity.com/learn/article/charging\\_the\\_lead\\_acid\\_battery](http://batteryuniversity.com/learn/article/charging_the_lead_acid_battery). accessed by 22 Juli 2016.
- Dinniyah, Farah S.. *Simulasi Perangkat Buck-Boost Converter Untuk Panel Surya Dengan Pengendali PID*, thesis(in Indonesian), Universitas Indonesia, Dept.E.E., July 2016.
- Ismail, N. F. N., Hashim, N., Baharom, R. (2011). *A Comparative Study of Proportional Integral Derivative Controller and Fuzzy Logic Controller on DC/DC Buck-Boost Converter*. IEEE Symposium on Industrial Electronics and Applications, 978-1-4577-1417-7/11.
- Nirvansyah A., (2016), *Simulasi Perangkat Buck-Boost Converter Untuk Turbin Angin Dengan Pengendali Logika Fuzzy*, thesis, (in Indonesian), Universitas Indonesia.
- REN21, (2015), Renewable Energy Policy Network for the 21st Century.. *Renewables 2015 Global Status Report*, REN21.
- Sulthan, S. M., Devaraj, D. (2013). *Design, Simulation and Analysis of Microcontroller based DC-DC Boost Converter using Proteus Design Suite*. Proc. of Int. Conf. on Advances in Electrical & Electronics, AETAEE. [Prosiding], Desember 2013.
- W. Hart, Daniel. (2011). *Power Electronics*. Valparaiso University, Indiana: The McGraw-Hill Companies, Inc.,
- Wahab W., Dinniyah,F.S.,and Rochman N.T.,(2016) Design And Simulation Of A PID Controlled Buck Boost Converter For Solar Power Application, International Tropical Renewable Energy Conference (i-TREC) 2016, Bogor, Indonesia, October 2016.

## **Fabrication of CNT microarray for biosensor applications**

Nji Raden Poespawati<sup>a\*</sup>, Tomy Abuzairi<sup>a,b</sup>, Mitsuru Okada<sup>c</sup>, Retno Wigajatri  
Purnamaningsih<sup>a</sup>, Masaaki Nagatsu<sup>b,c,d</sup>

<sup>a</sup>*Department of Electrical Engineering, Universitas Indonesia, 16424, Depok, Indonesia*  
<sup>b</sup>*Graduate School of Science and Technology, Shizuoka University, 432-8561, Hamamatsu,  
Japan*  
<sup>c</sup>*Graduate School of Integrated Science and Technology, Shizuoka University, 432-8561,  
Hamamatsu, Japan*  
<sup>d</sup>*Research Institute of Electronics, Shizuoka University, 432-8561, Hamamatsu, Japan*

### **Abstract**

Microarray technology has become one of the indispensable tools which can be used to identification of bio-molecules in cells, tissues, and disease, such as disease diagnosis, prediction, prevention, and drug discovery. The major advantages of the microarray biosensor are their ability of the simultaneous analysis of thousands parameters on a single platform and minimal sample consumption. Furthermore, carbon nanotubes (CNTs) with their outstanding properties are potential material for many applications including biosensors. To increase the fluorescence detection, the microarray will be established within the three-dimensional (3D) structure. The advantage of the 3D structure CNT for microarray platform is the enhancement of active surface area without sacrificing the size of the device. For instance, the external surface area of one CNT spot is roughly  $\sim 3.14 \times 10^{-5} \text{ mm}^2$ . As arrays of  $100 \text{ mm}^2$  of CNT platform with  $50 \text{ }\mu\text{m}$  spacing, it can contain as many as  $1.82 \times 10^8$  spots that is high-density microarrays. This high-density microarray is powerful tools for the screening of pharmaceuticals, investigation of biomolecule interactions and patient diagnostics. In this paper, the CNT is fabricated in microarray configuration to realize biochip sensor design. The CNT microarray was fabricated by using electron beam lithography for patterning microarray on silicon substrate, RF sputtering for deposit catalyst, and thermal plasma chemical vapor deposition (CVD) for growing vertically aligned CNT.

### **Keywords**

*APPJ; plasma functionalization; CNT; 3D microarray; biosensor applications*

\* Corresponding author. Tel.: +62-21-7270078; fax: +62 – 21- 7270077.  
E-mail address: [pupu@eng.ui.ac.id](mailto:pupu@eng.ui.ac.id)



## 1. Introduction

Carbon nanotubes (CNTs) are nanomaterial carbon allotropes with a high surface-area-to-weight ratio ( $\sim 300 \text{ m}^2\text{g}^{-1}$ ) (J. N. Wohlstadter et al., 2003; L. Dong et al., 1996) and excellent material properties such as electrical conductivities and mechanical strength (M. S. Dresselhaus & P. Avouris, 2001; P. M. Ajayan, 1999). CNTs are attracting much attention due to their outstanding properties, with promising applications in numerous areas such as field-effect transistor (S. J. Tans, et al., 1998), fuel cell (Wang, et al., 2004), lithium-ion battery (C. de las Casas & W. Li, 2012), transparent conductive film (Wu, et al., 2004), including biosensors (F. Lu et al., 2009).

Biosensor based on CNTs compose of three associated elements: (1) bioreceptor; (2) interface (functionalized CNT); and (3) transducer. Bioreceptor is a sensitive biological element (such as enzyme, DNA probe, or antibody) for recognizing the analyte (such as complementary DNA and antigen). To work as biosensor, the CNTs have to functionalize as interface layer because the CNTs structure is remarkably stable so that it is insoluble in most solvents. As a result, functionalization of CNT is necessary to allow a better processing of CNT toward the development of biosensors, and improve the solubility and the selectivity of biomolecules recognition (T. Abuzairi et al., 2015, 2016). The transducer converts the biological event to other measurable signals, such as currents, absorbance, mass or acoustic variables.

In this work, the CNT is fabricated in microarray configuration to realize biochip sensor design. The CNT microarray was fabricated by using electron beam lithography for patterning microarray on silicon substrate, RF sputtering for deposit catalyst, and thermal plasma chemical vapor deposition (CVD) for growing vertically aligned CNT (T. Matsuda, et al., 2009; T. Matsuda, et al., 2008).

## 2. Experimental

Initially, a silicon substrate  $10 \times 10\text{-mm}^2$  was cleaned by piranha solution (40 mL sulfuric acid and 10 mL hydrogen peroxide) for 3 minutes, and rinsed by a mixture of 47.5 mL distilled ionized (DI) water and 2.5 mL hydrofluoric acid (HF) for 1 minute. The Si substrate was then coated with hexamethyldisilazane (HMDS) as pre-resist coating and ZEP-520A as positive electron-beam photoresist by automatic spin coating Suss Delta 80 Gyrset. After that, the Si substrate was baked at  $180^\circ\text{C}$  for 2 minutes. The photoresist layer was patterned by electron beam lithography ELS-7700K with acceleration volatage 80 kV, beam current  $1.5 \times 10^{-9}$  A, and dose time 0.2  $\mu\text{s}$ . To remove pattern photoresist, the substrate was developed by O-Xylen at  $23^\circ\text{C}$  for 2 minutes and 2-propanol for 40 seconds. The pattern result was shown in **Fig. 1(a)**.

The substrate was then deposited by chromium (Cr) thin film as a diffusion barrier layer for 20 seconds and nickel (Ni) film as a catalyst for 60 seconds by a RF magnetron sputtering SVC-700RF in argon gas ambient as illustrated in **Fig.1(b)**. A lift-off process was conducted to remove the positive photoresist film by remover ZDMAC and left behind the array catalyst on the substrate after one day as depicted in **Fig. 1(c)**. Finally, the growth of CNT array was carried out in the plasma thermal CVD at a substrate temperature of  $700^\circ\text{C}$  for 5 min pre-treatment with  $\text{NH}_3$  (150 sccm) followed by 15 min

post-treatment with a mixture of  $\text{NH}_3:\text{C}_2\text{H}_2$  (3:1) and an applied dc bias voltage of -550 V to the substrate stage.

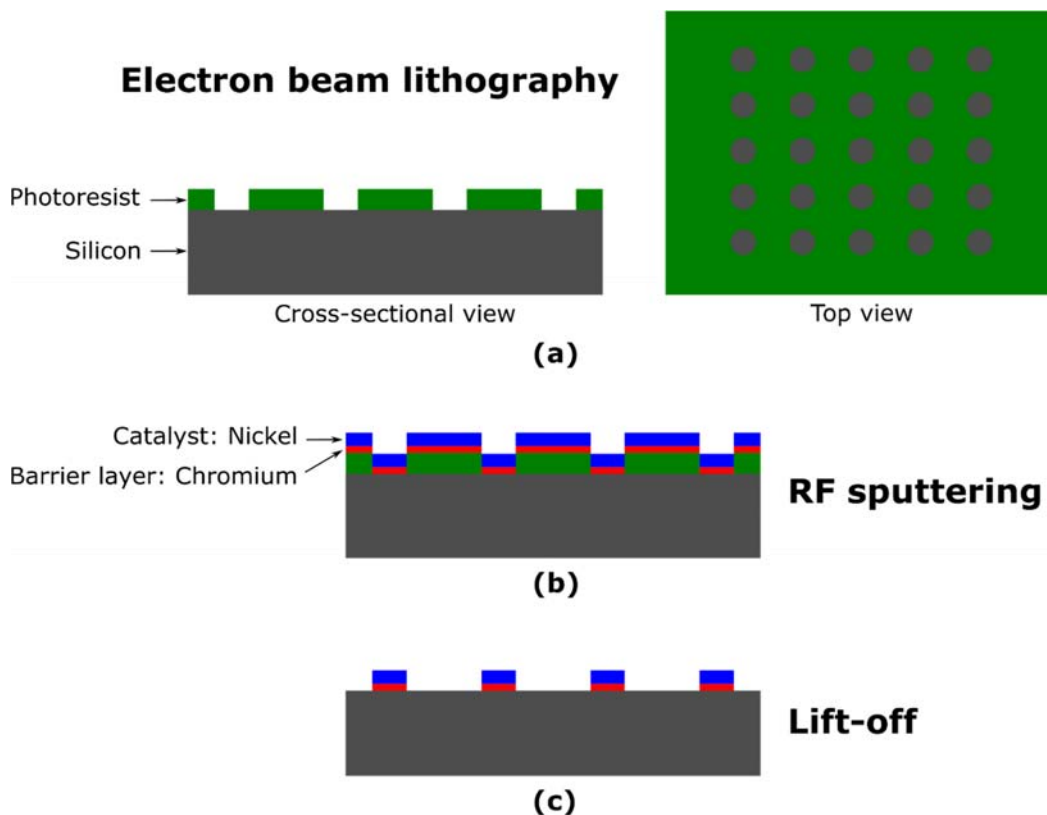

**Figure 1. Fabrication of carbon nanotube microarray. (a) Electron beam lithography. (b) RF sputtering. (c) Lift-off process.**

### 3. Results and Discussion

The CNT were fabricated by using electron beam lithography for patterning microarray, RF sputtering for deposit nickel catalyst, and thermal plasma chemical vapor deposition for growing vertically aligned CNT on the silicon substrate (T. Matsuda et al., 2008). **Fig. 2** depicts an FE-SEM image of the CNT microarray with 50  $\mu\text{m}$  spacing and 5  $\mu\text{m}$  dot size, and magnified image of bundle structure of vertically aligned CNT in cross-section and top views. Each dot consisted of a bundle of multi-walled CNT having a typical length of  $\sim 2$   $\mu\text{m}$  and diameter of about 100 nm. The vertically aligned CNT were fabricated in microarray form to realize the development of biosensor (Kricka, 2001), which has a comparable size of the microarrays biosensor fabricated by other methods, for example photolithography (Malainou, et al., 2012), physical masking (Lee et al., 2010), laser printing method (Duocastella, et al., 2010), micromachine (Bhatnagar, 2007), or microcantilevers processing (Belaubre et al., 2003).

Each CNT spot is comprised of a bundle of multiwall carbon nanotube having a typical length of about 2  $\mu\text{m}$  and a diameter of about 100 nm. The primary advantage of

the 3D structure CNT for biosensor platform is the enhancement of active surface area without sacrificing the size of the device. For instance, the external surface area of one CNT spot is roughly  $\sim 3.14 \times 10^{-5} \text{ mm}^2$ , calculated from the diameter and length of the CNT (5  $\mu\text{m}$  diameter and 2  $\mu\text{m}$  length) (A. Peigney, et al., 2001). As arrays of 100  $\text{mm}^2$  of CNT platform with 50  $\mu\text{m}$  spacing, it can contain as many as  $1.82 \times 10^8$  spots that is high-density biochip microarrays. This high-density microarray is powerful tools for the screening of pharmaceuticals, investigation of biomolecule interactions and patient diagnostics (C. Wingren & C. A. Borrebaeck, 2007; J. Clausmeyer, et al., 2014).

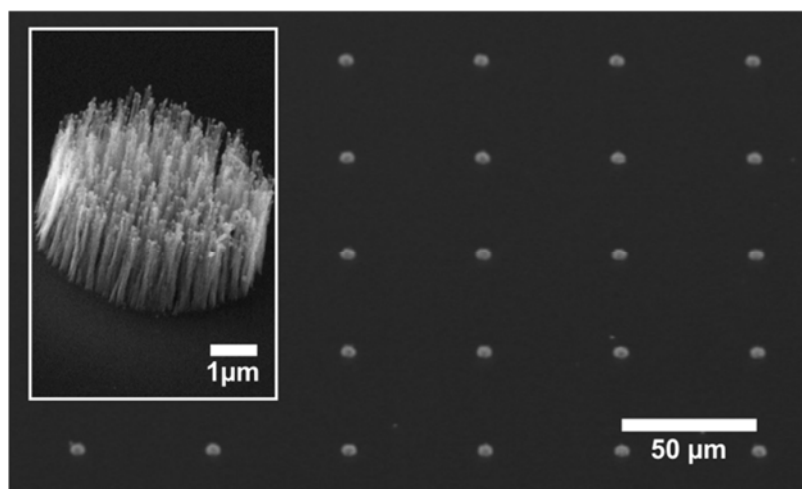

**Figure 2. FE-SEM images of the CNT biochip sensor platform and a magnified image of one spot CNT is shown inset (T. Abuzairi et al., 2016).**

Additionally, based on the calculation of the CNT surface area, the total surface area of one platform is estimated as  $\sim 5715 \text{ mm}^2$ . Therefore, the 3D structure of CNT will enhance surface area as  $\sim 57$  times compared with the 2D structure platform of  $100 \text{ mm}^2$ . From this point of view, CNT materials are great potential for miniaturization the biochip device, which may allow for the detection of currently undetectable disease markers (C. Wingren & C. A. Borrebaeck, 2007; J. W. Silzel, et al., 1998).

#### **4. Conclusion**

The vertically aligned CNT is successfully fabricated by using electron beam lithography for patterning microarray, RF sputtering for deposit nickel catalyst, and thermal plasma chemical vapor deposition (CVD) on the silicon substrate. The 3D structure of vertically aligned CNTs can enhance the active surface area without sacrificing the size of the device. Therefore, CNT materials are great potential for miniaturization the microarray biosensor, which may allow for the detection of currently undetectable disease markers.

#### **Acknowledgements**

This work has been supported by International Research Collaboration and Scientific Publication Grant (DIPA - 042.06.1.401516/2016) from Directorate General of Higher

Education (DGHE) Indonesia. The authors also acknowledge the support of Grant-in-Aid for Scientific Research (A) (No. 25246029) and 209 Scientific Research (B) (No. 26289016) from the Japan Society for the Promotion of Science.

## References

- A. Peigney, C. Laurent, E. Flahaut, R. R. Bacsa, & A. Rousset. (2001). Specific surface area of carbon nanotubes and bundles of carbon nanotubes. *Carbon*, 39(4), 507–514.
- Belaubre, P., Guirardel, M., Garcia, G., Pourciel, J. B., Leberre, V., Dagkessamanskaia, A., ... Bergaud, C. (2003). Fabrication of biological microarrays using microcantilevers. *Applied Physics Letters*, 82(18), 3122–3124.
- Bhatnagar, P. (2007). Multiplexed electro spray deposition for protein microarray with micromachined silicon device. *Applied Physics Letters*, 91(1), 14102.
- C. de las Casas, & W. Li. (2012). A review of application of carbon nanotubes for lithium ion battery anode material. *A Review of Application of Carbon Nanotubes for Lithium Ion Battery Anode Material*, 28, 74–85.
- C. Wingren, & C. A. Borrebaeck. (2007). Progress in miniaturization of protein arrays - a step closer to high-density nanoarrays. *Drug Discovery Today*, 12(19), 813–819.
- Duocastella, M., Fernández-Pradas, J. M., Morenza, J. L., Zafra, D., & Serra, P. (2010). Novel laser printing technique for miniaturized biosensors preparation. *Sensors and Actuators B: Chemical*, 145(1), 596–600.
- F. Lu, L. Gu, M. J. Meziani, X. Wang, P. G. Luo, L. Veca, ... Y.-P. Sun. (2009). Advances in Bioapplications of Carbon Nanotubes. *Advances in Bioapplications of Carbon Nanotubes*, 21(2), 139152.
- J. Clausmeyer, W. Schuhmann, & N. Plumeré. (2014). Electrochemical patterning as a tool for fabricating biomolecule microarrays. *TrAC Trends in Analytical Chemistry*, 58, 23–30.
- J. N. Wohlstadter, J. L. Wilbur, G. B. Sigal, H. A. Biebuyck, M. A. Billadeau, L. Dong, ... S. J. Wohlstadter. (2003). Carbon nanotube-based biosensor. *Advanced Materials*, 15(14), 1184–1187.
- J. W. Silzel, B. Cercek, C. Dodson, T. Tsay, & R. J. Obremski. (1998). Mass-sensing, multianalyte microarray immunoassay with imaging detection. *Clinical Chemistry*, 44(9), 2036–2043.
- Kricka, L. J. (2001). Microchips, microarrays, biochips and nanochips: personal laboratories for the 21st century. *Clinica Chimica Acta*, 307(1–2), 219–223.
- L. Dong, A. B. Fischer, M. Lu, M. T. Martin, D. Moy, & D. Simpson. (1996). Reversible and irreversible immobilization of enzymes on graphite fibrils<sup>TM</sup>. *Journal of Molecular Recognition*, 9(5–6), 383–388.
- Lee, H.-U., Park, S.-Y., Kang, Y.-H., Jeong, S.-Y., Choi, S.-H., Jahng, K.-Y., & Cho, C.-R. (2010). Surface modification of and selective protein attachment to a flexible microarray pattern using atmospheric plasma with a reactive gas. *Acta Biomaterialia*, 6(2), 519–525.
- Malainou, A., Petrou, P. S., Kakabakos, S. E., Gogolides, E., & Tserepi, A. (2012). Creating highly dense and uniform protein and DNA microarrays through photolithography and plasma modification of glass substrates. *Biosensors and Bioelectronics*, 34, 273–281.
- M. S. Dresselhaus, & P. Avouris. (2001). Introduction to carbon materials research. In *Carbon Nanotubes* (pp. 1–9). Springer.
- P. M. Ajayan. (1999). Nanotubes from Carbon. *Nanotubes from Carbon*, 99(7), 1787–1800.
- S. J. Tans, A. R. M. Verschueren, & C. Dekker. (1998). Room-temperature transistor based on a single carbon nanotube. *Room-Temperature Transistor Based on a Single Carbon Nanotube*, 393(6680), 49–52.
- T. Abuzairi, M. Okada, R. W. Purnamaningsih, N. R. Poespawati, F. Iwata, & M. Nagatsu. (2016). Maskless localized patterning of biomolecules on carbon nanotube microarray functionalized by ultrafine atmospheric pressure plasma jet using biotin-avidin system. *Applied Physics Letters*, 109, 23701.
- T. Abuzairi, M. Okada, Y. Mochizuki, N. R. Poespawati, R. W. Purnamaningsih, & M. Nagatsu. (2015). Maskless functionalization of a carbon nanotube dot array biosensor using an ultrafine atmospheric pressure plasma jet. *Carbon*, 89, 208–216.

- T. Matsuda, J. Sato, T. Ishikawa, A. Ogino, & M. Nagatsu. (2009). Field emission characteristics of nano-sized dot array carbon nano-tube emitters fabricated by direct current plasma chemical vapor deposition. *Field Emission Characteristics of Nano-Sized Dot Array Carbon Nano-Tube Emitters Fabricated by Direct Current Plasma Chemical Vapor Deposition*, 18(2-3), 548-552.
- T. Matsuda, M. Mesko, A. Ogino, & M. Nagatsu. (2008). Synthesis of vertically aligned carbon nanotubes on submicron-sized dot-catalyst array using plasma CVD method. *Diamond and Related Materials*, 17(4-5), 772-775.
- Wang, C., Waje, M., Wang, X., Tang, J., & Haddon, R. (2004). Proton exchange membrane fuel cells with carbon nanotube based electrodes. *Proton Exchange Membrane Fuel Cells with Carbon Nanotube Based Electrodes*, 4(2), 345-348.
- Wu, Z., Chen, Z., Du, X., Logan, J., & Sippel, J. (2004). Transparent, conductive carbon nanotube films. *Transparent, Conductive Carbon Nanotube Films*, 305(5688), 1273-1276.

---

**Portable Photovoltaic Powerplant with Solar Tracker for  
Disaster Affected Area Emergency Power Supply**

Indra Riyanto<sup>a\*</sup>, Ade Octaviano<sup>a</sup>, Suparmoko<sup>a</sup>, Kozo Obara<sup>b</sup>

<sup>a</sup>Center for Environmental Studies Budi Luhur University, Jl. Cileduk Raya No. 99 Jakarta Selatan 12260, Indonesia

<sup>b</sup>Institute for Sustainable Development Kagoshima University, Korimoto-cho, Kagoshima, Japan

---

**Abstract**

This paper will discuss about the design of a portable photo voltaic electric generator capable of tracking sunlight in all directions. Such power generator is designed for disaster affected area with power outage, such as during major floods like Jakarta in 2012, or strong earthquake such as Yogyakarta in 2006 and Japan in 2011 (Tohoku) and 2016 (Kumamoto). Such occurrence usually results in disruptions of public service, especially power grids. The system consists of a 10 Wp PV solar panels capable in two axes movement, which is 120° horizontal and 360° azimuth movement with ATmega8535 micro controller as the main controller. Two-axis movement is based on two types of sensors, 360° directional movement is based on the HMC5883 compass sensor. This compass sensor panel also be configured to always directs towards the sun so that if the direction of the base plate was changed, it will automatically direct the panel to the direction of the sun. While 120° vertical movement based on three pieces of LDR (Light Dependent Resistor) as sun sensors. The purpose of this system is to maximize the amount of light received by the panel so the panel power output is also maximized so it can generate emergency electrical supply for lighting and other basic needs.

**Keywords**

Disaster area; Solar Panel; Solar Tracker; Inverter; Emergency Power Generation

---

**1. Introduction**

The use of alternative energy as a power plant lately much discussed, the use of alternative energy is generated by increasing the amount of electrical energy needs. One of the much talked about alternative energy is sunlight. Utilization of sunlight as electrical energy is done by utilizing the so-called solar cell or solar panel. The use of solar panels has been widely used as, for example, street lighting, but the installation of solar panels mostly is made static so that when the sun is not perpendicular to the surface of the panel generated power panels are also less than maximum. This makes the installation of solar panels began to be equipped with a mechanical light tracking, but the movement of the system is only 180° in one axis or as a half circle (Tudorache, 2010) and (Balabel, 2013) with the convex part above, so the placement of this system must always be under the path of the sun's rotation. While others also experimented

---

\* Corresponding author. Tel.: +62-815-900-2864; fax: +62-21-737-1164.  
E-mail address:indra.riyanto@budiluhur.ac.id

with two axis movement, most if not all is still designed for fixed location such as in India (Deb, 2012) and (Dhanabal, 2013), Iran (Bazyari, 2014).

The design aims to complement the mechanical movement of the solar panels into two axes: 120° in vertical axis and 360° azimuth. The movement of the system can be simulated as a hemispherical shape. It is intended that the sunlight is always perpendicular to the surface of the photovoltaic panel.

## 2. System Design

The proposed design is using microcontroller ATmega8535 as the main controller system, two DC motor as the mechanical panel adjuster, compass sensors as position sensors and LDR sensor panels as the vertical axis movement sensor.

After the system start-up, the microcontroller is waiting for the input command to select either automatic or manual mode. If the system is in automatic mode, then the microcontroller will read through the position of the horizontal axis compass sensor to check if the system is already aligned to the direction of the sun or not. If the position is not aligned, then the microcontroller commands the horizontal axis motor to rotate the panels so it is facing to the east. When the east-facing position is achieved, then the microcontroller will read the ADC value from the three LDR light sensors to determine the incident angle of sunlight. The photovoltaic (PV) panel will be facing east if the value of the East LDR is larger than the Center and West LDRs, the PV panel will be tilted towards the west if the ADC value of West LDR is greater than the value of the other two LDRs. However, the position of the vertical axis of the panel will be facing up (90° angle of sunrise) if the value of the East and Center LDRs is greater than the West LDR or when Center and West LDRs greater than East LDR. After panel angle has been achieved, microcontroller will read battery voltage by Zener diode sensor. If the battery in full condition then the microcontroller will switch on the inverter so in this case the load will also be controlled by reading the value of the load, when the load exceeds the inverter output, microcontroller will display "over-load" alert on LCD and disconnect the system temporarily to prevent excessive usage.

### 2.1. LDR Light Sensor Schematics

Solar tracking system design uses LDR as sensors. LDR will be assembled using a voltage divider as shown in Figure 1.

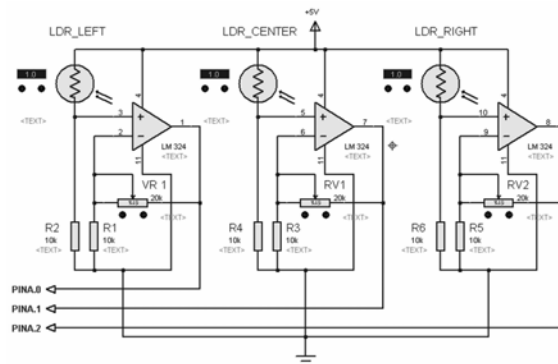

Figure 1. Light sensor schematics

### 2.2. Battery Charging

This circuit uses a relay as the main switch when the battery is fully charged; when the battery is not full then the relay will be off or be in a position normally closed. Sensor for the battery charge is a 12V Zener D1, so when the battery was full the Zener diode will switch the base of the transistor Q2. Q2 is used as an electrical switch that will function to switch ground current from R2, which will light up the LED indicator and will read a logic 0 on microcontroller's C.7 pin. When C.7 pin in the microcontroller receives

logic 0 then the microcontroller will turn on the rightmost relay 1 to be opened up to D1, which normally do not receive the voltage of over 12V.

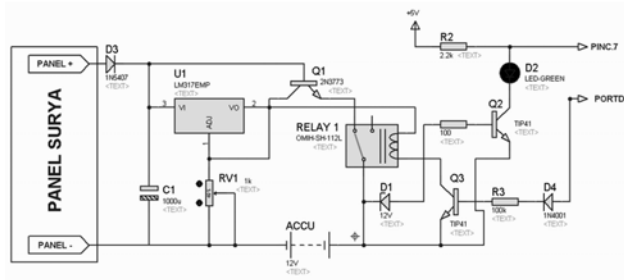

Figure 2. Battery charging schematics

### 2.3. Inverter

Inverters used here is a 4047 IC, MOSFET transistors, 5A transformer, and relays. IC 4047 is used as a square wave generator which will switch the MOSFET transistor IRF540N to perform the push pull transformer, using the MOSFET type transistor inverter is expected to be able to bear loads up to 150 watts. Relay on the inverter is used as switch when battery condition has not yet reached the minimum charge or fully charged the inverter can not be switched on. Figure 3 shows the inverter's schematics.

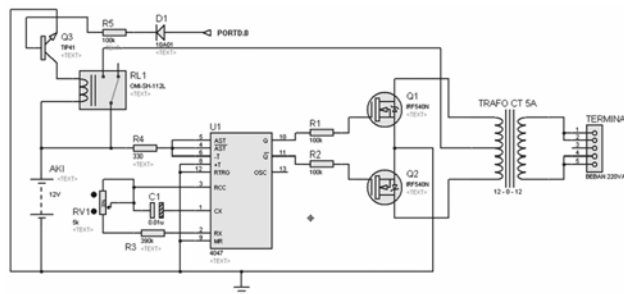

Figure 3. Inverter circuit schematics

## 3. Testing And Analysis

### 3.1. LDR Light Sensor Testing

Testing the sunlight sensor circuit using LDR is done by measuring the voltage at the output of the LM324 which will go into the microcontroller ADC PORT ATmega8535. Table 1 shows the test results.

Table 1. Light Sensor Testing Results

Time	V <sub>out</sub> LDR (volt)			V <sub>out</sub> LM324 (volt)		
	East	Center	West	East	Center	West
09.00-15.00	5.3	4.93	4.98	4.47	4.5	4.3

### 3.2. Inverter Testing

DC to AC inverter testing is done by providing a direct current voltage of 12 volts. In order for DC to AC inverter circuit of 150 watts to work, the voltage supplied 12 volts, and the output section connected by a digital voltmeter and digital ammeters. IC CD4074 is used as a generator. The following Table 2 shows the result of testing 150 watt inverter using a load of three light bulbs of 23 watts each.



Table 2. Inverter Testing Result

Battery status	Load Stats		
	Load 1	Load 2	Load 3
13,6 volt	ON	ON	ON
11.2 volt	ON	OFF	OFF

### 3.3. Solar Cell module Testing

Solar cell testing was conducted from 09:00 to 15:00 with direct measuring of the output voltage on the poles of the solar cell module. Figure 4 shows the measurement scheme and Table 3 shows the measurement result.

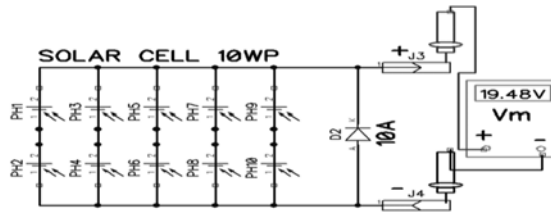

Figure 4. Solar cell module  $V_{out}$  measurement

Table 3. Solar cell module  $V_{out}$  measurement result

Time	$V_{out}$ (Volts)	Sun Elevation (Degrees)	Panel Position
09.00	19.05	45°	East
09.30	19.20	52,5°	
10.00	19.40	60°	
10.30	18.89	57,5°	Center
11.00	19.97	75°	
11.30	20,3	82,5°	
12.00	20,52	90°	West
12.30	20,5	97,5°	
13.00	20.72	105°	
13.30	18.85	112,5°	West
14.00	20.02	120°	
14.30	18.22	127,5°	
15.00	20.35	135°	

Photovoltaic Panel output shows that  $V_{out}$  is stable near maximum of 20 Volts, except for some drops due to cloud cover. Comparison of the output between static and tracker-equipped PV Panel is shown in Figure 5.

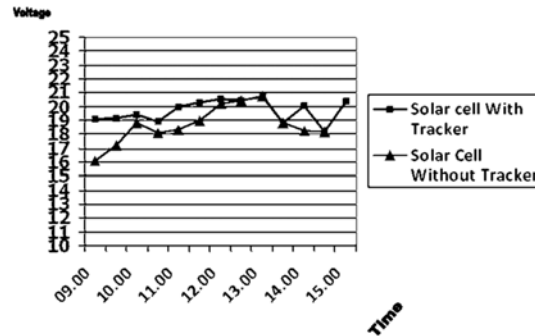

Figure 5. Static and Tracker-equipped panel Vout comparison

#### 4. Discussion

Testing of the completely assembled component focused on the mount with the goals is:

- When the base plate's direction is changed, the panel mount could align itself to the east,
- The panel could trace the elevation of the sun,
- Inverter can support loads,
- Source select switch work properly during overload

From the testing, the base plate can align itself facing toward East direction by 5 degrees per second. Static panel output measured at 16 Volts in the morning compared to 19 Volts when equipped with tracker with both peaked at around 20 to 21 Volts during mid-noon, and then static panel starts to drop again after 13.00 while tracker equipped panel can maintain a steady output voltage.

Calculation for the performance of the system yields the result:

Battery Capacity	= 12V, 5Ah	
Load (PI)	= 46W	(2 × 23W)
Load Voltage (VI)	= 220-240V	
Load current (II)	= 1.13A	

Then the load bearing duration (T):

$$\begin{aligned} \text{Load duration (T)} &= 5 \text{ Ah} / 1.13 \text{ A} \\ &= 4,4 \text{ hours (for two lamps @ 23W each)} \end{aligned}$$

Load testing of the inverter and battery with loads of up to 46 Watts, simulated by a pair of 23W lamps, the stored energy can support the load for over 4 hours. Theoretically, this can last for 5 hours if fully discharged, but the inverter itself also needs energy and will cease functioning when the voltage drops below 9 Volts. This is required to generate square wave for triggering the transistor to perform push-pull and convert DC output from the panel and battery to AC for the load.

#### 5. Conclusion

After the test has been completed, conclusion can be drawn as follows:

- The solar tracker can track the position of sun in horizontal plane (azimuth) and in vertical plane (elevation)
- Tracker can maintain the output of solar panel by align it perpendicular to the direction of incident sunlight

- This tracker is especially designed to be lightweight for portable use on emergency units and may be useful other mobile platforms

## References

- Balabel, A., et al. (2013). Design and Performance of Solar Tracking Photo-Voltaic System; Research and Education. International Journal Of Control, Automation And Systems. Vol.1 No.2. pp.49-55
- Bazyari, S., et al. (2014). A Study on the Effects of Solar Tracking Systems on the Performance of Photovoltaic Power Plants. Journal of Power and Energy Engineering, Vol. 2 No. 2. pp.718-728
- Deb, G., Roy, A.B. (2012). Use of Solar Tracking System for Extracting Solar Energy. International Journal of Computer and Electrical Engineering, Vol.4, No.1. pp.42-46
- Dhanabal, R., et al. (2013). Comparison of Efficiencies of Solar Tracker systems with static panel Single-Axis Tracking System and Dual-Axis Tracking System with Fixed Mount. International Journal of Engineering and Technology. Vol. 5, No. 2. pp.1925-1933
- Tudorache, T. (2010). Design of a Solar Tracker System for PV Power Plants. Acta Polytechnica Hungarica. Vol. 7, No. 1. pp.23-39. Hungary.

---

## **Application of 6A05G Power Diodes in a Simple Yet Effective Voltage Adapter Module for Electric Cars**

Mohammad Nasucha, Hendi Hermawan

*Universitas Pembangunan Jaya, Jl. Cendrawasih, Sawah Baru, Ciputat, Tangerang Selatan  
15413, Indonesia*

---

### **Abstract**

Some types of electric cars use 48V battery. The Rinus C1, the one we developed, uses six eight-volt-battery units connected in series. As this battery's voltage level is higher than the level needed by electrical / electronic devices in the car, a DC/DC converter or a voltage adapter is therefore required. In our case 12V voltage supply is required by the car lightings, electromagnetic door openers, a tablet PC and a multi-purpose USB charger. We have previously developed an efficient 48V/12V switched-mode DC/DC converter however an issue has been recognized: the complexity of on-board cabling of our circuit (although not so complex) rose the risk of module malfunction due to unintended cable displacement by a technician during the eCar assembly and maintenance. Having studied the case, we come to an idea that a simple voltage adapter may fit the need better. For this aim a general-purpose power-diode is predicted to be a good choice for the voltage dropping task considering its current capacity suitability to our client's requirement and its wide availability in the market. The current-voltage characteristics of a power diode (6A05G) is studied. Based on the data obtained, a simple voltage adapter module is successfully developed using a series of diodes as voltage droppers. The module is now used in the car. In addition to that, the module simplicity implies easier, faster and cheaper development.

### **Keywords**

Voltage adapter, DC/DC converter, electric car, Mohammad Nasucha

---

## **1. Introduction**

An electric car usually uses a battery bank with a voltage suitable for the motor and its controller but too high for the rest of the system. The eCar LED lighting, door openers, GPS device and other gadget(s) usually need 12V voltage. Thus, a DC/DC converter or a voltage adapter is required.

For the Rinus C1, the eCar we built, we previously developed a DC/DC converter module and it worked well. However an issue occurred: the complexity of on-board cabling of our circuit (although not so complex) rose the chance of module malfunction due to unintended cable displacement by a technician during the car assembly. Similar situation happened also during eCar maintenance activities. In our case, it happened that the module technically malfunctioned twice for the last two years. Having studied the case, we came to an idea that a simple voltage adapter should fit the need better. In conjunction to its behavior in dropping voltage, a power diode is predicted to be suitable for the task. The questions become: (i) Is it confirmed that the 6A05G power diodes are

able to fit the needs of voltage dropping? (ii) If the answer of question number 1 is yes then can we make a practical and simple voltage adapter module using that diodes?

## **2. Previous Works versus The Proposed Alternative**

It has been proven that the application of switching technique in voltage conversion circuits results in high efficiency. Voltage converters applying this technique have been widely used in many kind of machines or devices, both for industrial and personal uses. Research and development works on the switching concepts and techniques for different supply purposes have been continuing.

In the area of large power DC/DC conversion, the following research works were reported, among others. A research work was reported in (Bai, H. et al. 2012) where they proposed power factor correction for an 11 kW and 10 kW ZVS DC/DC converter for a high-efficiency battery charger in electric vehicles. A research work was also reported in (Andreiciks et al. 2013) where they designed a current source DC/DC converter for Interfacing a 5 kw Pem Fuel Cell.

In the area of small power DC/DC conversion, among others, the following writings addressed the research works that have been carried out. (Hansen and Hill 2000) reported switching regulator charges NiMH Batteries. (Chan-Soo et al. 2011) reported a low-power CMOS DC-DC buck converter with on-chip stacked spiral Inductor. (Fang et al. 2013) addressed the design of a step-down DC-DC converter ASIC applied to portable electronic products. (Mikic et al. 2015) reported the design and characterization of a step-down switched-mode power converter based on the regulator MC34063A. While (Nasucha 2016) addressed the development of a low-power step-down DC/DC converter module for electric cars.

In the area of conception, among others, the following research works were reported. DSP microcontroller-based fuzzy control of a DC/DC parallel resonant converter using phase-shift PWM technique was reported in (Iskender et al. 2006). While a mathematical modelling and analysis of transient and steady states of buck DC-DC converter in DCM was reported in (Babaei and Hamed 2013).

Due to its contribution to high efficiency the switching mode concept has been a favorable choice. Within our project of building an eCar (called Rinus C1), the switching mode concept has been also applied in the first place. A small power switching-mode DC/DC step-down converter module has been developed and used for the eCar for a while. However during the installation and car maintenance this situation was observed: (i) our circuit contained several onboard cables that connected the IC to the power transistors, (ii) during the installation the technician unintentionally broke some of those onboard cables causing circuit malfunction, (iii) during a car maintenance an unintended cable short circuit happened when a solid material was displaced across the converter module. In other words, the module complexity –although it is not so complexed– raised the chance of accidental malfunction.

Having faced the issue, in our case, it is then required to find out an effective solution. There are basically at least three way outs that can be chosen: (i) redesigning the switching-mode circuit so that it will be physically simpler and tidier, (ii) protecting the circuit (module) with a proper case, or (iii) designing and developing the circuit using other technique that allows simplicity.

The first or second solutions surely can be done as long as time permits. However the third choice is literally more challenging in the way that it can be an alternative for future practice. The fact that a diode drops voltage when it flows a forward current is here presumed to be the focal solution. Although it will result in lower conversion efficiency, the solution may still fit the need for a small power voltage converter because the energy loss will be somehow relatively small.

The 6A05G silicon power diode is here predicted to be a good choice considering that its forward current capacity suits client's requirement and that it is widely available in the market. Its price in the market is also inexpensive. For example its price on tokopedia.com in Indonesia today is more or less Rp1000 (8 cent in USD) per piece.

### **3. Method and Materials**

Method applied and the material involved in this work are described in the following sub sections.

#### *3.1. Method*

The work has two goals: (a) to be confirmed that the 6A05G diode is a suitable voltage dropper for the simple voltage adapter module required, and (b) to have the module developed and ready to use. Therefore the whole work will consist of: (i) recognizing the client's requirement, (ii) learning and elaborating the 6A05G's relevant properties, (iii) obtaining actual diode's property values (data) through measurements, (iv) if actual data supports the hypothesis, then proceed with module design and development, and (v) testing the module.

#### *3.2. Materials*

The main component is the 6A05G power diode. If the actual measurements on this diode resulted in a confirmation on the hypothesis, the following components would be required to proceed with module development: resistors, fuses, switches, input terminals, main output terminals and a USB output socket. Measurements for both the diode and the module will be carried out using a digital ampere meter and voltmeter.

### **4. Determining Device Specifications**

The client determined how the eCar would work and look, including what devices to be operating in the car. The researcher / designer then translates it into the device specifications for the Voltage Adapter Module in this regards.

#### *4.1. Load Current Planning*

Because the new module will be placed in the same eCar, with the same load situation, the previous load current planning applies. This is here re-shown by Table 1.

#### *4.2. Module Main Specifications*

In our previous work the module was to be connected to the two poles of the battery bank (48V). However for this work a different approach is taken. Considering that the voltage dropping by the diodes will cause energy loss, the input voltage needs to be brought as low as possible; of course still it has to be higher than the intended output voltage. It is an advantage that the battery bank has a number of terminals (as it consists of six 8-volt batteries) that it can actually serve several voltage values: 8, 16, 24, 32, 40

and 48 volt. Thus, it is decided to supply the module with 16 volt as it will cause least energy loss while it is still higher than the intended output voltage (12V).

The output voltage of the module is to be 12V, as required by the loads: LED lamps and door openers, GPS device, tablet PC, and mobile phone. The Voltage Adapter Module here developed will provide the same voltage (12V) for those as mentioned gadgets through a standard cigarette lighter socket. It means that the gadgets will require their standard 12V/5V converters.

In other words the Voltage Adapter Module is here to be designed based on the same load current planning as the one used in the previous work. It means that the module has to provide up to 5A continuous current at 12V. Table 2 shows this specifications.

#### 4.3. Fuse Specifications

The input current fuse is therefore specified at 5A. The total capacity of the output fuse should ideally equal 5A. However as the output line is split into 4 lines (1.5 A for LED lamps, 1.5A for door openers, 0.65A for cigarette lighter 1, 0.65A for cigarette lighter 2 and another 0.65A for cigarette lighter 3), there should be a practical approach for the situation. Considering also common availability in the market it is decided to use 2A, 2A, 1A, 1A, 1A fuses for the as mentioned lines subsequently. This specifications is shown by Table 3.

Table 1. The load current planning, the same as the one documented in Nasucha (2016), applies.

Load	Charger Rated Output Power	Max. Current at 12V
All LED lamps	18W at 12V	18W / 12V = 1,5A
Door openers	18W at 12V	18W / 12V = 1,5A
Cigarette lighter 1 (GPS or mobile phone charger)	7W at 5.2V	(7w/0.9*) / 12V = 0.65A
Cigarette lighter 2 (Tablet PC charger)	7W at 5.2V	(7w/0.9*) / 12V = 0.65A
Cigarette lighter 3 (Mobile phone charger)	7W at 5.2V	(7w/0.9*) / 12V = 0.65A
		Total current: 4.95A

Table 2. The Module Main Specifications

Input	Output
Vin = 16V	Vout = 12V; Iout = 5A (max)

Table 3. Fuse Specifications

Input Fuse	Output Fuses
Input Fuse: 5A	Output Fuse 1: 2A
	Output Fuse 2: 2A
	Output Fuse 3: 1A
	Output Fuse 4: 1A
	Output Fuse 5: 1A

## 5. The 6A05G's Relevant Properties

Research works on applications of diodes were reported although not specifically addressed their nature of dropping voltage. Application of 1200V-8A SiC JBS diodes in the motor system was reported in (Liu et al. 2013). Whereas characteristics and applications of silicon carbide power devices in power electronics was reported in (Kondrath and Kazimierczuk 2010).

As mentioned the 6A05G is predicted to be a good choice considering: (i) that its forward current capacity is suitable for the module requirement, and (ii) that it is widely

available in the market. The current-voltage characteristics of this type of diode is explained in (Datasheet 2016) and here presented by Figure 1. The curve actually presents an exponential mathematical function that will show itself as a raising curve if drawn on a linear-scaled area. It is depicted by Figure 2.

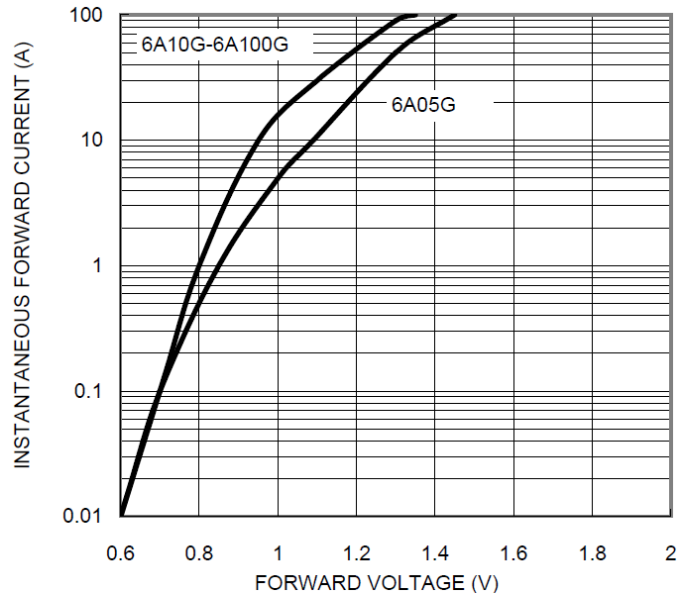

Figure 1. Forward current-voltage characteristics of 6A05G - 6A100G as depicted in (Datasheet 2016). It is shown that the diode starts flowing current when the anode-cathode voltage is around 0.6 volt. The more voltage applied the more current flows, in other words the more current to be flown by the diode the more voltage drops between its anode and cathode. The curve here is drawn on an algorithmic-scaled area.

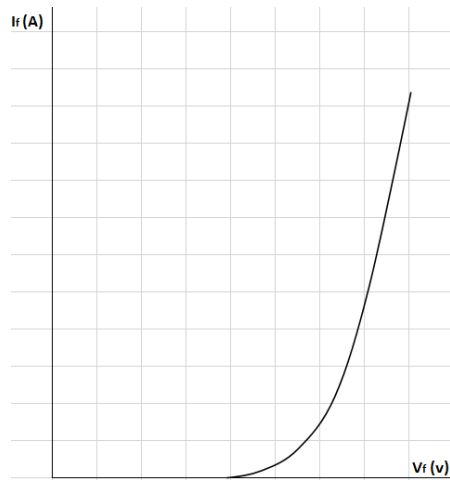

Figure 2. Forward current-voltage characteristics curve of a diode when drawn on a linear-scaled area.

As the information about 6A05G current-voltage characteristics is provided by the datasheet only in graph, the only way to find out the relation between current and voltage at a certain value is doing visual interpolation. This way is shown in Figure 3 whereas the results of this estimation are shown in Table 4. However the real values of voltage for chosen values of current will be known from measurements.



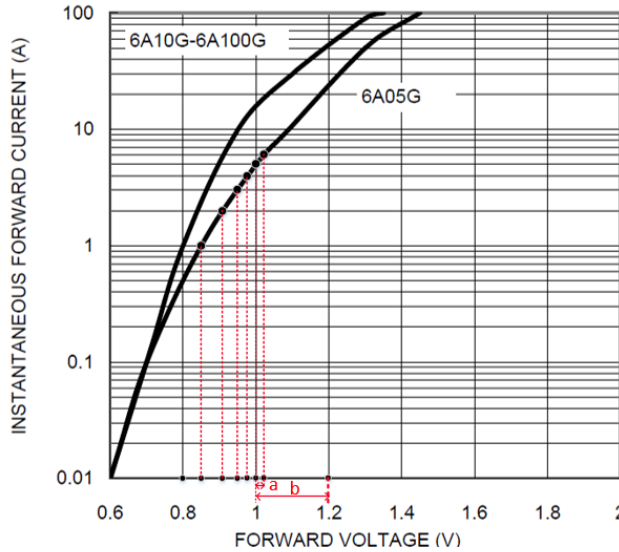

Figure 3. Estimating value of forward voltages for particular forward current values through interpolation.

Table 4. Estimated values of forward voltages for particular forward current values through interpolation as depicted in Figure 2.

Forward Current (A)	1.00	2.00	3.00	4.00	5.00	6.00
Forward Voltage (v)	0.85	0.91	0.95	0.98	1.00	1.02

## 6. Results of The 6A05G Measurement and Discussion

The diode alone was tested. Voltage between anode and cathode was measured for a certain amount of current. For the same current value the measurement were done ten times. The measurement were done for current = 1A, 2A, 3A, 4A, 5A and 6A. The results are shown by Table 5.

Table 5 shows actual forward voltage against forward current at particular values: 1A, 2A, 3A, 4A, 5A and 6A. The diode was supplied with the defined amount of current for 3 minutes –to approach real operational situation where it is heated up– then the anode-cathode voltage was read. The current source was then switched off for another 3 minutes to let the diode cool down. It was then switched on again for the next 3 minutes for the next voltage reading. The cabling was kept untouched during the whole measurement to ensure connection consistency. The room temperature was set around 25°C.

From the results shown, it is found that the drop voltage at the diode rises with the flowing current. The relation between voltage and current is positive but not linear. The portion of voltage increase is less than the portion of the current increase. This current-voltage characteristics is at the same tendency at the one expressed by Figure 2. However the most important message for the project is that these actual diode's drop voltage data will be useful for predicting the total drop voltage that will happen in the module if a certain number of diodes are placed in series.

Table 5. This shows actual forward voltage against forward current of 6A05G at room temperature of 25°C ; current and voltage were read after 3 minute conduction.: (a) Current = 1A, (b) Current = 2A, (c) Current = 3A, (d) Current = 4A, (e) Current = 5A, (f) Current = 6A. The diode was let off the current for 3 minutes before doing the next conduction. For this purpose the power supply was switched on and off while the junctions of the cables were kept untouched during the whole measurement process to ensure connection consistency.

Test No.	Continuous Forward Current (A)	Continuous Forward Voltage (V)	Test No.	Continuous Forward Current (A)	Continuous Forward Voltage (V)	Test No.	Continuous Forward Current (A)	Continuous Forward Voltage (V)
1	1	0.90	1	2	0.96	1	3	1.01
2	1	0.91	2	2	0.97	2	3	1.02
3	1	0.91	3	2	0.97	3	3	1.02
4	1	0.91	4	2	0.97	4	3	1.02
5	1	0.91	5	2	0.97	5	3	1.02
6	1	0.91	6	2	0.97	6	3	1.02
7	1	0.91	7	2	0.97	7	3	1.02
8	1	0.91	8	2	0.97	8	3	1.02
9	1	0.91	9	2	0.98	9	3	1.03
10	1	0.92	10	2	0.98	10	3	1.03
Averaged		0.91	Averaged		0.97	Averaged		1.02
(a)			(b)			(c)		
Test No.	Continuous Forward Current (A)	Continuous Forward Voltage (V)	Test No.	Continuous Forward Current (A)	Continuous Forward Voltage (V)	Test No.	Continuous Forward Current (A)	Continuous Forward Voltage (V)
1	4	1.04	1	5	1.06	1	6	1.08
2	4	1.05	2	5	1.07	2	6	1.08
3	4	1.05	3	5	1.07	3	6	1.09
4	4	1.05	4	5	1.07	4	6	1.09
5	4	1.05	5	5	1.07	5	6	1.09
6	4	1.05	6	5	1.07	6	6	1.09
7	4	1.05	7	5	1.07	7	6	1.09
8	4	1.05	8	5	1.07	8	6	1.09
9	4	1.05	9	5	1.07	9	6	1.09
10	4	1.06	10	5	1.08	10	6	1.09
Averaged		1.05	Averaged		1.07	Averaged		1.09
(d)			(e)			(f)		

Table 6. Voltage predictions for the voltage adapter module that will be developed using the actual data of the Table 5. Actual voltage exists at the second cell of the battery bank usually slightly higher than 16V thus it is approached with 16.6V.

Load Current (A)	Diode's Individual Drop Voltage (V)	Predicted Total Drop Voltage (V) for			Predicted Module Output Voltage If Input Voltage = 16.6V		
		4 Diodes	5 Diodes	6 Diodes	4 Diodes	5 Diodes	6 Diodes
1	0.91	3.64	4.55	5.46	12.96	12.05	11.14
2	0.97	3.88	4.85	5.82	12.72	11.75	10.78
3	1.02	4.08	5.10	6.12	12.52	11.50	10.48
4	1.05	4.20	5.25	6.30	12.40	11.35	10.30
5	1.07	4.28	5.35	6.42	12.32	11.25	10.18
6	1.09	4.36	5.45	6.54	12.24	11.15	10.06

Based on those data, voltage predictions for different options are made and shown by Table 6. A number of diodes are to be placed on board in series. Considering that the required output voltage is around 12V, the application of four diodes is then chosen in order to provide the closest value.

## 7. Result of The Module Development and Discussion

Taking into account the positive findings as discussed in Chapter 6, the 6A05G diodes have been applied for the 18Vdc to 12Vdc voltage adapter module. Four diodes are placed in series. Through a development cycle the module was then finished and ready to test. Figure 4 shows the stages of the development and the test.

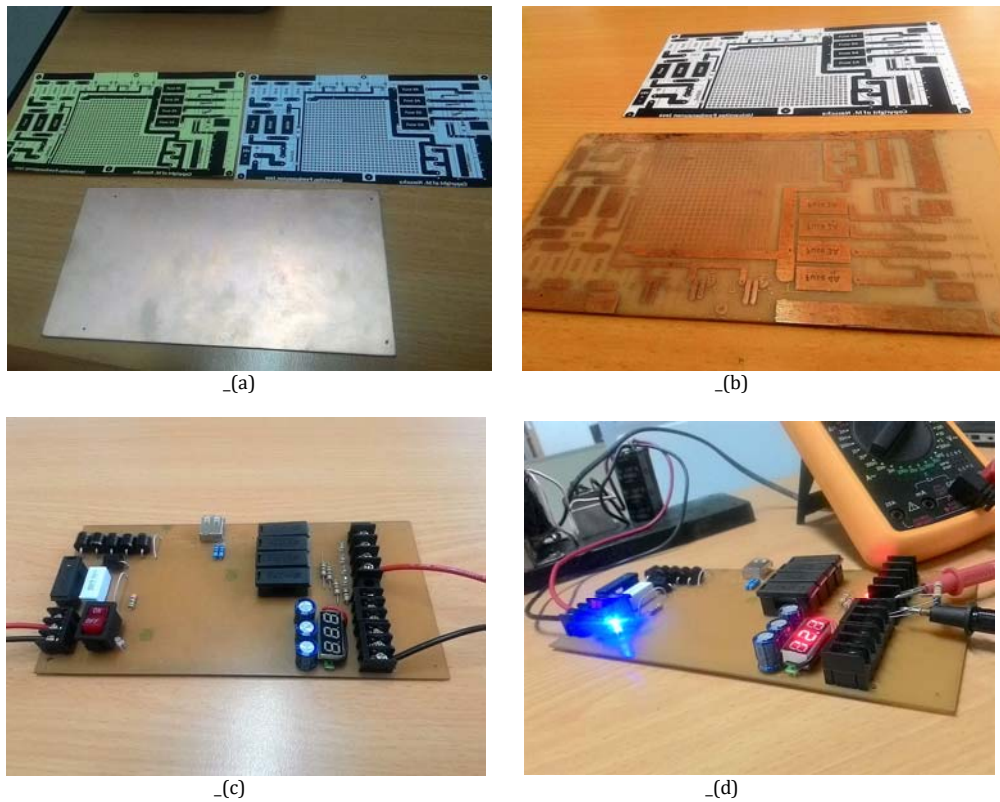

Figure 4. Some photographs taken in the development cycle and the testing: (a) after completion of PCB layout design, (b) after the etching, (c) after the completion of assembling, and (d) when the module was being tested. There are six diodes shown in the picture, two of them are actually being short-circuited (unused). A small modification was also made for the output terminals: USB terminal was provided for the phone charger along with protection resistors.

Upon the completion of the module development, measurements were carried out in operation mode. The results of the measurement are shown in Table 7. It is found that module's output voltage varies with the load current, as predicted.

The voltage decreases when the load current increases. When the current ranges at 1 to 6A the output voltage will range at 12.80 to 11.42V. These values are lower than the prediction (see Table. 6 for the 4 diode option), logically caused by existence of other drop voltages at the protection resistor and at the line on the PCB. Considering that the real requirement –that the devices on the eCar have enough tolerance for the operating voltage– this voltage adapter module would fit the need.

Table 7. The table shows module's output voltage at different loads: (a) I = 1A, (b) I = 2A, (c) I = 3A, (d) I = 4A, (e) I = 5A, and (f) I = 6A at room temperature of 25°C. Four 6A05G diodes were placed in series and the whole onboard circuit resistance was around 0.1 ohm. The values were read when the module was operating for 3 minutes. The current supply to the module was cut for 3 minutes before doing the next operation. The junctions of the cables were kept untouched during the whole measurement process to ensure physical consistency.

Test No.	Load Current (A)	Input Voltage (V)	Output Voltage (V)
1	1	18.36	12.79
2	1	18.36	12.79
3	1	18.36	12.80
4	1	18.36	12.80
5	1	18.36	12.80
6	1	18.36	12.80
7	1	18.36	12.80
8	1	18.36	12.80
9	1	18.36	12.80
10	1	18.36	12.81
Averaged output voltage =			12.80

(a)

Test No.	Load Current (A)	Input Voltage (V)	Output Voltage (V)
1	2	18.36	12.39
2	2	18.36	12.40
3	2	18.36	12.40
4	2	18.36	12.40
5	2	18.36	12.40
6	2	18.36	12.40
7	2	18.36	12.40
8	2	18.36	12.40
9	2	18.36	12.40
10	2	18.36	12.40
Averaged output voltage =			12.40

(b)

Test No.	Load Current (A)	Input Voltage (V)	Output Voltage (V)
1	3	18.35	12.01
2	3	18.35	12.01
3	3	18.35	12.02
4	3	18.35	12.02
5	3	18.35	12.02
6	3	18.35	12.02
7	3	18.35	12.02
8	3	18.35	12.02
9	3	18.35	12.02
10	3	18.35	12.02
Averaged output voltage =			12.02

(c)

Test No.	Load Current (A)	Input Voltage (V)	Output Voltage (V)
1	4	18.35	11.81
2	4	18.35	11.82
3	4	18.35	11.82
4	4	18.35	11.82
5	4	18.35	11.82
6	4	18.35	11.82
7	4	18.35	11.82
8	4	18.35	11.82
9	4	18.35	11.82
10	4	18.35	11.82
Averaged output voltage =			11.82

(d)

Test No.	Load Current (A)	Input Voltage (V)	Output Voltage (V)
1	5	18.34	11.59
2	5	18.34	11.60
3	5	18.34	11.60
4	5	18.34	11.60
5	5	18.34	11.60
6	5	18.34	11.60
7	5	18.34	11.60
8	5	18.34	11.60
9	5	18.34	11.60
10	5	18.34	11.60
Averaged output voltage =			11.60

(e)

Test No.	Load Current (A)	Input Voltage (V)	Output Voltage (V)
1	6	18.34	11.41
2	6	18.34	11.42
3	6	18.34	11.42
4	6	18.34	11.42
5	6	18.34	11.42
6	6	18.34	11.42
7	6	18.34	11.42
8	6	18.34	11.42
9	6	18.34	11.42
10	6	18.34	11.42
Averaged output voltage =			11.42

(f)

The module has been installed onto the eCar successfully and the eCar is currently in normal operations as usual. Several machine maintenance activities have been also carried out and there has been no trouble with the module this far.

## 8. Conclusions

The drop voltage values of a 6A05G diode for different forward current values have been measured in this work. A simple voltage adapter module has been then developed using four diodes that are placed in series. The output voltage of the module is not stable, it decreases when the load current increases. However the module still fits the need. The module offers less physical complexity and therefore is expected to reduce the chance of unintended electrical incident during its installation and maintenance. The extra advantage includes the fact that the module can be developed faster, easier and less costly.

## References

- Andreiciks, A. et al. (2013). Design of Current Source DC/DC Converter for Interfacing a 5 kw Pem Fuel Cell". Latvian Journal of Physics and Technical Sciences, Vol. 50 No. 4, pp. 14-21. Republic of Latvia.
- Babaei, E. and Hamed, M. M. (2013). Mathematical Modelling and Analysis of Transient and Steady States of Buck DC-DC Converter in DCM. COMPEL - The International Journal for Computation and Mathematics in Electrical and Electronic Engineering, Vol. 32 No. 1, pp. 337-363. UK.
- Bai, H. et al. (2012). Design of an 11 kW Power Factor Correction and 10 kW ZVS DC/DC Converter for a High-efficiency Battery Charger in Electric Vehicles. IET Power Electronics, Vol. 5, No. 9, pp. 1714-1722. Institution of Engineering Technology, UK.
- Chan-Soo, L. et al. (2011). A Low-power CMOS DC-DC Buck Converter with On-chip Stacked Spiral Inductor. Microelectronics International Vol. 28, No. 2, pp. 38-43. Emerald, UK.
- Datasheet (2016). 6A05G - 6A100G 6.0 AMPS Glass Passivated Rectifiers. Taiwan Semiconductor, Taiwan. Accessed on February 21<sup>st</sup>, 2016.
- Fang, K. et al. (2013). Design of a Step-down DC-DC Converter ASIC Applied to Portable Electronic Products. Applied Mechanics and Materials, Vol. 311, pp. 255. 2013. Trans Tech Publications, Switzerland.
- Hansen, J. and Hill, J. (2000). Switching Regulator Charges NiMH Batteries. EDN, Vol. 45, No. 26, pp. 95-96. USA.
- Iskender, I. et al. (2006). DSP Microcontroller-based Fuzzy Control of a DC/DC Parallel Resonant Converter Using Phase-shift PWM Technique", COMPEL - The International Journal for Computation and Mathematics in Electrical and Electronic Engineering, Vol. 25 No. 4, pp. 827-840. UK.
- Kondrath, N. Kazimierczuk, M. K. (2010). Characteristics and Applications of Silicon Carbide Power Devices in Power Electronics. Intl Journal of Electronics and Telecommunications Vol. 56, No. 3, pp. 231-236. Warsaw University of Technology, Poland.
- Liu, A. et al. (2013) Application of 1200V-8A SiC JBS Diodes in The Motor System. Applied Mechanics and Materials, Vols. 347-350, pp. 1530-1534. Trans Tech Publications, Switzerland.
- Mikic, M. et al. (2015). Design and Characterization of a Step-down Switched-mode Power Converter Based on the Regulator MC34063A. IEEE Electromagnetic Compatibility Magazine, Vol. 4, No. 4. IEEE Xplore, USA.
- Nasucha, M. (2016). Development of a Low-power Step-down DC/DC Converter Module for Electric Cars. Project Notes (unpublished). Universitas Pembangunan Jaya, Indonesia.

---

**Piperine of *Piper retrofractum* Antagonizes H<sub>1</sub> Receptor: In vitro  
and In silico Study on Isolated-Guinea Pig Ileum Smooth Muscle**

Puguh Novi Arsito<sup>a</sup>, Sabtanti Harimurtia, Ratih Dwi Amaliah<sup>a</sup>

<sup>a</sup> School of Pharmacy, Faculty of Medicine and Health Science, Universitas Muhammadiyah  
Yogyakarta, Jalan Lingkar Selatan, Yogyakarta 55183, Indonesia

---

**Abstract**

Piperine is a major Alkaloid that found in *Piper retrofractum*. Empirically, This herbs used as an antispasmodic. In the previous study. Piperin was reported may inhibit the release of histamine from mast cells by inhibiting the signal pathway mediated by IgE. Based on the fact, piperin was expected to has the antagonism effect on the histamine receptor. The aim of this study was to investigate its activity on H<sub>1</sub> receptor. This research was conducted by investigated the effect of piperin on the guinea pig ileum smooth muscle (in vitro model). Piperin was administered at the doses of 1 mM and 5 mM. The result showed that piperin could inhibit the contraction of isolated guinea pig ileum smooth muscle that induced by histamine. The pD<sub>2</sub> values of H<sub>1</sub> receptor shifted significantly at the dose of 5 mM (p < 0.05). According to the contraction response data, piperin showed non-competitive antagonists activity. Its can observed from the shape of the contraction response curve that was not reach 100% E<sub>max</sub>. Reversibility assay showed that by replaced buffer tyrode every 5 minutes for 30 minutes, the bond of alkaloid to the receptor was able to dissociate. In the in silico study (Autodock), piperine was observed can be bind to H1 receptors (docking score :-5.70). Piperine bound at Lys179 which is one of the important proteins in the histaminergic activity. The conclusion of this research is piperin has the activity as a non-competitive antagonist at the H<sub>1</sub> receptor.

**Keywords**

Piperine, *Piper retroractum*, H<sub>1</sub> receptor, Antagonism

---

**1. Introduction**

Indonesia is known to have a vast biodiversity herbal. Not only used as a spice in cooking, the herb is also sometimes used people as a traditional medicine for various diseases. The availability of various types of spices have the potential to study its contents and used as a guide compounds (lead compound) or the discovery of new drugs. One of the spices that has great potential of medicinal plants is pepper (*Piper nigrum* Linn.) family Piperaceae. This plant comes from India and is growing well in some Southeast Asian countries[1]. Pepper was traditionally used as an analgesic, antipyretic, depressant of central nervous system, anti-inflammatory, antioxidant, anticonvulsant, anti-bacterial, anti-tumor, and has hepatoprotective activity[2]. The major constituent of *Piper nigrum* Linn. is piperine alkaloid (5-9%), volatile oil (1-2.5%), resin (6.0%), piperidine and starch (about 30%)[1].

Some of pharmacological studies of *Piper nigrum* Linn. Have been reported. Alkaloid compound from *Piper nigrum* Linn. Was known has promising activity. The total of 5-9% of alkaloids contained in the pepper was a piperin[3]. Piperine from *Piper nigrum* Linn. Was reported has anti-inflammatory effects in rats that induced by karagenin[4]. From this in-vivo study, indicate that piperine has anti-inflammatory effects, antinociception and antiarthritis by inhibiting multiple inflammatory mediators[5]. On the other hand, the mixture of herbal extract (polyherbal) that containing *Piper nigrum* L. showed bronchodilation effects in mice that induced by ovalbumin[6]. From the In-vitro study showed that piperine inhibits degranulation of the mast cell culture (RBL-2H3) through inhibition of phosphatidylinositol 4-kinase(s)[7]. Its also found the decrease of intracellular  $Ca^{2+}$  levels that play a role in the inhibition of mast cell degranulation[8].

The aim of this study is to determine piperine activity on the ileum smooth muscle contraction. The effect was observed by the selectivity occupation of the histamine receptors. The study was conducted by in vitro methods(organbath). This research is expected to yield data that can be used as a reference for future research.

## 2. Material and Methods

### 2.1. Materials

Piperine alkaloid, Male guinea pigs with a body weight ranging between 400 and 500 grams were obtained from the School of Pharmacy, Universitas Muhammadiyah Yogyakarta. All animal handling protocols were performed in accordance with the guidelines of laboratory animal care of the department. The chemicals used in the study were Tyrode's buffer solution, carbogen gas (containing 95% oxygen and 5% carbon dioxide, obtained from PT. Aneka Gas and Industrial Semarang), histamine (obtained from Sigma, USA), distilled water (obtained from pharmacology laboratory of Universitas Muhammadiyah Yogyakarta).

### 2.2. In Vitro Study

The first step of the assay was to test the effect of 100 mL DMSO on ileal smooth muscle contraction induced by histamine. The purpose of the assay was to ensure that the DMSO used as a piperin solvent would not affect the response of the ileal smooth muscle contraction induced by histamine. Piperin activity as a  $H_1$  receptor antagonist was evaluated by observing changes and shifts in the curve of ileal smooth muscle contraction. The contraction was induced by cumulative concentrations of histamine, ranging from  $2 \times 10^{-8}$  to  $2 \times 10^{-3}$  M.

An organ bath was filled with 20.0 mL of Tyrode's buffer solution, then the organ was placed in the organ bath until a steady state equilibrium was reached (30 min). Subsequently, the single concentration of agonist was introduced to the organ bath and the contraction response was recorded (iwx software). After the contraction reached a plateau, the organ was washed by Tyrode's buffer for 60 min with replacement of the tyrode solution every 15 min. Subsequently, cumulative concentrations of the agonist ranging from  $2 \times 10^{-8}$  to  $2 \times 10^{-3}$  M were added to the organ bath. After maximum contraction, the organ was washed. After a washing period of 60 min, 1 and 5 mM piperine was added to the organ bath at 10 min prior to administration of cumulative concentrations of agonist. After rewashing the organ, this procedure was repeated for each concentration.

A reversibility assay was performed to observe the ability of the organ tissue to return to basal condition after the piperine treatment. The assay was performed to evaluate the reversibility of the interaction between the receptor and its agonist. The

assays were performed before and after the piperine activity assay. The ileum was washed briefly for 30 minutes with Tyrode's buffer solution and with replacement every five minutes. After reaching a stable condition of ileum, the organ was contracted by cumulative concentrations of histamine, after which the contraction response was recorded. The receptor agonist concentration curves before and after treatment with piperine were compared.

### 2.3. *In Vitro Data Analysis*

In the *in vitro* study, the research data concerned ileal smooth muscle contraction. The data were transformed into a percentage of the maximum response achieved by the agonist. Subsequently, the response percentages were plotted against the logarithm of the agonist concentrations.

The EC50 values (concentration of agonist that can produce a response of 50% of the maximum response) of receptor agonist in presence and absence of piperine were calculated based on the curve of the response percentages vs. the logarithm of the agonist concentrations. The EC50 was calculated based on Equation 1 and then transformed into a pD2 value (Equation 2). The data were then represented as mean of pD2 agonist  $\pm$  standard error (pD2  $\pm$  SE). The pD2 values were statistically analyzed using the ANOVA test.

Piperine was designated as AChM3 receptor antagonist if there was a decrease of the pD2 value of histamine due to piperine. The data distribution of the pD2 values of histamine was analyzed using a normality test (Kolmogorov-Smirnov method). Subsequently, the shift in pD2 value was analyzed with parametric statistical methods (ANOVA test followed by LSD test at 95% confidence level).

Determination of antagonist type was performed using a Schild-plot analysis in the form of a regression analysis. The Y axis is the ratio of the EC50 of agonist in presence of antagonist to EC50 of agonist in absence of antagonist, and then minus one. The X-axis is the logarithm of the concentration of antagonist. The antagonist type is determined based on the value of the slope generated by the Schild-plot equation. If the slope value is close to one, the receptor antagonist is competitive, whereas if the value of the slope is not close to one, it is non-competitive. The pA2 value (antagonist affinity of piperine to the receptor) is the intercept value of the Schild-plot [7].

$$\log EC_{50} = \left[ \frac{50 - Y_1}{Y_2 - Y_1} X (X_2 - X_1) \right] + X_1 \quad (\text{equation. 1})$$

where:

X1 : log of concentration with response below 50%

X2 : log of concentration with response above 50%

Y1 : % response below 50%

Y2 : % response above 50%

$$pD2 = -\log EC50 \quad (\text{equation. 2})$$

### 2.4. *In Silico Study*

Docking process was done by using the Auto Grid 4.2 and 4.2 Autodock via Cygwin Terminal. File from previous preparation that includes Target.pdbqt, Ligand.pdbqt, parameter file (\*.gpf), and docking parameter file (\*.dpf) was stored in one folder on Cygwin Terminal. The results of docking was formatted by \*.dlg file format. This file contains 10 conformation information and complex.pdb file that used for results visualization. After that, Visualization of the results was done by using DS Visualizer application. DS Visualizer app will show the bonding form of a compound with a receptor in 3D.



### 3. Results and Discussion

Piperine is a compounds that are known could inhibit degranulation of the mast cell cultures through inhibition of phosphatidylinositol 4-kinase[7]. In addition, the study of herbal mixtures that contains extract of *Piper nigrum* L, shows the bronchodilation effect in the rats that induced by ovalbumin<sup>6</sup>. There is the possibility of piperine also have spasmolytic mechanism to inhibit the activation of the H<sub>1</sub> receptor. Therefore, this study was conducted to prove the piperine antagonist activity at the H<sub>1</sub> receptor.

The mechanism of ileum contraction by histamine H<sub>1</sub> receptor is mediated by G protein. Because of that, the receptor was categorized as G-protein-coupled Resetor (GPCR). The second messenger of the pathway was mediated by phospholipase C (PLC). Furthermore after PLC was activated, it will catalyze the hydrolysis reaction of fosfoinositol 4,5-diphosphate (PIP<sub>2</sub>) to form inositol 1,4,5-triphosphate (IP<sub>3</sub>) and diasil glycerol (DAG). IP<sub>3</sub> which has been formed binds to IP<sub>3</sub> receptor on the surface of the endoplasmic reticulum and open Trancient potential Receptor Channels (TRPC) and resulted in the release of Ca<sup>2+</sup> + from calcium-store. After that the level of intracellular Ca<sup>2+</sup> will increase. Increased levels of intracellular Ca<sup>2+</sup> can activate the calcium channels in the membrane cell surface [16].

Activation of calcium channels lead to an influx of extracellular Ca<sup>2+</sup> and overall would increase the levels of Ca<sup>2+</sup> instaseluler that induce smooth muscle contraction[17]. The increasement levels of intracellular Ca<sup>2+</sup> + that derived from GPCR activation or ion channels can cause contraction of the smooth muscle. Ca<sup>2+</sup> ion can bind toCa<sup>2+</sup> calmodulin receptor (CaM). Calmodulin binding protein is a Ca which does not have the enzyme activity. Calmodulin will work after forming complexes with Ca<sup>2+</sup> calmodulin. Furthermore, the complex activates myosin light-chain kinase (MLCK) which phosphorylate myosin. Phosphorylated myosin will interacts with actin filaments and produce contraction[18]. piperine can be said to have activity as an H<sub>1</sub> receptor antagonist if it can reduce the potential for histamine to induce smooth muscle contractions. An in vitro study aims to determine the activity of the piperine as H<sub>1</sub> receptor antagonist. In this study we used piperine with level 1 mM and 5 mM.

#### 3.1. Preliminary study the effect of DMSO on ileal smooth muscle contraction.

DMSO was used as piperine solvent in this study, so that DMSO need to be tested first its effect on smooth muscle contraction. DMSO are expected to has no effect on the contraction of illeum smooth muscle. DMSO was used with the volume 100μL. It was accordance to piperine administration to the organ bath.The test results shown a slight shift in the curve (Figure 1).

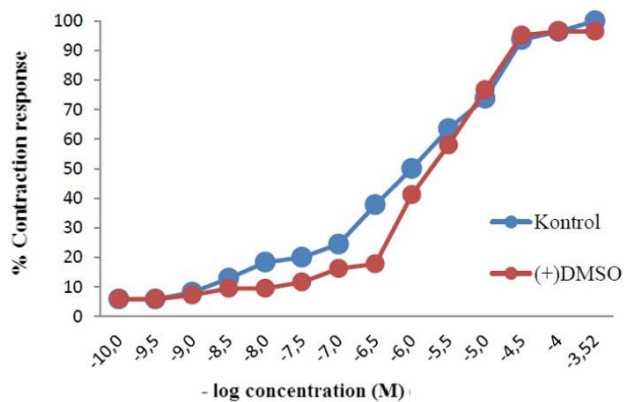

Fig. 1 Concentration-response curves to histamine in the absence or presence of DMSO at volume 1000 uL in guinea pig ileal smooth muscle (data represent n = 5-10, mean  $\pm$  SEM).

This effect was followed by a decrease in the value of PD<sub>2</sub> of DMSO (Table 1). However, based on statistical tests by using paired t-test, it was not significantly different ( $p > 0.005$ ). Therefore, DMSO does not have the effect of lowering the contraction significantly so that it can be used as a piperine solvent.

Table 1. Effect of DMSO on ileal smooth muscle contraction

Groups	PD <sub>2</sub>	E max
Control	5.84 $\pm$ 0.12	100 % $\pm$ 0.00
DMSO	5.72 $\pm$ 0.13	100 % $\pm$ 0.00

Effect of DMSO on the response of ileal smooth muscle contraction induced by histamine. The pD<sub>2</sub> and Emax values of histamine in absence and presence of 100 mL DMSO (n = 5, mean  $\pm$  SEM).

### 3.2. Comparative study using diphenhydramine

H<sub>1</sub> receptor distributed on the surface of the smooth muscle of guinea pig ileum. By histamine H<sub>1</sub> receptor activation will result in contraction of smooth muscles both in humans and guinea pig ileum. Diphenhydramine comparative study conducted by using the same method with treatment using piperine. Diphenhydramine is a first-generation H<sub>1</sub> receptor antagonist with has sedative and anti-allergic properties. Diphenhydramine competitively inhibit the H<sub>1</sub> receptor. Usually diphenhydramine used for the symptoms caused by endogenous histamine in the bronchi, blood vessels and gastrointestinal smooth muscle. The purpose of this comparison study is to see if there is a same effect between diphenhydramine and piperin as antihistamines. It is also to ensure the methods that used is valid to prove an H<sub>1</sub> receptor antagonist. Test results showed that diphenhydramine could shifts the contraction response curve to the right (Figure 2) and it cause the PD<sub>2</sub> impairment (Table 2).



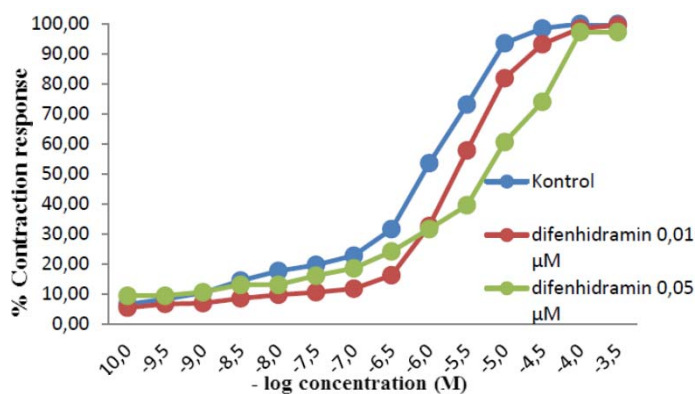

Fig. 2 Concentration-response curves to histamine in the absence or presence of diphenhydramine at concentrations of 1 & 5 μM in guinea pig ileal smooth muscle (data represent n = 5-10, mean ± SEM).

Shape of the curve shows contraction responses ( $E_{max}$ ) agonist back to 100% after being treated with histamine. The position of competitive antagonist which occupied the same active receptors can be shifted with the addition of the agonist concentration. So that the  $EC_{50}$  can be achieved with the addition of the higher agonist concentration. Maximal response ( $E_{max}$ ) can be returned 100%. It shows that diphenhydramine is a competitive antagonist to the  $H_1$  receptor.

Table 2. Effect of diphenhydramine on ileal smooth muscle contraction

Groups	PD <sub>2</sub>	E max
Histamine control	6.10 ± 0.16	100 % ± 0.00
Diphenhydramine 0.01 μM	5.67 ± 0.09	100 % ± 0.00
Diphenhydramine 0.05 μM	5.15 ± 0.23*	100 % ± 0.00

\* Significant difference ( $P < 0.05$ ) compared to control.

Effect of diphenhydramine on the response of ileal smooth muscle contraction induced by histamine. The pD<sub>2</sub> and Emax values of histamine in absence and presence of diphenhydramine (n = 5, mean ± SEM).

In addition, the type of antagonist can also be determined by Schild-plot analysis. From this Schild-plot analysis we obtained equation  $y = 0,7542x + 1.7281$ . Schild slope value equation-Plot is at 0.7542 (approaching 1.00) and intercept (PA<sub>2</sub> value) of 1.7281. PA<sub>2</sub> value (parameter affinity) showed levels of antagonists which may cause the levels agonist folded into 2 times to get the same effect as before given the antagonistic effect. From this assay it can be concluded that diphenhydramine acts as a competitive antagonist to the  $H_1$  receptor.

### 3.3. Antagonism effect of piperine to the $H_1$ receptor.

Antagonism effect of piperine to the  $H_1$  receptor was done by observe the changes in the curve of contraction profiles. Piperine thought to have potential as an  $H_1$  receptor antagonist. This potential can be measured by comparing the value of PD<sub>2</sub> histamine with and without piperine pretreatment. Pretreatment of ileal smooth muscle with piperine should be able to make value of PD<sub>2</sub> histamine lower. Histamine can induce contractions after binding with  $H_1$  receptors on smooth muscle of ileum. Increase in concentration of exogenous histamine also resulted in the increase in percentage contraction response. Response of isolated ileum smooth muscle contraction will achieve 100% on administration of exogenous histamine at the level  $3 \times 10^{-4}$  M. The results showed that ileal smooth muscle pretreatment with piperine 1mM and 5mM for 5 minutes, able to reduce the response of isolated ileum smooth muscle contraction

induced by exogenous histamine in a concentration-dependent pattern. Reduction of contraction response occurs primarily in low concentrations of histamine administration. The profile curves (Figure 3) shows the shift of declining curve of histamine concentration series. Curve Shifting shows a decrease in the ability of histamine to induce contraction due to the effect of pretreatment using 1mM and 5 mM piperine.

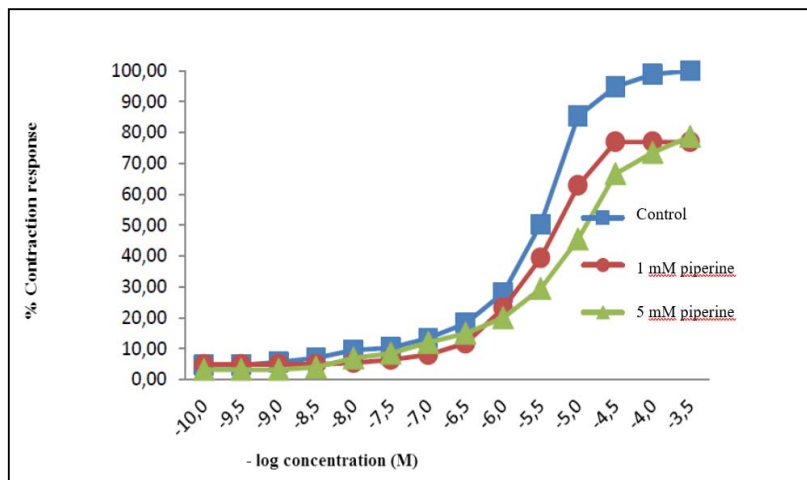

Fig. 3 Concentration-response curves to histamine in the absence or presence of piperine at concentrations of 1 & 5 mM in guinea pig ileal smooth muscle (data represent n = 5-10, mean  $\pm$  SEM).

This effect is also characterized by impairment  $PD_2$  histamine (Table 3). The  $PD_2$  value of histamine with piperine pretreatment 1 mM and 5 mM respectively amounted to 5.61, 5.24 and 4.94. This  $PD_2$  Impairment was statistically significant ( $p < 0.05$ ).  $PD_2$  histamine decline because of the influence of piperine pretreatment. piperine prove have antagonistic effects on the smooth muscle of ileum  $H_1$  receptor. To know the type of piperine antagonists, can be seen in the shape of contraction. Ileal smooth muscle can not restore the contraction response ( $E_{max}$ ) to 100%.

Table 3. Effect of iphenhydramine on ileal smooth muscle contraction

Groups	$PD_2$	$E_{max}$
Histamine control	5.61 $\pm$ 0.12	100 % $\pm$ 0.00
Piperine 1 mM	5.24 $\pm$ 0.16	76.93% $\pm$ 0.00
Piperine 5 mM	4.94 $\pm$ 0.52*	78.68 % $\pm$ 0.00

\* Significant difference ( $P < 0.05$ ) compared to control.

Effect of piperine on the response of ileal smooth muscle contraction induced by histamine. The  $pD_2$  and  $E_{max}$  values of histamine in absence and presence of piperine (n = 5, mean  $\pm$  SEM).

In the pretreatment of 1  $\mu$ M piperine,  $E_{max}$  reached 76.93%. And in the treatment with 5 mM,  $E_{max}$  reached 78.68%. Non-competitive antagonist is an antagonist that reduces the effectiveness of an agonist through a different mechanism (have different binding site). From this result we know that piperine categorized as non competitive antagonist on the  $H_1$  receptor.

The next assay is reversibility study. Reversibility test aims to determine whether the bond alkaloid pepper with  $H_1$  receptor can dissociate so that the effect of the contraction of ileal receptor can be returned. The assays were carried through by wash ileum of guinea pigs by replacing the buffer Tyrode every 5 minutes for 30 minutes. Antagonist binding properties of pepper alkaloid said reversible if the value of  $PD_2$  contraction after treatment is not much different from the before. The results can be

seen in the response curve (Figure 4). We can see the shape of the curve is relatively similar. In addition the value of  $PD_2$  (Table 4) are not much different and statistically there was no significant difference between the control and test groups ( $p > 0.005$ ). Based on this, we can conclude piperine bonding can be removed in washing every 5 minutes for 30 minutes. In other words, piperine bonding to H1 receptor was reversible.

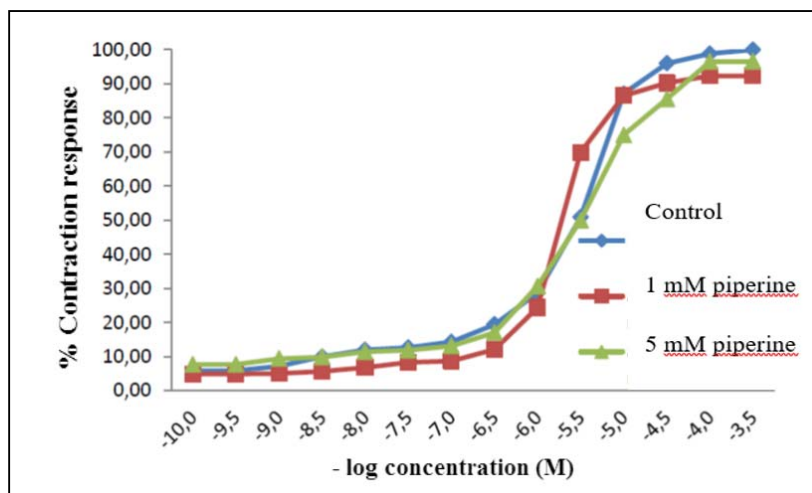

Fig. 4 Reversibility assay: Concentration-response curves to histamine in guinea-pig ileal smooth muscle after treatment with piperine (data represent  $n = 5-10$ , mean  $\pm$  SEM).

Table 4. Reversibility assay of piperin in the H<sub>1</sub> receptor

Groups	$PD_2$	E max
Histamine control	$5.61 \pm 0.16$	$100 \% \pm 0.00$
Piperine 1 mM	$5.73 \pm 0.09$	$92.35 \% \pm 0.00$
Piperine 5 mM	$4.54 \pm 0.23$	$96.52 \% \pm 0.00$

Reversibility Effect of piperine on the response of ileal smooth muscle contraction induced by histamine.  $PD_2$  and  $E_{max}$  values of metacholine ( $n = 5$ , mean  $\pm$  SEM).

### 3.4. In silico study of piperin to H<sub>1</sub> receptor.

Before starting the docking process, the first step that must to do is validation of docking protocol. Valid docking method can be indicated by the value of RMSD (Root Mean Square Distance). Valid RMSD value is usually below 2,0000. Native ligand that used in this validation stage is doxepin (5EH). RMSD value that obtained was 1.723 (2.0000) with a docking score is -5.6. From this result we can know that the docking protocol docking is valid.

Piperin activity to the H<sub>1</sub> receptor can be studied through in silico molecular docking method. Applications that used for in silico study was AutoDockTools. The protein used as the target is 3RZE which is an H<sub>1</sub> receptor protein in humans. Docking process produces 10 conformations that contains information energy of each conformation. Results of 10 conformations are seen on its binding energy to choose the best conformation for binding energy value describes the strength of bonds between ligand and protein. If there is more negative energy value of the bond, it indicate the stronger bonding to the receptor. Score of the bond and the interaction energy between each ligand to the target protein can be seen in Table 5.

Table 5. Binding energy score and interaction of ligand to the amino acid residue of H<sub>1</sub> receptor

Groups	Binding energy	Amino acid residue
--------	----------------	--------------------

	(kcal/mol)	
Piperine	-5.70	Isoleucine 438
		Histidine 450
		Isoleucine 454
		Lysine 179
Doxepine (5EH)	-5.02	Aspartic acid 107
		Histidine 1031
		Leucine 1032
		Phenylalanine 1104
Diphenhydramine	-6.99	Tyrosine 458
		Tryptophan 428
		Tyrosine 431
		Serine 111
		Tyrosine 108
		Phenylalanine 432

Piperine score is slightly higher than the original 5EH as ligands and lower than diphenhydramine as an H<sub>1</sub> receptor antagonist. But in vitro study piperine alkaloid known act as non-competitive antagonist.

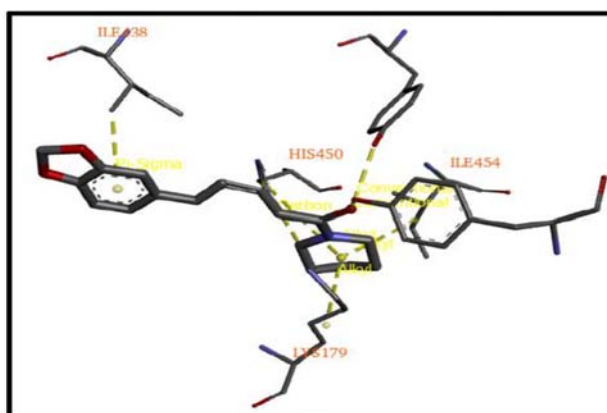

Fig. 5 Docking visualization of piperine on H<sub>1</sub> receptors.

H<sub>1</sub> receptor has many amino acids, but only partially that important in histaminergic activity, that is Trp428, Asp107, Asn198, Lys191, and Lys179. Furthermore Asp107 and Trp428 amino acid is an amino acid that plays an important role in bonding histamine as antagonist [20,21]. In this study, it can be seen conformation 5HE (original ligand) with the highest bond energy value (-5.02) binds to the residue Asp107, while piperine conformation with the highest bond energy value (-5.70) binding to Lys179. Diphenhydramine as a competitive antagonist with an energy value of bonds the highest (-6.99) binds the amino acid Trp428. From the in silico results it can be concluded that diphenhydramine ligand binds to both amino acids Asp107 and Trp428 was the important bonding, in accordance with the histamine antagonist diphenhydramine function that works as a competitive antagonist to the H<sub>1</sub> receptor. While piperine in vitro assays pepper alkaloid previously shown to be a non-competitive antagonist that binds to the protein side Lys179 are also important in the histaminergic system.

## Conclusion

Piperine have antagonism activity on H<sub>1</sub> receptor, by PD<sub>2</sub> impairment. From Schild plot analysis the type antagonism is non-competitive antagonist. From the in

silico study, piperine can bind to the H<sub>1</sub> receptor (docking Score: -5.70). Piperine can bind to Lys179 residue of H<sub>1</sub> receptor, which is one important residue in histaminergic activity.

## Acknowledgements

We would like to thank LP3M UMY Research Grant 2014 and the Faculty of medical and health science universitas muhammadiyah yogyakarta.

## References

- [1] Madhavi, B. B.(2009). Extraction, identification, formulation and evaluation of alkaloid ladae in alginate beads, *International Journal of Pharmacy and Pharmaceutical Sciences*, 1(2), 156-161.
- [2] Pei, Y. Q. (1983), A review of pharmacology and clinical use of alkaloid ladae and its derivatives, *Epilepsia*, 24(2), 177-182.
- [3] Epstein, W. W., Netz, D. F., & Seidel, J. L., (1993), Isolation of alkaloid ladae from black pepper, *Journal of Chemical Education*, 70, 598
- [4] Mujumdar, A. M., Dhuley, J. N., Deshmukh, V. K., Raman, P. H., & Naik, S. R., (1990), Anti-inflammatory activity of alkaloid ladae, *Japanese Journal of Medical Science and Biology*, 43(3), 95-100.
- [5] Bang, J. S., Choi, H. M., Sur, B. J., Lim, S. J., Kim, J. Y., Yang, H. I., & Kim, K. S., (2009), Anti-inflammatory and antiarthritic effects of alkaloid ladae in human interleukin 1 $\beta$ -stimulated fibroblast-like synoviocytes and in rat arthritis models, *Arthritis research & therapy*, 11(2), R49.
- [6] Antony, A. S., JayaSankar, K., Roy, P. D., Vadivelan, R., Satish Kumar, M. N., & Elango, K., (2010), Pharmacological and biomolecular investigations of a polyherbal formulation (AAF-6) for its antiasthmatic activity, *International Journal of Green Pharmacy*, 4(4), 257.
- [7] Bojjireddy, N., Sinha, R. K., & Subrahmanyam, G., (2014), Alkaloid ladae inhibits type II phosphatidylinositol 4-kinases: a key component in phosphoinositides turnover, *Molecular and cellular biochemistry*, 393(1-2), 9.
- [8] Huang, J., Zhang, T., Han, S., Cao, J., Chen, Q., & Wang, S., (2014), The inhibitory effect of alkaloid ladae from *Fructus piperis* extract on the degranulation of RBL-2H3 cells, *Fitoterapia*, 99, 218-226.
- [9] Gandjar, I.G., & Abdul Rohman, (2007), *Kimia Farmasi Analisis, Pustaka Pelajar*, Yogyakarta.
- [10] Marlina, Soerya Dewi, Venty, S., Suyono, (2005), *Skrining Fitokimia dan Analisis Kromatografi Lapis Tipis Komponen Kimia Buah Labu Siam (Sechium edule Jacq. Swartz.) dalam Ekstrak Etanol*, *Biofarmasi* 3 (1): 26-31, Februari 2005, ISSN: 1693-2242.
- [11] Silverstein, M. Robert, Webster, X. Francis, Kiemle, J. David, (2005), *Spectrometric Identification of Organic Compounds* 7th Ed, State University of New York : College of Environmental Science & Forest.
- [12] Pavia, D. L. (2000), *Introduction to Organic Laboratory Techniques, Tthird Edition*, United state : Brooks Cole/Thomson (Page: 91-93)
- [13] Vishvnath, G., & Jain, U. K., (2011), Quantitative analysis of piperine in ayurvedic formulation by UV Spectrophotometry, *Int J Pharm Sci Res (IJPSR)*, 2, 58-61.
- [14] Adosraku, R K, James, O K, Isaac, Y A, (2013), Characterization And HPLC Quantification Of Piperine Isolated From *Piper Guineense* (Fam. Piperaceae), *International Journal of Pharmacy and Pharmaceutical Sciences*, Vol 5, Issue 1, 2013 ISSN- 0975-1491.
- [15] Hart, H., Craine, L. E., & Hart, D. J., (1999), *Organic chemistry: A short course*, Boston: Houghton Mifflin Co.
- [16] Sanders, K.M., (2001), Invited Review: Mechanisms of Calcium Handling in Smooth muscles, *J.Appl.Physiol*91: 1438-1449
- [17] Gosens, R., Zaagsma, J, Meurs, H. and Halayko, A.J., (2006), Muscarinic Receptor Signaling in the Pathophysiology of Asthma and COPD, *Respir.Res.*7(1) : 73-8
- [18] Lodish, H., Berk, A., Zipursky, A.L, Matsudaira, P., Baltimore, D., Darnell, J., (2000), *Molecular Cel Biology*, 4th ed, Freeman and Company, New York.

- [19] Nugroho, A. E., Agistia, D. D., Tegar, M., & Purnomo, H., (2012), Interaction of active compounds from *Aegle marmelos* CORREA with histamine-1 receptor, *Bioinformation*, 9(8), 383-387.
- [20] Shimamura, T., Shiroishi, M., Weyand, S., Tsujimoto, H., Winter, G., Katritch, V., & Kobayashi, T., (2011), Structure of the human histamine H1 receptor complex with doxepin, *Nature*, 475(7354), 65-70.
- [21] Rahim, F., (2010), An in silico development of selective inhibitor for histamine receptors, *Biotechnology*, 9(2), 157-16.



---

**THE EFFECT OF EXTRACT YELLOW PUMPKINS SEED (*CUCURBITA  
MOSCHATA*) ON HISTOLOGY OF ENDOMETRIAL GLANDS IN  
OVARIECTOMIZED RATS**

Alfaina Wahyuni<sup>a</sup>, Abi Nubli<sup>a</sup>, Sri Tasminatun<sup>b\*</sup>

<sup>a</sup>Department of Obstetrics and Gynecology, Medical Science Study Program Faculty of  
Medicine & Health Science, Universitas Muhammadiyah Yogyakarta; Jalan Lingkar Selatan  
Tamantirto Kasihan Bantul DIY, Indonesia 55183

<sup>b</sup>Pharmacy Study Program, Faculty of Medicine & Health Science, Universitas  
Muhammadiyah Yogyakarta; Jalan Lingkar Selatan Tamantirto Kasihan Bantul DIY,  
Indonesia 55183

---

**Abstract**

Menopausal symptoms turn out to be a health problem threatening the quality of women's life. These symptoms are triggered by the decrease of estrogen produced by ovaries. Treatment using phytoestrogens could be expected to reduce the symptoms. Pumpkin seeds (*Cucurbita moschata*) contain secondary metabolites isoflavones that have a structure similar to endogenous estrogen and it can occupy estrogen receptor. The purpose of this study was to analyze the effects of *C. moschata* seeds in ovariectomized rats on the histology of endometrial glands. An experimental study in vivo with only post-test with control group design was conducted using 30 female Sprague-Dawley rats, 8 weeks old, weight 148-280 g. The rats were divided into 6 groups: control group (Normal), only ovariectomized group (OVX), ovariectomized rats given the extract of *C. moschata* 100, CM 200 and CM 400 mg / kg body weight for 30 days (OVX-CM100; OVX-CM200; OVX-CM400), and ovariectomized rats given estradiol 2 µg/kg as a positive control (OVX-E). Rats were sacrificed on day 31. Uterine was removed and an analysis on the number of endometrial glands, diameter of lumen's glands and the thickness of the endometrial glandular epithelium was carried out. Statistical analysis was using One Way ANOVA. The conclusion is *Cucurbita moschata* extract was significantly increase the number of glands and diameter of lumen's endometrial glands (p<0,05).

Keywords: menopause, *Cucurbita moschata*, histology of the endometrium, endometrial glands.

## 1. Introduction

Menopause usually occurs around age 45 to 55 years at 60-70% of women. The average age in the western population is around the age of 50 years. Women in developing countries usually reach menopause earlier compared to women in Western populations. Menopause is a condition of the ovary failure to produce estrogen. 50-80% of women experience symptoms of menopause, include hot flashes, night sweat, vaginal dryness, insomnia, mood swings and depression. The increasing number of women, especially of elder age, presents a new problem. Symptoms of menopause incite discomfort and decrease the quality of the woman's lives (Savitri et al., 2009)

Hormone Replacement Therapy (HRT) is commonly given to women suffering from to overcome the symptoms of post-menopause. Unfortunately, women exposed to long-term use of HRT are also exposed to its identified malicious side effect, the increasing risk of ovarian and endometrial malignancies (Manson & Martin, 2001). It is advised for menopausal women to wisely resorting to an existing alternative treatment, phytoestrogen therapy, as it is proven to be safer [Rimoldi et al., 2007]. Phytoestrogens are substances of plant origin that are structurally and functionally similar to the estrogens. Phytoestrogens are proposed to replace the function of estradiol as body's natural estrogen. Phytoestrogens are also promoted as being an estrogen agonist, because they can occupy estrogen receptors (Savitri et al, 2009). There are four main types of groups of phytoestrogen in plants such as flavonoids, coumestan, lignans, and stilbene. Isoflavonoids are one class of phytoestrogens. Isoflavonoids are divided into three groups: isoflavones, isoflavan, and coumestan (Whitten & Pattisaul, 2001 *cit.* Sitasiwi, 2009).

Pumpkin (*Cucurbita moschata*), is a fruit with a completely nutritional content. Types of pumpkins that grew in Indonesia are varieties of *C. moschata* and *C. pepo* (Sushanty, 2013). In Indonesia, pumpkins have been used to produce many kind of traditional food, but the pumpkin seeds are not widely used. According to Li et al. (2009), phenolic glycoside compounds found in the seeds of *C. moschata* are phenylcarbinyl 5-O-(4-hydroxy) benzoyl-beta-D-apiofuranosyl (1-->2)-beta-D-glucopyranoside. Glycosides of phenolic compounds in the seeds of *C. moschata* are one of isoflavone derivates (Koike et al.,2005). Phillips et al. (2005) mention that the pumpkin seeds contain phytoestrogen 265 mg in 100 grams of seeds. Pumpkin seeds also contain secoisolariciresinol which is a lignin compound (Sicilia et al., 2003). Lignan is one of the main classes of phytoestrogens agent (Cornwell et al., 2004). This background information above leads the researchers to hypothesize that pumpkin seed extract (*C. moschata*) has the estrogenic effect on reproductive organs, especially on endometrial glands.

## 2. Material and Methods

### 2.1 Plant and Chemical Materials

Seeds of pumpkin (*C. moschata*) used in the present study were collected from the commercial market in Kulonprogo Yogyakarta and authenticated at the Laboratory of Plant Taxonomy, the Faculty of Biology, GadjahMada University, Yogyakarta, Indonesia. Concentrated nitric acid solution, perchlorate acid solution, distilled water and calcium carbonate were obtained from LPPT GadjahMada University, Yogyakarta, Indonesia

### 2.2 The Preparation of Ethanolic Extract of Pumpkin Seeds (*C. moschata*)

The dried powders of seeds of pumpkin (*C. moschata*) were extracted by maceration using 70% ethanol. The ethanolic extracts were evaporated to obtain the concentrated extract.

### 2.3. Animals

Female Sprague–Dawley rats, aged 8 week, were purchased from Faculty of Medicine, Gadjah Mada University, Yogyakarta, Indonesia. The animals were grouped and maintained under standard laboratory conditions with dark and light cycle (12/12 h) and allowed free access to commercial pellet diet and water ad libitum.

### 2.4. Administration Procedure

Rats were acclimatized to laboratory condition for 1 week before the commencement of the experiment. The ovariectomy was performed to all experimental rats except to those belonging to the normal group. Animals were assigned to the experimental groups, normal, OVX, OVX-E, OVX-ECM100 mg/kg BW, OVX-ECM 200 mg/kg BW, OVX-ECM400 mg/kg BW, with five animals per group, per experiment. Twenty days after the rats were ovariectomized, all of the rats were allowed to the controlled access to a commercial standard pellet and to deionized water ad libitum for 20 days. The extract of *C. moschata* tuber was given orally once a day during 30 days and the doses were 100 mg/kg BW, 200 mg/kg BW, and 400 mg/kg BW to the experimental group of OVX-ECM. The group of OVX-E was given estradiol with the dose of 2 µg/day, and the control groups and OVX did not get any treatment. On the 31st day, the rats were sacrificed and their uterine were taken to histological analysis.

### 2.5. Uterine Histological Analysis

The uterine horns were immediately removed and fixed in 4% para-formaldehyde (PFD) at 4oC for 4 to 5 hours. The tissues were then processed through different grades of ethanol, incubated overnight in chloroform, transferred into paraffin wax for 3 hours, placed into the molds prefilled with melted wax, and cooled immediately at -60 o C to harden the wax. Tissues were then cut into 5 µm sections and mounted onto glass slides. The slides were then stained with hematoxylin and eosin (H&E), visualized under a light microscope under magnifications of 4, 20 and 40 times. The diameter, the epithelial height and number of uterine glandular lumen were measured.

## 3. Results and Discussion

**Table 1.** The average of number, diameter of lumen glands and epithelial height of endometrial glands. Analyses of morphology of the endometrial glands in the uterine section following treatment with different doses of extract of *C. moschata* seeds (ECM): Normal, OVX (ovariectomized), OVX-E (ovariectomized + estradiol), OVX-ECM : ovariectomized + extract of *C. Moschata* seeds 100 (100 mg/kg/day), 200 (200 mg/kg/day), 400 (400 mg/kg/day). Values represent mean ± SEM with n=5 per group. The average number of glands per cross section increased with increasing doses of genistein treatment. \* (p<0.05 as compared to control Normal), † (p<0.05 as compared to control positive OVX-E).

The group of treatment	Diameter of lumen's glands (mean ± SEM)	Epithelial height of endometrial glands (mean ± SEM)	Number of endometrial glands (mean ± SEM)
1. Normal	43,27 ± 7,40	13,90± 1,58	4,70± 2,21 †
2. OVX	28,82 ± 8,05 *	11,45± 3,36	1,35± 1,36 *†
3. OVX-E	46,27 ± 11,98	14,03± 0,67	13,04± 4,51*
4. OVX-ECM 100	41,66 ± 5,85	14,42± 1,91	6,2± 1,20 *†
5. OVX-ECM 200	46,06 ± 1,84	14,85± 1,49	5,65± 1,73 *†
6. OVX-ECM 400	46,27 ± 11,98	14,77± 1,71	9,75± 2,28 *

In table 1, the lowest number of the endometrial glands is the negative control group (OVX), while the highest number is the positive control group (OVX-E). The number the endometrial glands increased following treatment with extract *C. moschata*. A dose-dependent increase in the number of endometrial gland was observed with increasing doses of orally extract *C. moschata* treatment. Treatment with 400 mg kg/day *C. moschata* resulted in significant increase in the number of gland compared with normal control but not significantly to the positive control group (OVX-E).

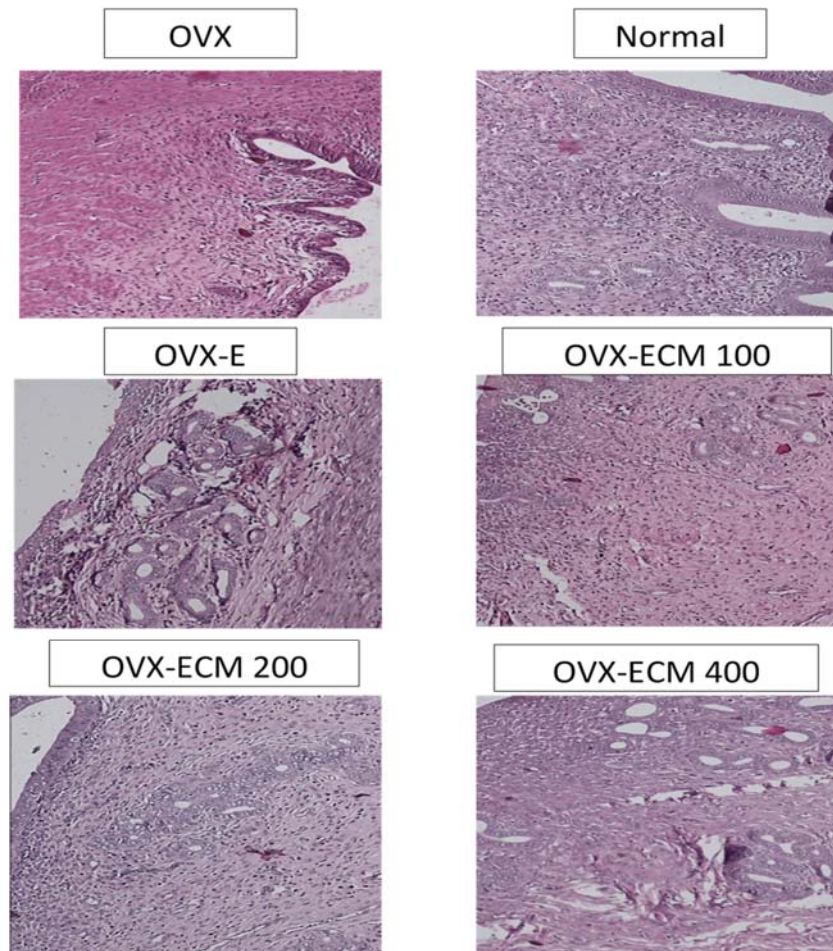

**Figure 1.** The morphology of endometrial glands among the groups. a. OVX ( only ovariectomized); b. Normal (without ovariectomized and no treatment); c. OVX-E (ovariectomized + estradiol); d. OVX-ECM 100 (ovariectomized + ECM 100); OVX-ECM 200 (ovariectomized + ECM 200) and e. OVX-ECM 400 (ovariectomized + ECM 400). Sections were stained with H&E, magnification 40x.

Table 1 shows that the smallest gland lumen diameters belong to the negative control (OVX), while the values of the sizes of diameter among the normal control group, positive control, and treatment groups is significant differences. One Way ANOVA statistical test showed that there are significant differences in the number of endometrial glands among the six treatment groups ( $p < 0.05$ ). Post hoc Tukey HSD test performed afterwards showed that the result from the negative control group (OVX) was significantly different with other groups. Observation on endometrial glandular epithelial shows thickness are low in the negative control group (OVX) and the highest in the positive control group (OVX-E). In the experimental group, ECM increased endometrial glandular epithelial thickness, and this increase is in line with the increasing dosage, but statistically there are no significant differences among all groups.

This research was performed to know the estrogenic activity of the pumpkin seed extract orally. To induce conditions similar to those of menopause, rats were ovariectomized and spared for 30 days. The observed parameters are the histology of endometrial glands, including the number, diameter and thickness of the endometrial glandular epithelium.

*C. moschata* seeds contain secoisolariciresinol, which belongs to the compound of lignans (Sicilia et al., 2003), and phenolic glycosides that are included in isoflavones (Lie et al., 2009). Lignans and isoflavones are primary classes of a phytoestrogen agent (Cornwell et al., 2004). There are four main types of phytoestrogens, namely flavonoids, coumestan, lignans and stilbene (Whitten & Pattisaul, 2001 *cit.* Sitasiwi, 2009). The phytoestrogens are supposedly working as an estrogen agonist by engaging with estrogen in a competition to occupy the estrogen receptors (Savitri et al., 2009). When estrogen levels are down, there will be an excess of estrogen receptors that does not bind to estrogen. Isoflavones, although having low affinity, can still bind the receptor (Cahyati et al., 2013).

The estrogen receptors (ER) have multiple functional domains. There are two types of ER, namely ER $\alpha$  and ER $\beta$ . The differences are in the C-terminal ligand-binding domain and the N-terminal transactivation domain. The estrogen receptor  $\alpha$  (ER $\alpha$ ) is abundant in cells in the reproductive organs such as the endometrium, breast cancer cell line, and ovarian stroma, whereas the estrogen receptor  $\beta$  (ER $\beta$ ) is widely distributed in cells besides reproductive organs including the kidney, mucosal intestinal, lung parenchyma, bone, brain, endothelial cells, and prostate gland. Thus, the bonding estrogen-ER is an important process to causing estrogenic effects (Kuiper et al., 1998; Weirman, 2007).

The estrogenic effects generated by the phytoestrogens are  $10^2$  to  $10^3$  times lower than the estrogenic effects of 17 $\beta$ -estradiol, which are the endogenous estrogen in the body (Benassayag et al., 2002). This is due to the affinity of phytoestrogens to the estrogen receptor which is lower than that of estrogen (Cederroth et al., 2007). The phytoestrogens are able to bind to estrogen receptors (ER $\alpha$  and ER $\beta$ ) and functioning as the estrogen receptor antagonists or agonists (Benassayag et al., 2002).

The results of this study showed that administration of extract *C. moschata* significantly increases the number of glands and the diameter of the lumen of endometrial glands, whereas the epithelium thickness of the endometrial glands shows no significant increase. A dose-dependent increase in the number of glands was observed with increasing doses of extract of *C. moschata* given orally. In the negative control group that only performed ovariectomy, all three parameters are the lowest. The ovariectomy performed on the rats has successfully exhibit the symptoms of menopause on those rats.

The increasing number of endometrial glands is supposedly due to the proliferation and differentiation of endometrial glands through a mechanism described by Cooke, et al (1998). This mechanism commences when phytoestrogens bind to hormone receptors on the target cell, and accordingly they can transform the conformation of the hormone receptors. This leads to conformational change in which the phytoestrogens-receptor complexes become activated so they can bind with the DNA chain. Interaction between the phytoestrogens-receptor complexes with DNA causing gene expression is increased.

The endometrial glands are simple tubular glands. These glands change throughout the estrous cycle. The glands undergo repeated branching. On the observation the number of the gland transverse incision in increasing numbers. Gland development

occurs because of estrogen going to cause proliferation, morphogenesis, and differentiation. Estrogen plays a role in cell proliferation, especially in the transition of cells from phase G to phase S and affects gene regulation of growth (Cooke et al., 1998).

The increasing diameter of the endometrial glands after *C.moschata* extract is given during this research indicates the occurrence of gland development. Also such an occurrence is presumably related to with increasing secretion of fluid into the lumen of the gland as described in previous studies. Salleh et al (2013) already examined the effect of genistein on the endometrial glands and they concluded the endometrial glands increase in lumen diameter were in line with the increase of the amount of fluid in the lumen of the gland. Increasing fluid in the gland lumen is suspected to give a compression effect on endometrial epithelial cells so that the gland epithelium endometrial thickness remains unchanged.

#### **4. Conclusion**

The conclusion of this study is *C. moschata* seed extract treatment registered orally significantly increases the number of the endometrial glands and increases the diameter of the lumen of endometrial glands, but this treatment still provides no evidence of thickening the endometrial glandular epithelium in ovariectomized rats. Further research about the effects of *C. moschata* on other organs is still required to conclude that the extracts of *C. moschata* have estrogenic effects.

#### **Acknowledgements**

A sincere appreciation to the Research Grant of Directorate General of Higher Education Ministry of Research, Technology and Higher Education Republic of Indonesia which have funded this research.

#### **References**

- Benassayag C, Perrot-Apland M, Ferre F., (2002). Phytoestrogen As Modulator Steroid Action in target cells. *Journal of chromatography B, Analytical Technologies in The Bimedical and Life Sciences*, 777(1-2):233-248
- Cahyati, Y., Santoso, D. R., & Juswono, U. P., (2013). Efek Radiasi pada Penurunan Estrogen yang Disertai Konsumsi Isoflavon untuk Mencegah Menopause Dini pada Terapi Radiasi. *NATURAL B*, 114.
- Cederroth, C.R., Pitetti, J.L., Papaoannou, M.D. and Nef, S., (2007). Genetic programs that regulate testicular and ovarian development. *Mol. Cell. Endocrinol.*, 265-266, 3-9
- Cornwell T1, Cohick W, Raskin I., (2004). Dietary phytoestrogens and health. *Phytochemistry* Apr; 65(8):995-1016.
- Koike, K., Li, W., Liu, L., Hata, E., & Nikaido, T., (2005). New phenolic glucosides from the seeds of *Cucurbita moschata*. *PubMed*.
- Kuiper GG1, Lemmen JG, Carlsson B, Corton JC, Safe SH, van der Saag PT, van der Burg B, Gustafsson. (1998). Interaction of estrogenic chemicals and phytoestrogens with estrogen receptor beta. *JA. Endocrinology*. Oct; 139(10):4252-63.

- Li, F., Xu, J., Dou, D., Chi, X., Kang, T., & Kuang, H. , (2009). Structure of new phenolic glycoside from the seeds of *Cucurbita moschata*. PubMed .
- Manson, J. E., & Martin, K.,(2001). Postmenopausal Hormone-Replacement Therapy. *The New England Journal of Medicine* :35.
- P.S. Cooke, D.L. Buchanan, D.B. Lubahn, G.R. Cunha, (1998). *Biology of Reproduction* 59(1) : 470-475.
- Phillips K.M., David M. Ruggio and Mehdi Ashraf-Khorassani . (2005). Phytosterol Composition of Nuts and Seeds Commonly Consumed in the United States *J. Agric. Food Chem.*, 53 (24), pp 9436–9445
- Rimoldi G, Christoffel J, Seidlova-Wuttke D, Jarry H, and Wolfgang Wuttke W. (2007). Effects of Chronic Genistein Treatment in Mammary Gland, Uterus, and Vagina. *Environ Health Perspect.* 2007 Dec; 115(Suppl 1): 62–68.
- Salleh ,N., Mokhtar Helmy,M., Fadila kasim and Soh Onn Yeong, (2013)., Isoflavone Genistein Induces Fluid Secretion and Morphological Changes in the Uteri Post-Pubertal Rats. *Int. J. Med. Sci* ,vol 10: 665-675.
- Sawitri, E. I., Fauzi, N., & Widyani, R.,(2009). Kulit dan Mneopause dan Penatalaksanaan:55.
- Sicilia T, Niemeyer HB, Honig DM, Metzler M., (2003). Identifition and stereochemical characterization of lignans in flaxseed and pumpkin seeds. *J Agric Food Chem* 51: 1181–1188
- Sitasiwi, A. J., (2009). Efek Paparan Tepung Kedelai dan Tepung Tempe sebagai Sumber Fitoestrogen terhadap Jumlah Kelenjar Endometrium Uterus Mencit (*Mus musculus L.*).
- Weirman ME, (2007). Sex Steroid Effects at Target Tissue: Mechanism of Action. *Ad Physiol Educ* 31:26-33

---

**HALOPERIDOL COMBINATION THERAPY MORE COST-EFFECTIVE THAN RISPERIDONE COMBINATION THERAPY IN THE ACUTE PHASE THERAPY OF SCHIZOPHRENIA BASED ON POSITIVE AND NEGATIVE SYNDROME SCALE – COMPONENT (PANSS-EC)**

**Imaniar Ranti<sup>1</sup>, Andi Fauziyar Octaviany<sup>2</sup>, Sekar Kinanti<sup>2</sup>**

<sup>1</sup>Departement of Pharmacology, Faculty of Medicine and Health Science, Universitas Muhammadiyah Yogyakarta, Yogyakarta, Indonesia

<sup>2</sup>Undergraduate programme of Medical Science, Faculty of Medicine and Health Science, Universitas Muhammadiyah Yogyakarta, Yogyakarta, Indonesia

---

**Abstract**

Schizophrenia symptoms consist of positive symptoms and negative symptoms. Schizophrenia consists of three phases, that are acute phase, the stabilization phase and stable phase. Therapeutic target based on the phase and severity of illness. PANSS-EC test (Positive and Negative Syndrome Scale-Excited Component) is an instrument that can be used to evaluate the therapeutic efficacy. Pharmacologic therapy is used in the form of antipsychotic drugs which divided into two groups, typical antipsychotics (ex: haloperidol) and atypical antipsychotics (ex. Risperidone). The aim of this study was to investigate the effectiveness and cost- effectiveness of between haloperidol and risperidone on the acute phase of schizophrenia based on PANSS-EC value.

The study was observational method, pretest-posttest design, non-randomised, prospective, and open-label. The total sample is 40 schizophrenia patients in intensive care hospitalization. The effectiveness therapy was done by PANSS-EC. Cost-effectiveness analysis was done using cost-effectiveness diagram.

From Mann-Whitney test showed that there was no difference of effectiveness when using haloperidol combination or risperidone combination in the acute phase of schizophrenia patients based on PANSS – EC, but the results of cost-effectiveness analysis showed haloperidol combination therapy better than risperidone combination therapy on the acute phase of schizophrenia patients.

**Keywords**

Schizophrenia; Haloperidol combination therapy; Risperidone combination therapy; PANSS-EC; Cost-effectiveness

---

\* Corresponding author. Tel.: +62-815-4217-1122; fax: +62-0274-387646.  
E-mail address: imaniarranti@umy.ac.id



## 1. Introduction

One of mental health disorders are still relatively high in Indonesia is Schizophrenia. The incidence of schizophrenia in Indonesia estimated three to five per 1000 population (Hawari, 2007), it means about 1 million Indonesian people with schizophrenia (Arif, 2006). Schizophrenia is a severe mental disorder characterized by a distinctive and fundamental distortions in thinking and perception that is accompanied by the blunt affect or unnatural (Tandon et al., 2013). Schizophrenia symptoms are positive symptoms, negative symptoms, disorganized, decreased cognitive function and mood disorders. Based on American Psychiatric Association (APA), schizophrenia disease consists of three phases, there are acute phase, stabilization phase and stable phase (Reverger, 2012), so the goal of therapy will vary depending on the phase and severity of illness (Melatiani et al, 2013).

Pharmacological treatment of schizophrenia were divided into two groups: Typical antipsychotic (first generation) such as Haloperidol, Chlorpromazine, amitriptyline, etc; and Atypical antipsychotic (second generation) such as risperidone, clozapine, olanzapine, and etc (Michal&Iva, 2015). The types of drugs most commonly used to is the typical antipsychotic haloperidol (Reverger, 2012) and single therapy that often used in Indonesia is risperidone from atypical antipsychotic (Jarut et al, 2013). Research on the effectiveness of schizophrenia treatment is still being developed because there are no therapies that are truly effective until today. Selection of appropriate therapy in the acute phase of schizophrenia is very important, because it can determine the prognosis of the course of schizophrenia. PANSS-EC (Positive and Negative Syndrome Scale-Excited Component) is a simple and intuitif tool that can evaluate of positive symptoms and negative symptom in acute phase of schizophrenia.

Schizophrenia treatment costs will give negative impact for patients and their families. The overall cost of schizophrenia in the US (2002) is estimated to be \$ 62.7 billion, with \$ 22.7 billion excess direct health care costs (\$ 7.0 billion outpatient, \$ 5.0 billion drug, \$ 2.8 billion hospitalization cost, \$ 8.0 billion long-term care ) (Wu et al, 2005). Sinaga (2007) mentions that the economic burden to be borne by persons with schizophrenia and their families turned out to be quite large, because 50% of persons with schizophrenia are unable to work, the cost of treatment and care must be take for a long-term, as well as the time consumed for family members caring for persons with schizophrenia were affecting the economic burden of the family.

The treatment of schizophrenia requires monitoring of the effectiveness, safety of treatment, and cost-effectiveness because it need long term therapy. The aim of this study was to investigate the effectiveness and cost- effectiveness of between haloperidol combination therapy and risperidone combination therapy in the acute phase of schizophrenia based on PANSS-EC score. We hope the results of this study will contribute to the government's policy decisions in the selection of appropriate procedures, effective, and efficient for schizophrenia treatment.

## 2. Material and Methods

The study was observational method, pretest-posttest design, non-randomised, prospective, and open-label. The total sample is 40 schizophrenia patients in intensive care hospitalization, Grhasia Psychiatric Hospital of Yogyakarta. This study inclusion criteria was all patients diagnosed with schizophrenia with psychotic symptoms in the acute phas. The exclusion criteria was schizophrenic patients with congenital physical defects, impaired verbal function, and organic mental disorders.

The effectiveness therapy was done by PANSS-EC (Positive and Negative Syndrome Scale-Excited Component). PANSS-EC is an instrument used to assess the improvement in the state of schizophrenic patients in the acute phase. PANSS-EC consists of five main items, excitement, tension, hostility, uncooperativeness, and poor impulse control. The 5 items from the PANSS-EC are rated from 1 (not present) to 7 (extremely severe); scores range from 5 to 35; mean scores  $\geq 20$  clinically correspond to severe agitation (Lindenmayer et al, 2008). Schizophrenia patients the acute phase will be moved into the stable phase if the PANSS-EC score  $\leq 15$ . PANSS-EC assessment has been done at the beginning (pre-test) and end of treatment(post-test).

Cost-effectiveness analysis was done using cost-effectiveness diagram. Cost-effectiveness diagram can determine whether or not to do AEB. Before doing AEB, some calculation phase to be done, there are:

- Identify the level of drugs effectiveness from the literature
- Identify and count the cost of treatment. This study has calculated the direct costs by schizophrenia patients.
- Establish the position of alternative medicine in Table Cost Effectiveness. It is only cost of treatment, not cost ratio.

Pharmacotherapy has been given in this study was haloperidol and risperidol combined with chlorpromazine and trihexyphenidyl. Analysis of the results used the statistical test univariate analysis followed by bivariate analysis Mann-Whitney for the spread of abnormal data.

### 3. Result and Discussion

#### 3.1 Subjects Characteristics

Our findings showed that the age of this research subjects were the age group 20-39 years (20%), 30-39 years (42.5%), 40-49 years (27.5%), and the least is the age group >50 year (10.0%). These results are consistent with the results of research conducted by Fahlian Vishnu (2011) which states that the prevalence of schizophrenia patients aged greater incidence in young adults compared with old age. This is because the age of 30-39 years are productive age who tend to get into trouble-complex problems, including problems with close friends, co-workers, work too hard, economic, and family problems.

The research subject has been divided into 2 groups, there are Haloperidol combination therapy and Risperidone combination therapy. Measurement of pre-test PANSS-EC scores show that there was no significant difference in the two treatment groups ( $p = 0.155$ ) (Table 1). It means that both groups have equal treatment at the time of initial therapy before treatment with the Haloperidol combination or Risperidone combination.

Table 1. Analysis of Pre-test PANSS-EC Scores between Haloperidol Combination Therapy with Risperidone Combination Therapy

	Drugs	n	Mean PANSS-EC Score	Sig. (2-tailed)
<i>Pre-test</i>	Risperidon group	20	18.18	0.155
	Haloperidol group	20	22.83	
	Total	40		

The results of this study have been shown that patients with acute phase occurred in the first 7 days, between 1 days until 3 days (Table 2). This is consistent with the American Psychiatric Association (APA), which states schizophrenia disease course consists of three phases: the acute phase, the stabilization phase and stable phase

(Reverger, 2012). In the acute phase, a therapeutic target is reduce or eliminate the psychotic symptoms and improve the functioning of the patient's normal that usually occurs during the first 7 days (Dipiro et al, 2009).

Table 2. The Duration Distribution of Acute Phase in The Research Subject

Duration Acute Phase (Day)	Frequency	Percent (%)	Cumulative Percent (%)
1	23	57.5	57.5
2	9	22.5	80.0
3	7	17.5	97.5
8	1	2.5	100.0
Total	40	100.0	

### 3.2. The Comparison of Effectiveness between Haloperidol Combination Therapy with Risperidone Combination Therapy based on PANSS-EC Score

Our results have shown that the PANSS-EC scores in both treatment groups there was no significant difference ( $p=0.711$ ) (Table 3). The results of this study do not correspond with the results of research conducted by Leucht et al (2009), where the results of a meta-analysis that has been conducted shows that 53% of patients who received risperidone doses above 6 mg per day meets the criteria of improvement compared to 40% of patients who received conventional antipsychotics ( $p<0.001$ ). Treatment with risperidone also results in a 25% better against positive symptoms and 60% better against the negative symptoms compared with conventional antipsychotics. The results of the meta-analysis showed that risperidone meet the criteria of positive symptom improvement is better than the conventional antipsychotics ( $p <0.001$ ).

Table 3. Analysis of Post-test PANSS-EC Scores between Haloperidol Combination Therapy with Risperidone Combination Therapy

	Drugs	n	Mean PANSS-EC Score	Sig. (2-tailed)
Post-test	Risperidon group	20	21.18	0.711
	Haloperidol group	20	19.83	
	Total	40		

The reason of our result may be because this study used the combination therapy, not a single therapy. In addition, both types of antipsychotics are equally effective for treating the positive symptoms in schizophrenic patients, although in the risperidone (an atypical antipsychotic) actually has a high effectiveness for treating positive symptoms and negative symptoms (Harvey et al, 2016). Both types of antipsychotics are also effective in blocking the dopamine receptor type 2 (D2) that is specific mesolimbic dopamine pathway. Blocks the action of dopamine receptor type 2 has the effect of lowering the hyperactivity in the path that led to the emergence of psychotic positive symptoms (Stahl, 2003).

Positive symptoms more prominent that the dopamine receptor type 2 which will play a role in the acute phase, so that the positive symptoms is needed D2 receptor blockade. The combination of Haloperidol and Chlorpromazine is suitable for both work the same way that blocks the D2 receptor, whereas risperidone in addition to blocking the D2 receptor also block the receptor 5-HT2 (Stahl, 2003). It may make both types of therapy are equally effective for the treatment of schizophrenia, because most patients in this study come with positive symptoms dominan in the acute phase, and in this study the researchers did not differentiate patients with schizophrenia acute phase based on the initial symptoms appear.

### 3.3. The Comparison of Cost-Effectiveness between Haloperidol Combination Therapy with Risperidone Combination Therapy

The results of cost-effectiveness comparison between haloperidol combination therapy with risperidone combination therapy have been conducted showing haloperidol combination therapy more cost-effective than risperidone combination therapy (table 4).

Table 4. Cost-effectiveness Comparison between Haloperidol Combination Therapy with Risperidone Combination Therapy

Cost	Risperidon Therapy	Haloperidol Therapy	Sig.
<i>Mean</i>	Rp 31.191,40	Rp 11.186,95	0.010
<i>Maximum</i>	Rp 7.598,00	Rp 3.223,00	
<i>Minimum</i>	Rp 139.560,00	Rp 18.995,00	

Based on statistical analysis Mann-Whitney test according to table 4 showed p value=0,010, it means there is a significant difference between the cost of haloperidol combination therapy with risperidone combination therapy. When compared with the effectiveness of the therapy according to the score of the PANSS-EC in this study, the effectiveness of Haloperidol combination therapy was same with risperidone combination therapy, so if the analysis is done using a table of alternative cost-effectiveness (Table 5) obtained the results of the cost-effectiveness of Haloperidol combination therapy more lower cost than Risperidon combination therapy.

Table 1. Table Cost-Effectiveness Analysis

	Low Cost	Same Cost	High Cost
Low effectivity	A	B	C
	D	E	F
Same effectivity	Haloperidol combination to Risperidon combination		Risperidon combination to Haloperidol combination
High effectivity	G	H	I

Based on Table 5, where the cost-effectiveness of the Risperidone combination therapy compare with Haloperidol combination therapy is in group F, so no need to use RIEB calculation. The layout of the cost-effectiveness of the combination therapy Haloperidol against risperidone combination therapy is in group D, so that the cost-effectiveness of Haloperidol combination therapy better than risperidone combination therapy.

## 4. Conclusion

This study showed that there was no difference of effectiveness when using haloperidol combination or risperidone combination in the acute phase of schizophrenia patients based on PANSS – EC, but the results of cost-effectiveness analysis showed haloperidol combination therapy more cost-effective than risperidone combination therapy on the acute phase of schizophrenia patients.

In this study has not been able to analyze the other factors that also affect the prognosis of the treatment of patients with schizophrenia as the onset of disease, chronicity, precipitating factors, heredity, social, economic, and type of schizophrenia, so more research is needed.

## Acknowledgements

The authors are grateful to the Universitas Muhammadiyah Yogyakarta for the research grants Lecturer and Student 2015 to provide grant for this work.

## References

- Arif, I S. (2006). Skizofrenia. Bandung: PT.Refika Aditama
- Dipiro, J.T., Wells, B.G., Schwinghammer, T.L., & Dipiro, C.V. (2009). Pharmacotherapy handbook. (7<sup>th</sup> ed.). New York: McGraw-Hill Medical.
- Fahlian Vishnu. (2011). The Difference Of Frequency Of Young Age And Old Age Schizophrenia's Patients On May2010–May2011 At Grhasia Hospital Yogyakarta. Karya Tulis Ilmiah, Universitas Islam Indonesia. [Http://www.academia.edu/6929569](http://www.academia.edu/6929569)
- Harvey RC<sup>1</sup>, James AC<sup>2</sup>, Shields GE<sup>3</sup>.(2016). A Systematic Review and Network Meta-Analysis to Assess the Relative Efficacy of Antipsychotics for the Treatment of Positive and Negative Symptoms in Early-Onset Schizophrenia. *CNS Drugs*.;30(1):27-39. doi: 10.1007/s40263-015-0308-1.
- Hawari, D. (2007). Pendekatan Holistik pada Gangguan Jiwa Skizofrenia. Jakarta: Balai Penerbit FKUI.
- Jarut, Yulia Maria, Fatimawali Fatimawali, and Weny I. Wiyono. (2013). Tinjauan Penggunaan Antipsikotik pada Pengobatan Skizofrenia di Rumah Sakit Prof. Dr. VL Ratumuyang Manado Periode Januari 2013-Maret 2013. *Pharmacon 2.3* : Manad.
- Leucht, S., Komossa, K., Rummel-Kluge, C., Corves, C., Hunger, H., Schmid, F., ... Davis, J. M. (2009). A meta-analysis of head-to-head comparisons of second-generation antipsychotics in the treatment of schizophrenia. *American Journal of Psychiatry*, 166(2), 152-163. DOI: 10.1176/appi.ajp.2008.08030368
- Lindenmayer JP, Bossie CA, Kujawa M, Zhu Y, Canuso CM. (2008). Dimensions of psychosis in patients with bipolar mania as measured by the positive and negative syndrome scale. *Psychopathology*, 4:264–270.
- Melatiani, Sutrisna, E., & Azizah, T. (2013). Analisis biaya pada pasien skizofrenia rawat inap di Rumah Sakit "X" Surakarta tahun 2012. Karya Tulis Ilmiah, Universitas Muhammadiyah Surakarta, Surakarta.
- Michal Hrdlicka and Iva Dudova. (2015). Atypical antipsychotics in the treatment of early-onset schizophrenia. *Neuropsychiatr Dis Treat*. 2015; 11: 907–913.
- Reverger, MJ. (2012). Perbandingan Performa Fungsi Pasien Skizofrenia yang Mendapat Terapi Tunggal dengan Terapi Kombinasi Antipsikotika di Rumah Sakit Cipto Mangunkusumo (Periode Desember 2011-Mei 2012). Tesis FKUI.
- Sinaga, B R. (2007). Skizofrenia dan diagnosis banding. Jakarta: Balai Penerbit FKUI
- Stahl, S. M. (2003). Describing an atypical antipsychotic: receptor binding and its role in pathophysiology. *Prim Care Companion J Clin Psychiatry*, 5(suppl 3), 9-13.

- Tandon R<sup>1</sup>, Gaebel W, Barch DM, Bustillo J, Gur RE, Heckers S, Malaspina D, Owen MJ, Schultz S, Tsuang M, Van Os J, Carpenter W. (2013). Definition and description of schizophrenia in the DSM-5. *Schizophr Res.* Oct;150(1):3-10. doi: 0.1016/j.schres.2013.05.028. Epub 2013 Jun 22.
- Wu EQ<sup>1</sup>, Birnbaum HG, Shi L, Ball DE, Kessler RC, Moulis M, Aggarwal J. (2005). The economic burden of schizophrenia in the United States in 2002. *J Clin Psychiatry.* Sep;66(9):1122-9.

---

**Optimization of the Acid Catalyst Concentration for Synthesis of  
Anti-Cancer Agent Gamavuton-0 by Using Mathematical and  
Statistical Software**

Sabtanti Harimurti\*, Hari Widada, Ismanurrahman Hadi, Didy Putra Wijaya

*School of Pharmacy, Faculty of Medicine and Health Sciences, Universitas Muhammadiyah  
Yogyakarta, Jalan Lingkar Selatan, Tamantirto, Kasihan, Bantul, Yogyakarta, 55183,  
INDONESIA*

---

**Abstract**

Cancer is a condition that occurs due to abnormal growth of cells in the body. One of the compounds that potentially developed as anticancer agent is Gamavuton-0 (GVT-0). GVT-0 is a curcumin's analog compound. This compound can be synthesized by a reaction of one mole of acetone and two moles of vanillin as starting materials using acid or base catalyst. The main purpose of this research is to determine the best concentration of the acid catalyst for the synthesis of GVT-0. Synthesis was carried out in the round bottle flask with heating. The dissolved of 4.14 gram of vanillin in ethanol was mixed with one milliliter of acidified acetone. The concentration of acid catalyst (HCl) that was used is 2 ppm, 4 ppm, 6 ppm, and 8 ppm of acetone, respectively. The heating was conducted for 1.5 hours and then let it cool in the refrigerator for overnight at 1-10 °C. After that, the purification process can be conducted. In this purification, the hot water maceration method was used. In the finding of the best concentration of acid catalyst, the mathematical and statistical Stratigraphic Centurion 15 software was used. The analysis that was used in this research is regression polynomial second order. The result of the analysis showed that the maximum GVT-0 produced was 2.66 gram at acid catalyst concentration was 5 ppm of acetone.

**Keywords**

GVT-0, HCL, catalyst, cancer, regression

---

**1. Introduction**

The number of cancer incidence increase in the recent years. National Cancer Institute predicts as much as 1,685,210 new cases of cancer will be diagnosed in the United States and 595,690 people will die because of the disease. Breast, lung cancer and prostate cancer are the most common cancers incident predicted (NCI, 2016). Cancer may be a hereditary diseases (Suryohudoyo, 2004) but incorrect lifestyle such as smoking and consuming instant foods and drinks often increase the incident of cancer significantly (Ministry of Health of Indonesia, 2015).

---

\* Corresponding author. Tel.: +6285643842082; fax: +62-274-387646.  
E-mail address: [sabtanti@umy.ac.id](mailto:sabtanti@umy.ac.id), [sabtanti@gmail.com](mailto:sabtanti@gmail.com)

Developing of anticancer drug is urgently conducted to help the patient to fight the cancer. One of the new compound that possible to be developed as anticancer is Gamavuton-0 (GVT-0) (Agrawal and Mishra, 2010). Nugroho et.al. (2009) reported that GVT-0 has a cytotoxic activity and anti-proliferation activity on the leukemia basophil cell in rat. Also, GVT-0 has been reported has a higher potency as anti-free radical compared to curcumin (Yuniarti, 2000). GVT-0 is one of the analogues of curcumin with better stability compare to curcumin without losing its anticancer effect. GVT-0 along with other curcumin analogues for several years has been widely studied on the pharmacological effectiveness. The efficacy as an anti-inflammatory agent has been reported to be higher than the curcumin and phenylbutazone (Sardjiman, 2000).

Synthesis of GVT-0 is done by modifying of the structure of the middle of (1,7-diphenyl-1,6-heptadien-3,5-dion) in curcumin into (1,5-diphenyl-1,4-pentadien-3-one) on GVT-0. GVT-0 has a shorter carbon chain bridge than curcumin, carbonyl group and without methylene group. Based on the disconnection analysis of the structure, GVT-0 can be synthesized by reacting two molecules of vanillin and one molecule of acetone. The reaction mechanism follows the reaction mechanism of Claisen-Schmidt condensation (Sardjiman, 2000).

The crucial problem during synthesis is commonly occur on the optimization process to obtain the best value of many parameter affecting the reaction, such as concentration of starting material, temperature, concentration of catalyst, duration of heating, and etc. Recently, many researchers use statistical and mathematical software to overcome the problem, since the conventional method commonly requires time for conducting the experiment and high cost for experimental materials. By utilizing the software, the number and the cost of the experiment will be reduced. In addition, the software can be used to analyze the effect of varying value of parameter studied toward the response by generating a mathematical model and statistical analysis (Harimurti et al, 2012).

Based on the advantages of utilizing of mathematical and statistical software for the optimization process, therefore in this present work the software will be used for determining the best acid catalyst concentration during synthesis of GVT-0.

## **2. Materials and Methods**

### *2.1. Apparatus*

The apparatus that was used for the synthesis of GVT-0 were Beaker glass (Pyrex), test tubes (Pyrex), Erlenmeyer (Pyrex), round-bottom flask (Pyrex), funnel, porcelain bowls, condenser, magnetic stirrer CIMAREC®, heat mantle KDM-1000®, filter paper, 1 and 5 ml pipette volume, pipette filler, white tip, pH universal indicator, micropipette Socorex Swiss, silica gel GF254 TLC plate, TLC chamber, and computers equipped with Portable software Statgraphics Centurion.

### *2.2. Materials*

During experimental work, the materials that were used in the synthesis of GVT-0 were aniline technical grade (Brataco®), acetone for synthesis (Sigma Aldrick®), concentrated hydrochloric acid 37% (Merck®), glacial acetic acid for analysis (Brataco®), Na sulfate anhydrous for analysis (BRATACO ®), Chloroform for analysis (Merck®), ethanol for analysis (Sigma Aldrick®) and distilled water (Brataco®)



### 2.3. Synthesis of Gamavuton-0 (GVT-0)

Synthesis of GVT-0 was carried out in a round bottle flask with condenser by varying the acid catalyst concentration (2 ppm, 4 ppm, 6 ppm, and 8 ppm, respectively) while keeping constant of heating period (1.5 hours), heating level (4.5 scale) and ratio of vanillin and acetone (2:1). Vanillin that was used as much as 4.141 grams and acetone as much as 1 ml. Before reaction, Vanillin was dissolved in the ethanol 95% using a magnetic stirrer until dissolved. In the other hand, a designed value of concentrated HCl (acid catalyst) was added into acetone, separately. The HCl that was added was 20  $\mu$ L, 40  $\mu$ L, 60  $\mu$ L and 80  $\mu$ L for 10 ml of acetone, respectively. Thus the concentration of HCl was 2 ppm, 4 ppm, 6 ppm and 8 ppm, respectively. Further, 1 ml acetone was taken from the mixture of acetone-HCl and then added into dissolved vanillin in a round bottle flask that was prepared with condenser. Heating at scale of 4.5 was setup. Cooling was done by turning on the water cooling through condenser. The duration of reaction was stopped after 1.5 hours and the end of the reaction can be identified by forming a brownish yellow solution. The obtained solution was cooled in the refrigerator at 1-10°C for 12 hours.

### 2.4. Purification of GVT-0

The GVT-0 purification was carried out using maceration method. The yellowish crystal formed after cooling then dissolved using chloroform and then transferred into a separating funnel for settling up. The chloroform phase was further transferred into evaporating porcelain. Removing chloroform and trace water was done by adding Na-Sulfate anhydrate and then putting the evaporating porcelain on the boiling water bath until getting a greenish-black residue. After that, the residue was added glacial acetic acid and then added with distilled water until forming a greenish yellow crystalline compound. The crystal was purified one more time to get purer crystal by hot water maceration process at 70-80 °C. Last the brownish yellow crystal then filtered for drying and weighing.

### 2.5. Purity analysis

The purity analysis was performed using Thin Layer Chromatography (TLC). The purified GVT-0 and vanillin were elucidated on the Silica gel GF 254 plate. Mobile phase that was used is chloroform and ethyl acetate at ratio 5:1 (Fahrurozi, 2008). The distance of elucidation was 8 cm. The detection of the spot was conducted using visible light and UV light at  $\lambda$  254 and 366 nm, respectively. The retardation factor (Rf) of the spot was calculated using Equation (1) as follows:

$$Rf = \frac{\text{mileage of sample}}{\text{mileage of mobile phase}} \quad (1)$$

### 2.6. Optimization of acid catalyst concentration

Optimization of the acid catalyst concentration was performed by utilizing mathematical and statistical software named Statgraphics Centurion software. Regression polynomial second order of the data obtained was performed to determine

the correlation model between acid catalyst concentration and the GVT-0 produced as well as to determine the optimum catalyst concentration for the maximum of GVT-0 produced. Quality of the fit data to the second order equation was expressed by determination of  $R^2$ . The statistical significance (P-value) was analyzed using analysis of variance (ANOVA). In this experiment, the P-value was designed not more than 10%. The P-value was designed at this high since the synthesis through very complicated process.

### 3. Results and Discussions

Vanillin and acetone as starting materials were selected based on the disconnection analysis of GVT-0 structure. The GVT-0 can be divided into one molecule of acetone and two molecules of vanillin. Methyl group of Acetone will be connected to carbonyl group of vanillin to form a C = C bond through Claisen-Schmidt reaction mechanism. Acid or base are commonly used as the catalyst of the reaction (Fessenden and Fessenden, 1999; Tonnesen and Karlsen, 1985). Modified Samtisar method was used during the synthesis of GVT-0. Fahrurozi (2008) reported that the modification of the method Samtisar had done by changing the reaction procedure, i.e. the crystal of vanillin was firstly dissolved in the 95% of ethanol before reaction. The previous procedure was conducted by direct mixing of vanillin crystal into the acidified acetone.

Synthesis of GVT-0 was started by calculating the required starting materials (vanillin and acetone) for reaction. Theoretically, the GVT-0 is developed from two molecules of vanillin and one molecule of acetone (2:1). Based on the theoretical ratio of starting materials, the 4,141 grams of vanillin and 1 ml of acetone were used. In this synthesis, hydrochloric acid (HCl) 37% (concentrated) was used as the catalyst. The main purpose of acid catalyst in the reaction is for reducing the electronegativity of carbonyl group of acetone. Therefore, the possibility of the reaction is easier to be done. Acid catalyst is more favorable since the reaction process is more stable compare to the base catalyst (Fessenden and Fessenden, 1999). The yellow-green crystal of GVT-0 obtained from the synthesis can be seen in Figure 1. This result is in accordance with the previous research that was conducted by Fahrurozi in 2008.

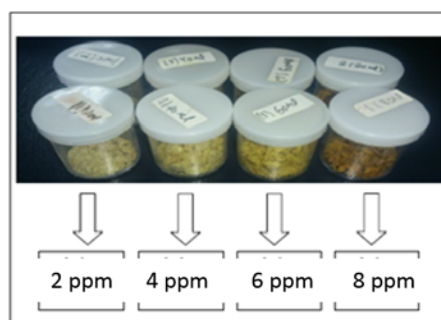

Figure 1. GVT-0 Crystal

Identification of the purity of GVT-0 from the synthesis was analyzed using Thin Layer Chromatography (TLC). The TLC result can be seen in Figure 2. In the Figure 2 can be observe that the GVT-0 produced still impure, where the vanillin as the starting material still found. This may happen because of the purification process not completely achieved. The vanillin contamination can be identified from the spot on the TLC silica, which is containing two spots (GVT-0 and vanillin). The  $R_f$  of GVT-0 was found to be 0.5. This  $R_f$  was the same with the  $R_f$  for GVT-0 reported by Fahrurozi (2008).

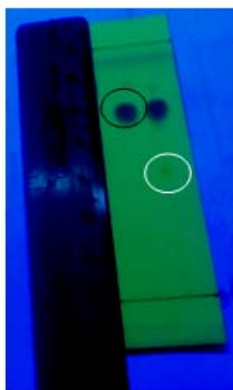

Figure 2. TLC of GVT-0 (yellow) and vanillin (purple) as the standard

The GVT-0 obtained from the synthesis at varying HCl concentration was arranged in Table 1.

Table 1. Obtained GVT-0 from the synthesis

Sample	Vary of HCl concentration (ppm)	GVT-0 (g)	Average (g)
1	2	0.49	0.50
2	2	0.51	
1	4	2.25	2.48
2	4	2.99	
1	6	2.54	2.39
2	6	2.25	
1	8	0.75	0.76
2	8	0.77	

Table 2 is the ANOVA result of the obtained data from the experiment. ANOVA was conducted to determine the variation of the data. The significant variation of the data can be evaluated from the P-value. The P-value indicates the significance of the relationship between independent parameter and the response variable (Daneshvar, 2007). Based on the ANOVA results, there is significant difference between the data that has been obtained. The significant difference can be identified from the P-value generated from the analysis, i.e. 0.0633 (P-value). This result is less than the acceptable quality level (AQL) of ANOVA that was set up at P-value of 0.1. That means there is a significant relationship between the variations of acid catalyst concentration and GVT-0 produced. In the other word, by changing the acid concentration significantly change the GVT-0 produced.

Table 1. Result of analysis of variance (ANOVA)

Source	Sum of squares	df	Mean square	F-Ratio	P-value
Model	3.28037	2	1.64018	120.90	<b>0.0633</b>
Residual	0.0135668	1	00135		
Total(Corr.)	3.29394	3			

Regression analysis was chosen as a method for hypothesis testing based on its ability to measure of the strength of the relationship between the response variable and the predictor variables, determine the influence of one or several variables predictors of response variables, and was useful for predicting the effect of a variable or multiple response variables (Iriawan and Astuti, 2006).

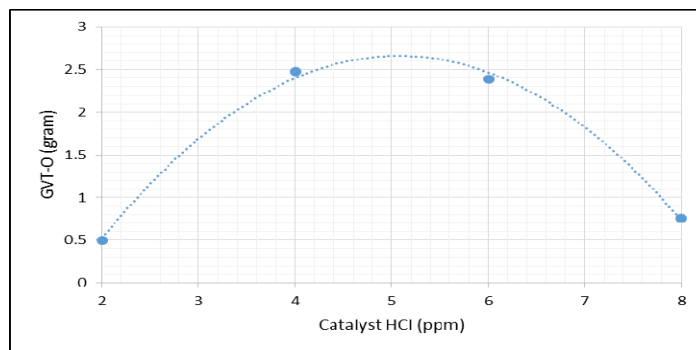

**Figure 3.** Plot of catalyst concentration vs GVT-O (R-squared = 99.5881 percent; R-squared (adjusted for df.) = 98.7644)

Correlation of the acid catalyst concentration (X) and the GVT-0 produced (Y) can be plotted as shown in Figure 3. The R-Squared value of the plot data was found to be 99.5881, means that the GVT-0 produced following the mathematical model generated very well. The analysis using regression polynomial second order gave an equation as expressed as Equation 2. The use of the equation is for predicting the GVT-0 produced once the concentration of catalyst is known at the experiment set up as mentioned above. When the Equation 2 assumed to be  $Y = aX^2 + bX + c$ , the highest value of Y will be reached when the value of  $X = -b/2a$ . Based on the Equation 2, calculation of the optimum value of X was found to be 5.08 ppm.

$$Y = -0.2256X^2 + 2.2908X - 3.1525 \quad (2)$$

Figure 3 shows that by increasing the catalyst concentration increase the GVT-0 produced. At the optimum concentration of catalyst, the GVT-0 produced was the highest one, this may due to at the optimum concentration the fastest reaction rate was occurred. Still increase the catalyst concentration at 6 ppm and 8 ppm, the rate of the reaction decreasing. The decrease of the rate of reaction can be detected by reducing the GVT-0 produced.

Equation 2 can be used to predict the theoretical amount of GVT-0 produced once the acid catalyst concentration is known. By using Equation 2, GVT-0 predicted at optimum acid catalyst concentration of 5.08 was found to be 2.66 grams. The calculation process can be conducted as follows:

$$Y = -0.2256X^2 + 2.2908X - 3.1525$$

$$Y = -0.2256(5.08)^2 + 2.2908(5.08) - 3.1525$$

$$Y = 2,66 \text{ gram (predicted)}$$

Validation of the equation can be conducted by carrying out an experiment using a theoretical condition suggested. During the experiment using 5.08 ppm of acid catalyst concentration, the GVT-0 produced was 2.69 grams. The comparison between the predicted to the experimental results can be seen in Figure 4.

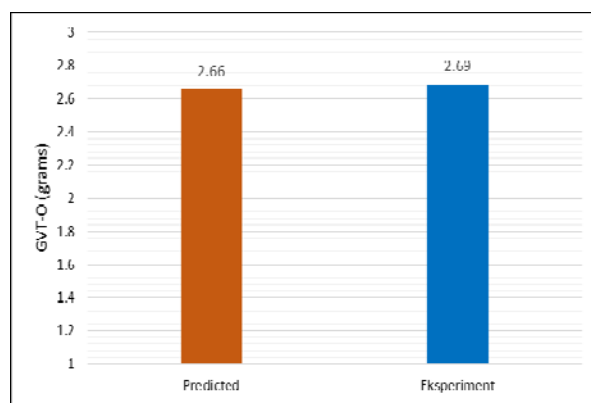

The difference between predicted and experiment of GVT-0 produced can be calculated using Equation 3.

$$\text{The difference} = \frac{\text{experiment} - \text{predicted}}{\text{predicted}} \times 100\% \quad (3)$$

The difference of GVT-0 produced is 1.22%. This indicates that the equations obtained can be used to predict the number of GVT-0 desired when the acid catalyst concentration is known. This data will be very useful for further optimization process on finding the other optimum condition of parameter during the synthesis. Surely, this result will be very useful in proposing of production in the industry with larger scale.

## Conclusion

Based on the experimental results, by using mathematical and statistic software the experiment was more efficient and the best acid catalyst concentration was found to be 5 ppm at the setup of experimental condition.

## Acknowledgements

The financial and facility support to the author from Universitas Muhammadiyah Yogyakarta is highly acknowledged.

## References

- Agrawal D.K., Mishra P. K., (2010). Curcumin and its analogues: potential anticancer agents. *Med Res Rev.* 2010 Sep; 30(5):818-60.doi: 10.1002/ med. 20188. (<http://www.ncbi.nlm.nih.gov/pubmed/20027668>). Accesed on 22<sup>nd</sup> May 2014.
- Daneshvar, N., Behnajady, M. A., Asghar, Y. Z., (2007). Photooxidative Degradation of 4-nitrophenol (4-NP) in UV/H<sub>2</sub>O<sub>2</sub> Process: Influence of Operational Parameters and Reaction Mechanism, *J. Hazard. Mater.*, vol. B139, p. 275-279
- Fahruruzi, (2008). The influence of mole concentration of reactant on the gamavuton-0 synthesis using ethanol as the solvent and cytotoxic test toward He La cell, Final year project, (*Pengaruh jumlah mol pereaksi pada sintesis senyawa gamavuton-0 dengan pelarut etanol*)

- dan uji sitotoksik terhadap sel HeLa*), Final year project (Skripsi), Universitas Gadjah Mada, Yogyakarta.
- Fessenden, R.J., and Fessenden, J.S., (1999). *Organic Chemistry, Volume 2*, Translated by Pudjaatmaka A.H., Erlangga Publisher, Jakarta.
- Harimurti, S., Rahmah, A. U., Omar, A. A., Murugesan, T., (2012). Application of Response Surface Method in the Degradation of Wastewater Containing MDEA Using UV/H<sub>2</sub>O<sub>2</sub> Advance Oxidation Process, *J. Appl. Sci.*, vol. 12 (11), pp 1093–1099
- Iriawan, N. S. Dan Astuti, P. (2006). *Mengolah Data Statistika dengan Mudah Menggunakan Minitab 14*. Yogyakarta
- Ministry of Health of Indonesia (2015). *Situasi Penyakit Kanker*, Center of Data and Information, Ministry of Health of Indonesia, Jakarta.
- National Cancer Institute, (2016). Cancer statistics, assessed on 23<sup>th</sup> October 2016, <https://www.cancer.gov/about-cancer/understanding/statistics>.
- Nugroho, A., (1998). Synthesis of 2-5-Bis(4'-Hydroxy-3'-Methoxybenzylidene) cyclopentanone on the vary of temperature at mixing step (*Sintesa 2-5-Bis(4'-Hidroksi-3'-Metoksibenzilidin) Siklopentanon dengan variasi suhu 28° C, 38° C, 48° C pada Fase Pengadukan*), Final year project (Skripsi), Faculty of Pharmacy, Gadjah Mada University, Yogyakarta.
- Sardjiman, (2000). Synthesis of Some New Series of Curcumin Analogues, Anti-oxidative, Anti-inflammatory, Antibacterial Activities and Quantitative-Structure Activity Relationship. Dissertation. Gadjah Mada University. Yogyakarta.
- Suryohudoyo P., (2004). Basic Carcinogenesis Molecular (Dasar Molekuler Karsinogenesis), in the : *Capita Selecta Molecular Medicine (Kapita Selektta Ilmu Kedokteran Molekuler)*, Infomedika Publisher , Jakarta.
- Tonnesen H.H, Karlsen J., (1985). Studies on Curcumin and Curcuminoids: Alkaline Degradation of Curcumin. *Z. Lebens. Unters Forsch* 180: 132-134.
- Yuniarti N. (2006). Aktivitas antiinflamasi invivo dan invitro 1,5-bis(4'-hidroksi-3'-etoksifenil)-1,4-pentadien-3-on Indometasin dan turunannya. Tesis. Yogyakarta: Universitas Gadjah Mada.

---

**EFFERVESCENT TABLET FORMULATION OF PURPLE  
MANGOSTEEN (*GARCINIA MANGOSTANA L*) AND APPLE (*PYRUS  
MALUS L*) PEEL EXTRACTS**

**MT Ghozali<sup>a</sup>, Rischa Ayuningsih<sup>b</sup>**

<sup>a</sup>Universitas Muhammadiyah Yogyakarta, Yogyakarta 55282, Indonesia

<sup>b</sup>Universitas Muhammadiyah Yogyakarta, Yogyakarta 55183, Indonesia

---

**Abstract**

Purple mangosteen and apple are the two most popular fruits in Indonesia, but very few consume the peel, which is arguably the healthiest part of the whole fruit. Both purple mangosteen and apple peels are rich in antioxidants, which contribute many of their health benefits. People generally use the peels for many purposes, either medical or non-medical, by brewing, boiling, and juicing. To make the peels easier to take, the formulation of effervescent tablet is needed. This research aimed to get the optimum effervescent tablet formula of purple mangosteen and apple peel extract, which fulfils the requirement of standard effervescent tablet and physical evaluation. The extraction method in this research is maceration, which used ethanol 70% as the solvent. The process of this effervescent tablet used a wet granulation that optimizes various formulas to get the best one. The analysis of physical effervescent tablet properties used theoretical approach. The result of this study concluded that the best effervescent tablet formula of purple mangosteen and apple peel extract contained citric acid, tartaric acid, sodium bicarbonate with the ratio of 1:2:3. Meanwhile, the results of physical evaluation showed that the content uniformity of the effervescent tablets was 3.050 gram, the hardness test was 6.489 kg/cm<sup>2</sup>, the friability test was 0.05%, and the solubility test was 1.73 minutes.

**Keywords**

Purple mangosteen; apple; effervescent; tablet; formulation

---

**1. Introduction**

Purple mangosteen (*Garcinia mangostana L.*) is a functional plant, since most parts of it can be used for both medicinal and non-medicinal purposes. The peel of it, which is usually discarded as a waste, has a number of essential health benefits. It is rich in antioxidants, including anthocyanins and xanthones (Moongkarndi et al., 2004).

Apple (*Pyrus mallus L*) is a fruit that is rich in various phytochemical substances; one of them is flavonoids (Boyer et al., 2004). Other studies had confirmed that the peel of apple has a higher antioxidant property than its flesh. (Simamora, 2009).

People have traditionally used purple mangosteen peel by steeping and bringing to a boil, while apple peel is by juicing. The proper formulation in processing natural ingredients into a simple preparation easily accepted by society is expected to improve the practicality and interest in using natural medicine.

One of the efforts to improve them is to formulate these natural ingredients into effervescent tablets. Some of main advantages of effervescent tablets is that it is easy to prepare and does contain the proper dose. Effervescent tablets also produce a good taste, since their carbonates help improve the taste of certain drugs (Lachman et al., 1994).

The main purposes of this study were to formulate the peel extracts of purple mangosteen and apple into effervescent tablet and to test their physical properties.

## **2. Methods**

### *2.1. Materials*

Materials used in this study came in two types, namely active and additive. Active ingredients were peel extracts of purple mangosteen and apple, while additives included tartaric acid, citric acid, sodium bicarbonate, mannitol, aspartame, PVP, magnesium stearate, and lactose.

### *2.2. Tools*

Some tools used in this study included rotary evaporator (IKA®), some glass tools (Pyrex®), some containers for granulation, mortar and stamper, type GT/GTB granulate flow tester (Erweka®), digital stopwatch, hardness tester (Stokes Monsanto®), friability tester (TA- 10/TA-20), moisture balance MB45 (Ohaus®), analytical scales AR2140 (Ohaus®), oven (Mettler drying oven), sieves no. 14 and 20 type AT-340 (Indotest Multi Laboratama®), and single punch tablet press (Korsch®).

## **3. Procedures**

### *3.1. Extraction*

Powdered peels were extracted with a maceration method using 70% ethanol. It was done by immersing the peels into 70% ethanol for 5 days and stirring every day for the perfect results. After 5 days, the extracted peels were filtered and re-macerated for 2 days to optimize them. The macerated extracts were entirely evaporated using a rotary evaporator to obtain thickened extracts, then weighed with an analytical scale.

### *3.2. Granule Preparation*

Preparing effervescent granules of purple mangosteen and apple peel extracts was done by weighing thick extracts mixed with lactose and then preparing mass of wet granules using PVP by sieving the ingredients with sieve no. 14 and then drying them with a temperature of about 40-60°C for 24 hours. After dried, granules were re-sieved with a sieve no. 20. The mixture was put into an oven at 50°C for an hour, so it will be melted. Dried granules obtained were sieved with sieve no. 20.

### *3.3. Formulation*

Effervescent tablets of purple mangosteen and apple peel extracts were made in one formula (Formula I), but after evaluation of granule, physical, and organoleptic



properties, they did not meet the standard requirement. So, they should be optimized. The results of the formula I optimization were formula II and formula III.

Table I is a reference formula that had been researched by Hidayati (2007). The formula contained extracts, lactose, citric acid, tartaric acid, potassium bicarbonate, magnesium stearate, aspartame, and PVP. In this study, there are some differences and changes of the formula, namely adding additives, such as sodium bicarbonate and mannitol. Sodium bicarbonate is a frequently-used alkali (base) source, while mannitol provides a cooling sensation in the mouth (Rowe et al., 2006).

Table 1. Formulation of effervescent tablet

Ingredients	Functions	Formula I (%)
Purple mangosteen and apple peel extracts	Active ingredient	4
Lactose	Filler	29.43
Aspartame	Sweetener	1.67
Citric acid	Acid source	15
Granule extra	Crusher	0.3
Sodium bicarbonate	Base source	30
Granule extra	Crusher	0.6
Magnesium stearate	Lubricant	0.9
Mannitol	Sweetener	1.67
PVP	Binder	0.02

### 3.4. Effervescent Tablet Preparation

Effervescent granules obtained were pressed with a single punch tablet machine. Both tablets and all tablet tests were done with relative humidity of 45-50%. The weight of each tablet that will be created was 3000 milligrams.

## 4. Result and Discussion

### 4.1. Extract preparation

The extraction method used in this study was maceration. The solvent used in this maceration was 70% ethanol. The yield of the resulting purple mangosteen peel extract was 11.11%, while apple was 20.45%. It showed that there were polar compounds in the peel of purple mangosteen (*Garcinia mangostana* L) and apple (*Pyrus mallus* L). It means that these compounds are soluble in ethanol. The extraction used 70% ethanol because desired thickened extracts had polar properties. The terms of ingredients used in this study were water soluble, so polar thickened extracts will be easily dissolved.

### 4.2. Optimization and Scale Up

The effervescent tablet optimization used in this study was a formula design as presented on the table 2. This optimization was done in the preparation and formula of the effervescent tablets. Unfortunately, the physical parameters of the formula I were less good, so the formula needs to be optimized.

Table 2. Optimized formula of effervescent tablets

Ingredients	Formula (%)		
	I	II	III
Purple mangosteen and apple peel extracts	4	4	4
Lactose	29.43	26.1	16.76
Aspartame	1.67	2.6	2.6
Citric acid	15	15	11.57
Granule extra	0.3	0.3	0.3
Tartaric acid	15	15	23.1
Granule extra	0.3	0.3	0.3
Sodium bicarbonate	30	30	34.67
Granule extra	0.6	0.6	0.6
Magnesium Stearate	0.9	0.9	0.9
Mannitol	1.67	5.6	5.6
PVP	0.2	0.167	0.015
Tween 80	0	0.017	0.017

**NOTE:**

Formula 1: Tablet preparation with wet granulation without phase separation.

Formula 2: Tablet preparation with wet granulation with phase separation.

Formula 3: Tablet preparation with wet granulation with phase separation.

Based on the Table 2 above, the formula I was a basic formula. The preparation of this formula was done using a wet granulation method without a phase separation. The formula I produced tablets that did not meet the standard requirements of good manufacturing effervescent tablets (Table 3).

Table 3. The result of effervescent tablet physical test

F	Weight Uniformity (mg)		Friability (%)	Hardness (kg/cm <sup>3</sup> )	Dissolve Time (minutes)
	A (5%)	B (10%)			
F1	3.038 ± 0.152	3.038 ± 0.304	2.12	4.21	3.36
F2	3.045 ± 0.152	3.045 ± 0.303	0.06	7.453	24.48
F3	3.050 ± 0.153	3.050 ± 0.305	0.05	5.496	1.73
Scale Up	3.073 ± 0.154	3.073 ± 0.307	0.31	6.489	1.83

The formula II was obtained after optimizing formula I. This second formula used a wet granulation method with a phase separation. Changes in this method were done to avoid any undesired reaction of the effervescent. In formula II, surfactants tween 80 were added into the formula to overcome the solubility of the extracts. The formula II produced a good tablet. However, one of the physical parameters of this formula, which did not meet the requirement, was the dissolve time. Based on this evaluation, further optimization needs to be done to obtain a qualified formula.

Optimization of the formula III was done by changing the concentration of the acid and alkaline source. It contained more sodium bicarbonate compared to formula I and II. The formulation changes aimed to improve dissolve time of the effervescent tablets. The result showed that formula III met all the requirements, so a scale up could be done.

Based on Table 3, formula I tablets produced a weight uniformity that met all the requirements of the 4<sup>th</sup> Indonesian Pharmacopoeia, i.e. there are no two tablets that deviate more than 5% of average weight and no one tablet that deviate more than 10% of

average weight. The results of weight uniformity of effervescent tablets had a good CV value, which was less than 6%, so all the formulas had a good weight uniformity. The weight uniformity test showed that formula I produced a good weight uniformity, since it had the lowest CV value (1.119%) compared to other formulas. It might be due to the flow time of formula I that was better than the others (Table 1).

In addition to a good weight uniformity, formula I produced the value of tablet hardness (4.21 kg/cm<sup>2</sup>), friability (2.12%), and dissolve time (3.36 minutes). Hardness test showed that formula I had the lowest value. The difference of such hardness was due to an uneven distribution of liquid binder in all parts of the granules. Liquid binder produced a liquid bridge, which naturally occurred when drying wet granules and would turn into a solid bridge in the granules due to liquid binder that would remain behind, did not evaporate, and would glue granule particles, so that the tablet becomes harder.

The compression will cause granules went into a plastic deformation, so it became a compact mass, namely into tablet form. The effervescent tablet hardness affects the resistance of tablet against mechanical disturbances. Compact or hard tablets were not easily destroyed during distribution and storage (Ansar, 2009).

Besides low hardness value, formula I had a high friability. Friability describes the strength of tablet surface in resisting treatments causing abrasion of the tablet surface. Friability is strongly influenced by tablet hardness.

The friability value of formula I was 2.12%. It was the highest value among other formulas. The differences of friability value were probably caused by differences in the concentration of PVP as a wetting-granule agent. The concentrations used in Formula I as a granulating agent was 5%, while in other formulas was 10%. The concentration differences might affect granule wetting process. In addition, it could be caused by low hardness value and bonding among particles at the surface of the tablet. The greater the percentage of fragility, the more mass will be lost. Loss of tablet mass will affect the amount of active ingredients.

Another characteristic of effervescent tablets, in addition to weight uniformity, hardness, and friability, is dissolve time. It represents the time required by the tablet to be completely soluble in a certain volume of water. The results of the formula I had a dissolve time that did not meet the standard requirement (3.36 minutes). According Mohrle (1980), a good dissolve time ranges from 1 - 2 minutes.

After describing formula I, it was obtained a number of deficiencies that should be corrected, so optimization was needed to produce better formulas. Formula II was the result of the formula I optimization. In formula II, there were some modifications in the concentration and the additive ingredients. Unlike previous formula, the formula II used wet granulation method with a phase separation. The changes were made to avoid early undesired effervescent reaction (Lestari, 2007).

Evaluation of weight uniformity in the formula II produced uniform tablets with CV value less than 6% (1.29%), hardness (7.453 kg/cm<sup>2</sup>), friability (0.06%), and dissolve time (24.48 minutes). The hardness value of the formula II was the highest. It could be due to some solid bridges that were formed, thereby increasing the tablet hardness. Meanwhile, dissolve time of the formula II was the longest. It was due to the storage process of effervescent tablets in the room that has a fairly high relative humidity (45 to 50%), thus causing the reaction of CO<sub>2</sub> with water, resulting in reduced power carbonation when dissolved in the water thus making dissolve time longer.

Physical evaluation of formula III effervescent tablets showed that they had good weight uniformity, their CV value was the highest (1.887%). Fortunately, this value was still less than 6%, so it was still allowed. Formula III had a high CV value because its flow time was fairly long (17 gram/second). Smaller flow time of the granules would support the uniformity of mold-filling (die) by the granules and affect the weight uniformity of the tablet. A perfect flow time will produce good form and weight uniformity tablets (Lachman, 1989).

The percentage of friability, hardness, and dissolve time of the formula III did meet all the standard requirements. The dissolve time of the formula III was different from both formula I and II. The formula III had a dissolve time, which was less than 2 minutes (1.73 minutes). It could be due to the differences of the crushing agent (sodium bicarbonate) concentration. High concentrations of sodium bicarbonate affect the solubility of effervescent tablets. It occurs because sodium bicarbonate serves as a crushing agent when it reacts with water and will produce CO<sub>2</sub> gas, thereby providing a refreshing effect (Ansar, 2009).

The formula III, in addition to having a good weight uniformity value, produced effervescent tablets that did not taste bitter, had a good extract solubility, 3 cm foaming, and a good aroma. Aroma contained in the effervescent tablets was derived from the purple mangosteen peel extract combined with apple peel extract and acidic materials used as raw materials of effervescent tablets.

The optimization of effervescent tablets produced formula III, which had a good granular and physical evaluation value and met the standard requirements. Formula III was an optimum formula, so it was scaled up to 100 tablets. A 100 tablet scale up process produced granular and physical evaluation values that entirely met the standard requirements.

## 5. Conclusion

The effervescent tablet formulation of purple mangosteen (*Garcinia mangostana L*) and apple (*Pyrus mallus L*) peel extracts that met all standard requirements was formula III. The formula contained citric acids, tartaric acids, sodium bicarbonate in the ratio of 1: 2: 3 and filling (lactose), binding (PVP), lubricating (magnesium stearate) agent, and combination of sweeteners, i.e. aspartame and mannitol. The results of the physical evaluation of the formula III were as follows: the average weight ( $3.050 \pm 0.153$ ), hardness (6,489 kg/cm<sup>2</sup>), friability (0.05%), and dissolve time (1.73 minutes). All physical evaluation results of the formula III had met the standard tablet effervescent requirements.

## 6. References

- Ansar, B. Rahardjo, Z. Noor dan Rochmadi, 2009, Optimasi Teknik Pembuatan Tablet Effervescent Sari Buah Dengan Response Surface Method (RSM). J.Teknol. dan Industri Pangan 20(1): 25-31.
- Boyer, Jeanelle., Rui Hai Liu., 2004, Apple Phytochemicals and Their Health Benefits, Nutrition Journal, (3) 5.
- Hidayati, Luthfiya., 2007, Formulasi Tablet Effervescent dari Ekstrak Daun Belimbing Wuluh (*Averrhoa bilimbi L.*) sebagai Anti Hipertensi, Skripsi, Fakultas Teknologi Pertanian, Institut Pertanian Bogor, Bogor.

- Lachman, L., Wadke, D.A., Serajuddin, A.T.M., dan Jacobson, A., 1989, Preformulation Testing, dalam Lieberman, H.A., dan Schwartz, J., B., (Eds), Pharmaceutical Dosage Form : Tablets, Volume 1, 2 nd ed., 55 Marcel Dekker Inc, New York.
- Lachman, 1994. Teori dan Praktek Farmasi Industri. Edisi III. Jilid 2. 1040, 1092- 1094, UI Press, Jakarta.
- Lestari B, Lisa N., 2007, Optimasi natrium sitrat dan asam fumarat sebagai sumber asam dalam pembuatan granul effervescent ekstrak temulawak (*Curcuma xanthorrhiza Roxb*) secara granulasi basah, Majalah Farmasi Indonesia, 18(1), 21 – 28.
- Mohrle, R., 1980, Effervescent Tablet Formulation, Lachman, L., Lieberman, H.A., (Eds), Pharmaceutical Dosage Form: Tablet, Volume 1, 225-257, 284-316, Marcel Dekker, Inc., New York.
- Moongkarndi, P., Kosem, N., Kaslungka, S., Luanratana, O., Pongpan, N., Neungton, N. Antiproliferation, Antioxidation and Induction of Apoptosis by *Garcinia mangostana* (Mangosteen) on SKBR3 Human Breast Cancer Cell Line. J Ethnopharmacol. 2004, 90, 161-166.
- Rowe, C., Sheskey, P.J., dan Quinn, M.E, 2006, Handbook of Pharmaceutical Excipients, fifth Edition, Chicago, Pharmaceutical Press.
- Simamora, Adelina., 2009, Flavonoid dalam Apel dan Aktivitas Antioksidannya, Universitas Kristen Krida Wacana, Jakarta.

**ANTIOXIDANT AND PHOTOPROTECTIVE POTENTIAL OF  
ETHYLACETATE FRACTION FROM ETHANOLIC EXTRACT OF RED  
DRAGON FRUIT PEEL (*HYLOCERIUS POLYRHIZUS*)**

**Hari Widada<sup>a\*</sup>, Nurhasna Susmitha<sup>b</sup>**

<sup>a</sup>Universitas Muhammadiyah Yogyakarta, Jl. Lingkar Selatan, Yogyakarta 55183,  
Indonesia.

<sup>b</sup>Universitas Muhammadiyah Yogyakarta, Jl. Lingkar Selatan, Yogyakarta 55183,  
Indonesia.

**Abstract**

Free radicals can be caused by exposure of UV rays. High free radicals in the body can be a trigger of many diseases. Photoprotective agent can protect the skin from exposure of UV rays. In addition, antioxidant compound can also reduce a negative impact of free radicals. Red dragon fruit (*Hylocereus polyrhizus*) was one of the fruits which contain a flavonoid compound. This compound can act as photoprotective and antioxidant agents. This study aims to know the content of flavonoid in the peel of red dragon fruit (*Hylocereus polyrhizus*) and knowing the antioxidants and photoprotective activities. The peel of red dragon fruit (*Hylocereus polyrhizus*) extracted with ethanol then macerate and fractionated with ethylacetate. The content of phenolic and flavonoid compounds of ethylacetate fraction of the red dragon fruit peel (RDFP-AcOEt) tested with TLC method, Folin-Ciocalteu method, and AlCl<sub>3</sub> chelation method. Furthermore, the free radical (DPPH) scavenging test was to be done to find out the antioxidant activities from RDFP-AcOEt and *in vitro* test with spectrophotometry method was conducted to find out the SPF value of RDFP-AcOEt. The Total Phenolic Content of RDFP-AcOEt was  $1493.46 \pm 14.97$  mg GAE/100g and the Total Flavonoid Content of RDFP-AcOEt was  $16.53 \pm 0.36$  % b/b EQ. Antioxidant activities of RDFP-AcOEt was weak ( $> 150$  µg/mL). It was seen from the IC<sub>50</sub> value of RDFP-AcOEt ( $491.94$  µg/mL). Meanwhile, the SPF value of RDFP-AcOEt was very low ( $0.0069 \pm 0.0071$ ). So, the RDFP-AcOEt at a concentration of 5, 25, 50 and 100 mg/L does not have photoprotective activities.

**Keywords:** Antioxidant, Photoprotective, Ethylacetate, *Hylocereus polyrhizus*

**1. Introduction**

Sunlight is the largest source of energy for the earth and living creatures that live thereon. Direct benefits for humans is increasing the supply of vitamin D through exposure to UVB radiation (Ultraviolet B) (Mead, 2008). Besides the benefits, excessive sun exposure can lead to damage to the human body through a mechanism involving free radical compounds. High levels of free radicals in the body will produce oxidative

stress that can cause various diseases such as skin cancer, arthritis, aging, autoimmune disorders, cardiovascular and neurodegenerative diseases (Pham-Huy *et al*, 2008). *World Health Organization* (WHO) estimates that there will be an increase in the incidence about 300,000 cases of non-melanoma and 4,500 cases of melanoma skin cancer due to the depletion of the ozone layer (WHO, 2015).

Ultraviolet radiation can enter the skin through a chromophore or a particular molecule that can capture electromagnetic waves at specific wavelengths (Lucas, 2015). Sunscreen or a photoprotective agent can protect the skin from exposure to UV rays by absorbing, reflecting, as well as the spread (scatter) sunlight (Mishra *et al*, 2011). Chemical compounds contained in sunscreen are generally aromatic compounds conjugated with a carbonyl group (Rai *et al*, 2007). Flavonoids naturally occurring compounds that have the potential as a photoprotective agent because it has the ability to absorb UV light and can be an antioxidant agent (Saewan *et al*, 2013). Antioxidant compounds commonly used are vitamin E or  $\alpha$ -tocopherol, BHA, and BHT (Fessenden, 1986). Antioxidant compounds also found in fruits. One type of fruit or food that can be used as an antioxidant and photoprotective agent is a red dragon fruit (*Hylocereus polyrhizus*).

Red dragon fruit (*Hylocereus polyrhizus*) contains a variety of bioactive compounds such as stearic acid, oleic acid, campesterol, stigmasterol, acetic acid, betanin, isobetanin, phenolic and flavonoid (Foong *et al*, 2012). Several studies have been conducted to determine the antioxidant power of red dragon fruit peel. Budilaksono *et al*. (2014) ake non-polar compounds from the extracts which are semi-polar in the form of n-hexane fraction of chloroform extract that produce IC<sub>50</sub> value of 206.591 mg / mL. Quercetin is one of a class of flavonoids (flavonoids) that are semi-polar which have higher antioxidant activity than vitamin C with a ratio of 4.7: 1 (Sugrani *et al*, 2009). Therefore, this study would like to take compounds that are semipolar from the polar extract in the form of ethyl acetate fraction of ethanolic extract. It is expected that flavonoids like quercetin can be retrieved and can be tested the antioxidant and photoprotective potency to prevent excessive exposure to ultraviolet light.

## 2. Material and Methods

**2.1. Chemicals and Reagents.** Red dragon fruit (*Hylocereus polyrhizus*) was purchased from Banyuwangi, East Java, Indonesia. Ethanol 96%, ), Citroboric reagents (boric acid and citric acid), n-butanol, Folin-ciocalteu, Na<sub>2</sub>CO<sub>3</sub>, quercetin standard, Acetic acid, AlCl<sub>3</sub>, NaNO<sub>2</sub>, NaOH, DPPH by pro-analytical grade was purchased from E-Merck. The dry powder of red dragon fruit peel prepared using a blender (Philips®), and evaporation the extract using a rotary evaporator (IKA® RV10) and water bath (Mettler®). Absorbance measurements using UV-Vis Spectrophotometer Mini 1240 (Shimadzu®).

**2.2. Sample Preparation and Extraction.** The red dragon fruit peel (RDFP) (*Hylocereus polyrhizus*) separated by flesh because only the skin of the fruit is used as a sample. Thereafter, the RDFP was cut into small pieces ( $\pm$  5mm) and then dried with the help of sunlight in a state covered with black cloth. Subsequently was continued drying using the oven at a temperature of 50°C. The RDFP that has been dried mashed by means of a blender to obtain a dry powder of red dragon fruit peel. The dry powder of RDFP (*Hylocereus polyrhizus*) then macerated with ethanol 95% with a ratio of material: solvent (1:10) for 7 days (with 5 days maceration and 2 days for second maceration) at room temperature in a light-tight container. The extract solution is then filtered and concentrated using a rotary evaporator at 50°C continued with using a water bath at a temperature of 50°-70°C to obtain an ethanolic extract of RDFP (*Hylocereus polyrhizus*) (RDFP-EtOH). RDFP-EtOH was dissolved in a mixture of H<sub>2</sub>O-MeOH (3: 7). Furthermore, the liquid-liquid fractionation with ethylacetate (AcOEt) in order to obtain ethyl

acetate fraction from the ethanolic extract of red dragon fruit peel (RDFP-AcOEt). RDFP-AcOEt fraction is then concentrated using an electrical stove temperature of 50°C. Condensed fraction is used to perform various tests next.

**2.3. Total Flavonoids Content.** Total flavonoid content determined by means of chelation  $AlCl_3$ . A total of 0.4 mL fractions RDFP-AcOEt added with 0.6 mL of distilled water and 0.06 ml of  $NaNO_2$  (5%). The solution was incubated for 6 minutes at room temperature and then added with 0.06 mL of  $AlCl_3$  (10%), after 5 minutes and then added 0.4 mL  $NaOH$  (1 mM). Furthermore, the absorbance was measured at a wavelength of 510 nm using a UV-Vis spectrophotometer with replication is done 3 times (Saini *et al.*, 2011). The quercetin concentrations of 400, 800, 1200, 1600 and 2000  $\mu\text{g/mL}$  were tested as above procedure. The linear regression equation of quercetin was made of the relationship between the concentration and the absorbance value of quercetin. The regression equation used to calculate the levels of flavonoids in the sample.

**2.4. Total Phenolic Content.** Total phenolic content was tested using the Folin-Ciocalteu reagent, where about 400 mL RDFP-AcOEt fractions added by 3.16 mL of distilled water and 200 mL of Folin-Ciocalteu reagent, mixed until homogeneous. The solution is shaken out for 6 minutes. Furthermore, added 600 mL of 2%  $Na_2CO_3$  solution to form alkaline and homogenized by vortex (Talapessi *et al.*, 2013). The solution was allowed to stand at room temperature for 2 hours. Absorbance was observed at a wavelength of 760 nm using a UV-Vis spectrophotometer with replication is done 3 times. Gallic acid concentrations of 10, 20, 30, 40, and 50  $\mu\text{g/mL}$  were tested as above procedure. The Gallic acid linear regression equation was made of the relationship between the concentration and the absorbance value of gallic acid. The regression equation used to calculate the total phenol content.

**2.5. The Test of Antioxidant Potential with DPPH Method.** The fraction of RDFP-AcOEt (levels 100, 200, 300, 400 and 500  $\text{mg/mL}$ ) each mixed with 1 mL of DPPH (2,2-diphenyl-1-picrylhydrazyl) 0.4 mM dissolved in a solution of ethanol to 5 mL. The solution was allowed to stand to react at an ambient temperature in the dark for 30 minutes. The Absorbance of each solution is read at a wavelength of 518 nm using a UV-Vis spectrophotometer (Sumarny *et al.*, 2014). The replication carried out two times with each of its absorbances was measured 2 times. The percent (%) of Inhibition is calculated using the following formula:

$$\% \text{ inhibition} = \frac{(\text{Absorbance of control} - \text{Absorbance of sample})}{\text{Absorbance of control}} \times 100$$

The linear regression was made of the relationship between concentration and % inhibition. The regression used to calculate the  $IC_{50}$  value. Quercetin concentration of 1, 2, 3, 4, and 5  $\mu\text{g/mL}$  were tested as the procedure above to be used as the comparator.

**2.6. The determination of the Maximum Absorption Wavelength and the SPF value.** To define the maximum absorption wavelength ( $\lambda$ -max), a viscous RDFP-AcOEt fraction dissolved in absolute ethanol in order to obtain series of levels 5, 25, 50 and 100  $\text{mg/L}$ . Furthermore, the scanning by UV-Vis spectrophotometer at wavelengths between 260-400 nm with the intervals of 2 nm, by using ethanol as blank (Junior *et al.*, 2013). The maximum wavelength obtained subsequently adjusted for the value of  $EE \times I$ , which has been determined by Sayre *et al.* (1979) (Table 1). SPF value is calculated using a formula that has been developed by Mansur *et al.* (1986):

**Table 1.** Wavelength and  $EE (\lambda) \times I (\lambda)$  value (Junior *et al.*, 2013)

Wavelength (nm)	$EE \times I$
290	0.0150
295	0.0817



<b>300</b>	0.2874
<b>305</b>	0.3278
<b>310</b>	0.1864
<b>315</b>	0.0839
<b>320</b>	0.0180
Total	<b>1.0000</b>

$$\text{SPFSpectrophotometric} = \text{CF} \times \sum_{290-320} \text{EE}(\lambda) \times I(\lambda) \times \text{Abs}(\lambda)$$

Description:

- EE ( $\lambda$ ) : The erythema effects spectrum  
I ( $\lambda$ ) : The intensity of the sun's spectrum  
Abs ( $\lambda$ ) : Absorbance  
CF : Correction Factor (= 10)

### 3. Results and Discussion.

**3.1. Sample Preparation and Extraction.** The red dragon fruit peel (*Hylocereus polyrhizus*) in wet state obtained from 20 kg of whole red dragon fruit is as much as 7 kg. RDFP was cut into smaller sizes ( $\pm 5$  mm) to speed up the drying process. Drying continued with an oven at 50°C. The temperature that used is the temperature which does not damage the flavonoid compounds because of heating carried out at a temperature of 80°C can damage the flavonoid compound Chet (2009). Dried RDFP then extracted with 95% ethanol. The extraction using ethanol 95% will produce the highest antioxidant capacity with DPPH (656.52 mgTEAC/g) and phenolic levels greater (1.28 mgGAE/g) than using ethanol 50% and water (Chaiwut *et al*, 2012). The ratio of the powder by the solvent used was 1:10, which is the best ratio to obtain phenol, flavonoid content and best antioxidant activity (IC<sub>50</sub>) (Handayani *et al*, 2016). The viscous ethanolic extract of RDFP (*Hylocereus polyrhizus*) (RDFP-EtOH) obtained are about 19.273 grams. Subsequently, the viscous RDFP-EtOH extracts are used for liquid-liquid fractionation merely as much as 5,046 grams. Liquid-liquid fractionation performed to separate compounds that are polar and semi-polar in condensed RDFP-EtOH extract. Polar compounds (such betacyanin and anthocyanins) will be drawn into a solvent mixture of H<sub>2</sub>O-MeOH, whereas compounds that are semipolar (flavonoids such as flavones and flavonols) is attracted to the solvent ethyl acetate (AcOEt) (Indriasari, 2012; Budilaksono *et al*, 2014). The condensed fraction of RDFP-AcOEt is obtained as much as 2.886 gram. Therefore, the calculation resulting from the value of the yield of viscous fractions of RDFP-AcOEt against the dry skin dragon fruit is equal to 2.34%.

**3.2. Total Flavonoids Content.** Measurements of the total flavonoid RDFP-AcOEt fraction performed using AlCl<sub>3</sub> colorimetric methods (Zhinsen *et al*. 1999) that have been modified by Saini *et al*. (2011). The total flavonoid content of quercetin expressed in grams equivalents per 100 grams subfraction (% w / w EQ) (Rohman *et a.*, 2007). The reason for using quercetin as standard was because of quercetin is a flavonol group flavonoid that can form complexes with AlCl<sub>3</sub> (Desmiaty *et al*, 2009). Absorbance values and concentrations of quercetin are used for creating a linear regression equation. Quercetin linear regression equation obtained is  $y = 0.0009x - 0.1414$  with a  $R^2 = 0.9904$  (Figure 1).

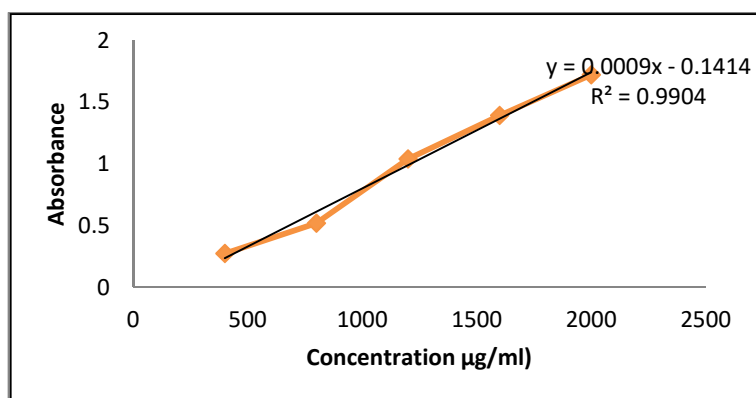

**Figure 1.** Standard curves of quercetin at total flavonoids test

If the absorbance value of the RDFP-AcOEt fraction put in the y-axis in the quercetin linear regression equation then the levels of flavonoids in the sample (x-axis) can be known. The result shows that the average levels of flavonoids in the sample RDFP-AcOEt fractions was  $171.89 \pm 3.76$  ppm. So that the levels of total flavonoids from RDFP-AcOEt fractions obtained from the calculation was  $16.53 \pm 0.36\%$  w/w EQ (Table 2). It means that every 100 grams of KBNM-AcOEt fractions equivalent to 16.53 grams of flavonoids quercetin. When compared with the research of Chet (2009), RDFP-AcOEt fractions showed higher levels of flavonoids than the water extracts of RDFP with an average grade of flavonoid about  $1.87 \pm 0.33$  mg catechin equivalents /25 g.

**Table 2.** Total Flavonoid Content in RDFP-AcOEt Fraction

Replication	Absorbance	Flavonoid Level in Sampel (ppm)	Total Flavonoid (%b/b EQ)
1	0.0154	174.22	16.75
2	0.0151	173.89	16.72
3	0.0094	167.56	16.11
<b>Average</b>		171.89	16.53
<b>Deviation Standard</b>		3.76	0.36

**3.3. Total Phenolic Content.** Total phenolic content of the RDFP-AcOEt fraction done using the Folin-Ciocalteu method. Gallic Acid Equivalent (GAE) is a common reference for measuring the amount of phenolic compounds present in a material. Usage of gallic acid was based on the availability of the substance is more stable and pure than the other standards compounds. The relationship between the absorbance values and the concentrations of gallic acid would produce a linear regression equation. Gallic acid linear regression equation obtained was  $y = 0,0105x + 0.0201$  with the value of  $R^2 = 0.9968$  (Figure 2). Total phenolic content of the RDFP-AcOEt fraction (x-axis) is calculated by entering the absorbance value of the sample of RDFP-AcOEt fractions into the y-axis. The result shows an average of total phenol content of the RDFP-AcOEt fraction (C value) was  $15.23 \pm 0.15$  mg GAE/mL. The dilution is not done in this test and the stock solution used was 25.5 mg RDFP-AcOEt fractions were dissolved in 25 mL ethanol. Therefore, the average of total phenolic content (TPC) of RDFP-AcOEt fractions obtained from the calculation was  $1493.46 \pm 14.97$  mg GAE/100g (Table 3). It means that every 100 grams of RDFP-AcOEt fractions equivalent to 1493.46 mg gallic acid. When compared with the research of Chet (2009), RDFP-AcOEt fractions showed total phenol content higher than RDFP water extracts with an average of total phenol content of  $2.7533 \pm 0.89$  mg GAE/25g.

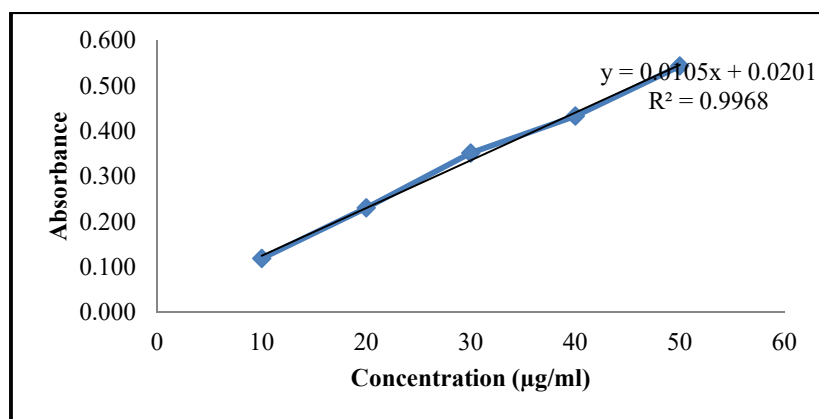

Figure 2. Standard curve of Gallic acid

Table 3. Total Phenolic Content of RDFP-AcOEt Fraction

Replication	Absorbance	Phenolic Level in Solution (µg GAE/mL sample)	Total Phenolic Content (mg GAE/100 g sample)
1	0.174	15.40	1509.80
2	0.171	15.10	1480.39
3	0.172	15.20	1490.19
Average		15.23	1493.46
Deviation Standard		0.15	14.97

**3.4. The Test of Antioxidant Potential with DPPH Method.** Antioxidant potential of phenolic and flavonoids compounds of RDFP-AcOEt fractions can be determined by performing a test of free radicals DPPH scavenging. Quercetin chosen for comparison because of quercetin has a very strong antioxidant activity. If vitamin C has antioxidant activity level is 1, then the quercetin has antioxidant activity level about 4.7 (Sugrani *et al*, 2009). The value of % inhibition obtained by calculation done by inputting absorbance values into the formula of % inhibition. The concentration of quercetin and RDFP-AcOEt fractions associated with the value of % inhibition would generate a linear regression. Quercetin linear regression obtained was  $y = 13,974x + 18.309$  by  $R^2 = 0.9954$ , whereas the linear regression equation RDFP-AcOEt fractions was  $0,0933x + y = 4.1018$  by  $R^2 = 0.9904$  (Figure 3). The linear regression equation was used to determine  $IC_{50}$  values (x-axis) by inputting a value of 50 in the y-axis to the linear regression equation obtained. The results showed that the  $IC_{50}$  value of quercetin was 2.268 µg/mL and the  $IC_{50}$  value of RDFP-AcOEt fractions was 491.942 µg/mL. It means that the RDFP-AcOEt fraction requires concentration of 491.942 µg/mL for DPPH radical capture as much as 50%, while the concentration of quercetin requires only 2.2679 µg/mL to capture as much as 50% DPPH radical. The large  $IC_{50}$  or smaller antioxidant power that allegedly caused flavonoid compounds that bind by side groups that can inhibit the activity of antioxidants, so that flavonoids can not donate hydrogen and electrons to the DPPH (Budilaksono *et al*, 2014). Additionally, the side groups also can cause methylated flavonoid (-H into -CH<sub>3</sub> group), so that the source of protons to capture DPPH reduced (Mikamo *et al*, 2000). The presence of other compounds such as proteins and fats in KBNM-AcOEt fractions allegedly also can interfere with the reaction of free radicals DPPH scavenging (Budilaksono *et al*, 2014). Although the  $IC_{50}$  value of the fraction into the weaker level, when seen from the level of

antioxidant activity according to Ariyanto (2006) ( $> 150 \mu\text{g/mL}$ ),  $\text{IC}_{50}$  value of 200-1000  $\mu\text{g/mL}$  otherwise still potential as an antioxidant (Molyneux, 2004).

**Table 4.** The average value of % inhibition of quercetin and RDFP-AcOEt fractions against the DPPH radical

Sample	Concentration ( $\mu\text{g/mL}$ )	Average of % inhibition
Quercetin	1	31.132
	2	46.275
	3	61.829
	4	75.568
	5	86.357
RDFP-AcOEt Fraction	100	13.701
	200	23.455
	300	29.748
	400	42.963
	500	50,601

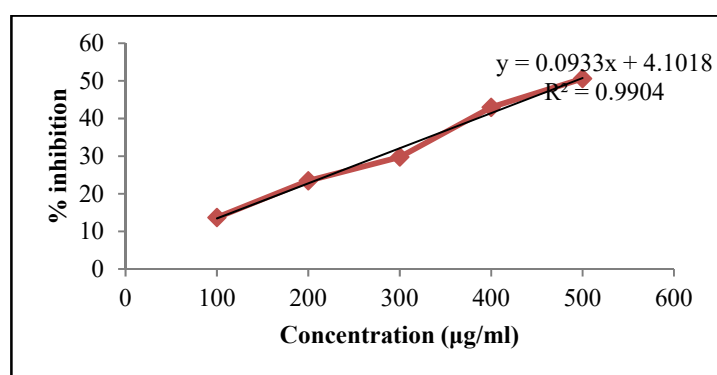

**Figure 3.** The linear regression equation of RDFP-AcOEt Fraction

### 3.5. Measurement of Maximum Wavelength and SPF (Sun Protection Factor)

**value.** Measurement of in vitro SPF value is done by determining the wavelength of maximum absorption ( $\lambda\text{-max}$ ) by spectrophotometric method. UV-Vis spectrophotometer scanning performed at wavelengths between 260-400 nm to determine the maximum wavelength of RDFP-AcOEt fractions at each concentration into the range of UVA, UVB or UVC. The maximum wavelength KBNM-AcOEt fractions at concentrations of 5, 25, and 50  $\mu\text{g/mL}$  known to reside in the UVB range area (290-320 nm), while the maximum wavelength KBNM-AcOEt fractions at a concentration of 100  $\mu\text{g/mL}$  in the UVC range region (200-290 nm) (Table 5). The concentration of RDFP-AcOEt fractions which were in the UVB range can be calculated the SPF value using a formula that has been developed by Mansur *et al.* (1986). While the concentration of RDFP-AcOEt fractions which were in the UVC range is not necessary SPF value calculation because the UVC rays are radiation which is not up to the earth's surface being absorbed by the ozone layer (McKinlay, 1987). The average value of the SPF in the UVB area of RDFP-AcOEt fraction was  $0.0069 \pm 0.0071$ . According to Wasitaadmatdja (1997), the minimum SPF value of a sunscreen or photoprotective agent is at least 2. Therefore, it can be said that the RDFP-AcOEt fraction concentration of 5, 25, 50 and 100  $\text{mg/L}$  does not have photoprotective potential. The low value of SPF on RDFP-AcOEt fraction ( $<2$ ) suspected to be caused by the concentration of RDFP-AcOEt fractions used is too

low. According to Widyastuti *et al.* (2015), the concentration of ethanolic extract of super red dragon fruit peel (*Hylocereus costaricensis* (FAC Weber) Britton & Rose) demonstrated effectiveness either as a sunscreen at a concentration of 900 ppm with SPF value of 22.438, while at a concentration of 100 ppm of ethanolic extract of super red dragon fruit peel does not show its effectiveness as sunscreen since the SPF value of less than 2 or equal 1.419.

**Table 5.** The scanning of Maximum Wavelength of RDFP-AcOEt Fraction

Concentration ( $\mu\text{g/mL}$ )	The maximum Wavelength (nm)	Absorbance	Ultraviolet Area
5	314	0.001	B
25	294	0.018	B
50	292	0.034	B
100	262	0.211	C

### Conclusion

Ethylacetate fraction of an ethanolic extract of red dragon fruit peel (RDFP-AcOEt) containing flavonoids at  $16.53 \pm 0.36\%$  w/w EQ is measured by the  $\text{AlCl}_3$  chelation method and total phenolic content of  $1493.46 \pm 14.97$  mg GAE/100 g which measured by the Folin-Ciocalteu method. Antioxidant potential of RDFP-AcOEt fractions is weak by the  $\text{IC}_{50}$  value that is equal to  $491.94 \mu\text{g/mL}$  measured by DPPH method. SPF value KBNM-AcOEt fraction was  $0.0069 \pm 0.0071$ . This indicates KBNM-AcOEt fraction concentration of 5, 25, 50 and 100 mg/L were tested using in vitro methods (spectrophotometry) does not have significant photoprotective potential.

### Acknowledgements

We thank Institute of Research, Publications and Community Service of Universitas Muhammadiyah Yogyakarta for financial support through the Tridharma enhancement grant 2015-2016.

### References

- Abdul Rohman, Riyanto, S., & Hidayati, N., (2007), Antioxidant Activity, Total Phenolic Content and Leaf Total Flavonoids Noni (*Morinda citrifolia* L), [Aktivitas Antioksidan, Kandungan Fenolik Total, dan Flavonoid Total Daun Mengkudu (*Morinda citrifolia* L)], *Agritech*, Vol.27 No.4.
- Budilaksono, W., Wahdaningsih, S., & Fahrurroji, A., (2014), Antioxidant Activity Test of N-Hexane fraction Red Dragon Fruit Peel (*Hylocereus lemairei* Britton and Rose) Method Using DPPH (1,1 - Diphenyl - 2 - picrylhydrazyl), *Journal of Pharmacy Students Faculty of Medicine UNTAN*, [Uji Aktivitas Antioksidan Fraksi N-Heksana Kulit Buah Naga Merah (*Hylocereus lemairei* Britton dan Rose) Menggunakan Metode DPPH (1,1 - Difenil - 2 - Pikrilhidrazil), *Jurnal Mahasiswa Farmasi Fakultas Kedokteran UNTA*]N, vol.1 no.1.
- Chaiwut, P., O-ki-la, A., Phuttisatien, I., Thitilertdecha, N., Pintathong, P., (2012), Extraction and Stability of Cosmetic Bioactive Compounds from Dragon Fruit Peel, *Conference*, School of Cosmetic Science Mae Fah Luang University, Thailand.
- Chet, N.W., (2009), Total Phenolic and Total Flavonoids Content of Pitaya Peels by Water Extraction, *Thesis*, Faculty of Chemical and Natural Resources Engineering, Universiti Malaysia Pahang.
- Desmiaty, Y., Ratnawati, J., Andini, P., (2009), penentuan Jumlah Flavonoid Total Ekstrak Etanol Daun Buah Merah (*Pandanus Conoideus* Lamk) Secara Kolorimetri

- Komplementer, *Presentasi Seminar Nasional POKJANAS TOI XXXVI*, Universitas Sanata Dharma.
- Fessenden, R.J. & Fessenden, J.S., (1986), *Organic Chemistry, Third Edition Volume 1. Translation [Kimia Organik, Jilid 1. Edisi Ketiga Terjemahan] Aloysius Hadyana Pudjaatmaka Ph.D*, Erlangga, Jakarta.
- Foong, J.H., Hon, W.M., & Ho, C.W., (2012), Bioactive Compounds Determination In Fermented Liquid Dragon Fruit (*Hylocereus Polyrhizus*), *Borneo Science*, volume 31.
- Handayani, H., Sriherfyna, F.H., Yunianta, (2016), Extraction of Antioxidants Sirsak Leaf Method of Ultrasonic Bath (Ratio Study Materials: Solvent Extraction and Old), *Journal of Food and Agro-Industry [Ekstraksi Antioksidan Daun Sirsak Metode Ultrasonic Bath (Kajian Rasio Bahan: Pelarut dan Lama Ekstraksi)]*, *Jurnal Pangan dan Agroindustri*, vol.4 no.1 p.262-272.
- Harborne, J., (1987), *Phytochemical methods: The Modern Guide How to Analyze Plant, Second printing, Translators [Metode Fitokimia: Penuntun Cara Modern Menganalisis Tumbuhan, Cetakan kedua, Penerjemah]: Padmawinata, K. Dan I. Soediro, ITB, Bandung.*
- Indriasari, I., (2012), Ethanol extracts of the Red Dragon Fruit (*Hylocereus polyrhizus*) Improve Lipid Profile in male Wistar rats (*Rattus norvegicus*) Dyslipidemia, Thesis, Master Program in Biomedical Science of Graduate Program, [Ekstrak Ethanol Buah Naga Merah (*Hylocereus Polyrhizus*) Memperbaiki Profil Lipid pada Tikus Wistar Jantan (*Rattus Norvegicus*) Dislipidemia, *Tesis*, Program Magister Program Studi Ilmu Biomedik Program Pascasarjana], Universitas Udayana Denpasar.
- Junior, R.G.O., Araujo, C.S., Souza, G.R., Guimaraes, A.L., Oliveira, A.P., Lima- Saraiva, S.R.G., Morais, A.C.S., Santos, J.S.R., & Silva, A.J.R.G., (2013), In Vitro Antioxidant and Photoprotective Activities of Dried Extracts from *Neoglaziovia variegata* (Bromeliaceae), *Journal of Applied Pharmaceutical Science*, Vol. 3 (01), pp. 122-127.
- Lucas, R.M., Norval, M., Neale, R.E., Young, A.R., de Gruijl, F.R., Takizawa, Y., & van der Leun, J.C., 2015, The Consequences for Human Health of Stratospheric Ozone Depletion in Association with Other Environmental Factors, *Photochem. Photobiol. Sci.*, 14, 53–87.
- Mansur, J.S., Breder, M.V.R., Mansur, M.C.A., Azulay, R.D., (1986), Determinação do fator de proteção solar por espectrofotometria. *An Bras Dermatol*, 61:121-124.
- McKinlay, A., & Diffey, B.L., (1987), A Reference Action Spectrum for Ultraviolet Induced Erythema in Human Skin: In Human Exposure to Ultraviolet Radiation, Risks and Regulations, *Elsevier*, Amsterdam, Netherlands, p 83.
- Mead, M.N., (2008), Benefits of Sunlight: A Bright Spot for Human Health, *Environmental Health Perspectives*, 116(4): A160–A167.
- Mikamo, E., Okada, Y., Semma, M., Itto, Y., Morimoto, T., (2000), Studies on Structural Correlation with Antioxidant Activity of Flavonoids, *J. Jpn. Soc. Food Sci. Technol.* 7:97-101.
- Mishra, A.K., Mishra, A., & Chattopadhyay, P., (2011), Herbal Cosmeceuticals for Photoprotection from Ultraviolet B Radiation: A Review, *Tropical Journal of Pharmaceutical Research*; 10 (3): 351-360.
- Molyneux, P., (2004), The Use of The Stable Free Radical Diphenyl picrylhydrazyl (DPPH) for Estimating Antioxidant Activity, *Songklanakarinn J. Sci. Technol*, 26 (2):211-219.
- Pham-Huy, L.A., He, H., & Pham-Huyc, C., (2008), Free Radical, Antioxidant in Disease and Health. *Int.J. Biomed. Sci.* 4(2):89-96.
- Rai, R., & Srinivas, C.R., (2007), Photoprotection., *Indian dermatol venerol lepro*, vol.73, issue 2.

- Saewan, N., & Jimtaisong, A., (2013), Photoprotection of Natural Flavonoids, *Journal of applied pharmaceutical scienc*, vol.3 (09).
- Saini, N.K., Singhal, M., Srivastava, B., (2011), Evaluation of Antioxidant Activity of *Tecomaria capensis* Leaves Extract, *Ethnopharmacology*, Vol. 2011, Issue 2.
- Sayre, R.M., Agin, P.P., Levee, G.J., Marlowe, E., (1979), Comparison of In Vivo and In Vitro Testing of Sunscreening Formulas, *Photochem Photobiol*, 29:559-566.
- Sugrani, A., & Waji, R.A., (2009), Flavonoids (quercetin), Papers, Faculty of Mathematics and Natural Sciences [Flavonoid (Quercetin), *Makalah*, Fakultas Matematika dan Ilmu Pengetahuan Alam], Universitas Hasanuddin.
- Sumarny, R., Sofiah, S., Nurhidayati, L., Fatimah., (2014), Antioxidant activity of Mangosteen (*Garcinia mangostana* L.) Fruit Rind Extract in Oral Solution Dosage Form, *Presentation*, International Symposium on Medicinal Plants & Traditional Medicine.
- Talapessy, S., Suryanto, E., Yudistira, A., (2013), Antioxidant Activity Test of Dregs results Sago Processing (Metroxylon sago Rottb), *Journal of Pharmaceutical Science* [Uji Aktivitas Antioksidan dari Ampas Hasil Pengolahan Sagu (*Metroxylon sago* Rottb), *Jurnal Ilmiah Farmasi*] - UNSRAT, vol.2 no.03.
- Wasitaatmaja, S.M., (1997), The Guidance for Medical Cosmetic Sciences [*Penuntun Ilmu Kosmetik Medik*], UI Press, Jakarta.
- WHO, (2015), Protection Against Exposure to Ultraviolet Radiation, *Publication*, Diakses 10 Mei 2015 pukul 11.57 WIB, dari <http://www.who.int/uv/publications/proUVrad.pdf>.
- Zhinshen, J., Tang, M., & Wu, J., (1999), The Determination of Flavonoid Content in Mulberry and Their Scavenging Effect on Superoxide Radicals, *Food Chemistry*, 64 555-559.

---

**Effectiveness of Wound Cleansing Using Guava Leaves 20%  
Infusion with Showering Technique 15 Psi Pressure toward the  
number of bacteria on Diabetic Foot Ulcer at Kitamura Clinic,  
Pontianak**

**Jaka Pradika<sup>a</sup>, Yoni Astuti<sup>b\*</sup>, Novita Kurnia Sari**

<sup>a</sup> Student of Master of Nursing Postgraduate Programme , Universitas Muhammadiyah Yogyakarta, jalan Lingkar Selatan, Tamantirto, Kasihan, Bantul, DIY, Indonesia. 55183

<sup>b</sup> Master of Nursing Postgraduate Programme , Universitas Muhammadiyah Yogyakarta, jalan Lingkar Selatan, Tamantirto, Kasihan, Bantul, DIY, Indonesia. 55183

---

**Abstract**

Wound cleansing is required to reduce the prevalence of Diabetic Foot Ulcer (DFU). Guava leaves infusion has a lot of substances that able to reduce the bacteria. This study to determine the effect of wound cleansing using guava leaves 20% infusion with showering techniques 15 Psi toward the number of bacteria on wound of DFU. This study used quasi experimental. Sixty six respondents were divided into the infusion of guava leaves 20% group (1), NaCl 0.9% group (2) and ozone water group (3). Each group was performed cleansing wounds using the showering technique with 15 Psi. The sampling technique used was consecutive sampling to count the number of bacteria on DFU. Bacteria collecting used swab method on 4 areas. To count the number of bacteria used bacteria counter machine. Data was analysed by one way anova. The average of responden age (years old) were  $54.45 \pm 4.758$  (1),  $52.09 \pm 4.638$  (2), and  $54.23 \pm 4.937$  (3). The average of bacteria number were  $(4.52 \pm 2.66) \cdot 10^7$  (1),  $(4.06 \pm 2.78) \cdot 10^7$ , and  $(11.7 \pm 2.38) \cdot 10^7$ . There were significant difference of reducing the number of bacteria using NaCl ( $p=0.004$ ), 20 % guava leaf infusion ( $p=0.010$ ) and ozone ( $p = 0,018$ ). The most effective was 20 % guava leaf infusion. The guava leaves infusion showed the most significant results in lowering number of bacteria on DFU.

**Keywords:** Diabetic foot ulcers, Wound cleansing, Showering Technique, Infusion of guava leaves 20%, number of bacteria

---

**1. Introduction**

Diabetic Foot Ulcer (DFU) was an effect of complication on cronic diabetic mellitus and as the main cause of morbidity, mortality and defect of the patient with diabetic. The main cause of DFU was neurophaty (sensoric, motoric and deficit of otonom), and ischemic or both (neuro-ischemic) (arwani, at al, 2014; Benbow and Steven, 2010)

The insidenci and mortality of DFU is always increase, due to the serious health problems that need well management. The good wound management consists of cleansing, debridement and dressing were some ways to reduce mortality cause of DFU.

*Wound Cleansing* is the first step to cure the wound that maintain the wound cleanliness, release the debris, to minimize of bacterial number and to facilitate wound



recovery (Yusuf, et al, 2011). Wound *Cleansing* consist of the methods how to spread solution and the kind of solution for cleansing. The easiest and the effective cleansing technic is showering meanwhile for the solution used to NaCl 0.9%. The solution NaCl 0,9% was physiologic solution, it was not irritate and un toxic to tissue but NaCl 0.9%. did not has antibacterial effect. NaCl 0.9%. were not the best solution for DFU with infection (Atiyah, et al,2009).

Kitamura Pontianak is the clinic to cure the DFU, using showering technic to clean the DFU but there was not measurable standart pressure and used NaCl 0.9% as cleaning solution. This study conducted to addresses the showering technic with 15 psi as an optimum pressure on DFU and to explore an alternative solution contain antibacterial to the bacterial number on DFU. This study use guava leaves infusion 20 %. Guava leaves contains anti microbial, anti inflammation, and analgesic ( Baronski and Ayello, 2003).

### Research Methods

This research was an experimental research. There were 66 patients with DFU at Kitamura clinic. This research consists of 3 groups, groups 1 treated with guava leaves infusion 20 % (22 patient), group 2 treated with ozone (as positive groups. 22 patients) and groups 3 treated with the NaCl 0.095 % (as negative groups, 22 patient). Wound cleansing is conducted one times per 2 days. The bacteria was swabbed 4 areas on the wound. And the bacteria number measured with bacteria counter machine.

The Data were analysed using one way annova.

### Result and Discussion

#### 1. The characteristic of subject

Characteristic of subject	Group 1 (N)	Group 2 (N)	Group 3 (N)	Total
Sex				
Male	11	9	10	30
Female	11	13	12	36
Smoking history				
Yes	4	8	8	20
No	18	14	14	46

Group 1: Guava infusion treatment

Group 2; ozone treatment

Group 3: NaCl treatment

The characteristic of subject was listed in table 1. Female was bigger number than male. Women has estrogen much more than man and monthly has hormone cyclus . The unstable hormon could induce high risk of wound. The incidence of DFU higher on the menopause women . Degeneration of estrogen induce neurophaty (Hardman and ashcft,2008). Eestrogen fasilitate respond of inflamation, maintain lipid and cholesterol, manage insulin and regulate apoptoiss stem cell that determine cell life and tissue growth during wounded .

Most of subject were not smoking (70 %). Smoking was one of the risks that inhibited recovery process but the exact mechanisme of smoking patophysiology was not determine yet. Thought the free radical from the tobacco or smoke was contribute to the worse wounded.

## 2. Age and Blood glucose

### 2.1. Age

The average of age and blood glucose on each groups was listed on table 2. The average of age on groups 1 was (54.45±4.758) years, groups 2 was (52.09±4.638) years and groups 3 (54.23±4.937) years. All subject were elderly. There were not significant different between the groups ( $p > 0.05$ ). People in age more than 45 y.o entrance to the DM risk (Anonim,2007). The Age is one of the factors influenced the health progressing. During the degerative process cell and organ has decreasing functional. On this age, the appetite was decrease, result on low nutrision, rest time was decrease, and stress effect of wound increase, and the capability to wound self curing was decrease.

Blood sirculation, oxygen distribution to the wound, blood clotting, inflammation respond, and fagocytosis were damaged at the aging process due to high risk for infection during the wound curing (Mogford,et al,2008 a; anonym,2009).

Table 2. The average of age and blood glucose on the groups

Variabel	Group 1	Group 2	Group 3	P value
	Mean±SD	Mean±SD	Mean±SD	
Age ( years)	54.45±4.758	52.09±4.638	54.23±4.937	P>0.05
Blood glucose(gr/dl)	156.09±74.172	173.23± 73.439	188.14±72.509	P>0.05

Group 1: Guava infusion treatment

Group 2: ozone treatment

Group 3: NaCl treatment

### 2.2. Blood Glucose

The average of blood glucose at all the groups were around 140-<200 mg/dl. The increasing of blood glucose along time and unwell treated will increase the blood viscosity and cause the decreasing of oxygen and some important nutrients that needed by the wound tissue (LeMone and Burke,2008). The decreasing of blood flow and oxygen supply to the neuron was a acause the neuropathy (Sukarni,2015).

The high blood glucose on the subject were influenced by some factor that we did not control well, such as, diet, medicine, stress. The diet was depend on the family menu. There werenot certain menu for the patient.The expense for wound managemen and check blood glucose were expensive for them induce some stresses.

## 3.The bacteria number

Table 3. The average of bacterial number on the groups

Variabel	Group 1	Group 2	Group 3	P value
	Mean±SD	Mean±SD	Mean±SD	
Bacteria number (per cm2)	(4.52 ± 2.66).10 <sup>7</sup>	(4.06 ± 2.78).10 <sup>7</sup>	(11.7 ±2.38) .10 <sup>7</sup>	P <0.05

Group 1: Guava infusion treatment

Group 2; ozone treatment

Group 3: NaCl treatment

The average bacterial number on group 1 was (4.52 ± 2.66) .10<sup>7</sup>, groups 2 was (4.06 ± 2.78).10<sup>7</sup> and groups 3 was (11.7±2.38).10<sup>7</sup>, the p value < 0,05. There was significant

different between guava infusion treatment and NaCl treatment, also ozon treatment and NaCl treatment. There was not significant between Guava treatment and Ozone treatment  $p>0.05$ .

The average of bacterial number more than  $10^5$ , this meant an infection on the wound of FDU (Benbow and Steven,2010). The infection was caused by the low immunity, micro and macro angiopathy due to lack wound tissue perfusion. This result on prolong of inflammation and disturb epitheliazation, contraction and collagen deposit. Beside ischemic result in lower circulation induce the vascular damage result in decreasing to against the infection agent.

Ozone solution able to oxidize many kind of bacteria, fungus, spore, yeast, and other organic substance. The effect of ozone solution to bacteria, was disturbing the capsule of bacteria by oxidising phospholipid and lipoprotein, then penetrate to inner membrane, to change the structure of DNA result in closed DNA due to inhibit the proliferation of bacteria, disturbing some bacteria metabolism.

Beside ozone improve oxygen distribution and release growth factor that needed to reduce ischemia and increase the wound recovery (Dewiyanti et al,2009). The increasing of bacterial number reflected the cleanliness level of the wound. Wound dressings sometimes was wet and unclean . The high moist dressing was a good media for bacteria to grow. Treatment using guava infusion 20 % were decreasing the bacterial number , almost the same effect to the positive control group ( Ozone treatment). Ozone was a strong oxidant after flour, and could kill some bacterias by breaking bacteria protein chain. Ozon was used to kill virus and bacteria in event air and watering media. Ozone is used as cleaning solution via ozonaizer machine but it was expensive (Usada and Purwadi,2007).

Picture 1. The average of bacterial number on the groups

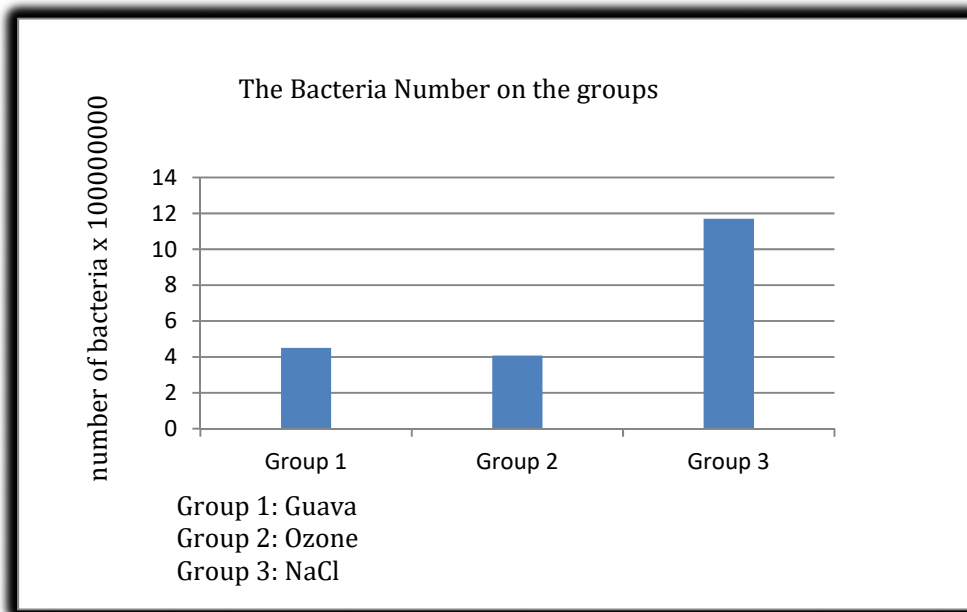

Picture 1 showed that Guava 20% infusion almost have the similar effect with ozone solution to clean the wound. Guava infusion 20 % have the significant effect caused by natural antimicrobial in it. The antimicrobial inhibited bacterial gram positive growth by breaking cell membrane. Guava infusion contain some beneficial substances such as flavonoid, tanin, alcaloid, glucosida, saponin and steroid/terpen.

Based on in vitro research guava infusion able to inhibit the growth of some bacteria that found on the DFU wound such as *Staphylococcus aureus*, *Streptococcus mutans*,

*Pseudomonas aeruginosa, Salmonella enteritidis, Bacillus cereus, Proteus spp., Shigella spp. and Escherichia coli.*

## Conclusion

The guava leaves infusion 20% as an potential alternative cleaning solution for curing the DFU wound. The guava leaves 20% has similar effect to reduce the bacterial number with ozone solution.

## References

1. Arwani., Siswanto, P., & Sugijana, R.(2014). Perbedaan tingkat perfusi perifer ulkus kaki diabetik sebelum dan sesudah olahraga pernafasan dalam di ruang wijaya kusuma rsud dr. R. Soeprapto cepu. In prosiding seminar nasional (vol. 2, no. 1
2. Atiyeh, B.S., Dibo, S.A. and Hayek, S.N. (2009). Wound cleansing, topical antiseptics and wound healing. *International wound journal*, 6(6), pp.420-430.
3. Baranoski, S., & Ayello, E., A. (2003). *Wound Care Essentials : Practice Principles*. United States of America : Lippincott Williams & Wilkins.
4. Benbow, M. and Stevens, J.(2010). Exudate, infection and patient quality of life. *British Journal of Nursing*. 19(20), p.30.
5. Departemen Kesehatan RI. (2007). *Rises Kesehatan Dasar (Risesdas) 2007*. Jakarta: Laporan Nasional.
6. Dewiyanti, A., Ratnawati, H., dan Puradisastra, S. (2009). Perbandingan Pengaruh Ozon, Getah Jarak Cina (*Jatropha Multifida L.*) dan Povidone Iodine 10% terhadap Waktu Penyembuhan Luka pada Mencit Betina Galur Swiss Webster . Bandung: Universitas Kristen Maranatha.
7. Handayani, T. N. (2010). Pengaruh Penegelolaan Depresi Dengan Latihan Pernafasan Yoga (Pranayama) Terhadap Perkembangan Proses Penyembuhan Ulkus Kaki Diabetikum Di Rumah Sakit Pemerintah Aceh. Tesis. Jakarta: Universitas Indonesia.
8. Hardman, M.J. and Ashcroft, G.S. (2008). Estrogen, not intrinsic aging, is the major regulator of delayed human wound healing in the elderly. *Genome biology*, 9(5), p.1.
9. LeMone, P & Burke, R. (2008), *Medical surgical nursing critical thinking in client care (4th.ed)*, Upper Sadle River-New Jersey, Pearson Prentice Hall.
10. Mogford, J.E., Sisco, M., Bonomo, S.R., Robinson, A.M. and Mustoe, T.A.(2008). Impact of aging on gene expression in a rat model of ischemic cutaneous wound healing. *Journal of Surgical Research*, 118(2), pp.190-196.
11. PERKENI (2009). *Pedoman Penatalaksanaan Kaki Diabetik*. Jakarta: Perkeni.
12. Sukarni. (2015). Efektivitas muscle stimulator terhadap penyembuhan luka di Klinik Kitamura Pontianak. *Tesis*. Bandung: Universitas Padjajaran.
13. Usada, W. and Purwadi, A. ( 2007). *Prinsip Dasar Teknologi Oksidasi Maju: Teknologi Hibrida Ozon Dengan Titania*. Ganendra IPTEK Nuklir, 10(2).

14. Yusuf, S., Okuwa, M., Shigeta, Y., Dai, M., Iuchi, T., Rahman, S., & Sanada, H. (2011). Microclimate and development of pressure ulcers and superficial skin changes. *International wound journal*, *12*(1), 40-46.

---

**RELATIONSHIP BETWEEN URIC ACID LEVELS AND RISK FACTOR  
IN HYPERTENSIVE PATIENT**

Ika Setyawati<sup>a</sup>, Syarif Maulana<sup>b</sup>

*<sup>a</sup>Department of Biochemistry, Faculty of Medicine and Health Science,  
Universitas Muhammadiyah Yogyakarta*

*<sup>b</sup>Student of Medical and Health Science Faculty of Universitas Muhammadiyah  
Yogyakarta*

---

**Abstract**

Background: Hypertension is a major health problem in both the developed and developing countries. The prevalence of hypertension in Indonesia according to the basic health research in 2013 was 25,8% while the prevalence in Yogyakarta was 25,7%. Hypertension is a risk factor of myocardial infarct and CVA (cerebrovascular accidents). Cardiovascular disease is the leading cause of death worldwide.

Method: This research was an analytic observational study with cross sectional approach. It has been conducted at PKU Muhammadiyah Hospital of Gamping from March - 24 March 2016. Subjects were obtained using total sampling method. The researcher used medical records to determine the uric acid level and blood pressure. There were 41 samples that were analyzed in this study.

Result: This study shows (1) there is no significant impact between uric acid levels towards systolic blood pressure ( $p=0.817$ ) and uric acid levels towards diastolic blood pressure ( $p= 0.274$ ), (2) the systole and diastole blood pressure has a positive correlation with the uric acid levels, the systole has a very weak correlation ( $r=0.037$ ) and so does the diastole ( $r=0.175$ ).

Conclusion: There is no relationship between uric acid levels and risk factor in hypertensive patient.

**Keywords**

*Keywords: Uric acid levels; hyperuricemia; blood pressure; hypertension.*

---

\* Corresponding author. Tel.: +6281392201984; fax: +62274387646  
E-mail address: ikasetyawati.dr@umy.ac.id

## 1. Introduction

Hypertension is a major health problem in both the developed and developing countries. According to the survey that is conducted by World Health Organization (WHO) in 2010, approximately 40% of population aged over 25 years old are diagnosed with hypertension.

According to the result of basic health research conducted by Research and Development Ministry of Health Republic of Indonesia (Rikesdas) in 2013, approximately 25,8% population aged over 18 years old are diagnosed with hypertension. According to the WHO in 2014, of 56 million deaths worldwide, about 38 million (68%) are due to four Non-Communicable Diseases, which are: cardiovascular disease, cancer, diabetes, and chronic pulmonary disease. Cardiovascular disease is the leading cause of death worldwide of 17,5 million (46%).

Hypertension is a disease that nowadays is more common to be found in Indonesia, especially in big cities. Hypertension has a direct risk factor to myocardial infarct and CVA (cerebrovascular accidents) (Tambayong, 2000). The hypertension is hard to be cured but it can be controlled to a normal range (Sidabuntar et al, 1991).

Hypertension is a condition where the systolic blood pressure  $\geq 140$  mmHg and diastolic blood pressure  $\geq 90$  mmHg (Sidabuntar et al, 1991). The measurement scale is nominal. Results categories are hypertension and normotensive. Blood pressure measurement is done by using spigmomanometer cuff wrapped around correspondent's upper arm, the stethoscope is placed over the brachial artery just bellow the cuff's edge. While listening with the sthetoscope, inflate the cuff until the heart sound is disappear and then inflate again at about 30 mmHg more and then release air from the cuff at a moderate rate. The first knocking sound is the systolic pressure and when the knocking sound disappears, that is the diastolic pressure (Muttaqin, 2009).

The uric acid levels is level of uric acid in a serum. The normal rate of uric acid levels for male is 7,0 and below whereas for female is 6,0 mg/dL and below. The measurement scale is nominal. Results categories are hyperuricemia and normal (Chernecky, C & Berger, B., 2012).

## 2. Material and Methods

This research was an analytic observational study with cross sectional approach. This research aimed to study the dynamics of relationship or correlation between risk factor and its impact. The researcher used medical records to determine the uric acid level and blood pressure. There were 41 samples that are analyzed in this study.

Inclusion criteria in this study are in patients in RS PKU Muhammadiyah Gamping from the period of January 2014 - December 2015, both males and females aged 30-90 years that are suffering from hypertension and had been conducted the uric acid measurement. Whereas the exclusion criteria are pregnant women, diabetes patients, and renal failure patients.

Data collection was obtained from medical records in RS PKU Muhammadiyah Gamping. Data retrieved from medical records include patients identity, blood pressure measurement, uric acid levels, and patients history.

## 3. Result and Discussion

### 1.1 Study Sample Characteristic

This study has been conducted in RS PKU Muhammadiyah Gamping from 8 March - 24 March 2016. Samples used in this study were obtained as a secondary data from medical records from the period of January 2014 - December 2015. Using total sampling method, there were 41 subjects that are suffered from hypertension consist of

20 males and 21 females. Out of 41 subjects, 11 subjects were having hyperuricemia and 30 others were normal. Subject characteristic can be seen further as followed.

**Table 1.** Sample Distribution Based on Age in Hypertensive Patients

Age	Number	Percentage
< 40 y.o	3	7.32 %
40-60 y.o	14	34.14 %
≥ 60 y.o	24	58.54 %
Total	41	100 %

Table 1 shows the prevalence of hypertensive patients increases with age. This sample study shows that hypertensive patients mostly in the age group ≥ 60 years.

Table 1 shows the distribution of hypertensive patients according to age group. Ages has main role in hypertension prevalence. The risk for hypertension increase with age (Rahajeng E, Tuminah S, 2009). This result is consistent with the result from basic health research conducted by Research and Development Minsitry of health Republic of Indonesia in 2013 that declared that prevalence of hypertension based on measurement by paramedics is increased with age.

**Table 2** Sample Distribution Based on Sex and Uric Acid Levels

Sex	<i>Normouricemia</i>	Percentage	<i>hyperuricemia</i>	Percentage
Male	11	55.00%	9	45.00%
Female	19	90.48%	2	9.52%

Table 2 shows that the percentage of patients with hyperuricemia is higher in male with the number of 55,00% compared to the female which is only 9.52 %

Table 2 shows percentage of hypertensive patients that also has hyperuricemia is higher in male group compared to the female group. The same results also can be found in a research done by Rahman in Ain Shams University Hospital in 2014. Uric acid levels are higher in men because it tends to increase along with age.

Women have estrogen that helps the excretion of uric acid trough urine so that the uric acid levels in women begin to increase when they have menopause (Igrisa,V.J, 2015). The relationship between high uric acid levels with age is due to change of renal function that unable to remove uric acid adequately.

### 1.2 *The Effect of Uric Acid Levels Towards Hypertension*

The result of uric acid levels and blood pressure measurement obtained from correspondents were then processed using SPSS. Simple linear regression test was used in this study to determine the relationship between uric acid levels and hypertension. To perform the normality test this study used Shphiro-Wilk statistic test because the samples in this study are less than 50, which were only 41 samples obtained.

After normality test was conducted, simple linear regression test was used to predict the impact of independent variable towards the dependent variable. The impact can be seen by comparing significanr value with probability value (0.05) and also the number of coefficient regression (b). The independent variable in this study is uric acid levels whereas the dependent value is hypertension (systole and diastole blood pressure).



**Table 3** The result of Simple Linear Regression test. The relationship Between Uric Acid Levels and Blood Pressure (SBP and DBP).

Variable	<i>p</i>	<i>b</i>
TDS	0.907	0.168
TDD	0.108	1.376

From table 3, it determines the significant value of uric acid levels towards systolic blood pressure ( $p = 0.907$ ) and uric acid levels towards diastolic blood pressure ( $p = 0.108$ ). It shows that there is no strong relation between independent variable and dependent variable in this study. The result of coefficient regression indicate any addition of 1mg/dL uric acid levels will increase systolic blood pressure up to 0.168 and diastolic blood pressure up to 1.376.

Regression test in this study shows that there is no significant impact of uric acid levels to hypertensive patients both in systolic blood pressure and diastolic blood pressure. The result is proved by the table P value  $> 0.05$ , which is  $p = 0.817$  in systolic blood pressure and  $p = 0.274$  in diastolic blood pressure. More specifically it can be seen from coefficient regression value. The result of coefficient regression indicate any addition of 1mg/dL uric acid levels will increase systolic blood pressure up to 0.168 and diastolic blood pressure up to 1.376.

The results of this study are not consistent compared to the results obtained by Mustazifah in 2010 which stated that patients with hyperuricemia have 16 times more likely to suffer hypertension compared to those who have normal level of uric acid and there was a significant relationship between hyperuricemia and hypertension with p value  $p = 0,001$ .

More specific study that had been conduct by Korea Association of Health Promotion suggest that there is no significant relationship between uric acid levels and blood pressure both in men and women aged  $\geq 60$  years (men  $p = 0.05$ ; women  $p = 0.12$ ).

The relationship between uric acid levels and blood pressure are known from many studies. But the relationship between uric acid levels and blood pressure in different age groups can not be explained yet.

In another study identifying the relationship between uric acid levels and blood pressure, it was found that the risk of hypertension is increased up to 13% with every 1 mg/dL of uric acid levels increasing, and this was more clearly to be found in younger individu and in women group (Grayson et al., 2011). The increasing of uric acid levels is significant in some conditions such as obesity, dyslipidemi, diabetes, smoker, and individu with decreased renal function in the progression of hypertension.

### 1.3 Relationship Between Uric Acid Levels and Hypertension

To determine the relationship between uric acid levels and hypertension this study used correlation test to identify the closeness relationship held between variables. The closeness relation in this study means the relationship between uric acid levels and blood pressure both systole and diastole. The decision made based on the spearman correlation test by comparing the significant value with a probability value (0.05). Whereas to determine the closeness relationship held between variables that are tested is views on the correlation coefficient value.

**Table 4** The result of Spearman Correlation Test

Variable	<i>P</i>	<i>R</i>
SBP	0.817	0.037
DBP	0.274	0.175

According to the correlation test results table based on decision making it can be conclude that there is no significant relationship between both uric acid levels and systolic blood pressure ( $p = 0.817$ ) and diastolic blood pressure ( $p = 0.247$ ). Based on spearman correlation test, it is identified that correlation coefficient of uric acid levels and systolic blood pressure ( $r = 0.37$ ) and uric acid levels and diastolic blood pressure ( $r = 0.175$ ), this value indicates that there is almost no relationship at all between both uric acid levels and systolic blood pressure and diastolic blood pressure.

Table 4 shows that uric acid levels barely has a correlation with both systolic ( $p=0.817$ ;  $r= 0.037$ ) and diastolic ( $p= 0.274$ ;  $r= 0.175$ ) blood pressure. Similar finding also can be seen in study done by Mustafiza (2010) that stated uric acid levels has moderate correlation with systolic blood pressure ( $p<0.001$ ,  $r=0.619$ ) and weak correlation with diastolic blood pressure ( $p<0.001$ ,  $r=0.460$ ) it indicates that the higher uric acid levels the higher systolic and diastolic blood pressure.

Another study stated that there is a positive correlation between uric acid with systolic ( $p=0.001$ ,  $r=0.269$ ) and diastolic ( $p=0.046$ ,  $r=0.153$ ) blood pressure (Feigh et al., 2008). The increase in blood pressure just like in hypertension condition will reduce blood flow to the kidney. low renal blood flow will stimulate the reabsorption of uric acid. In other hand, with increase of blood pressure the risk of mycrovascular disease will also increase that can lead to tissue ischemia. After that the ischemia itself will cause the release of lactate and increase the production of uric acid. Lactate inhibits secretion of uric acid by blocking organic anion transporter in distal tubules. The decrease of uric acid's secretion also caused by reduced amount of uric acid that is delivered to renal secretory tubules. Increased production of uric acid occurs due to ischemia that caused breakdown of ATP into adenosine and xanthine which are former product of uric acid formation. As a result, the level of uric acid increase.

#### **4. Conclusion**

This study conclude that there is no relationship between uric acid levels and risk factor in hypertensive patient.

#### **References**

- Badan Litbang Kesehatan Kemenkes RI. (2013). Riset kesehatan dasar 2013.
- Chernecky, C & Berger, B. (2012). Laboratory Tests and Diagnostic Procedures. USA : Saunders.
- Feigh, D. I., Johnson, R. J., & Kang, D.-H. (2008). Uric acid and cardiovascular risk. *N Engl J Med*, 359 (17), 1811-1821.
- Igrisa, V. J. (2015). Pengaruh Kompres Air Hangat Terhadap Penurunan Nyeri Penderita Gout Arthritis pada lansia. Gorontalo : UNG.
- Muttaqin, A. (2009). Pengantar asuhan keperawatan dengan gangguan sistem kardiovaskular. Jakarta: Salemba Medika.
- Rahajeng E, Tuminah S. (2009). Prevalensi Hipertensi dan Determinannya di Indonesia. Jakarta: Pusat Penelitian Biomedis dan Farmasi Badan Penelitian Kesehatan Departemen Kesehatan RI, Jakarta.
- Sidabuntar, R., & P, W. (1991). Ilmu penyakit dalam. Jakarta: Balai Penerbit FK-UI.
- Tambayong, J. (2000). Patofisiologi untuk keperawatan. Jakarta: EGC.
- World Health Organization (2010). Global Status Report on Noncommunicable disease. Switzerland: WHO.

---

**The Effect of Ethanolic Extract of seeds of pumpkin (*Cucurbita moschata*) on Bone Calcium Levels in Ovariectomized Rat**

**Sri Tasminatun<sup>a</sup>, Nuryanti<sup>a</sup>, Alfaina Wahyuni<sup>b</sup>**

<sup>a</sup>Pharmacy Study Programme, Faculty Medicine & Health Science, Universitas Muhammadiyah Yogyakarta 55183, Indonesia

<sup>b</sup> Medicine Science Study Programme, Faculty Medicine & Health Science Universitas Muhammadiyah Yogyakarta 55183, Indonesia

---

**Abstract**

This study outlines the effects of the ethanolic extracts of pumpkin (*Cucurbita moschata*) seeds on the bone calcium levels in ovariectomized (ovx) osteoporosis rat models. Thirty of 8-weeks-old female Sprague-Dawley rats were randomly assigned to six groups: Normal, OVX, OVX-Estradiol, OVX-ECM 100 mg/kg BW, OVX-ECM 200 mg/kg BW, OVX-ECM 400 mg/kg BW for 30 days. The administration of ECM and estradiol was given orally using a stomach tube. It is on the 31<sup>st</sup> day since the bones of femur and tibia rat were isolated. The isolated bones were analyzed using wet destruction and the bone calcium levels were measured using the AAS. The bone calcium level were tested statistically using one way ANOVA. The average of bone calcium levels for each group: for the normal group is  $18.30 \pm 3.17\%$ , OVX  $16.44 \pm 3.93\%$ , OVX-Estradiol  $16.59 \pm 2.63\%$ , and for the group of OVX-ECM dose 100, 200, 400 are  $17.79 \pm 2.88\%$ ,  $18.90 \pm 2.14\%$ , and  $18.28 \pm 3.76\%$  respectively. The conclusion is that the treatment of seeds of pumpkin (*Cucurbita moschata*) with the different dose of 100, 200, and 400 mg/kg BW for 30 days increase the bone calcium level in the ovariectomized rats. According to the statistical data, there was no significant differences among the treatment groups.

**Keywords**

Calcium ; *Cucurbita moschata*; Ethanolic Extract; seeds ; ovariectomized

---

\* Corresponding author.  
Tel.: +628997771645; fax: 62274387658.  
E-mail address: [sri.tasminatun@umy.ac.id](mailto:sri.tasminatun@umy.ac.id)

**1. Introduction**

Osteoporosis is a multifactorial progressive skeletal disorder characterized by reduced bone mass and deterioration of bone microarchitecture, predisposing it to increased fracture risk (Singh, et al., 2013). In the multinational European Vertebral Osteoporosis Study, the prevalence of vertebral deformities was similar among men and women at ages 65-69 years (12-13%). Approximately 40 in 100 women will experience

one or more fractures after the age of 50 years. At 50 years for women the lifetime risk is 17.5% for hip fracture, 16% for vertebral fracture, and 16% for Colles' fracture (Lips, 1997).

Menopause is a condition of the ovariums failure to produce estrogen. Estrogen hormone has a contribution to help the the calcium absorption in the intestine to maintain the bone density. Estrogens have been shown to be essential for maintaining a sufficiently high bone mineral density and ER alpha expression has been demonstrated in bone cells. The decreasing of the calcium absorbtion will disrupt the balance of the calcium in the blood because the low blood calcium may lead to the increasing of the calcium reabsorption in the bone and causes low bone mass. The decreasing of the calcium level in the bone due to estrogen deficiency called *postmenopausal osteoporosis* (Lane, 2001; Arts ,et al., 1997)

The injection of the hormone to substitute the estrogen (*Estrogen Replecement Therapy-ERT*) is commonly given to the menopause women to overcome the symptoms of post-menopause and to prevent chronic disease such as osteoporosis (Depkes RI, 2008). The mixture of the synthetic estrogen given as the therapy to substitute the hormone is expensive also it has the effects of adverse. Synthetic estrogen can interfere the blood clotting process, disturb the action of enzyme in the liver, causing endometrial uterine bleeding, nausea and vomitting The use of synthetic estrogen continuously can cause carcinoma ovarium. Besides, the use of estrogen and progesterone as the hormone replacement therapy can also be the risk of the breast cancer (Gang, et al., 1999 ; Ross, et al, 2000) Therefore, further exploration of alternatives and/or adjunctive approaches that can produce clinically relevant prevent bone loss like in osteoporosis would be interest. Non-hormonal therapy or natural product therapy may more acceptable for the treatment and prevent osteoporosis.

The existence of the side effects of the hormonal therapy. It is wiser to use phytoestrogen therapy as the alternative for the menopause women because it is saver (Rimoldi, et al., 2007). Phytoestrogens are estrogen-like compounds found in a wide variety of plants. Studies performed in vitro and using animal models report that these substances bind the estrogen receptor and exert hormonal and antihormonal effects (Kurzer, 2003). Accumulating evidence from reseach suggests that phytoestrogens may potentially confer health benefits related to osteoporosis and osteoporotic fractures (Tham, et al., 1998)

One of the plants that contain phytoestrogen substance is the seeds of pumpkin (*Cucurbita moschata*). The *C moschata* has phenolic glycoside phenylcarbinyl 5-O-(4-hydroxy)benzoyl-beta-D-apiofuranosyl beta-D-glucopyranoside, 1-O-benzyl[5-O-benzoyl-beta-D-apiofuranosyl]-beta-D-glucopyranoside, and cucurbitosides (Li, et al., 2009 ; Koike, et al, 2005). However, the estrogenic effect of phytoestrogen especially the effect on bone calcium level the from *C moschata* have not been investigated. This research aims to determine the effect of ethanolic effect of *C moschata* seeds on the bone calcium level in the ovariectomized rats.

## **2. Research Method**

### **2.1 Plant and Chemical Materials**

Seeds of pumpkin (*C moschata*)used in the present study were collected from Salatiga Indonesia and authenticated at the Laboratory of Plant Taxonomy, The Faculty ofBiology, Gadjah Mada University, Yogyakarta, Indonesia. Concentrated nitric acid

solution, Perchlorate acid solution, distilled water and Calcium Carbonate were obtained from LPPT Gadjah Mada University, Yogyakarta, Indonesia

## **2.2 The Preparation of Ethanolic Extract of seeds of pumpkin (*C moschata*)**

The dried powders of seeds of pumpkin (*C moschata*) were extracted by maseration using ethanolic 70%. The ethanolic extracts were evaporated to obtain the concentrated extract.

## **2.3 Animals**

Female Sprague–Dawley rats, aged 6 week, were purchased from Faculty of Medicine, Gadjah Mada University, Yogyakarta, Indonesia. The animals were grouped and maintained under the standard laboratory conditions with dark and light cycle (12/12 h) and allowed free access to commercial pellet diet and water ad libitum.

## **2.4 Administration Procedure**

Rats were acclimatized to laboratory condition for 1 week before the commencement of the experiment. Ovariectomized rat were done to all experimental animals except to the normal group. Animals were assigned to the experimental groups : normal, OVX, OVX-Estradiol, OVX-ECM 100 mg/kg BW, OVX-ECM 200 mg/kg BW, OVX-ECM 400 mg/kg BW, with five animals per group, per experiment. Twenty days after ovariectomized rat, all of the rats were allowed to the controlled access to a commercial standard pellet and to deionized water ad libitum for 20 days.

The extract of *C moschata* tuber was given orally once a day during 30 days and the doses are 100 mg/kg BW, 200 mg/kg BW, and 400 mg/kg BW to the experiemental group of OVX-ECM. The group of OVX-Estradiol was given estradiol with the dose of 2 µg/day, and the control groups and OVX did not get any treatment. On the 31<sup>st</sup> day, the rats were sacrificed and their thigh bones are taken to process measurement of bone calcium level.

## **2.5 The Measurement of Bone Calcium Level Using the Atomic Absorption Spectroscopy(AAS)**

The isolated bones were weighted to find out the weight of the bones. The sample of the isolated bones that had been weighted was to be destructed by using 15 ml HNO<sub>3</sub> and 3 ml HClO<sub>4</sub>, and heated until the bones dissolve in the solution and the solution became clear. The destruction was continued until ±3 ml left, then added 25 ml of distilled water to it. The solution of the sample was filtered and diluted using the distilled water until 100 ml. The sample as the result of destruction process was ready to be read at the absorbance part using the AAS at the wavelength of (λ) 422,7 nm. The result of the reading then was compared with the standard curve, therefore came up the level of bone calcium in mg/dl or ppm. The standard curve is the result of the absorbance measurement from several series dilution from calcium standard dilution. The concentrations of carbonic calcium (CaCO<sub>3</sub>) that was used as the standar solution are 0; 0,05; 0,1; 0,2; 0,5; 0,8; 1; 2; 3; 4; and 5 mg/L. The result of standard solution absorbance measurement would create the similarity on the linear lines that were used to find out the calcium level of the ovariectomized rat bones that were used as the sample.

## **2.6 Data Analisis**

The bone calcium level data from the animal experiments were expressed as the mean ± SD. The statistical significance of differences between the groups were assessed

with a one-way ANOVA, p values of less than 0.05 were considered to indicate significant differences.

### 3. Result and Discussion

The average of bone calcium level was gained from the measurement of bone calcium level in rats (*Rattus norvegicus*) *Sprague-Dawley strain* ovariectomized model. Those rats were given the therapy of etanolic extract of seeds of pumpkin (*C moschata*) and measured of bone calcium level with AAS methods. The result is shown in Table 1.

**Table 1.** The average of bone calcium level.

No	Group	Bone calcium level % $\pm$ SD
1.	Normal	18.30 $\pm$ 3.17
2.	OVX	16.44 $\pm$ 3.93
3.	OVX-Estradiol	16.59 $\pm$ 2.63
4.	OVX-ECM100mg/kg BW	17.79 $\pm$ 2.88
5.	OVX-ECM200 mg/kg BW	18.90 $\pm$ 2.14
6.	OVX-ECM400 mg/kg BW	18.28 $\pm$ 3.76

Ovariectomy is a process to take away the ovary in order to make the model rats become menopause. The assumption is that after the ovariectomy, the rats will experience the decreasing of estrogen hormone and it is similar to the hormone deficiency in menopause women. The decreasing of the estrogen hormone after the ovariectomy because the ovary as the hormone producer is already been removed. The decreasing of estrogen hormone in the animal model is proven by Hartiningsih *et al.*, (2010) who explains that the ovariectomy in rats can decrease drastically the estrogen hormone level, so the condition is similar to menopause.

The bone calcium level is different between normal group and OVX group. The normal rat treatment group is the groups that have normal ovary and they still produce estrogen endogenous hormone. The average of bone calcium level at the normal group is 18.30%, and it is higher than OVX group, 16.44%. Although the difference is not significant based on the statistical analysis. The decreasing of bone calcium in the OVX group is to prove that that estrogen deficiency in the ovariectomy rats also decrease the bone calcium level (Nurrochmad *et al.*, (2010) also state the same result.

Estrogen endogenous deficiency in the menopause women can lead to the increasing of osteoclastogenesis process and the loss of bone mass. In order to keep the estrogen balance, menopause women need to get substitute for the estrogen hormone. Estrogen intake can increase the apoptosis of osteoclasts as it hinders the formation of cytokine that can stimulate the osteoclasts differentiation (IL-1, IL-6, dan TNF- $\alpha$ ). Besides, the estrogen intake can also stimulate the *osteoprotegerin* (OPG) expression and TGF- $\beta$  (*Transforming Growth Factor- $\beta$* ) from the osteoblast and stroma cells, so the process can hamper bone resorption (NOS,2010 ; Kennedy *et al.*, 2008). It is in line with the result of calcium level in OVX-Estradiol, which get the Estradiol therapy. The average of the calcium level is 16.59% and it is higher than the OVX group.

The administration of ECM 200, 400 and 800 mg/kg BB effectively prevented OVX-induced lowering calcium bone level. ECM is phytoestrogens from seed *C.moschata* agent containing isoflavones types of phenolic glycosides. Phytoestrogens have two hydroxyl (OH). OH group that is the basic structure of a substrate in order to have estrogenic effects, so it is able to bind to estrogen receptors. The chemical structure of phytoestrogens have similar chemical structure to estrogen in mammals. Isoflavones are

phenolic ring on important structures in the majority of isoflavone components which serve to bind to the receptor estrogen (Hartiningsih, et al., 2010)

The mechanism of bone resorption which is mediated by osteoclast will damage the bone mineral crystals ligament that have the form of *calcium phosphatase* with the collagen matrix. The interaction of osteoclast with the bone surface during the process of resorption not only release some acids (for example citric acid, lactic acid) from the mitochondria and secretory vesicles, but also release the hydrogen ions through *carbonic anhydrase* dan *vacuolar ATPase pompa proton* channel. This condition creates acidic environment at the *resorptive pit* that cause the damage on the bone matrix. Osteoblast cells have a role to secrete the bone matrix component like collagen and proteoglycan. Collagen has function to give strength to matrix and binding the bone mineral salt. Proteoglycan has function to deposit the bone mineral (Hartiningsih, et al., 2010)

Calcium and phosphate salts are deposited on the surface of the bone maker cells as the non-crystal compound which then are converted into *hydroxyapatite*  $[Ca_{10}(PO_4)_6(OH)_2]$  of the bone major crystal salt. The function of *hydroxyapatite* is to keep the ion and give strength to the bone. Some *hydroxyapatites* stay in the form of non-crystal to facilitate the fast absorption when needed (Prabowo, et al, 2014)

The averages of bone calcium level from the treatment rat group of OVX-ECM 100; 200; 400 are 17.79%; 18.90%, 18.28% respectively. The averages are higher than OVX and OVX-Estradiol groups. The intakes of *C moschata seeds* extract for 30 days give effect to the increasing of the calcium level but it was not statistically significant. This effect seems to be proestrogenic compound, which suppress bone resorption by directly acting on estrogen receptor in bone sites.

#### 4. Conclusions

The administration of ethanolic extract of seeds of pumpkin (*Cucurbita moschata*) doses 100; 200; and 400 mg/kg BW during 30 days increase the bone calcium level in the ovariectomized rats. According to the statistical data, there was no significant differences among the treatment groups.

#### Acknowledgements

A sincere appreciation to the Research Grant of Directorate General of Higher Education Ministry of Research, Technology and Higher Education Republic of Indonesia which have funded this research.

#### References

- Arts J, Kuiper GG, Janssen JM, Guatafsson JA, Lowik CW, Pols HA, van Leeuwen JP. (1997). Differential expression of estrogen receptors alpha and beta mRNA during differentiation of human osteoblast SV-HFO cells. *Endocrinology*. 138(11) : 5067-70.
- Departemen Kesehatan Republik Indonesia.(2008). Osteoporosis Control Guidelines (Pedoman Pengendalian Osteoporosis). Keputusan Menteri Kesehatan Republik Indonesia No. 1142/MENKES/SK/XII/2008 : 3-4.

- Gang P, Kerlikowske K, Subak L, dan Grady D, (1999). Hormone Replacement Therapy and the Risk of Epithelial Ovarian Carcinoma: a Meta-Analysis. *Obs Gyn.*92: 472-479.
- Hartiningsih, Devita, A., Irkham, W. (2010). Effect of hysterectomy and Supplements Consumption of 1,25-Dihydroxy Vitamin D3 During 1.5 months against the retention of calcium in Wistar rats (Pengaruh histerektomi dan Konsumsi Suplemen 1,25-Dihidroksivitamin D3 Selama 1,5 Bulan terhadap Retensi Kalsium pada Tikus Wistar) . Lembaga Penelitian Universitas Gadjah Mada.
- Kennedy, P., Jain, A., Srinivasan, R., and Chaudhry, S. (2008). Bone Homeostasis. Artikel McMaster Pathophysiology Review . dari <http://www.pathophys.org/osteoporosis/>. Last Accesed 10 Juni 2015
- Kurzer , Mindy S. (2003 ). Phytoestrogen Supplement Use by Women. *J. Nutr.* 133: 1983S-1986S,
- Koike, K., Li, W., Liu, L., Hata, E., & Nikaïdo, T. (2005). New Phenolic Glycosides from The Seeds of *Cucurbita moschata*. *Chem. Pharm. PubMed Vol. 53 (2)*, 225-228.
- Li, F., Dou, D., Xu, L., Chi, X., Kang, T., & Kuang, H. (2009). New Phenolic Glycosides from The Seeds of *Cucurbita moschata*. *J. Asian. PubMed Vol 11 (7)*, 639-642.
- Lane, N E . (2001). *The Osteoporosis Book : A Guide for Patients and Their Families*. Oxford University Press, March
- Lips P. (1997) Epidemiology and predictors of fractures associated with osteoporosis. *Am J Med* 18;103(2A):3S-8S
- National Osteoporosis Foundation. (2010). *Clinician's Guide to Prevention and Treatment of Osteoporosis*. Washington DC: National Osteoporosis Foundation
- Nurrochmad A., Leviana F., Wulancarsari C. G., Lukitaningsih E., (2010). Phytoestrogens of *Pachyrhizuserosus* Prevent Bone Loss in an Ovariectomized Rat Model of Osteoporosis. *International Jurnal of Phytomedicine*, 2:363-372
- Prabowo, A.Y., Estiasih, T., Purwatiningrum, I., (2014). Gembili (*Dioscorea esculata* L.) as Food Contain Bioactive Compound: A Review. *J. Pangandan Agroindustri*, 2(3):129-135
- Ross RK, Paganini-Hill A, Wan PC, dan Pike MC., (2000). Effect of Hormone Replacement Therapy on Breast Cancer Risk: Estrogen Versus Estrogen Plus Progestin. *Natl Cancer Inst.* 92: 328-32
- Singh, H., Goyal M., Singh, J. (2013). Osteoporosis: Current Management Guidelines. *Indian Journal of Clinical Practice*, Vol. 23, No. 12
- Tham DM, Gardner CD, Haskell WL. (1998). Clinical review 97: Potential health benefits of dietary phytoestrogens: a review of the clinical, epidemiological, and mechanistic evidence. *J Clin Endocrinol Metab* ; 83(7):2223-35.



## **Redesign of Small Vehicles into a Safer Public Transit Transport Supporting Major Transport Lines**

Ismail Alif Siregar, Hari Nugraha, Jaya Dikusuma

*Universitas Pembangunan Jaya, Jl Cendrawasih Sawah Baru, Ciputat Tangerang Selatan  
Banten 15413, Indonesia*

---

### **Abstract**

Public transport is needed in cities as well as urban areas, For a developing country such as Indonesia, the rapid growth of infrastructure especially in the urban areas makes public transport as a vital part of the public needs. The transportation systems used in large cities such as Jakarta are city busses (Trans Jakarta), Electric trains (Commuter line trains) that could carry passengers in large numbers. This public transport carries passengers to major destinations inside the city.

Other mode of transportation that functions as a transit system to carry passengers from their homes to the major public transport lines, are small and under developed. These small transportations are made of smaller vehicles with a capacity of no more than 10 people and are not made and designed to high standard, such as ergonomic and safety standard of the larger transportation systems . Looking at these conditions, there is a need to redesign the small transportation system of these small vehicles so that it fulfils the basic ergonomic, comfort and safety standards. With the redesign it is hoped that this will to make passengers to be more comfortable and safe in using these public transport vehicles.

### **Keywords**

Public Transport; City; Ergonomics; Design; Transportation Design

---

### **1. Introduction**

According to a report done by Jeff Turner (2013), Jakarta, as the capitol city of Indonesia, faces increasing challenges in its transportation system. Especially with the growth of sattelite cities, the amount of traffic influx to Jakarta is presenting a problem to its transportation infrastructure. With a population of 9,6 million people, Jakarta transportation system has to also support its surrounding sattelite city Bogor Depok Tangerang and Bekasi which brings the total population to 26,6 million people. With this much people, transportation is needed for the daily commute of people from the surrounding cities of Jakarta. Wismadi, A., J. Soemardjito and H. Sutomo (2013) states that if nothing is done there would be a significant change for the worse in the volume and capacity ratio of the traffic.

**Table 1 The road based transportation performance in DKI Jakarta Province. Source JAPTraPis Report (2012)**

Indicators	2010 (Existing)	2020 (Do nothing)	2020 (masterplan do-something)
Cars	20%	28%	24%
Motorcycles	53%	50%	42%
Public Transport	27%	22%	34%
Traffic Performance Travel Speed	23.6 km/hour	15.2 km/hour	24.3 km/hour

To alleviate the problem, the government has devised a masterplan to revitalize the transportation system with Mass Public Transport systems. The major ones are the construction of the LRT (Light Rapid Transport), MRT (Mass Rapid Transport) and the Specialized Bus corridors which are projected to be completed by 2018 (Globe Asia Magazine, March 30 2016)



**Figure 1 Jakarta Traffic.**

## **2. Material and Methods**

### **2.1 Research Object**

Besides the main transportation systems, there is an overlooked segment which are the secondary transportation systems which connects the smaller towns in the satellite cities to the main transportation hubs. These are mainly provided by small vehicles that has been converted to be a passenger carrying vehicle. These are called AngKot (Angkutan Kota) and are the main transport systems of the smaller towns. They are made from commercial vehicles that has been modified by local coach builders.

According to an interview conducted with Mr Azas Tigor Nainggolan the head of the Jakarta Transportation Board, there are no minimum standard and so the AngKot are not regulated, which results in AngKot's that are not safe for the public (Metropolitan, December 25th 2011)

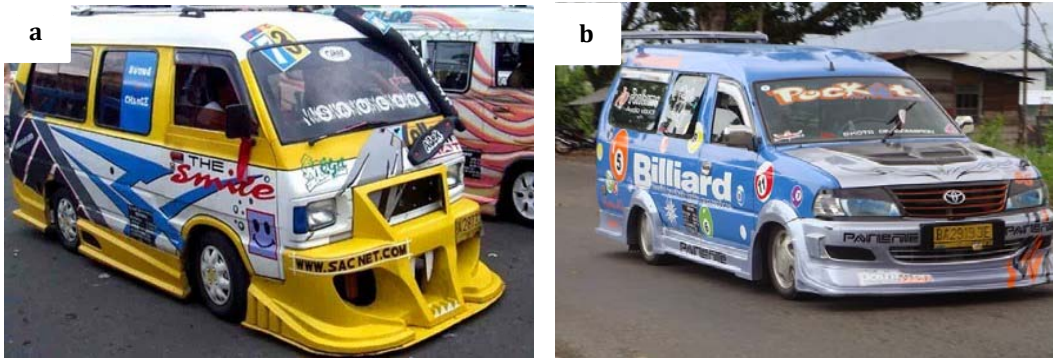

Figure 2 (a) Suzuki Carry based AngKot with exterior body modifications (b) Toyota Kijang with exterior body modifications

Besides the unauthorized modifications done to the exterior of the vehicle, the interior of the AngKot is also really unsuitable because of the small interior dimension. One of the main concern is the safety of passengers. There is a risk of crimes happening to female passengers because of the cramped seating positions. Because there is no space between sitting passengers it is possible for molestation and groping to happen because of the cramped interior (Megapolitan, June 22nd 2015). The interior space is further diminished by the installation of audio systems made by the drivers that does not adhere to any safety or good ergonomic standards.



Figure 3 (a) AngKot interior with Passengers. (b) AngKot interior modified with audio system.

Because Indonesia has no standards for small public transport, the researcher has based his guidelines on available regulations for public transport vehicles provided by the Ministry of Transportation (Peraturan Pemerintah Republik Indonesia No 55. 2012). As stated by Green (1999) There is a misconception that being a human being makes on a human factors/ergonomics expert, so non-experts often engage in professional practice, including standards development. This paper is an attempt by the researcher to provide an alternative design to the current practice that is made by the local coach builders.

The metode that will be used for this research will be qualitative as stated by Yin (2015), where the design of the previous vehicle will be compared to the proposed new design and then assessed. The design process will be as follows. Study of existing design

and problems, ergonomic considerations for the new design, application of ergonomic principles for the new AngKot design. The result of this design research can be applied to future AngKot design and production. The researcher will analyze the data available and do the following:

- Analyze the current available AngKot
- Identify Key issues
- Come up with design solution for the issues.

## 2.2. Design Issues of AngKot

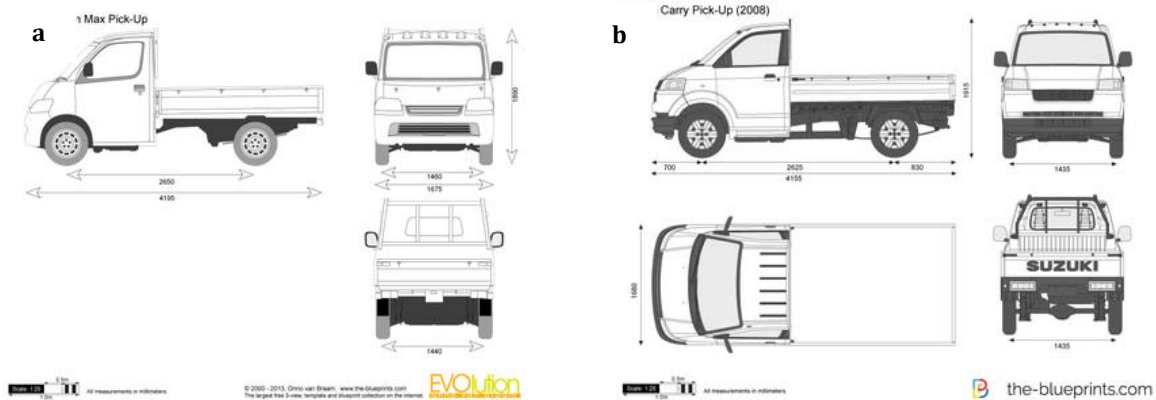

Figure 4 (a) Daihatsu Gran Max pickup. (b) Suzuki Carry pickup. Source: the-blueprints.com

Because the AngKot is based on a commercial vehicle which has been converted to a passenger vehicle with no basic or minimum design guide, the interior of the AngKot does not adhere to any standards at all. The commercial vehicles used are usually cargo vehicles, whose rear is converted. From the year 2010, the chassis that is widely used is the Daihatsu Gran Max Pickup and the Suzuki Carry

This type of vehicle is chosen because they are small, cheap, easy to maintain and run, and also of the load carrying capacity. Also because of the body on chassis construction, it is easy for coach builders to modify and build a body on top of the chassis.

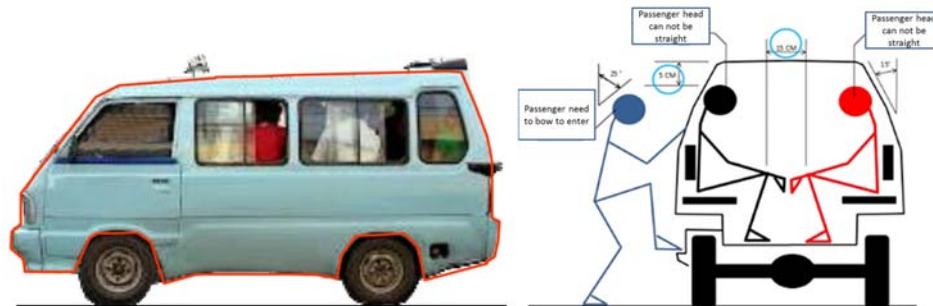

Figure 5 Analysis of current standard of AngKot interior

With the current AngKot, we can see that the interior does not adhere to any ergonomic or safety standards. With the unauthorized modifications made, even less room is available for the passengers, In the figure above, we can see how the passenger

has to bow their head up to 25° to enter. And inside the passengers have to keep their head down at an angle of 15° during the duration of their travel. The interior space also only leaves 5cm in space on the top of the passengers head with only 15 cm of space between opposing passengers. The Passengers capacity is 8 but is often over loaded to 12-14 passengers. This has resulted in situations where the passengers are sitting in an uncomfortable position, and the chance of crime such as theft and mollestations to happen increases

### **2.3 Redesign of AngKot Passenger Cabin**

According to Márquez and Garcia (2004) there are basic factors that must be considered when designing for passengers requirements, which are:

- Access and exit stairs of the transport units.
- Easy of displacement within the unit.
- Access to the seats.
- Space available in the seat for the user.
- Form of the seats and rakes of seat, and the back rest.
- Distribution of the seats.

Kogi (2007) states that a prolonged sitting in a confined space as a passenger increases the discomfort of passengers. The proposed design is aimed to improve the ergonomic standard of the interior space to make the passengers more comfortable and to redesign the entrance of the vehicle so that passengers can easily get in or out of the vehicle. Another concern is the ease of movement of the passengers. In order to fulfill these requirements, a larger space is needed so that the size and placements of the seats can be arranged more ergonomically. To be seated comfortably, the passenger chair must adhere to ergonomics standards for a chair, which according to Dreyfuss (1993) are:

- a. Seat height
- b. Seat Depth
- c. Seat Width
- d. Backrest Height
- e. Backrest Width
- f. Backrest Lumbar

According to Nurmianto (2008) the anthropometric data of Indonesians differs from anthropometrical data of Dreyfuss. The new design proposed will be based on the anthropometrical data of Indonesians based on recent data compiled by the Indonesian Ergonomics Society to fulfill these needs. To fulfill these criteria, the size of the interior compartment must be widened to allow space between passengers, and to heighten the interior compartment so that passengers no longer have to bend their neck. To allow easy access to the entrance and exit of the vehicle, the door size needs to be adjusted too, so that the passengers can enter and exit more comfortably. The sizing for these improvements will be set as a standard for the proposed AngKot regardless of the type of vehicle chassis used.

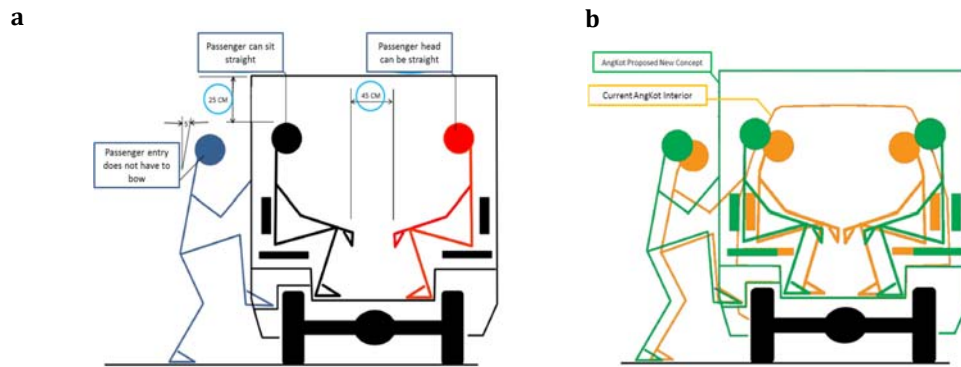

**Figure 6 (a) Illustration of Proposed Redesign of the AngKot interior layout. (b) Comparison of interior space between current AngKot and redesign concept**

Figures 6 (a) and (b) shows the comparison between the current AngKot interior space and the proposed redesign. The proposed design has a larger space to accommodate seats that are more ergonomic and allows for space to be available between facing passengers. This space would allow the ease of movements when a passenger enters the AngKot, also to allow them to move to find a seat easier and also make the movement to exit the vehicle easier. To do this we need to look at the anthropomorphical data of the Indonesian people when seated. Table 2 shows the current data that has been compiled by the Indonesian Ergonomic Society when it is applied to car seat.

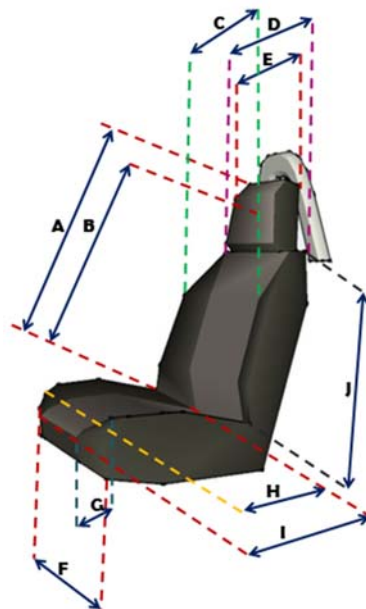

**Figure 7 Seat Anthropometrical requirements Source: Indonesia Ergonomic Society**

**Table 2 Indonesian Anthropometrical Seat Requirements Source: Indonesia Ergonomic Association**

Symbol	Part	5th	50th	95th
A	Height of Car Seat	64.89 cm	81.54 cm	98.18 cm
B	Eye Height while sitting	54.87 cm	71.34 cm	87.81 cm
C	Shoulder Width	57.11 cm	69.61 cm	82.1 cm
D	Upper Shoulder Width	45.97 cm	62.12 cm	78.28 cm
E	Width of Head	42.42 cm	46.07 cm	49.72 cm
F	Width of Seat base	52.52 cm	63.15 cm	73.78 cm
G	Length of Popliteal to	68.96 cm	90.32 cm	111.67 cm

H	Knee Length of Seat to Popliteal	31.5 cm	40.9 cm	50.3 cm
I	Length of seat to Knee	38.97 cm	50.92 cm	62.88 cm
J	Height of Shoulder while sitting	41.36 cm	58.53 cm	75.71 cm

To standardise the design of the AngKot, the redesigned passenger compartment is designed as a modular system so that it can be fitted onto different type of small commercial vehicle chassis. With this modular design, the passenger compartment can be standardised and hopefully be better regulated by the government. Even if the coach builder is different.

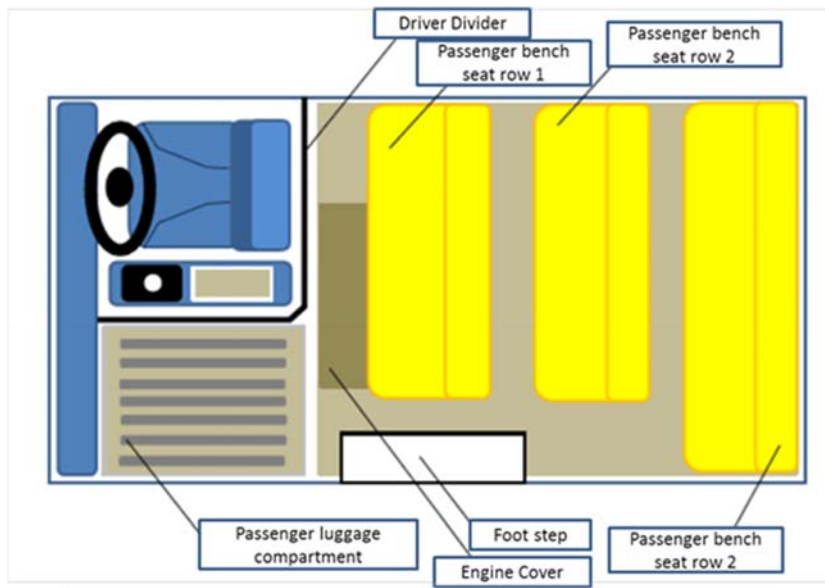

Figure 8 Illustration of Proposed Interior Layout for regular AngKot

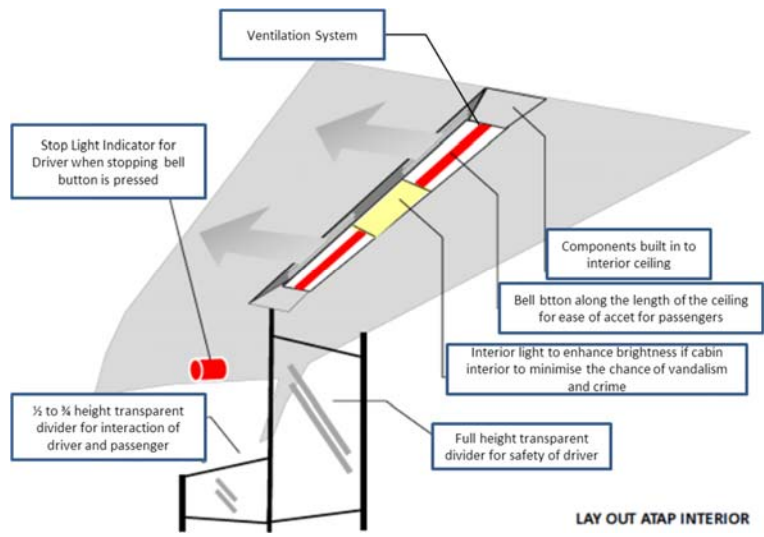
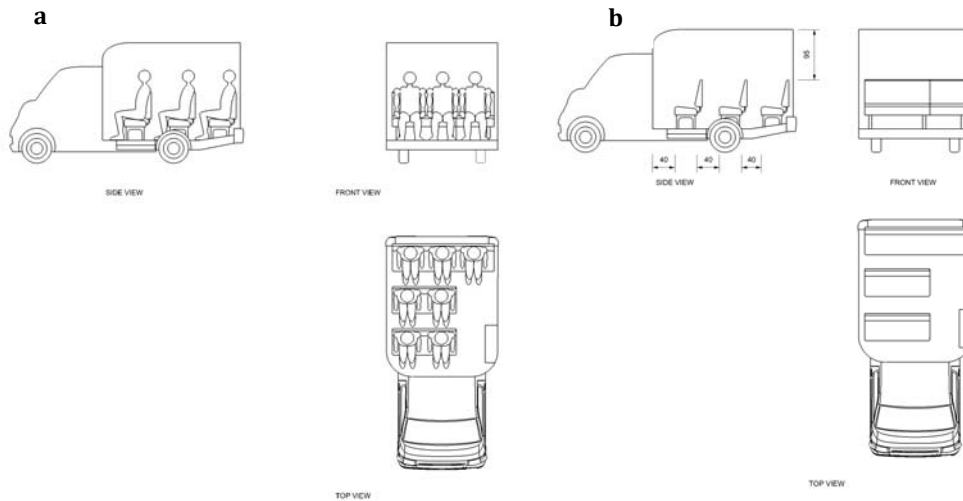

Figure 9 Illustration of Interior Design Concept

### 3. Result and Discussion



**Figure 10 (a) Interior Layout with passengers. (b) Interior dimensions**

The main focus of this research is the passenger cabin. Using the anthropomorphic and ergonomic standards set by Nurmiyanto (2008) and the latest data from the Indonesian Ergonomic Society as seen in table 2. Using the 5th-95th% percentile of the population as base numbers. The researcher used 3d modelling software to input the required anthropometric numbers for the proposed design to come up with the measurements of the passenger seats and interior space requirements of the proposed passenger cabin. The size of the cabin is only slightly larger than the base of the pick up cargo space. Figure 10 shows the design layout proposal, which maximizes seating position which can hold 7 passengers plus 1 standing for a total of 8 passengers. The front passenger space next to the driver is converted into extra luggage space so that passengers luggage does not interfere with the sitting space.

With this redesign, In comparison with the current AngKot, the designs main difference is the way the passengers are facing. The passengers is now facing forward instead of each other. The leg area is now 40cm apart, which allows easy movements for the passengers to get in and out of their seats. The design issues such as the high entry of the current AngKot is solved by using low floor entrance. Using the anthropometric data available, the dimensions of the seats and interiors are designed to be more suitable for Indonesian requirements. Passengers head space is now sufficient so that they do not have to bend their body and neck anymore. There is also space for passengers luggage to be palced on overhead compartments. With the space created to separate the passengers, it is hoped that unwanted criminal activities such as theft and molestation can be reduced. The large window openings also gives the effect of an airy interior and also improves lighting conditions of the interior space. The design of the AngKot cabin in this paper is hoped to be a base for the government of Indonesia as a starting point to develop a standard for small commercial vehicles that has been converted into passenger carriers (AngKot). With the suggestion made by the author, during the development of the AngKot, consultants who understand safety and ergonomics factor can be involved by the local coach builders, and the resulting design can be standardised by the government and implemented so that passengers can feel more comfortable and the safety issues regarding crime can be further minimised.



Because the design of the passenger cabin is designed to be modular. The cabin can be mounted on different type of small commercial vehicle chassis. With the modular design, it will be more easy to supervised by the government if any changes has been made illegally.

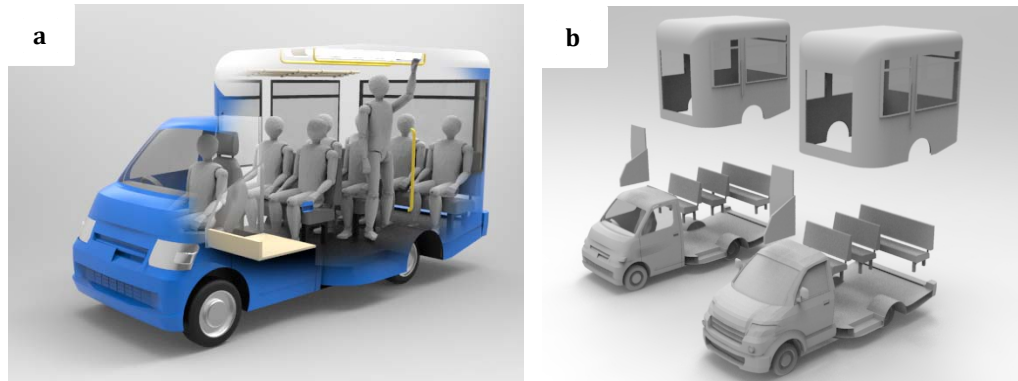

**Figure 11 (a) 3D render of cabin on Daihatsu Gran Max pickup chassis. (b) Modular cabin design can be fitted on different chassis**

## Acknowledgements

This research is made as one of the three pillars of university program, which is the Universitas Pembangunan Jaya Tri Dharma Universitas. It is hoped that this research will gain new insight into the development of transportation design, in this case public transport in Indonesia. Also it is hoped that this research can be used as a reference for further research in the future and also as an educational material. This research can be applied by the government as an input for making a standard for public transport based on small vehicles. Any input and critique would be appreciated by the research team so that we may better our research in the future. We also would like to thank all the other parties that has helped the research team during this research

## Reference

Green P. (2014) Why safety and Human Factors/Ergonomics standards are so difficult to establish [www.hfes-europe.org/wp-content/uploads/2014/06/2-tc.pdf](http://www.hfes-europe.org/wp-content/uploads/2014/06/2-tc.pdf) Last Accesed 10th November 2016

JICA (2012) Final Report. Volume 2. PROJECT FOR THE STUDY ON JABODETABEK PUBLIC TRANSPORTATION POLICY IMPLIMATATION STRATEGY IN THE REPUBLIC OF INDONESIA (JAPTraPIS)

JICA (2013) Final Report. REPUBLIC OF INDONESIA JAKARTA INTEGRATED URBAN TRANSPORT HUB DEVELOPMENT

Kogi. K (2007) Passenger Requirements and Ergonomics in Public Transport. The Official Journal of the Chartered Institute of Ergonomics and Human Factors. P. 631-639 | Published online: 27 Mar 2007

KOMPAS (2015) Ini Kasus-kasus Kejahatan Seksual yang Pernah Terjadi di Angkot Ibu Kota <http://megapolitan.kompas.com/read/2015/06/22/05035291/Ini.Kasus-kasus.Kejahatan.Seksual.yang.Pernah.Terjadi.di.Angkot.Ibu.Kota?page=all> Last Accesed 5th November 2016

INILAH (2011) Standar Pelayanan Minimum Angkutan Umum Diperlukan <http://metropolitan.inilah.com/read/detail/1811616/standar-pelayanan-minimum-angkutan-umum-diperlukan> Last Accesed 5th November 2016

Miguel, M.A (2004) Ergonomics of Urban Public Passangers Transportation. SCT Venezuela

Nurmantio. E (2008). "Ergonomi : Konsep Dasar dan Aplikasinya, Edisi Kedua". Guna Widya, Surabaya, Indonesia

Yin, Robert K. (2015) Qualitative Research from Start to Finish. 2nd edition. New York: Guilford,

Wisaksono, R. (2013). Pengembangan Desain Angkutan Kota Sebagai Transportasi Umum Terintegrasi di Kota Bandung. Jurnal Tingkat Sarjana Senirupa dan Desain No.1

---

## **Enliven Urban Life Through Third Places With Homelike Experience**

Nisrina Muthi Meidiani\*, Achmad Hery Fuad

*Department of Architecture, Faculty of Engineering, Universitas Indonesia, 16424, Indonesia*  
*Department of Architecture, Faculty of Engineering, Universitas Indonesia, 16424, Indonesia*

---

### **Abstract**

In an urban life, third place was considered to be the heart of a city, making a little part of a city as a source of comfort and alive. This paper aims to reveal the composing aspects of homelike quality that attracts people to come and stay in a third place. The case study was done in Hema Resto KemangPratama in Bekasi City through defamiliarization (Presscott-Steed, 2013) and interviews. The result shows that the reasons of people coming are because of the interaction and the interiority inside a third place that resemble a typical house. The case study shows that the interiority plays a bigger role in composing the homelike quality in attracting people to come to a third place through the borders from the study of space programming, accessibility, placements and arrangements.

### **Keywords**

Third place; homelike; places-for-things; borders; urban life.

---

### **1. Introduction**

In the modern era, people tend to finish their work in the most efficient way. They focus only on their everyday tasks—working, studying, waiting for the bus, running errands. These activities are called *necessary activities*, activities that are mostly would happen throughout everyone's days (Gehl, 1987). However, doing only this activity might lead to an individual life, dispersing the lively urban life that takes place in the city through the willingness of the citizen to gather around and simply connect to each other.

Chavis and Wandersmen (1990) said, that the quality of an environment depends on how well the citizens participate. They would watch over their neighborhood, preventing crimes and enhancing the social life. It is understood that the presence of people are playing a great importance in enliven the urban life.

Although Gehl (1987) agreed that people always attract other people, he and Oldenburg (1999) believed that there was something beyond that in which people tend to come for. It is the place. The inviting and easily accessible places encourage people to move from the private into public (Gehl, 1987). According to Oldenburg (1999), that place is called a *third place*.

---

\* Corresponding author. Tel.: +62-812-9908-6680  
E-mail address: nisrina.muthi@ui.ac.id

## 2. Material and Methods

A *third place* is a runaway place between the *first place*—home—and the *second place*—working places, such as school, office. It has the characters such of being on neutral ground, easily accessed, has regulars, being a leveler and low profile (Oldenburg, 1999).

According to Oldenburg (1999), a *third place* was considered as the heart of a city. It gathered people with or without reasons. They went there only to spend their time, making new *friends-by-set* and doing some conversation. They do not have to be someone else to impress other people, in *third place* it was a privilege to be themselves and still be accepted (Oldenburg, 1999). The feeling of freedom by being oneself without fearing to be judged was the reason why people want to come out of their places, they do not have to serve anyone else nor to be taken advantages of. This feeling was derived from the *homelike* quality that a *third place* possessed. It gives the regulars feeling to be back and to linger in the place (Campbell, 2014; Hickman, 2013; Matsuno, 2012; Oldenburg, 1999).

The theory of *home* was discussed for a long time in architectural field. Oldenburg (1999) stated that based on Heidegger's idea of *home* being the place where we dwell, a place with the quality of *home* is comfortable and has a congenial environment. A place that also has a similar character as a *home* is called *homelike* (Merriam-Webster, 2016) and is identified by the feeling of *at-homeness* as Seamon (1979) said.

*At-homeness* made out of a *center* inside oneself, a feeling that occurred after being in a specific place regularly it then became part of one's identity (Seamon, 1979). When someone has found his *center*, he is more likely to keep hanging around the area and staying there to spend times. He will remember the object around the place and marking them in their memories, showing the tendency of *places-for-things*. The forming of *center* and *places-for-things* shows that the place is emitting the feeling of *at-homeness*(Seamon, 1979). Thus indicating the *homelike* quality of the place itself.

According to Seamon (1979), there were five characters to satisfy the feeling of *at-homeness*. Those are rootedness, appropriation, regeneration, at-easiness, and warmth. It was shown that the aspects were much of the spatial one. However, based on a research conducted by Campbell (2014), physical choice also gave off the feeling of *homelike*. Both Campbell (2014) and Oldenburg (1999) agreed that avoiding formal appearances and making a place seemed like being taken care of would attract people to come. If the place looked worn but in good condition, it would give off the feeling of many people have come there and spend their times (Oldenburg, 1999). Gehl (1987) would agree on Oldenburg's (1999) statement, as he said that be it in neighborhood or a building, people and human activities would attract other people.

The finding of composing aspects of the *homelike* quality is shown in Table 1, where the discussion of the literature studies was done. The discussion was to find the aspects that could identify the *at-homeness* of a place as the form of *homelike* quality.

Table 1. Composing Aspects of *Homelike*(source: Author's, In Proceeding of IMC 2016)

Theorist	Character of Home	Composing Aspects
Seamon	Rootedness	A repeated experience of objects
		Time
	Appropriation	Territory
	Regeneration	Security
	At-Easiness	Marks
Campbell	Warmth	Another individual
		Memory of an object
		A taken care well of place
	Warmth	Lighting

	Centralized Activity	Placements
	Free to Interact	
Oldenburg	Informality	Decorations
	Taken care of	

The discussion was necessary to know the basic aspects to be focused on the observation of a *third place*, so that it could be known what aspects are related to the study. Table 1 shows that the repeated experience has an important role in making the *home* quality. It indicates that the *homelike* quality is actually happened because of interiority in a place itself. Using the lighting, decorations and placements as the critical point to make the memories experienced by the regulars is very important. They can intrigue the *places-for-things* inside the regulars. For example, the brighter side would be attracting to one regular or the seats in the back area are more comfortable for the large family because they rarely noticeable by other regulars. The study on those placements and program seem to be trivial, but it could build up the territory and marks so that people would feel comfortable around the area—thinking that it was their *place*.

The repeated experiences someone could get from the objects stated above are the one that identify the *center* and *places-for-things* of people and making them feel the familiarity. However, a familiarity could decrease the level of critical attitude that people have on their surroundings (Presscott-Steed, 2013), thus making them oblivious to the ones playing the important role in composing the *homelike* quality that attracts them to come to a place.

The observation was done in Hema Resto in Bekasi City with defamiliarization as a method. Defamiliarization was applied to enhance my sensitivity to the surroundings in order to find several important aspects to form the *homelike* quality in a *third place*. In everyday living people are accustomed to let things just happen in their ways, they somehow take the reasons behind them for granted. Since the *homelike* quality is formed through the familiarity over things, people tend to get comfortable and think that everything is supposed to be so. Ergo a critical way of deducting the composing aspects is needed.

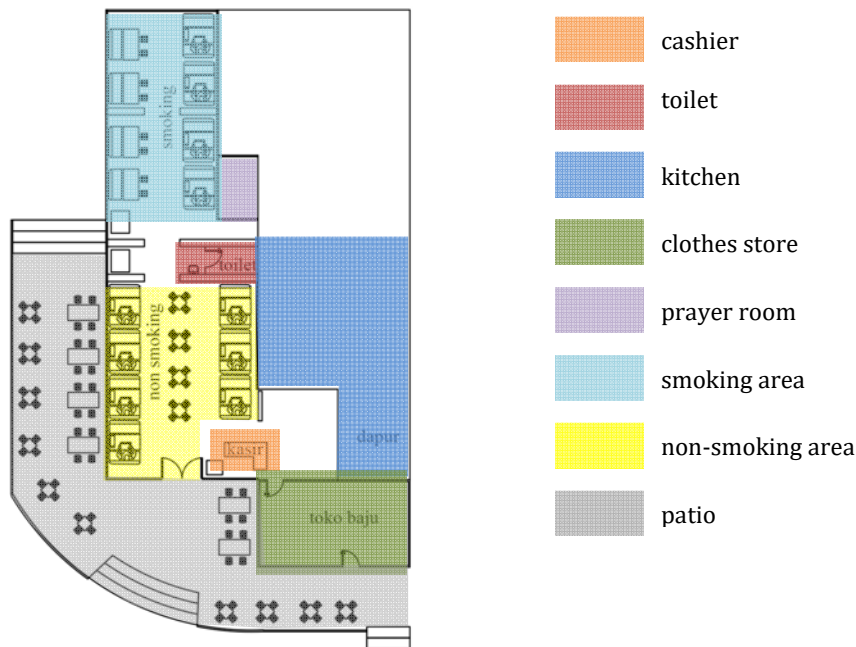

**Figure 1. Hema Resto Floor Plan**

However, defamiliarization is a method based on a personal experience process, so it was important to do some basic talks with a few regulars and waiters as to justify the view. We can see from the Figure 1, that Hema Resto has a three separated area, the patio—outdoor area—is located for the smoking area, it is more public to its surrounding, allowing people on the street to

see what the regulars were doing. The indoor ones were also separated. The first room after the entrance is made for the non-smoking area—the intimate one—while the further area is made for the smoking area yet more private than the patio. The place was already established for more than ten years and has become a gathering place since then.

The regulars often hold events in Hema Resto. The relationship between the regulars and the waitress is not just for the business but they are also friends. This proves Oldenburg's (1999) statement, a *friend-by-set* and a leveler where people don't have to worry about their social status. This *third place* usually rent their non-smoking private area for the events such as birthday or school reunion. Even so, because there were borders between the areas, the differences do not affect the regulars in each place.

### 3. Results and Discussion

Seamon (1987) stated that before people could make a *center*, they needed to get to know the place first. It then would establish the feeling of rootedness. When they know the place well, they would not have to feel awkward in the place and could act as they desired. Oldenburg (1999) and Campbell (2014) also mentioned the freedom to interact within the informality in a *third place*. Thus, freedom was an important part in making someone get the feel of *homelike* quality.

Table 2. Composing Aspects of *Homelike* in HemaResto

Composing Aspects	Hema Resto	<i>Homelike</i> Aspects in HemaResto
A repeated experience of objects	Lighting; Decorations; Parking Area	Placements; Programming
Time	No redesign	Design; Flexible borders
Territory	Flexible seating pattern	
Security	One accessible door; Closed area; Cashier as overlooker	Fix borders
Marks	Flexible seating pattern; Decorations; Space Programming; Casual shirt	Flexible borders; Placements
Another individual	Lighting colors; Decorations; Well taken cared	Placements; Programming; Design; Borders
Memory of an object	furnitures; Colors; Living room resembled;	
A taken care well of place	Waiter-Regulars relationship; No changing furnitures	
Lighting		
Placements		
Decorations		

In the case study, the freedom that people possessed is shown through the flexible boundaries as seen in the Table 2. The territory and marks possessed the overall composing aspects such as placements, decorations and lightings.

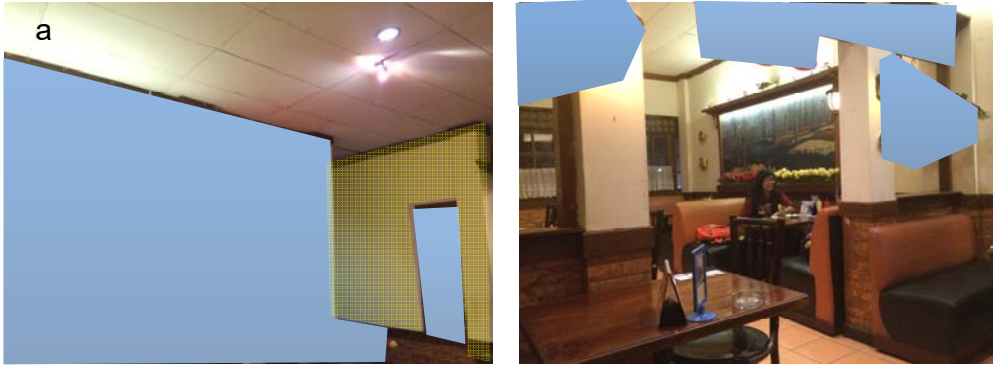

Figure 2. (a) decorations as boundaries; (b) decorations as room divider

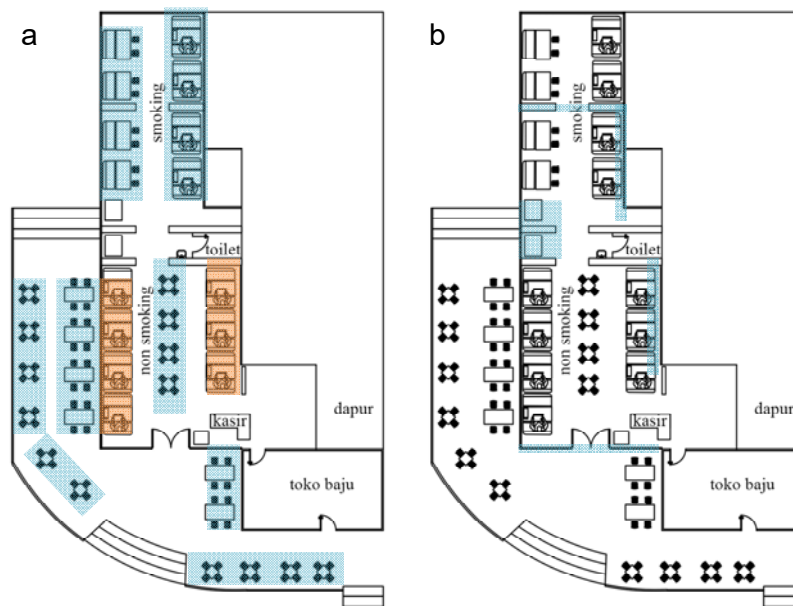

Figure 3. (a) seating pattern; (b) placements of decorations

Figure 3(a) shows that the seating pattern itself creates a boundary between them. Those in orange shades are the ones permanently placed so it would be hard to be moved around. However, those in blue shades could create their own seating pattern. As one of the interviewees stated, that Hema Resto is likely to be a place for a gathering, so it is necessary to make the pattern flexible. By changing the pattern, the space could be more open and less dispersed. In that way, they also can centralize the activity as stated by Campbell in Table 1.

Figure 3(b) is backing up the fact that a placement can be the boundary. As seen on it, the decorations are mostly placed as the marks of each area. The front door decorations separate the outdoor and indoor area, and the decorations inside is separating the smoking and non-smoking area. The choosing of decorations tells the story of different space programming, where each decoration leads to another room with different character.

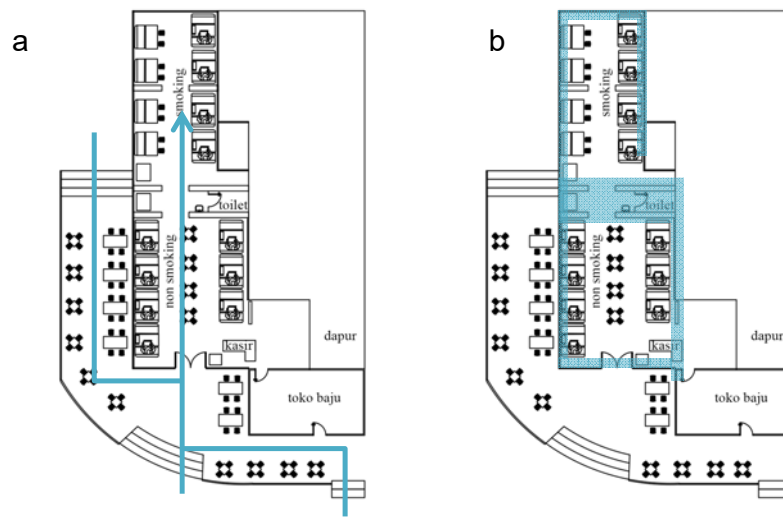

Figure 4. (a) accessibility; (b) divider

Figure 4(a) shows the only access the regulars could come inside Hema Resto and also how openly accessible the outdoor area is, while figure 4(b) shows the physical border is made inside the *third place*. While the indoor area is closed with walls, windows and doors, the outdoor one is in a form of patio so the border is blurred with the surroundings, making it connected to the streets in front and behind the place.

Figure 4(a) and 4(b) also show the fact that the interiority has formed the boundary inside the place itself. The lightings and decorations also show that the deeper the area is, the more intimate the color gets. While the outdoor lightings are chosen to be bright, the indoor ones are more of *incandescent* and warm. Showing clearly of how the rooms are divided. It is set to distinguish the public and less public area, where the regulars can choose which place to spend their time.



Figure 5. (a) outdoor lighting; (b) indoor lighting

This study confirms the earlier study (Meidiani, 2016a) that finds object placements can form a *homelike* quality. Those placements then create a boundary in between, showing people which area is able to be interrupted and which is not.

Based on the study of what composed the *homelike* quality, it is clear that those borders that are made out of the interiority are much of the borders of a house. People tend to make their houses have a layer of boundary from less private to more private ones. The layers are shown on how they choose the programming, from the patio area where people can easily accessed, to the non-smoking area that resemble the welcoming to the house like a living room, and up to the smoking area where the closed gatherings are usually held and only those who are invited could come there.

This shows the tendency that people are able to spend their time more in the Hema Resto because it has similar layers of borders like a house does. Their memory of *places-for-things*



shows in the choice of place and lead them to choose the *third place* itself. They know where should they go to get more private and less private place inside Hema Resto.

Like living in a house, they have the control over the borders in Hema Resto. They are able to move around the chairs and make their own borders, not only physically but also spatially through the seating pattern. But the initial border that separate the outdoor and indoor is still there, making them feel secure like a house also does.

In conclusion, to make sure that the *third place* is *homelike*, as it is found in the case study, a *third place* should has the layers of borders that resemble a typical house. The flexible borders that can make them separate the public and private, yet can be rearranged to their needs. The flexible border can be made out of the seating pattern, divider, access, or even lighting choices. The forming of the flexible borders is important since it will remind them of the pattern in a typical house, thus making people want to spend their time and make that specific *third place* as their *center*. As stated before, a *center* would make someone to get the feeling of coming back. Thus, it could be the reason for the people to gather around and enliven the urban life around their area.

## Acknowledgment

The authors wish to thank the manager, the waiter, the waitress and the regulars of Hema Resto for their input and cooperation on this research.

## References

- Campbell, N.M. (2014). Designing Retirement Community Third Places: Attributes Impacting Howe Well Social Spaces are Liked and Used. *Journal of Interior Design*, Vol. 39, No. 4, pp.1-14. Wiley/Blackwell.
- Chavis, D. M., & Wandersman, A. (1990). Sense of Community in the Urban Environment: A Catalyst for Participation and Community Development. *American Journal of Community Psychology*, Vol. 18, pp.55-56.
- Gehl, J. (1987). *Life Between Buildings*, Van Nostrand Reinhold, New York, New York.
- Hickman, P. (2013). "Third Places" and Social Interaction in Deprived Neighborhoods in Great Britain. *Journal of Housing and the Built Environment*, Vol. 28, pp.221-236.
- Meidiani, N.M. (2016a). Aspects in Composing the Quality of Homelike in Third Place (Case Study: Hema Resto KemangPratama, Bekasi). In *Proceedings of International Multidisciplinary Conference (IMC 2016)*, Jakarta, Indonesia.
- Merriam-Webster. (2016). Homelike. <http://www.merriam-webster.com/dictionary/homelike>. Last Accessed 18 April 2016.
- Matsuno, H. (2012). *Multi-Ethnic Third Place: Community Center in Wilshire Neighborhood of Los Angeles*. University of Washington, Architecture. Ann Arbor: ProQuest LLC.
- Oldenburg, R. (1999). *The Great Good Place*, Da Capo Press, Cambridge.
- Oldenburg, R. (2001). *Celebrating the Third Place*, Marlowe&Company, USA.
- Seamon, D. (1979). *A Geography of the Lifeworld: Movement, Rest and Encounter*, Croom Helm, London.

---

## Location-based Service for Jakarta's Bajaj Auto Rickshaw Ordering System

Ipank Sidiq P.<sup>a</sup>, Suwasti Broto<sup>a</sup>, Lestari Margatama<sup>b\*</sup>

<sup>a</sup>*Faculty of Engineering, Budi Luhur University, Jl. Cileduk Raya Petukangan Utara, Jakarta Selatan 12260 Indonesia*

<sup>b</sup>*Faculty of Information Technology, Budi Luhur University, Jakarta Selatan 12260 Indonesia*

---

### Abstract

This paper presented a Location Based Service booking system using GPS on smart phones for auto rickshaw transportation in Jakarta. This system is used to determine the state of the point latitude coordinates (latitude) and longitude (longitude) and distance of the vehicle closest to the person who booked the services of the three-wheeler. The vehicle tracking system needed to facilitate the booking of vehicles in combination with the system contained on the devices used on the vehicle buyer, so when passenger can view nearest location of available auto rickshaw. The system tracks the coordinates of the auto rickshaw from GPS on the driver's smart phone. In contrast to currently existing system, the passengers have higher degree of confidence offered by the ability to choose which available rickshaw to call, and a pre-deal with the driver when he confirms the order. In case of the selected rickshaw not responding the order, the passenger can switch to other available rickshaws.

### Keywords

Auto Rickshaw; Bajaj(vehicle type); Global Positioning System; Location Based Service; online transport ordering service

---

### 1. Introduction

Bajaj auto rickshaw was introduced to Jakarta in the 1970s to replace becak (rickshaw), which, being propelled by human power, is deemed inhumane by the government. Alongside passenger cars, buses/trucks, and motorcycles, Bajaj auto rickshaw is classified as Kendaraan Jenis IV (Type-4 Vehicle) in Jakarta. The vehicle itself is derived from Italian Piaggio Vespa scooter and modified under license by Bajaj of India is known for its sturdy and reliability; it can carry 2 passengers and cargo.

Although an official form of public transportation, Bajaj is practically neglected by the regulation, with further restriction from operating on main streets of Jakarta. Advances in technology helped digitize gadgets and equipments used by people, including maps. Digital maps fulfill every need like navigation and point location has seen widespread use on private and public vehicles (Deb, 2010). With, Global Positioning System (GPS), this system can pinpoint the current position of the user (Patil, 2015). The system discussed here is designed to facilitate easier order by auto

---

\* Corresponding author. Tel.: +62-815-900-2870; fax: +62-21-737-1164.  
E-mail address: margatama@najwaputrilarasati.com

rickshaw passenger in locating the nearest available auto rickshaw by the use of GPS service on the user's smart phone, and the Bajaj driver can also locate the passenger more easily (Pan, 2013).

## 2. System Design

The principle of the system centers on internet web service communications. Passenger and Bajaj Registration IDs are stored in the server. Passenger looks on a list of the nearest available Bajaj auto rickshaws, select one, and the system will send notification message to the selected rickshaw. The order then enters a pre-deal when the driver confirmed the order to pick up the passenger, the ordering passenger then received confirmation message. The process flow of the system is depicted in Figure 2.

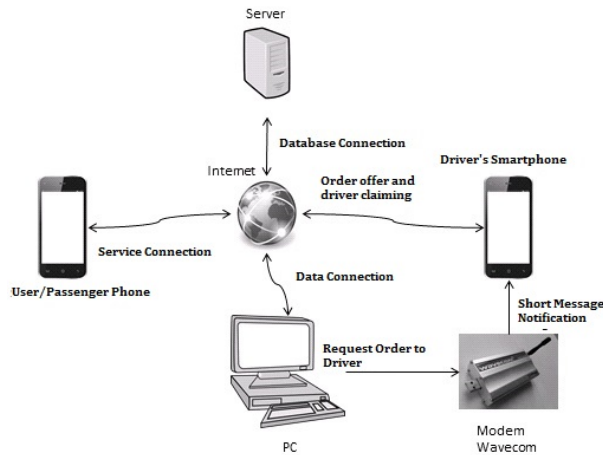

Figure 1. System overview

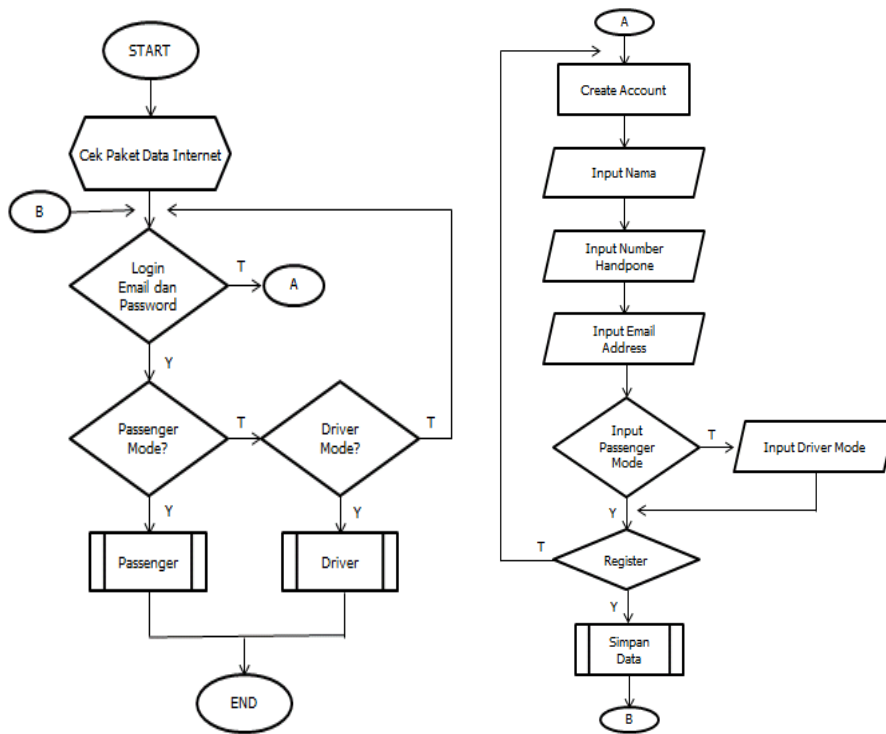

Figure 2. Process flow diagram

### 3. Testing and Analysis

#### 3.1. *Bajak (Bajaj Jakarta) Application*

The purpose of this application is to facilitate easier Bajaj ordering by both the passenger and the Bajaj driver. To ensure the identity of both parties, driver and passenger must be registered to the system.



Figure 3. Main screen



Figure 4. Register screen

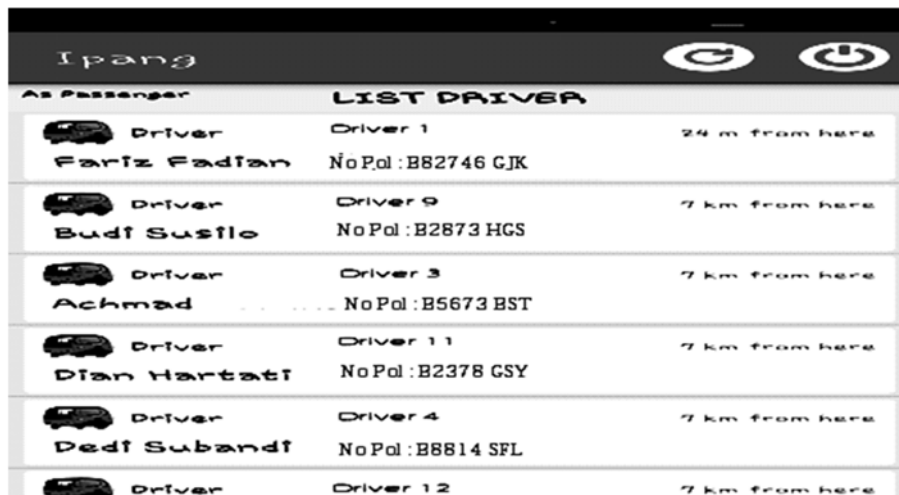

Figure 5. Passenger's list of nearby available drivers

### 3.2. Distance Calculation

Distance between passenger and drivers location in Figure 6 is calculated by determining the difference of the position with Pythagoras triangular equation on the decimal longitude-latitude values.

$$n = \sqrt{(Lat_2 - Lat_1)^2 + (Long_2 - Long_1)^2} \quad (1)$$

Since one degree of Longitude and Latitude equals to 111,32 km on the region near the equator, the distance between the two points can be calculated as:

$$d = n \times 111,32km \quad (2)$$

### 3.3. Server's Database

The following figures depicted the user database and their transaction history.

id	name	mobile	email	password	type
1	Fariz Fadian	083672720443	farishash@gmail.com	e10adc3949ba59abbe56e057f20f883e	Driver
2	Adik Widiasmono		adik.widiasmono@gmail.com	e10adc3949ba59abbe56e057f20f883e	Passenger
3	Achmad Zulfikar		achmad.zulfikar@gmail.com	e10adc3949ba59abbe56e057f20f883e	Driver
4	Dedi Subandi		dedi.subandi@gmail.com	e10adc3949ba59abbe56e057f20f883e	Driver
5	Ipang	089664524329	ipang@gmail.com	e10adc3949ba59abbe56e057f20f883e	Passenger
6	Joko Susilo		joko.susilo@gmail.com	e10adc3949ba59abbe56e057f20f883e	Passenger
7	Tono Haryono		tono.haryono@gmail.com	e10adc3949ba59abbe56e057f20f883e	Passenger
8	Neysa		neysa@gmail.com	e10adc3949ba59abbe56e057f20f883e	Passenger
9	Budi Susilo		budi.susilo@gmail.com	e10adc3949ba59abbe56e057f20f883e	Driver
10	Kirana		kirana@gmail.com	e10adc3949ba59abbe56e057f20f883e	Passenger
11	Dian Hartati		dian.hartati@gmail.com	e10adc3949ba59abbe56e057f20f883e	Driver
14	reza	085775094383	rezaharyanto@gmail.com	e10adc3949ba59abbe56e057f20f883e	Passenger
12	Rahmat Sofyan		rahmat.sofyan@gmail.com	e10adc3949ba59abbe56e057f20f883e	Driver
13	ipank sidiq	089664524329	ipanksidipambayun@gmail.com	5e8797ec69d4788366824a42b1c20639	Passenger

Figure 6. Users database

id	passenger_id	driver_id	status	sms_status	start_time	finish_time
1	13	1	Waiting	1	2015-05-25 23:45:58	0000-00-00 00:00:00
2	13	1	Waiting	1	2015-05-26 00:00:54	0000-00-00 00:00:00
3	13	1	Waiting	1	2015-05-26 00:13:10	0000-00-00 00:00:00
4	13	1	Waiting	1	2015-05-26 00:16:38	0000-00-00 00:00:00
5	13	1	Waiting	1	2015-05-26 00:16:59	0000-00-00 00:00:00
6	13	1	Waiting	1	2015-05-26 00:17:50	0000-00-00 00:00:00
7	13	1	Waiting	1	2015-05-26 00:27:38	0000-00-00 00:00:00
8	13	1	Waiting	1	2015-05-26 02:38:05	0000-00-00 00:00:00
9	8	1	Waiting	1	2015-06-12 23:52:25	0000-00-00 00:00:00
10	19	18	Waiting	1	2015-06-16 02:22:59	0000-00-00 00:00:00
11	19	18	Waiting	1	2015-06-16 02:24:07	0000-00-00 00:00:00
12	19	18	Waiting	1	2015-06-16 02:50:20	0000-00-00 00:00:00
13	19	18	Waiting	1	2015-06-16 02:51:04	0000-00-00 00:00:00
14	19	18	Waiting	1	2015-06-16 02:51:37	0000-00-00 00:00:00
15	19	18	Waiting	1	2015-06-16 02:52:16	0000-00-00 00:00:00
16	19	18	Waiting	1	2015-06-16 03:18:09	0000-00-00 00:00:00
17	19	18	Waiting	0	2015-06-23 01:06:09	0000-00-00 00:00:00
18	13	18	Waiting	0	2015-06-23 01:06:53	0000-00-00 00:00:00
19	19	18	Waiting	0	2015-06-23 01:07:02	0000-00-00 00:00:00
20	19	18	Waiting	0	2015-06-23 01:07:05	0000-00-00 00:00:00
21	13	18	Waiting	0	2015-06-23 01:07:08	0000-00-00 00:00:00
22	19	18	Waiting	0	2015-06-23 01:07:30	0000-00-00 00:00:00
23	19	18	Waiting	0	2015-06-23 01:07:32	0000-00-00 00:00:00

Figure 7. Users transaction history

### 3.4. PDCS (Passenger-Driver Connecting System)

The ordering system utilizes short message notification between passenger and driver to do the pickup. Only on duty drivers with available status are able to receive messages, since off duty drivers did not appear on the list of available drivers. In case of off duty drivers forgot to change their status and receive call order, the system has a limit of 3 minutes for a driver to respond, if the driver did not respond by confirming the order, the pre-deal is cancelled and the driver's status is changed to off duty. Meanwhile,

notification is sent to the passenger to select another rickshaw and other drivers can also take bid for the order. Considering the habit of most Indonesian mobile phone users still use short messaging service (SMS).



Figure 9. System messaging (a) Passenger call on Driver's phone, (b) Driver confirmation on Passenger's phone, and (c) Driver unable to comply

#### 4. Conclusion

Following the test and evaluation of the system's prototype, some conclusions can be drawn as follows:

1. Distance calculation is currently based on straight line, it still in the process to determine the actual travel distance and, complemented with traffic data, travel time for the driver to reach the passenger,
2. The Bajak application is still in user's manual refresh to update the latest information on vacant drivers and available passengers,
3. Jitters in longitude/latitude reading on smart phone of up to 50 m radius due to the accuracy of the built in GPS receiver

#### References

- Deb, P., et al. (2010), Offline Navigation System for Mobile Devices, Int. J. of Software Engineering & Applications, Vol.1, No.2, pp.30-43
- Pan, G. (2013), Study On Taxi Synergic Operation Dispatch System Based On Information Integration, Journal of Theoretical and Applied Information Technology, Vol. 47 No. 1, pp.246-250
- Patil, S.P., et al. (2015), Vehicle Automation Management in Urban Area, Int. J. of Scientific Research & Development, Vol.2, Issue 12, pp.552-555

---

**ENHANCE PRODUCTION OF ADVENTITIOUS ROOT BIOMASS OF  
*Talinum paniculatum* Gaertn. IN BALOON TYPE BUBBLE  
BIOREACTOR USED BATCH AND CONTINUOUS SYSTEM**

**M. Hamzah Solim<sup>a</sup>, A. Novi Kristanti<sup>b</sup>, Y.S. Wulan Manuhara<sup>a\*</sup>**

<sup>a</sup>Department of Biology, Faculty of Science and Technology, Airlangga University,  
Surabaya, 60115, Indonesia

<sup>b</sup>Department of Chemistry, Faculty of Science and Technology, Airlangga University,  
Surabaya, 60115, Indonesia

---

**Abstract**

*Talinum paniculatum* Gaertn is one of traditional medicine plants which was commonly used in Indonesia. Growth of its plant is low in natural habitat, especially root organ. Root organ contain bioactive compounds, one of them is saponin. This compound has benefits such as aphrodisiac, anti-inflammation and maintain blood circulation. Accumulation of its compound was found in root organ, so enhance production of adventitious root biomass in liquid culture system have potential to produce raw material as source of pharmaceutical industry. This research was conducted to enhance production of adventitious root biomass of *T. paniculatum* Gaertn in baloon type bubble bioreactor used batch and continuous system. Adventitious root biomass were induced from leaves as explant and were cultured in baloon type bubble bioreactor 1000 mL with 350 mL MS medium supplemented with 2 mgL<sup>-1</sup> IBA and aeration rate was set 0.2 vvm. Results shown that continuous system + buffer is better than batch system, which produced biomass four fold of initial inoculum. Continuous system provide biomass production better than the others and supplemented of buffer (NaHCO<sub>3</sub>) influence biomass productivity.

**Keywords**

Batch; Bioreactor; Continuous; NaHCO<sub>3</sub>; *Talinum paniculatum*

---

**1. Introduction**

*T. paniculatum* Gaertn. is herbaceous plant which classified into Portulacaceae family. This plant has a bulging shape of the roots similar with root of *Panax ginseng* and used as traditional medicine plant in Indonesia namely Java ginseng. Root organ contain bioactive compounds, one of them is saponin. This compound has benefits such as aphrodisiac, anti-inflammation and maintain blood circulation. But, growth of Java ginseng root very slowly in their natural habitat. Manuhara *et al.* (2015) reported that it has known that saponins level of java ginseng roots of three months was lower than the java ginseng roots growing in vitro for 28 days.

---

\* Corresponding author. Tel.: +62817584872 ; fax: +62-31-5936502  
E-mail address: wulanmanuhara@gmail.com

Plant cell, tissue and organ culture were often an effective system under in vitro conditions to study the biological significance of bioactive metabolites, as well as for producing natural products (Cui *et al.*, 2014). Several secondary metabolites of pharmaceutical interest are accumulated in adventitious roots culture. That culture can be developed by bioreactor. One of bioreactors for adventitious root culture was Baloon Type Bubble Bioreactor (BTBB). Many research used the bioreactor to culture many plants such as *Eurycoma longifolia* (Lulu *et al.*, 2015) and *Morinda citrifolia* (Baque *et al.*, 2013). The use of bioreactors for large-scale cultivation of cells and adventitious roots has become feasible for the production of biomass and metabolites (Lulu *et al.* 2015; Paek *et al.*, 2009; Cui *et al.*, 2014). Sajc *et al.*, (2000) explained that bioreactor designs currently used to to specific operating parameters that can be varied to modulate growth of cell and function in order to optimize product release and separation. Further, the adventitious roots have a higher stability in the chemical and physical conditions to accumulate large quantities of bioactive compounds on intercellular spaces, which can be more easily isolated (Sivakumar, 2005). Optimization and scale-up was required to increase root biomass and secondary metabolites (Choi *et al.*, 2000; Yu *et al.*, 2001). Optimization to increase adventitious root biomass and secondary metabolites had successfull in BTBB (Manuhara *et al.*, 2015). Paek *et al.*, (2005) described that bioreactor methodologies for adventitious root cultures also have to be developed.

Many factors can affect production of biomass and secondary metabolites of adventitious root production during scale-up such as aeration, agitation, pH and inoculum density, IBA and culture method. The aeration volume in the bioreactors was an important factor which control the accumulation of biomass and metabolites production (Baque *et al.*, 2013). The plant cells have perceived sensitivity to hydrodynamic stress associated with aeration and agitation of the suspended cell. Besides, Hahn *et al.* (2003) reported that the accumulation were strongly inhibited when pH was maintained below 4 or above 7. Meanwhile, inoculums density also influenced production in a number of plant cell culture system (Baque *et al.*, 2013). Furthermore, Indole-3-butyric acid (IBA) is widely used in agriculture because it induces rooting (Zolman *et al.*, 2000). In the culture method, Sajc *et al.*, (2000) described that batch cultivations were characterized by constantly changing environmental conditions and capable of producing metabolites associated with any kinetic pattern. Batch studies are used to determine the conditions for maximum productivity. These conditions was controlled addition of a limiting nutrient. Meanwhile, a continuous flow reactor with cell recycle was a flexible cultivation system. Continuous flow with complete cell recycle is often referred to as a perfusion culture. Therefore, the objective of the present study was to develop a protocol for *T. Paniculatum* Gaertn. adventitious root culture for enhance production of biomass used batch and continuous system in bubble type balloon bioreactor.

## Material and Methods

### *Plant material and adventitious root culture*

The study was carried out in the plant physiology laboratory at Departement of Biology, Faculty of Science and Technology, Airlangga University between December 2015 - July 2016. Adventitious roots were induced from leaves of *T. paniculatum* Gaertn. on solid MS (Murashige and Skoog's, 1962) medium supplemented with 7 gL<sup>-1</sup> agar, 30 gL<sup>-1</sup> sucrose and 2 mgL<sup>-1</sup> indole-3-butyric acid (IBA). Samples of leaf (length 2 cm) were the second leaf from shoot tip. All of the explants were washed with detergent and thoroughly under tap water for 15 minutes. Then surface of the explants were sterilized by 5 % (w/v) HgCl<sub>2</sub> for 5 minutes under laminar airflow. After that, explants were washed 3-4 times with sterile distilled water. The cultures were planted in Petri dish containing 25 mL medium and pH was adjusted to 5.8 with 1.0 N HCl or 1.0 N NaOH before adding 7 gL<sup>-1</sup> agar and autoclaving at 121 °C for 20 min. After five weeks, the



adventitious roots were transferred to liquid MS medium supplemented with 2 mgL<sup>-1</sup> IBA in the BTBB.

#### *Baloon type bubble bioreactor (BTBB) Design*

Bioreactor with a capacity of 1 L was filled with 350 mL of liquid MS medium supplemented with 2 mgL<sup>-1</sup> IBA and 30 mgL<sup>-1</sup> sucrose and sterilized by autoclaving at 121°C for 15 min. The adventitious roots were cultured in bioreactor with various treatment (batch, batch with buffer, continuous, continuous with buffer). NaHCO<sub>3</sub> was used as buffer in this study. Aeration volume was established at 0.2 vvm (volumes of gas per volume of liquid per minute) and the initial inoculum density 2 g/350 mL. Bioreactor was modified with net in middle to support growth of adventitious root.

#### *Determination of fresh and dry biomass*

The cultures were maintained for 35 days and sampling has done for every seven days to determine the total sugar, electrical conductivity (EC) and hydrogen ion concentration (pH) of the medium. All the cultures were maintained at 25 ± 2°C, with a 16 hour light (40 μmol m<sup>-2</sup> s<sup>-1</sup>) / 8 hour dark photoperiod cycle provided by 40-W white fluorescent tubes. After five weeks, the adventitious was harvested and separated from the medium through a stainless steel sieve. The fresh biomass was recorded after blotting away the surface water. The dry biomass was measured after drying root at 60°C for 48 hour.

#### *Determination of total sugar, conductivity and hydrogen ion concentration*

Measurement has conducted to liquid MS medium supplemented 2 ppm IBA. The electrical conductivity (EC) was measured using a conductivity meter (Ezdo, Cond5021), total sugar was measured using a refractometer (Atago) and the hydrogen ion concentration (pH) of the culture medium was measured using a pH meter (Boeco, BT-600) at first week until fifth weeks.

#### *Statistical analysis*

Fresh and dry biomass data was analysed using SPSS software (v.17). Mean separation within column by Independent sample T-test at P ≤ 0.05.

## **Result and Discussion**

#### *Batch and Continuous System*

Based on data, fresh biomass and dry biomass in continuous system with buffer obtain 7.80 g and 0.36 g respectively (Table 1). This result is higher than continuous (5.15 g fresh biomass and 0.22 g dry biomass), batch (4.32 g fresh biomass and 0.27 g dry biomass) and batch with buffer (4.32 g fresh biomass and 0.19 dry biomass). As shown in Table 1, the greatest response in terms of biomass production in continuous with buffer of NaHCO<sub>3</sub>. In this results on the positive effects of IBA on adventitious root growth agree with those reported by Cui *et al.* (2010) and Wu *et al.* (2006).

Using of auxin were required for the maintenance of plant cell and tissue culture technique, which were associated with the promotion of growth, rooting, callus proliferation, and morphological diversity. This study has shown that all treatment provide response of adventitious root when 2 mgL<sup>-1</sup> auxin (IBA) was added in the medium. In similar, research of Kim *et al.* (2003) reported that IBA was more effective than NAA in promoting dry mass accumulation of *P. ginseng*. The highest root dry mass was accumulated using media supplemented with IBA rather than NAA in a *Karwinskia* adventitious root culture. The roots cultured with 5.0 and 7.0 mg L<sup>-1</sup> IBA were long (>1.0 cm) and numerous (>10), whereas the roots cultured with 5.0 mg L<sup>-1</sup> NAA were thicker, less numerous and very short (Lulu *et al.*, 2015). Besides, buffer of NaHCO<sub>3</sub> was added into batch and continuous system shown the highest fresh and dry biomass (Table 1).

Sodium bicarbonate (NaHCO<sub>3</sub>) causes a high buffer capacity in the cell culture medium and keeps the pH value in the physiological area during cultivation (Freshney, 1992). The required CO<sub>2</sub> concentration is related to the desired pH-value. The carbon dioxide and bicarbonate buffering system was most commonly used to maintain of pH. The bicarbonate was a weak buffer with a pKa of 6.1 making a pH range of 7.2-7.6 more difficult to prevent rapid pH changes. This buffer, however, was non-toxic and has nutritional value (Davis 1994). The inoculum density was found to have profound influence on the growth of roots. Praveen and Murthy (2010) and Lee *et al.*, (2011) explained that inoculum density is an important parameter affecting the performance of suspended plant cells, tissues and organ cultures and accumulation of biomass productivity. In similar, Baque *et al.*, (2013) reported that inoculum density significantly affected the accumulation of root biomass of *M. citrifolia* during 4 week of culture. In this study, initial inoculum was established at 2 mgL<sup>-1</sup> (Table 1). That inoculum is suitable to generate optimum adventitious root biomass *T. paniculatum* in bioreactor.

**Table 1.** Number of root at four treatments (continuous + buffer, continuous, batch + buffer, batch) for five weeks in bioreactor containing MS liquid medium with 2 mgL<sup>-1</sup> IBA

Treatments	Initial inoculums (g)	Fresh biomass (g) (Mean ± SD)	Dry biomass (g) (Mean ± SD)
Continuous + Buffer	2.02	7.80 ± 0.30	0.36 ± 0.06
Continuous	2.04	5.15 ± 0.47	0.22 ± 0.03
Batch + Buffer	2.07	5.96 ± 1.07	0.27 ± 0.01
Batch	2.01	4.32 ± 0.02	0.19 ± 0.03

Data represents mean values (n=2) with two replicates. Mean separation within column by Independent sample T-test at P ≤ 0.05

Sajc *et al.*, (2000) in their review that fundamental studies of bioreactors with plant cells involve three important scientific and practical issues related to bioreactor design and operation such as assessment of cell growth and product formation, analysis and modeling of the culture dynamics, and studies of flow, mixing and mass transfer between the phases, in order to define criteria for bioreactor design and scale up. Sivakumar (2005) added the bioreactor culture system was more advanced than the traditional tissue culture because the bioreactor culture can be optimized by on-line manipulation of temperature, oxygen, pH, carbon dioxide and nutrients in the medium. Nutrient uptake of roots can be enhanced by continuous medium circulation. Furthermore, cell proliferation and regeneration rates can be increased. Therefore, production cost and time can be reduced substantially, quality of product can be standardized and controlled, products can be free of pesticide contamination and production can be conducted all year round without constraints of geographical. The high-tech bioreactor technology was useful for the large scale cultivation for biopharmaceuticals from plant roots. Paek *et al.* (2005) also reported bioreactor methodologies for adventitious root cultures also have to be developed. Sivakumar (2006) also described bioreactor culture was the key step towards commercial production of therapeutics by plant biotechnology. The cultivation of adventitious and hairy roots in the bioreactor that supports efficient nutrition of cells, possibly combined with the application of mechanical stimulation to direct cellular activity, differentiation and function.

In this present study, aeration volume was 2 vvm. That aeration has shown positive response to provide oxygen for growth of adventitious root. All treatment of bioreactors were not appear foaming. Sajc *et al.* (2000) reported that oxygen needs to be supplied throughout the cultivation. Since the volumetric productivity of high-viscosity and high-density cell suspensions was generally proportional to cell concentration,

which in turn limited by oxygen supply, aeration was a major concern in bioreactor design and scale up for plant cell culture. The rate of gas exchange has to be determined to provide sufficient supply of oxygen while preventing excessive removal of CO<sub>2</sub> and essential volatiles from the system. The high aeration may lead to severe foaming, which has considerable influence on the cell growth and secondary metabolite production (Zhong *et al.*, 1992). Foaming of plant cell suspensions has been correlated with aeration rates and extracellular protein concentrations (Wongasmuth and Doran, 1994). The high oxygen levels near the surfaces of the roots may become toxic to peripheral cells and cause localized oxidative stress (Shiao *et al.*, 2000).

Baque *et al.* (2013) reported that aeration volume in the bioreactors is an important factor which control the accumulation of biomass and production of metabolites, because it was mean for biomass circulation and provides essential gaseous composition of the medium. Study of Wu *et al.* (2007) for *Echinacea purpurea*, an aeration rate of 0.1 vvm was optimal for enhancing adventitious root growth compared with a high aeration rate. Similarly, cell growth of *Gymnema sylvestre* was also enhanced by a 0.1 vvm aeration rate compared to a 0.3 vvm aeration rate (Lee *et al.* 2006). In bioreactor culture, a gradual increase in aeration rate is often favorable to cell growth because the high inflows of air agitate the cells, thereby elevating the oxygen concentration in the culture, resulting in accelerated cell growth (Lee *et al.* 2011).

Study of Sajc *et al.*, (2000) reported the magnitudes of hydrodynamic forces associated with mixing should be low enough not to cause cell death, but sufficient to stimulate selected cell functions. In well mixed bioreactors, hydrodynamic effects are caused by the time and space fluctuations in liquid velocity and pressure that are associated with viscous dissipation of turbulent eddies. Besides, hyperhydricity is often associated with liquid culture and was detected in some studies concerning continuous immersion bioreactor systems (Chakrabarty *et al.*, 2007; Shaik *et al.*, 2010). Many studies used the concept of a critical shear stress, above which cell viability is lost. For laminar flow conditions, Vogelmann *et al.* (1978) suggested a critical shear stress between 80 and 200 N/m<sup>2</sup>. Sajc *et al.* (2000), reported that shear levels which are below levels causing cell damage while still high enough for efficient mixing in the liquid phase and dispersion of air are considered as important criteria of bioreactor design. Shear sensitivity was perceived to hydrodynamic stress associated with aeration and agitation. The presence of thick cellulose based cell wall, and existence of large vacuoles. The immediate consequence of the shear effect on plant cells is cell damage, which has been quantitatively measured by using a number of system responses such as reduction in cell viability (Scragg *et al.* 1988), release of intracellular compounds (Meijer *et al.* 1993), changes in morphology and aggregate patterns (Kieran *et al.* 1995), and changes in metabolism (Zhong *et al.* 1994).

In this study, however, the production of roots did not present symptoms of hyperhydricity. It has observed and suitable with many studies in Hahn and Paek, (2005), Jo *et al.* (2008) and Mariateresa *et al.* (2014). For reduce hyperhydricity of adventitious root cells, in this study used net at middle in bioreactor. The net has benefit to avoid hyperhydricity and support the plant mass has certainly contributed to prevent this phenomenon ensuring a constant aeration of explants and leading to good growth of roots (Paek *et al.*, 2005). In figure 2 have resulted fresh biomass and dry biomass of the all treatments (batch, batch with buffer, continuous and continuous with buffer). Morphology of *T. Paniculatum* adventitious roots have shown the same texture and color. All treatments have thick root in texture and brown in color. The highest accumulation of adventitious root biomass in fresh and dry has found on continuous system with buffer (figure 2d and 2h).

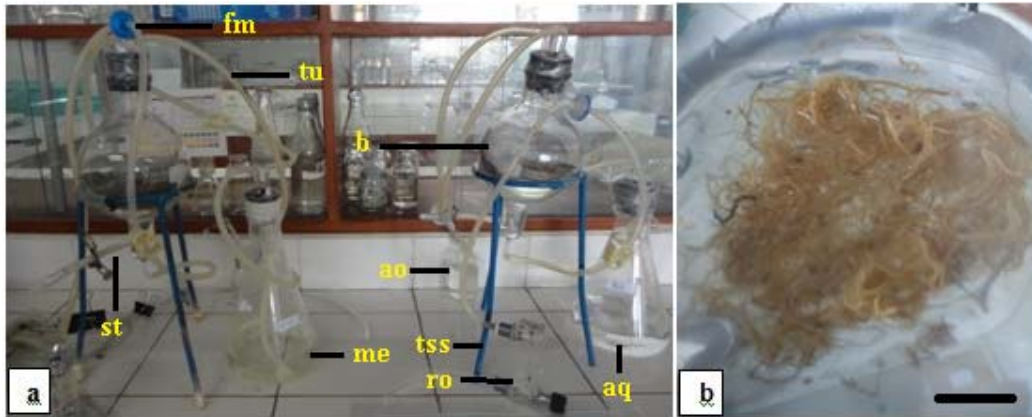

**Figure 1.** Adventitious root culture of *T. paniculatum* Gaertn. in balloon type bubble bioreactor : a) bioreactor with continuous and batch system; b) culture process. b- bioreactor; fm-filter membrane; tu-tube; ao-air out; st-sample tube; me-medium; tss-triangle stainless steel; ro-rotatometer; aq-aquades. (Bar = 2 cm)

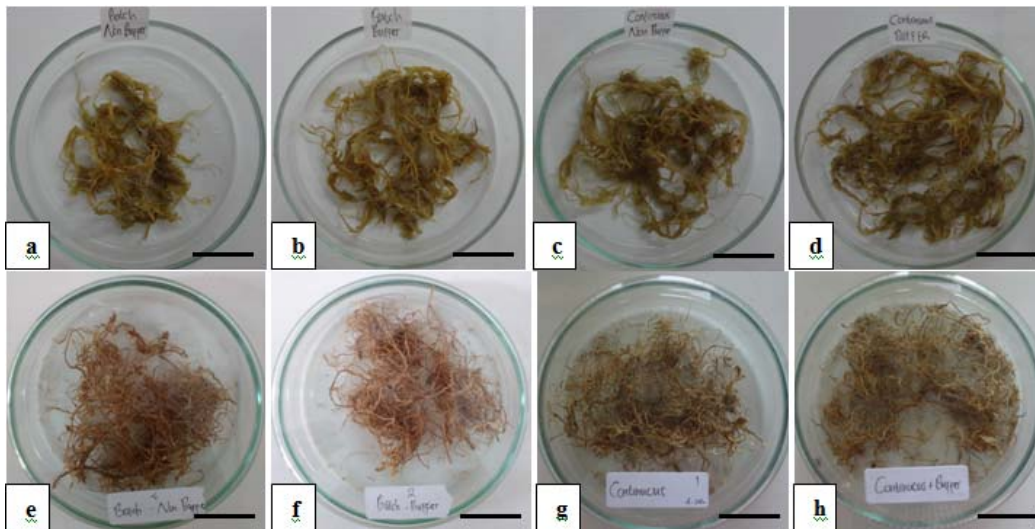

**Figure 2.** Adventitious root of *T. Paniculatum* Gaertn. : a-d) fresh biomass in batch, batch+buffer, continuous, continuous+buffer; e-h) dry biomass in batch, batch+buffer, continuous, continuous+buffer. (Bar = 1.5 cm)

Various of treatments such as batch and continuous system have considered in this present study. In batch system, periodically in two weeks that medium was added sterile distillate water but it was not added new medium. Meanwhile, in continuous system that medium was added new medium (MS) periodically. Similarly, Sajc *et al.* (2000) explained that batch cultivations were characterized by constantly changing environmental conditions, and are capable of producing metabolites associated with any kinetic pattern. Batch studies were used to determine the conditions for maximum productivity. In contrast, continuous flow reactor with cell recycle was a flexible cultivation system. For a very low cell recycle this system approaches a chemostat, while for a complete cell recycle the system approaches immobilized cell culture suitable for production of non-growth associated products. Continuous flow with complete cell recycle was often referred to as a perfusion culture. Various models for culturing plant cells have been employed in suspension culture in order to maximize product formation. Steady state continuous flow operation, with a constant withdrawal of culture medium

and cells is commonly used for the production of growth associated products, typically primary metabolites and biomass. The continuous culture technique has also been adopted for the cultivation of several plant cells such as, *Coptis japonica* (Matsubara *et al.* 1989), *Catharanthus roseus* (Park *et al.* 1990), and *Nicotiana tabacum* (Hashimoto *et al.* 1982).

*Total sugar, conductivity and hydrogen ion concentration in the medium*

Determination of hydrogen ion concentration (pH), total sugar and electrical conductivity (EC) of the médium was conducted every seven days. Basically, total sugar, pH and EC had decreased, but increased by using buffer of NaHCO<sub>3</sub> every two weeks (figure 3). The total sugar value in batch system are different with continous system which was provided new medium in 14 days and 28 days. Meanwhile, pH in batch and continuous without buffer decreased until 35 days, except on batch and continuous with buffer periodically in two weeks increased in 14 days and 28 days. For electrical conductivity in the all treatments decreased and increased when was added buffer each two weeks.

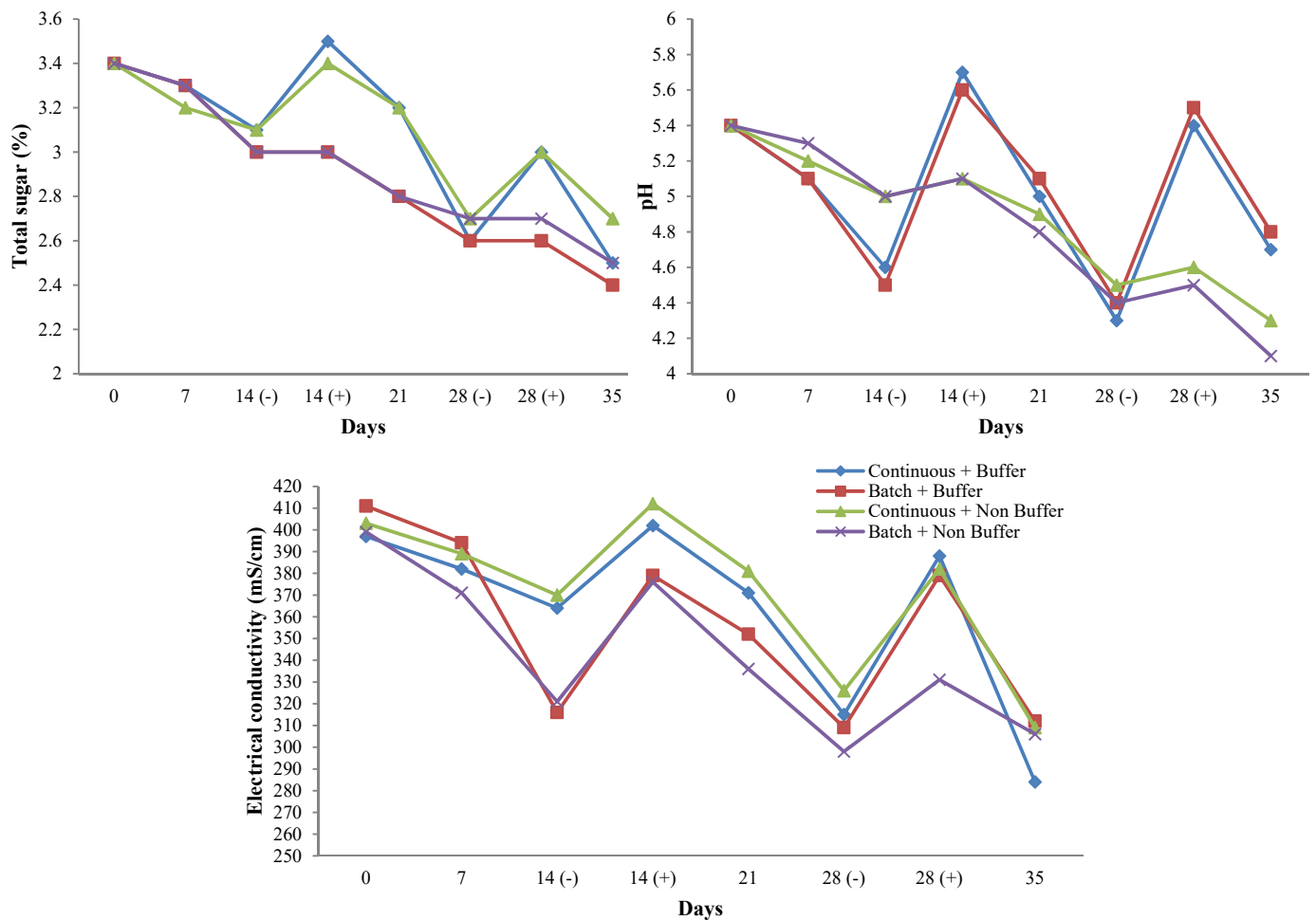

**Figure 3.** Adventitious root culture condition for 35 days. Culture condition change in (A) hydrogen ion (pH); (B) Total sugar; (C) Electrical conductivity (EC). (-) before added buffer and (+) after added buffer.

Several studies described that liquid medium was examined by electrical conductivity, pH and total sugar. The high conductivity of medium showed that the adventitious root unavailable to absorb inorganic compounds. In study of Mariateresa *et*

*al.* (2014) reported that sucrose availability in liquid medium (bioreactor). Adelberg *et al.* (2010) also reported that findings of sucrose availability in liquid medium higher than in gelled medium. It has known that sucrose as energy source and important carbon for plant cells growth. Gertlowski and Petersen (1993) explained that it can also affect metabolism of the cells and production of metabolites. Lee *et al.* (2006) reported that sucrose is hydrolyzed into two monosaccharides, glucose and fructose, by invertase which bounds extracellular or cell wall during the initial culture period. Meanwhile, electrical conductivity (EC) values of the residual media progressively increased with increasing salt strength of the culture medium, whereas pH values progressively decreased. The EC values of the residual media reflect the uptake of ions by roots and represent an indirect method of biomass estimation (Baque *et al.*, 2013; Cui *et al.*, 2010). In plant tissue culture, pH is an important factor affecting biomass and secondary metabolite accumulation. For instance, in root suspension cultures of ginseng, root dry biomass and ginsenoside accumulation were strongly inhibited when pH was maintained below 4.0 or above 7.0 (Hahn *et al.*, 2003). Wu *et al.*, 2006 also reported that the growth of *Echinacea* roots decreased when pH was maintained below 5 or above 6. Lulu *et al.* (2015) explained that in their study after 7 weeks of culture, the pH of the medium declined as the  $\text{NH}_4^+$  level increased. The EC measurements have been used as an indirect method for biomass estimation during the continuous online monitoring of nutrient uptake in plant cell culture bioprocess engineering because of their accuracy and efficiency.

## Conclusions

In this study, we have successfully established adventitious root cultures of *T. paniculatum* 1 L capacity bioreactors containing 350 mL medium and worked out various treatments (continuous + buffer, continuous, batch + buffer, batch). Treatment of continuous system with buffer of  $\text{NaHCO}_3$  has shown fresh biomass (7.80 g) and dry biomass (0.36 g) higher than the others. That treatment has produced biomass four fold of initial inoculum. The continuous system provide biomass production better than the others and supplemented of buffer ( $\text{NaHCO}_3$ ) influence biomass productivity.

## Acknowledgements

Thanks to Indonesia Endowment Fund for Education (LPDP), Ministry of Finance, Republic of Indonesia and Plant Physiology Laboratory at Departement of Biology, Faculty of Science and Technology, Airlangga University.

## References

- Adelberg, J. W., Delgado, M. P. and Tomkins, J. T. (2010). Spent medium analysis for liquidculture micropropagation of *Hemerocallis* on Murashige and Skoog medium, *In Vitro Cell. Dev. Biol. Plant* Vol. 46, No. 1, pp.95–107.
- Baque, M. A., Shiragi, M. H. K., Moh, S. H., Lee, E. J. and Paek, K. Y. (2013). Production of biomass and bioactive compounds by adventitious root suspension cultures of *Morinda citrifolia* (L.) in a liquid-phase airlift balloon-type bioreactor. *In Vitro Cell. Dev. Biol.*, Vol. 49, pp.737–749.
- Choi, S. M., Son, S. H., Yun, S. R. and Paek, K. Y. (2000). Pilot-scale culture of adventitious roots of ginseng in a bioreactor system. *Plant Cell Tiss. Org. Cult.*, Vol. 62 pp.187–193.
- Cui, X. H., Chakrabarty, D., Lee, E. J. and Paek, K. Y. (2010). Production of adventitious roots and secondary metabolites by *Hypericum perforatum* L. in a bioreactor. *Bioresour. Technol.*, Vol. 101, pp.4708–4716.
- Cui, H. Y., Murthy, H. N., Moh, S. H., Cui, Y. Y., Lee, E. J. and Paek, K. Y. (2014) Production of biomass and bioactive compounds in protocorm cultures of *Dendrobium*

- candidum* Wall ex Lindl. Using ballon type bubble bioreactors. *Ind. Crops and Products*, Vol. 53, pp.28-33.
- Davis, J. M. (1994) ed. *Basic Cell Culture: A Practical Approach*. p.59-60. New York: Oxford University Press.
- Freshney, R. I. (1992) ed. *Animal Cell Culture: A Practical Approach*. 2nd ed. p.54. New York: Oxford University Press.
- Gertlowski, C. and Petersen, M. (1993). Influence of the carbon source on growth and androsmarinic acid production in suspension cultures of *Coleus blumei*. *Plant Cell Tissue Org. Cult.*, Vol. 34, No.2, pp.183-190.
- Hahn, E. J. and Paek, K.Y. (2005). Multiplication of Chrysanthemum shoots in bioreactors as affected by culture method and inoculation density of single node stems. *Plant Cell Tissue Org. Cult.*, Vol.81, pp.301-306.
- Hahn, E. J., Kim, Y. S., Yu, K. W., Jeong, C. S. and Paek, K. Y. (2003). Adventitious root cultures of *Panax ginseng* C. V. Meyer and ginsenoside production through large-scale bioreactor system. *J. Plant. Biotechnol.*, Vol. 5, pp.1-6.
- Hashimoto, T., Azechi, S., Sugita, S. and Suzuki, K. (1982). Large scale production of tobacco cells by continuous cultivation. In: A. Fujiwara (ed). *Plant Tissue Culture*, p.403-404. Tokyo: Japan Association of Plant Tissue Culture.
- Jo, E. A., Murthy, H. N., Hahn, E. J. and Paek, K. Y. (2008). Micropropagation of *Alocasia amazonica* using semisolid and liquid cultures. *In Vitro Cell. Dev. Biol. Plant.*, Vol. 44 No. 1, pp.26-32.
- Kieran, P. M., O'Donnell, H. J., Malone, D. M. and MacLoughlin P. F. (1995). Fluid shear effects on suspension cultures of *Morinda citrifolia*. *Biotechnol. Bioeng.*, Vol. 45, pp.415- 425.
- Kim, Y. S., Hahn, E. J., Yeung, E. C. And Paek, K. Y. (2003). Lateral root development and saponin accumulation as affected by IBA or NAA in adventitious root cultures of *Panax ginseng* C.A. Meyer. *In Vitro Cel. Develop. Biol. – Plant.*, Vol. 39, pp.245-249.
- Lee, E. J., Moh, S. H. and Paek K. Y. (2011). Influence of inoculum density and aeration volume on biomass and bioactive compound production in bulb-type bubble bioreactor cultures of *Eleutherococcus koreanum* Nakai. *Bioresour. Technol.*, Vol. 102, pp.7165-7170.
- Lee, E. J., Mobin, M., Hahn, E. J. and Paek, K. Y. (2006). Effect of sucrose, inoculums density, auxins, and aeration volume on cell growth of *Gymnema sylvestre*. *J. Plant Biol.* Vol. 49, pp.427-431.
- Lulu, T., Park, S. Y., Ibrahim, R. and Paek, K. Y. (2015). Production of biomass and bioactive compounds from adventitious roots by optimization of culturing conditions of *Eurycoma longifolia* in ballon-type bubble bioreactor sistem. *J Biosci and Bioeng.*, Vol. 119, No. 6, pp.712-717.
- Manuhara, Y. S. W., Kristanti, A. N. and Utami, E. S. W. (2015). Optimization of Culture Conditions of *Talinum paniculatum* Gaertn. Adventitious Roots in Balloon Type Bubble Bioreactor Using Aeration Rate and Initial Inoculum Density. *Asian Journal of Biological Sciences* Vol. 8, No. 2, pp.83-92.
- Mariateresa, C., Maria, C. S. C. and Giuseppe, C. (2014). Influence of ozone treatments on in vitro propagation of *Aloe barbadensis* in continuous immersion bioreactor. *Industrial Crops and Products*, Vol. 55, pp.194-201.
- Matsubara, K., Kitani, S., Yoshioka, T., Morimoto, T., Fujita, Y. and Yamada, Y. (1989). High density culture of *Coptis japonica* cells increases berberine production. *J. Chem. Technol. Biotechnol.*, Vol. 46, pp.61-69.
- Meijer, J. J., ten Hoopen, H. J. G., Luyben, K. C. A. M. and Libbenga K. R. (1993). Effects of hydrodynamic stress on cultured plant cells: a literature survey. *Enzyme Microb. Technol.*, Vol. 15, pp.234-238.
- Murashige, T. and Skoog, F. (1962). A revised medium for rapid growth and bio assays with tobacco tissue cultures. *Physiologia Plantarum*, Vol. 15, pp.473-497.

- Paek, K. Y., Murthy, H. N., Hahn, E. J. and Zhong, J. J. (2009). Large scale culture of ginseng adventitious roots for production of ginsenosides. *Adv. Biochem. Eng. Biotechnol.*, Vol. 113, pp.151–176.
- Paek, K. Y., Chakrabarty, D. and Hahn, E. J. (2005). Application of bioreactor systems for large-scale production of horticultural and medicinal plants. *Plant Cell Tissue Organ Cult.*, Vol. 81, pp.287–300.
- Park, H. H., Choi, S. K., Kang, J. K. and Lee, H. Y. (1990). Enhancement of producing catharanthine by suspension growth of *Catharanthus roseus*. *Biotechnol. Lett.* Vol. 12, pp.603-608.
- Praveen, N. and Murthy, H. N. (2010). Establishment of cell suspension cultures of *Withania somnifera* for the production of withanolide A. *Bioresour. Technol.* Vol. 101, pp.6735–6739.
- Sajc, L., Grubisic, D. and Novakovic, G. V. (2000). Bioreactors for plant engineering: an outlook for further research. *Biochem. Engineer. J.*, Vol. 4, pp.89–99.
- Scragg, A. H., Allan, E. J. and Leckie, F. (1988). Effect of shear on the viability of plant cell suspensions. *Enzyme Microb. Technol.*, Vol. 10, pp.361-367.
- Shaik, S., Dewir, Y. H., Singh, N. and Nicholas, A. (2010). Micropropagation and bioreactor studies of the medicinally important plant *Lessertia* (*Sutherlandia frutescens* L. S. Afr. J. Bot., Vol. 76, pp.180–186.
- Shiao, T. and Doran, P.M. (2000). Root hairiness: effect on fluid flow and oxygen transfer in hairy root cultures. *J. Biotechnol.*, Vol. 83, pp.199–210.
- Sivakumar, G. (2006). Bioreactor technology: A novel industrial tool for high-tech production of bioactive molecules and biopharmaceuticals from plant roots, *Biotechnol. J.*, Vol. 1, pp.1419–1427.
- Sivakumar, G., Yu, K. W. and Paek, K. Y. (2005). Biosafe ginseng: A novel source for human well being. *Eng. Life Sci.*, Vol. 5, pp.527–533.
- Vogelmann, H., Bischof, A., Pape, D. and Wagner, F. (1978). Some aspects of mass cultivation, in: A.W. Alfermann, E. Reinhard (Eds.), *Production of Natural Compounds by Cell Culture Methods*, pp.130–146. Munich: GSF.
- Wongasmuth, M. and Doran, P. M. (1994). Foaming and cell floatation in suspended plant cell cultures and the effect of chemical antifoams. *Biotechnol. Bioeng.*, Vol. 44, pp.481-488.
- Wu, C. H. Murthy, H. N., Hahn, E. J. and Paek K. Y. (2007). Enhanced production of caftaric acid, chlorogenic acid and cichoric acid in suspension cultures of *Echinacea purpurea* by the manipulation of incubation temperature and photoperiod. *Biochem Eng J.*, Vol. 36, pp.301–303.
- Wu, C. H., Dewir, Y. H., Hahn, E. J. and Paek, K. Y. (2006). Optimization of culturing conditions for the production of biomass and phenolics from adventitious roots of *Echinacea angustifolia*. *J. Plant Biol.*, Vol. 49, pp.193–199.
- Yu, K. W., Gao, W. Y., Hahn, E. J. and Paek, K. Y. (2001). Effects of macro elements and nitrogen source on adventitious root growth and ginsenoside production in ginseng (*Panax ginseng* C.A. Meyer). *J. Plant Biol.* Vol. 44, pp.179–184.
- Zhong, J. J., Seki, T., Kinoshita, S. and Yoshida, T. (1992). Effects of surfactants on cell growth and pigment production in suspension cultures of *Perilla frutescens*. *World J. Microbiol. Biotechnol.*, Vol. 8, pp.106-109.
- Zhong, J. J., Fujiyama, K., Seki, T. and Yoshida, T. (1994). A quantitative analysis of shear effects on cell suspension and cell cultures of *Perilla frutescens* in bioreactors. *Biotechnol. Bioeng.*, Vol. 44, pp.649-654.
- Zolman, B. K., Yoder, A. and Bartel, B. (2000). Genetic analysis of indole-3-butyric acid responses in *Arabidopsis thaliana* reveals four mutant classes. *Genetics*, Vol. 156, pp.1323–1337.



---

**Leaf Callus Induction of *Moringa oleifera* with Addition Various  
Concentration Naphthalene Acetic Acid (NAA) and N<sup>6</sup>-  
furfuryladenine (Kinetin) in MS Medium in vitro**

Muhammad Evan N<sup>a</sup>, Erlyta Vivi P<sup>b</sup>\*

<sup>a,b</sup>*Institut Teknologi Sepuluh Nopember, Kampus ITS Sukolilo, Surabaya 60111, Indonesia*

<sup>b</sup>*Second affiliation, Address, City and Postcode, Country*

---

**Abstract**

*Moringa oleifera* is the plants which have high nutritional content of minerals and vitamins. In Indonesia, the cultivation of *M. oleifera* still utilizing vegetative propagation. Therefore, the resulting seedlings are limited and have a low quality of seeds. To solve the problems, rapid *M. oleifera* propagation and sustainable high quality of seeds through in-vitro culture are needed. This study aimed to determine the effect of somatic embryogenesis induction of *M. oleifera* leaves due to the adding variation of plant growth regulators concentration of Naphthalene Acetic Acid (NAA) and Kinetin in MS medium in-vitro. This study was conducted using a completely randomized design with four treatments, are M1 (MS 0), M2 (MS + NAA 0.5 mg/L + Kinetin 1 mg/L), M3 (MS + NAA 1 mg/L + Kinetin 1 mg/L), and M4 (MS + NAA 1 mg/L + Kinetin 0.5 mg/L) and there were three replication of each treatments. Parameters observed that were the rate of induction time, color and texture of callus. Data were analyzed using analysis of descriptive. The results showed that the addition of plant growth regulators NAA and Kinetin at various concentration affected callus growth of *M. oleifera* leaves on MS medium in-vitro. The medium concentration of M2 (MS + NAA 0.5 mg/L + Kinetin 1 mg/L) was the optimal concentration on callus induction (on fourteenth day), the callus has white color and compact texture.

**Keywords**

callus induction; kinetin; *Moringa oleifera*; Naphthalene Acetic Acid (NAA)

---

**1. Introduction**

*Moringa oleifera* is one of the most popular plants belonging to the family of *Moringaceae* (Saini et al., 2012). *M. oleifera* has unique characteristics which attract such toughness tree, easily propagated, and resistant to drought with very low growth's requirements regard with nutrients, water, and its management which these plants play an important role also in the utilization field of medicine and nutrition (Magana, 2012). *M. oleifera* is one of the promising commodity in the food sector for its rich nutrients and minerals as well as the ability of trees to produce leaves with maximum condition even

---

\* Corresponding author. Tel.: +62-857-581-37306  
E-mail address: muhammadevan12@gmail.com

at the end of the dry season when other food sources are rarely to be found (Fuglie, 1999). Every part of the *M. oleifera* tree has a strong activity as pharmaceuticals. Such as their leaves, roots, seeds, bark, fruit, pods, and flowers act as a stimulant of the heart and blood circulation, antitumor pyretic, anti-epileptic and anti-inflammatory (Kumar et al., 2010), antiulcer, antipasmodic, diuretics, anti-hypersensitive, cholesterol lowering, antioxidant, antidiabetic, hepato-protective, antibateri and anti-fungal, and some other treatments of different diseases (Anwar et al., 2007). In Africa, *M. oleifera* is used as a food enhancer prenatal nutrition in pregnant women (Amin et al., 2007), as well as a program of food sovereignty in Africa and India. *M. oleifera* as a way to combat malnutrition because it contains high vitamins, proteins and minerals. In addition, *M. oleifera* seeds can be used to purify water (Diatta, 2001) The study further stated that the purification of water not only reduces solid contaminants, but rather the overall harmful bacteria contained in the water.

In Indonesia, the cultivation of *M. oleifera* has not been done and only based on vegetative propagation (grafting or cuttings) and generative (seeds) so the limitations of seeds as planting materials often occur. Planting with an area of approximately 500,000 hectares to fulfill the demand requires 5 billion seedlings (Jahn, 1986). Limitations of the seedlings should be has an appropriate, economical, and efficient propagation solution.

The most appropriate method to apply is utilize tissue culture techniques by taking part of the *M. oleifera* plant which is not limited to the seed then carried regeneration initiation of embryogenesis, starts induction of somatic embryos for reproduction purposes. Tissue culture itself is the cultivation of a plant tissue (explants) into complete plants with properties like its parent which explants will be wrapped with a special wrapper that makes explant is not easily damaged and can grow well (Marfori, 2010). The combination of Kinetin and NAA as plant growth regulator (PGR) plays an important role in in-vitro culture to stimulate growth of certain cells or tissues that have not differentiated. So we need further study to determine the right combination PGR for maximum growth of explants especially *M. oleifera* leaf explants.

This study aimed to describe the effect of somatic embryogenesis induction of Moringa leaves due to the addition of various concentrations of growth regulators Napthalene Acetic Acid (NAA) and N<sup>6</sup>-furfuryladenine (Kinetin) on MS medium in-vitro.

## **2. Materials and Methods**

### *2.1. Sterilization of Explants*

The study was conducted in April 2016 at the Laboratory of Plant Bioscience and Engineering, Department of Biology, Faculty of Mathematics and Natural Science, Institut Teknologi Sepuluh Nopember.

Explants used are Moringa leaf. Sterilization of explants performed in several stages. The first stage is the tools that have been sterilized prepared in LAF. The explants were washed with running water for 10 minutes, soaked in a solution of detergent for 10 minutes, soaked in a solution of clorox for 3 minutes, soaked in a solution of antifungal for 10 minutes, soaked in alcohol 70% for 3 minutes, and then transferred into a glass beaker sterile inside LAF room and soaked in sterile distilled water for 3 minutes.

## 2.2. Condition of Culture

The explants were cultured in Murashige and Skoog (MS) (Arismarsetiowati, 2012) medium with 3% sucrose, pH of the medium around 5.7 to 5.8 and then incubated in a dark room with temperature 22-25°C. The explants were cultured for 30 days to form a callus. NAA and Kinetin treatment combinations are as follows:

Table 1. Various medium concentration

medium	Concentration
M1	MS 0
M2	MS + NAA 0.5 mg/L + Kinetin 1 mg/L
M3	MS + NAA 1 mg/L + Kinetin 1 mg/L
M4	MS + NAA 1 mg/L + Kinetin 0.5 mg/L

## 2.3. Data Analysis

Observation conducted during 30 days to form a callus. Observation data includes the rate of callus induction, texture and color of callus analyzed descriptively.

## 3. Results and Discussions

Study on somatic embryogenesis *Moringa oleifera* by the addition of various concentrations of NAA and Kinetin on MS medium in-vitro showed an induction of callus. According to (Murashige and Skoog, 1962), the callus is initiated through in-vitro method by putting the plant tissue slices called explant on the medium in a sterile condition.

The parameters of experiment include the rate of callus induction, color and texture of callus. The rate calculation of callus induction is done from the first of inoculation until the callus of *Moringa* is emerge within the period of observation for 30 days. The color and texture of the callus was observed through physical changes that occur in the growth of *Moringa* leaf explants.

medium	Average rate (days)	Color	Texture
M1	0	-	-
M2	14	White	Compact
M3	0	-	-
M4	0	-	-

The result of callus induction showed that callus emerge only in the medium's treatment of M2 with an average rate of callus induction on the 14th day. While the medium's treatment of M1, M3 and M4 do not indicate the presence of callus.



**Figure 1. The result of callus induction on the lateral part of Moringa leaf explants in M2 medium (black circle)**

The texture of callus on M2 medium is compact and has a white color. Likewise with other medium explant white although not induced callus.

Based on reference (George and Paul, 2008), a variation of PGR with a ratio of NAA : Kinetin (0.5:1) shows the best variation of PGR to encourage the growth of callus induction from Moringa leaf explants. Growth of callus formed at the edge of the explant (part of the injury) is in direct contact with the medium called the Callogenesis (Fatima and Perveen, 2016). This is because the process making of medium nutrient by explant. The absorption of nutrients will be better if direct contact between the medium with the abaxial leaves. The emergence of callus on the injured due to the stimulation of tissue in the explants to cover the wound. Cell division that leads to the induction of callus occurred on their response to cuts and supply natural or artificial hormones from the outside in explants (Robbiani et al., 2010).

NAA role in stimulating the growth of callus, root, division cell, elongation cell, the organs and stimulate the apical dominance in meristem tissue with a certain combination with other PGR (George and Sherrington, 1993). Kinetin acts as a synthetic compound of cytokines hormones that play a role in the increase of induction and development of plants (Dwimahyani, 2005). The high activity of cytokines than the auxin with lower concentrations can induce the embryogenic callus induction (Yamamoto et al., 2012).

In the treatment of M1 medium does not appear any callus. According to (Purnamaningsih, 2006), the factors influencing the growth of explants are the type and the concentration of used growth regulators. If there is no additional PGR, so there is no stimulation to trigger the induction of callus.

In the treatment of M3 and M4 medium did not show the induction of callus due to variations in the concentration of PGR between NAA and Kinetin that do not fit in inducing callus (Yamamoto et al., 2012). Explants have the ability to produce endogenous auxin. The addition of high auxin in the culture medium causes disproportionate interaction with endogenous auxin and therefore can not induce the callus (Lidyawati et al., 2012). Auxin hormones induces the secretion of H<sup>+</sup> ions out of

the cell through the cell wall. Acidification of the cell wall causing K<sup>+</sup> ions are taken to reduce the potential water and cells, as a result of water into the cells and the cells to swell. Auxin also influences the metabolism of RNA and protein metabolism through transcription (Rahmaniar, 2007).

The formed callus has a compact texture and white color. The compact texture illustrates the power of regeneration to form shoots and root. According to (Amin et al., 2007), callus be able to has compact texture if the cell or another part of cells do not easily separated and the texture is hard (Gunawan, 1988). The texture of compact callus is the effect of cytokinin and auxin affects the water potential inside the cell. Auxin will loosen the fibers of the cell wall, making the cell walls more flexible and nutrients contained in the medium will diffused. This will continue until the water potential and osmotic potential balanced and cells become turgid. Turgid cells with the addition of cytokines will influence the division and elongation cell so that the induction of the cell wall more quickly and be compact callus.

The white color of callus caused by the absence of light on the placement of a culture bottle in dark room. It aims to accelerate the growth of explants. According to (Evans et al., 2003), the lack of light during the development of plant will cause etiolation symptoms, which the stem will grow faster but weak and the leaves are small, thin and pale (not green). Etiolation symptoms are caused by a lack of light or the plants are in a dark room.

The white color of callus has not contain chloroplasts, but it contains starch granules which is a polysaccharide deposits in plants. Lighting factors also play a role in the induction of callus. The color change that occurs in callus due to the pigment and is affected by nutritional and environmental factors such as light (Gunawan, 1988).

#### **4. Conclusion**

The most effective concentration of plant growth regulator for callus induction of *Moringa oleifera* leaf explants was MS medium supplemented with NAA 0.5 ppm + Kinetin 1 ppm) with the average rate of callus induction on day 14.

#### **Acknowledgements**

This study was funded by Laboratory of Plant Bioscience and Engineering, Department of Biology, Faculty of Mathematics and Natural Science, Institut Teknologi Sepuluh Nopember.

#### **References**

- Saini, R.K.N.P. Shetty, P. Giridhar, G.A. Ravishankar (2012). "Rapid in-vitro regeneration method for *Moringa oleifera* and performance evaluation of field grown nutritionally enriched tissue cultured plants". *Journal of Biotech*, vol. 2, pp. 187-192
- Magana, M. (2012). "Developing a standardized in-vitro streilization method for field-grown *Moringa Oleifera* explants". A Thesis The University of Belize in Fulfillment of BIOL 4992.

- Fuglie, L.J. (1999). "The miracle tree: Moringa oleifera: natural nutrition for the tropics". Article Church World Service. Dakar.
- Kumar, P.S. Mishra, D. Ghosh, G. Panda, G.S. (2010). "Medicinal uses and pharmacological properties of Moringa oleifera". Int. J. Phytomed. vol 2, pp. 210–216.
- Anwar, F. Latif, S. Ashraf, M. Gilani, A.H. (2007). "Moringa oleifera: a food plant with multiple medicinal uses". J. Phytother. Res. 21, vol 17–25.
- Amin et al. (2007). Induksi Kalus dari Daun Nilam Kultivar Lhoksemauwe, Sidikalang, dan Tapaktuan dengan 2,4D. Zuriat. vol 18 no 2.
- Diatto, S. (2001). "Supplementation for pregnant and breastfeeding women with Moringa oleifera powder. In: Developmental potential for Moringa products". Workshop proceedings. Dar es Salaam, Tanzania.
- Jahn, S.A.A. (1986). "Proper use of African natural coagulants for rural water supplies – Study in the Sudan and a guide to new projects". GTZ Manual. vol 1, pp. 191.
- Marfori, E. (2010). "Clonal Micropropagation of Moringa oleifera L". Phillip Agric Scientist. vol. 93, no. 4, pp. 454-457.
- Arismarsetiowati, R. (2012). "Kultur Jaringan Tanaman Kopi". Pusat Penelitian Kopi dan Kakao Indonesia.
- Murashige, T. and Skoog, F. (1962). "A revised medium for rapid growth and bio assays with tobacco tissue culture. Journal Physiologia Plantarum, vol. 15.
- George, E. and Paul, S. (2008). "Plant propagation by tissue culture. England: Handbook and Directory of Commercial Laboratories.
- Fatima, H. and Perveen, A. (2016). "Micropropagation to rescue endangered plant Moringa concanensis nimmo". Pak. J. Bot vol. 48 (1), pp. 291-294.
- Robbiani, D. Nurhidayati, T. Jadid, N. (2010). "Pengaruh kombinasi NAA dan Kinetin pada kultur In-vitro eksplan daun tembakau (Nicotiana tabacum L. var. Prancak 95)". Journal Science and Technology. ITS Press.
- George, E. F. and Sherrington . (1993). "Plant propagation by tissue culture. Exegetic limited". London. 1993.
- Dwimahyani. I. (2005). "Pemuliaan mutasitanaman jarak pagar (Jatropha curcas)". Jakarta: Petir.
- Yamamoto, M. Miyoshi, K. Ichihashi, S. and Mii. M. (2012). "Ionic compositions play an important role on in vitro propagation of PLBs of spring-flowering Calanthe. Plant Biotechnology. Vol. 29 pp. 71-76.
- Purnamaningsih, R. (2006). "Induksi Kalus dan Optimasi Regenerasi Empat Varietas Padi melalui Kultur In-vitro". Jurnal AgroBiogen vol. 2 (2) pp. 74-80.
- Lidyawati, Ni Y. Waeniati, dan M. Suwastika, I N. (2012). "Perbanyak tanaman melon (Cucumis melo L.) secara in-vitro pada medium MS dengan penambahan Indole Acetic Acid (IAA) dan Benzil Amino Purin (BAP). Jurnal Natural Science. vol. 1 (1) pp. 43-52.
- Rahmaniar, A. (2007). "Pengaruh macam eksplan dan konsentrasi 2,4-D-Dichlorophenoxyacetic Acid (2,4-D) terhadap pertumbuhan Anthurium (Anthurium plowmanii Croat) pada Medium MS". Surakarta: Fakultas Pertanian UNS. 2007.
- Gunawan, L.W. (1988). "Teknik kultur jaringan tumbuhan. Bogor: Laboratorium Kultur Jaringan Tumbuhan Pusat Antar.
- Evans, D.E. Coleman, J.O.D. and Kearns, A. (2003). "Plant cell culture. New York: BIOS Scientific Publisher.

---

**THE UTILIZATION OF CaO NANOPARTICLES FROM LIMESTONE  
AS A COUNTERMEASURE EFFORT OF SO<sub>2</sub> GAS EMISSIONS  
IN PT. SEMEN PADANG USING COPRECIPITATION METHOD**

**Arif Munandar<sup>a</sup>, Randi Proska Sandra<sup>b</sup>, Yesi Marta Saputri<sup>c</sup>, Melati Putri  
Pramita<sup>d</sup>, Ananda Putra<sup>e</sup>**

*<sup>a</sup>Mining Engineering, Faculty of Engineering State University of Padang, Jl. Belibis Blok E  
13 Air Tawar Barat, Padang 25131, Indonesia*

*<sup>b</sup>Education of Informatics Engineering, Faculty of Engineering State University of Padang,  
Jl. Belibis Blok E 13 Air Tawar Barat, Padang 25131, Indonesia*

*<sup>c</sup>Chemistry, Faculty of Mathematics & Science State University of Padang, Jl. Belibis Blok A  
12 Air Tawar Barat, Padang 25131, Indonesia*

*<sup>d</sup>Education of Chemistry, Faculty of Mathematics & Science State University of Padang, Jl.  
Gajah No 2 Air Tawar Barat, Padang 25131, Indonesia*

*<sup>e</sup>Chemistry, Faculty of Mathematics & Science State University of Padang, Jl Mustang No.8  
RT06 RW03 Tunggul Hitam, Padang 25176, Indonesia*

---

**Abstract**

Air pollution is caused by poor air quality. The increased of human activities today, especially in industry affected the air quality. For instance, cement industry that produces dust particulates and exhaust gas emissions from incineration in cement production. These exhaust gas emissions consist of sulfur dioxide (SO<sub>2</sub>), carbon monoxide (CO), carbon dioxide (CO<sub>2</sub>), nitrogen dioxide (NO<sub>2</sub>) and ozone (O<sub>3</sub>). Some efforts have been done to prevent dust waste and exhaust gas emission especially hazardous SO<sub>2</sub> from cement processing factory by using dust vacuum machine such as electrostatic precipitator (ESP). However, this effort has not been able to optimize the prevention of dust waste and gas emission pollution yet. The generated sulfur dioxide (SO<sub>2</sub>) gas will reacted with water vapour and form sulfuric acid which fell with the rainwater, causing corrosive acid rain. Alternative solution for these problems could be done by using CaO nanoparticles from limestones. Sulfuric dioxide (SO<sub>2</sub>) gas emissions be reacted with CaO nanoparticles directly (based on equilibrium thermogravimetric). This study used a qualitative descriptive and quantitative approach with several stages of research; CaO nanoparticles synthesis and particle characterization by using X-ray diffraction (XRD) and Fourier Transform Infrared (FTIR). The synthesis process of CaO nanoparticles done by using coprecipitation method and characterization with X-ray Fluorescence (XRF). CaO nanoparticles produced in this process be reacted with PT. Semen Padang's SO<sub>2</sub> exhaust gas emission and form CaSO<sub>3</sub> with various CaO to SO<sub>2</sub> absorption time; 15 minutes, 30 minutes, 60 minutes and 120 minutes. The result is the optimum absorption of SO<sub>2</sub> occurs at the 30<sup>th</sup> minutes with sulfur level (%); 0.563% in the form of elements, 1.159% in the geology, and 1.159% as oxides.

**Keywords:** SO<sub>2</sub> gas emissions; CaO nanoparticles; Coprecipitation; PT. Semen Padang

---

<sup>a</sup>arifmunanadar225@gmail.com, <sup>b</sup>randiproska@gmail.com, <sup>c</sup>yesimarta.s@gmail.com, <sup>d</sup>melati2303@gmail.com,  
<sup>e</sup>anandap@fimpa.unp.ac.id

## 1. Introduction

Air is one of the most important elements of life, compared to drinks and food, air is more needed to survive. The air quality that inhaled by living creatures influence the sustainability of life. The decrease of air quality is caused by air pollution as a result of the increased urban activities such as transportation, trades, energy generator, households, and industries.

The cement industry is one of the potential cause of air pollution as an effect of the cement processing that generate exhaust gas emission. Some potential gas that can be pollutants in environment are sulfur ( $\text{SO}_2$ ) and nitrogen ( $\text{NO}_2$ ). The generated sulfur dioxide ( $\text{SO}_2$ ) gas will reacted with water vapour and form sulfuric acid which fell with the rainwater, causing corrosive acid rain. Acid rain will increase acidity of the soil and superficial water which is harmful for fish and plants. In 2012, PT. Semen Indonesia (Persero) Tbk. produced cement as much as 9,279,800 tons with load of  $\text{SO}_2$  emissions generated in the amount of 287,823 kg (Anonymous, 2013).

Air pollution in Padang city caused by several industries. Based on the data from Regional Environmental Impact Management Department (BAPEDALDA) Padang, eleven big factories engaged in the processing of raw materials causing air pollution in Padang city. The two types of factory which have potential for causing pollution are rubber factory that emit odour and cement factory that have a major impact. Pollution caused by cement factory is not only bad smell but also dust, dirt, and gas emission such as carbon monoxide (CO), nitrogen dioxide ( $\text{NO}_2$ ), sulfur dioxide ( $\text{SO}_2$ ), lead (Pb) and ozone ( $\text{O}_3$ ) (Suryani & Upe, 2010).

PT. Semen Padang is a cement industry in Padang city that produces dust particulates and exhaust gas emissions from incineration in cement production. It uses dust vacuum machine such as electrostatic precipitator (ESP) to prevent dust waste and exhaust gas emission. However, this effort has not been able to optimize the prevention of dust waste and gas emission pollution yet. The Head of BAPEDALDA Padang City stated that the air monitoring equipment in PT. Semen Padang could not measure the quantity of air pollution accurately, while the filter device is still not qualified yet.

Based on the matters above, it is significant to study about countermeasure of  $\text{SO}_2$  gas emission in PT. Semen Padang through utilization of CaO nanoparticles as an effort to reduce gas emission which pollute air. The purpose of this research is to analyse the role of CaO nanoparticles in cement processing system to reduce  $\text{SO}_2$  gas emission in PT. Semen Padang.

## 2. Material and methods

### 2.1 Types of research

This research use descriptive qualitative and quantitative approaches based on the study of literature and research results. These approaches are expected to provide a thorough overview about the potential of the object study. In this case, the authors provide an alternative solution to overcome  $\text{SO}_2$  gas emission in PT. Semen Padang by conducting experiments in the laboratory.

### 2.2 Tools and material

The tools used in this research are glassware, mortar pestle, stirrer (Selecta Multimatic-5N), furnace (Neycraft), oven (France Etuves XU 225), analytical balance (KERN ABS), FTIR (Perkin Elmer), XRD (X 'Pert Pro), XRF (PANalytical), iron pipe, plastic glass, rubber bands and straps.

The material used in this study are limestone, 1 mL glacial acetic acid  $\text{CH}_3\text{COOH}$ , 0.15 M  $\text{H}_2\text{C}_2\text{O}_4$  oxalic acid, distilled water, acetone and ethanol  $\text{C}_2\text{H}_5\text{OH}$ .



## 2.3 Technic design

### 2.3.1 Synthesis of CaO nanoparticles

CaO nanoparticles are synthesized from limestone and then acetic acid is added to produce  $\text{Ca}(\text{CH}_3\text{COO})_2$ . Then, it is dissolved in distilled water to produce 100 mL of 0.1 M calcium acetate  $\text{Ca}(\text{CH}_3\text{COO})_2$ . The precipitate of  $\text{CaC}_2\text{O}_4$  calcium oxalate obtained by adding 50 mL of 0.15 M oxalic acid slowly while stirring it at 160 rpm for 12 hours at room temperature. The solid product is obtained with a centrifuge, followed by washing it consecutively with distilled water and acetone and dried it in an oven at 120°C for 12 hours. The dry solids are calcined in a furnace at 800°C temperature for 6 hours.

### 2.3.2 Characterization of CaO nanoparticles

- Analysis of functional cluster

Analysis of functional cluster uses a spectrophotometer Fourier Transform Infra-Red (FTIR), which is done by mixing the sample into KBr pellets with 1% sample composition of the total mixture. Then, it is characterized in wave numbers between 4000  $\text{cm}^{-1}$  to 400  $\text{cm}^{-1}$ .

- Analysis of crystallinity

Characterization using X-Ray diffraction (XRD) conducted to identify the crystalline phase and to analyze whether the samples that have been synthesized form CaO nanoscale materials or not. CaO samples are changed into powder for the purposes of XRD characterization. A total of  $\pm 0.2$  g sample is placed into a mould (sample holder) and then irradiated with Cu K $\alpha$  radiation source ( $\lambda = 1.54056$ ) with  $2\theta$  angle range at 5-90°, and scan speed 0.020°.

- The reaction of SO<sub>2</sub> and CaO nanoparticles

After CaO nanoparticles are synthesized, the particles are reacted with SO<sub>2</sub> gas emission from cement processing. Before the exhaust gas enters the chimney to be released into the air, it is reacted first by making some sort of reservoir space exhaust. The chamber is contained with CaO nanoparticles, so that when the SO<sub>2</sub> gas enter the space, it will react spontaneously and generate CaSO<sub>3</sub> salt. CaSO<sub>3</sub> is placed into the sample container.

### 2.1 Testing technic / data acquisition

After CaO nanoparticles are synthesized, the particles are reacted with SO<sub>2</sub> gas emission from cement processing with various SO<sub>2</sub> absorption time by CaO nanoparticles. Before the gas emission reach the air, they are flowed into a plastic glass through an iron pipe. The plastic glass contains CaO nanoparticles, so that when the SO<sub>2</sub> gas enter the chamber, the SO<sub>2</sub> gas emission react spontaneously with CaO nanoparticles to produce solid CaSO<sub>3</sub>. From these reactions, the level of sulfur (S) (%) to absorption time are determined by using X-Ray Fluorescence (XRF).

### 2.5 Data analysis techniques

Data analysis in the qualitative and quantitative writing based on the results of research and literature review. The data collected in a certain period of this research. There are two main models for data analysis in qualitative writing; flow model analysis

and interactive model analysis. In this study, the author use an interactive model that includes four components: data collection, data reduction, data presentation (display) and data verification / conclusion drawing. Data analysis and synthesis can be shown in this illustration below

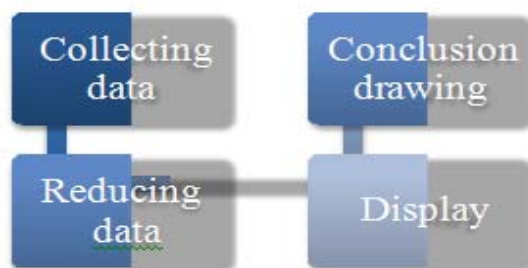

Figure 1. Flow Chart of interactive models of analysis

### 2.6 Flow stages research activities

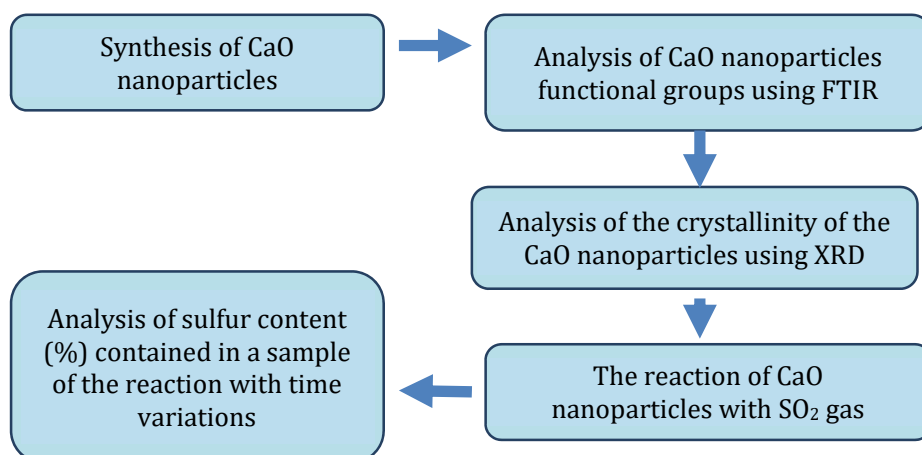

Figure 2. Flow stages research activities

## 3. Results and discussion

### 3.1 Synthesis of CaO nanoparticles

CaO nanoparticles that synthesized from limestone are aimed to be reacted with SO<sub>2</sub> gas emissions from the burning of coal at PT. Semen Padang, thereby reducing the levels and impact of SO<sub>2</sub> gas emissions in the air. The synthesis is done by a particular method named coprecipitation which is one method of synthesis for inorganic compounds based on the deposition of more than one substance together when passing through the point of saturation (Rosyidah, N., *et al*). The CaO nanoparticles are synthesized by adding glacial CH<sub>3</sub>COOH acetic acid into limestone that has been grinded to form a precursor, namely Ca(CH<sub>3</sub>COO)<sub>2</sub> and the similar settling agent that was used by Kanade, *et al* (2006). The settling agent is in form of a solution of oxalic acid H<sub>2</sub>C<sub>2</sub>O<sub>4</sub> with concentration of 0.15 M. This study uses distilled water as the solvent. Ca(CH<sub>3</sub>COO)<sub>2</sub> is dissolved in distilled water until the volume of solution become 100 mL and obtained solution becomes 0,1 M Ca(CH<sub>3</sub>COO)<sub>2</sub>. The turbid solution of 0,1 M Ca(CH<sub>3</sub>COO)<sub>2</sub> is formed as a result.

The next process is adding 0.15 M oxalic acid solution dropwise while stirring by using a magnetic stirrer at 160 rpm for 12 hours (Rahmawati, S., 2011). Then, it is covered

with aluminium foil to prevent evaporation in the solution. The result is the increased of turbid solution and white coloured which indicated that the solution has been saturated and it forms a solution of calcium oxalate,  $\text{CaC}_2\text{O}_4$ . The coprecipitation reaction is shown as follows, Kanade, *et al* (2006):

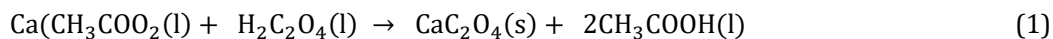

The obtained result then centrifuged to separate solid  $\text{CaC}_2\text{O}_4$  from solution. The precipitate obtained is washed using distilled water and followed by acetone to remove unreacted oxalic acid residual (Kanade, *et al.* 2006) and eliminate the organic compounds in  $\text{CaC}_2\text{O}_4$ . The obtained result is a white precipitate.

The white precipitate of  $\text{CaC}_2\text{O}_4$  is dried in an oven at  $120^\circ\text{C}$  for 12 hours (Rahmawati, S., 2011). Once dried, it is calcined at  $800^\circ\text{C}$  for 6 hours to remove oxalate ions and remaining organic compounds and to obtain smaller particle size (Rahmawati, S., 2011). The CaO nanoparticles that are formed can be seen in Fig. 3.



Figure 3. The solid white of CaO nanoparticles

During calcinations process, the limestone  $(\text{CaCO}_3)_03$  decomposes into CaO and carbon dioxide gas  $\text{CO}_2$  by  $\Delta H_{298} = 177,8$  kJ. Calcination process produce the white coloured CaO nanoparticles. The decomposition reaction of solid calcium oxalate into calcium oxide solids are written in the following equation:



### 3.2 Characterization of CaO nanoparticles

#### 3.2.1 Analysis of functional cluster

The Analysis of the functional cluster is performed using FTIR spectrophotometer at a wavelength of  $4000\text{-}400\text{ cm}^{-1}$ . The result of FTIR spectra then analyzed qualitatively to determine the functional cluster. The analyzed samples are synthesized CaO nanoparticles of the limestone. The FTIR spectrum of CaO nanoparticles can be seen in Fig. 4.

In Figure 4, it can be seen that a sharp peak at wave number  $3639.71$  show stretching vibration of the OH group  $\text{Ca}(\text{OH})_2$ . Broad peak centered at  $2992.12\text{ cm}^{-1}$  related to the -OH stretching vibration of  $\text{H}_2\text{O}$ , showed the presence of water absorbed on the surface of CaO. Peak at wavenumber  $1786.79\text{ cm}^{-1}$  can be interpreted as carbonyl (C = O) caused by the carbonyl stretching mode.

<sup>1</sup> The coprecipitation reaction

<sup>2</sup> The decomposition reaction of solid calcium oxalate into calcium oxide solids

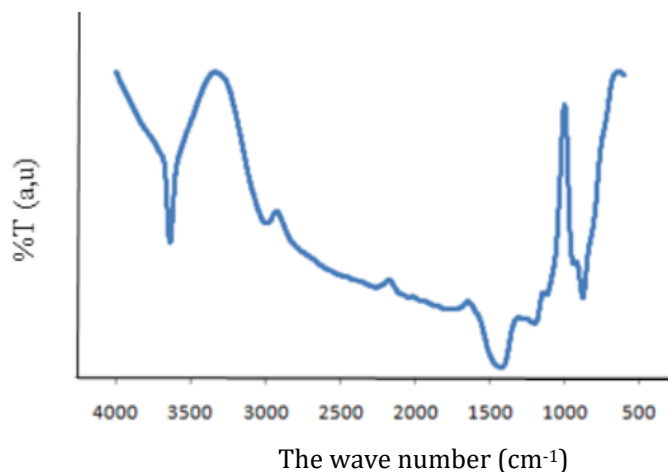

Figure 4. FTIR spectrum of the CaO nanoparticles

Peak at wave number  $1424.68\text{ cm}^{-1}$ – $1199.18\text{ cm}^{-1}$  can be interpreted as the stretching vibration of symmetry and asymmetry from O-C-O bonding of monodentate carbonate on the surface of CaO. Band at wave number  $877.01\text{ cm}^{-1}$  is the buckling carbonate cluster vibration. This is consistent with the explanation of Yulianti, CH (2011).

### 3.2.2 Analysis of crystallinity

The analysis of crystallinity aims to determine the degree of crystallinity of the CaO nanoparticles. The analysis is performed using an instrument *X-Ray Diffraction* (XRD). According to Albuquerque *et al.* (2009), in the CaO nanoparticles, the synthesis result is still having a diffraction pattern associated with the phase of  $\text{CaCO}_3$ . Diffractogram of the CaO nanoparticles test results can be seen in Fig. 5.

In Fig. 5, the peak at  $2\theta$  area which is  $18.05^\circ$  is the culmination of  $\text{Ca}(\text{OH})_2$ . The peak of CaO appears in the region  $2\theta$  is  $54.30^\circ$  with the intensity of 9.88%. But in diffractogram, the analysis results using XRD shown a sharp peak in  $2\theta$  at  $29.36^\circ$ , it indicates that  $\text{CaCO}_3$  peak with a higher intensity. A sharp peak indicates that the analyzed samples are crystalline compounds, because the crystalline compounds characterized by sharp peaks in the FTIR spectrum.

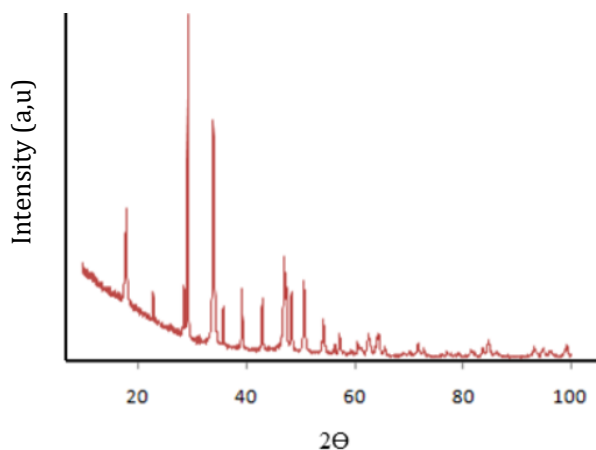

Figure 5. The diffractograms of CaO nanoparticles

The magnitude of the intensity of  $\text{CaCO}_3$  in XRD analysis diffractogram caused by  $\text{CO}_2$  impurity compounds that reacted with CaO when the samples are characterized using

XRD. This allows the formation of  $\text{CaCO}_3$  through the absorption of  $\text{CO}_2$  from the atmosphere that react slowly with  $\text{CaO}$ . The chemical reaction that occurs is as follows:



### 3.3 The reaction of CaO nanoparticles with $\text{SO}_2$ gas emission

The sample that used is the  $\text{SO}_2$  gas emission which derived from PT. Semen Padang where is located in Indarung IVC. The analysis is done by varying the time, such as 15 minutes, 30 minutes, 60 minutes and 120 minutes. The reaction of CaO nanoparticles with  $\text{SO}_2$  gas emission is done spontaneously. Through iron pipe, the gas emission is accommodated in a plastic glass which contained CaO nanoparticles. With the existence of gas emissions in these reservoir, CaO nanoparticles reacted immediately by absorbing and reacting with the gas emissions (absorbent). The reaction is as follows:



The results of CaO nanoparticles reaction toward the gas emission in the PT. Semen Padang can be seen in Fig. 6.



Figure 6. The results of CaO nanoparticles reaction against the gas emissions in PT. Semen Padang

In Fig. 6 can be seen the difference of the color from the white solid CaO becomes bluish by the variation of time. It is because there is a reaction with chimney gas emissions Indarung IV C in PT. Semen Padang.

The gas emission get into the reservoir consist of  $\text{SO}_2$ , NO, CO and dust particulate. In this sampling, the levels of compounds in gas emission from incineration was analyzed. Analysis is done by direct reading methods (*insitu*) using a gas analyzer.

The tool can be directly used to determine the concentration of air contaminants. It uses a sensor system based on the chemical and physical properties of contaminants (Arief, M). The result of the measurement can be known directly from its print-out. Gas analyzer is connected to the chimney and set to zero, then the sensor is inserted into a hole in the chimney where sample is analyzed. Automatically, the tool works and the results are shown on the monitor.

The results of gas emission analysis from the chimney of Indarung IV C PT. Semen Padang showed that the levels of  $\text{SO}_2$ , NO, and CO are respectively  $9 \text{ mg/m}^3$ ,  $48 \text{ mg/m}^3$  and  $171 \text{ mg/m}^3$ . Furthermore, the gas emission reacts with CaO nanoparticles and form a solid  $\text{CaSO}_3$ . The relation of absorption time to the level of sulfur ( $\text{SO}_2$  gas emission) in absorption by CaO can be seen in Fig. 7.

<sup>3</sup> The Chemical Reaction of  $\text{CaCO}_3$

<sup>4</sup> The Reaction of  $\text{CaSO}_3$

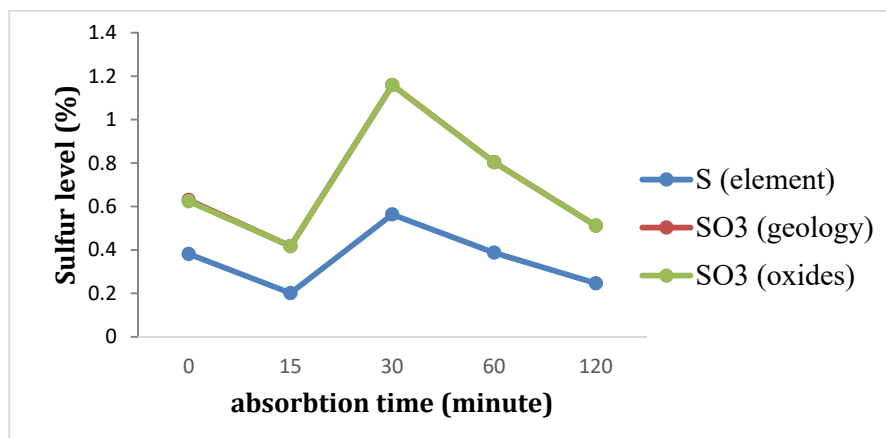

Figure 7. The relation of absorption time to the level of sulfur (S) in absorption by CaO

In Fig. 7 shows that the sulfur level, S (%), at the 30<sup>th</sup> minutes in the elemental form (0.563%), the geology (1.159%) and as an oxide (1.159%) are higher than the level of sulfur in the 15<sup>th</sup>, 60<sup>th</sup>, and 120<sup>th</sup> minutes. At the 30<sup>th</sup> minutes, it shows that the SO<sub>2</sub> gas emission reacts to CaO more than in the 15<sup>th</sup>, 60<sup>th</sup>, and 120<sup>th</sup> minutes. This is evidenced by the reduced level of calcium in the absorption by CaO, can be seen in Fig. 8.

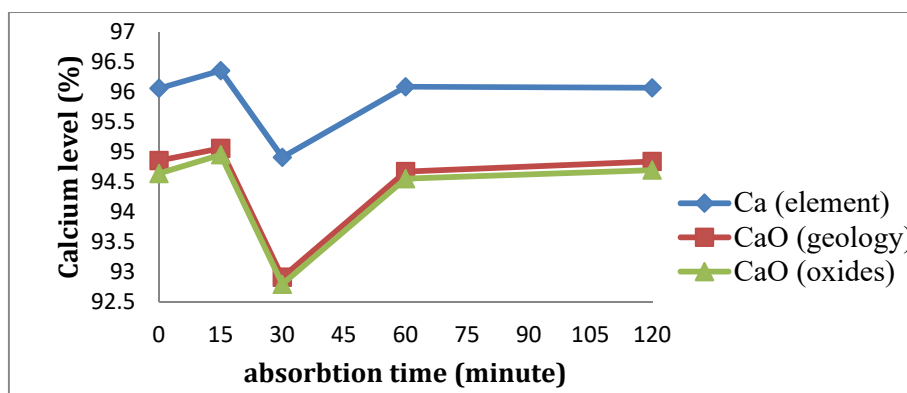

Figure 8. The relation of absorption time toward the levels of calcium (Ca) in absorption by CaO

Fig. 8 shows that the levels of calcium (Ca) lower at the 30<sup>th</sup> minutes. This is because at the 30<sup>th</sup> minutes the absorption of CaO to SO<sub>2</sub> gas emission is higher than at the 15<sup>th</sup>, 60<sup>th</sup>, and 120<sup>th</sup> minutes. Thus, from the results of research, the optimum absorption of CaO nanoparticles to the emission of SO<sub>2</sub> gas is for 30 minutes.

#### 4. Conclusion

The result of CaO nanoparticles synthesis from limestone by coprecipitation method obtained in the white solid. The characterization of CaO nanoparticles produced include the analysis of functional cluster and crystallinity showed that the analysis of functional cluster are the peaks of the OH cluster of Ca(OH)<sub>2</sub>, -OH cluster of H<sub>2</sub>O, carbonyl (C = O) and OCO cluster, and the crystallinity are Ca(OH)<sub>2</sub> peak in the region of 2θ angle is 18.05°, CaO peak at 2θ is 54.30°, CaCO<sub>3</sub> sharp peaks at 2θ is 29.36°. The sharp peak indicates that the sample is a crystalline compound. The reaction of the CaO nanoparticles with SO<sub>2</sub> gas emission is the formation of solids CaSO<sub>3</sub>. The optimum absorption time in the SO<sub>2</sub> absorption process by CaO nanoparticles is 30 minutes where the sulfur S (%) level of the reaction results is 0.563% in elemental form, 1.159% in geology and 1.159% in oxides.

## Acknowledgement

The researchers would like to address our first gratitudes to Rector, Vice Rector III and Lecturer of State University of Padang for the chances to strengthen our academic intellectuals, big thanks to Mr. Amrullah Rangkuti, Mr. Musytaqim Nasra and employees in Safety, Health and Environment Department of PT. Semen Padang for their beneficial thoughts and conveniences to allow us doing the research. We also thank you very much for drg. Rifani, Jeki Aridianto, S.Pd and Monica for always showed his open mind to give evaluative suggestions for this research.

## References

- Allen, D., & Hayhurst, A. N. (1996). Reaction between Gaseous Sulfur Dioxide and Solid Calcium Oxide Mechanism and Kinetics. *Journal of the Chemical Society, Faraday Transactions*, 92 (7), 1227–1238. doi: 10.1039 / FT 9969201227.
- Anonim. (2013). Ringkasan Kinerja Pengelolaan Lingkungan PT. Semen Indonesia (PERSERO) Tbk. (pp. 1–20).
- Anonim. (2014). Penurunan Emisi. <http://www.csr-semenindonesia.com/penurunan-emisi/#.VDwq8RCSzq> Last Accessed 10 October 2016
- Arief, M. (2015). *Metode Sampling*. Jakarta: Universitas Esa Unggul.
- Canham, G.-R., & Overton, T. (2010). *Descriptive Inorganic Chemistry (Fifth., p. 153)*. New York: W. H. Freeman and Company.
- Kanade, K.G., et al. 2006. Effect of Solvents on the Synthesis of Nano-Size Zinc Oxide and Its Properties. *Journal of Elsevier*. Vol. 41: 590-600.
- Novyanti, Jasruddin, & Sujiono. (2015). Karakterisasi Kalsium Karbonat (Ca(CO<sub>3</sub>)) Dari Batu Kapur Kelurahan Tellu Limpoe Kecamatan Suppa. *Jurnal Sains dan Pendidikan Fisika*. Jilid 11, Nomor 2, Agustus 2015, page 169 – 172. Makassar: FMIPA Universitas Negeri Makassar.
- Rahmawati, S., Prasetyoko, D., & Ediati, R. (2012). *Sintesis Partikel Nano CaO Dengan Metode Kopresipitasi Dan Karakterisasinya*. Surabaya: Institut Teknologi Sepuluh Nopember.
- Rosyidah, N., et al. *Sintesis Nanopartikel ZnO dengan Metode Kopresipitasi*. *Jurnal Teknik Pomits*. p.1-7. Surabaya: Institut Teknologi Sepuluh Nopember.
- Sucipto, E. (2007). *Hubungan Pemaparan Partikel Debu pada Pengolahan Batu Kapur Terhadap Penurunan Kapasitas Fungsi Paru*. Semarang: Universitas Diponegoro.
- Sukarsono. (2010). *Kajian Pengurangan SO<sub>2</sub> dan NO<sub>x</sub> dari Gas Buang Hasil Pembakaran dengan Akselerator*. *GANENDRA*, III (1), 14–23.
- Suryani, S., & Upe, A. (2010). *Model Sebaran Polutan SO<sub>2</sub> Pada Cerobong Asap PT. Semen Tonasa*, 2, 14–16.
- Yulianti, CH. (2011) *Sintesis dan Karakterisasi Katalis Nanopartikel CaO*. *Jurnal Teknika*. Vol.3. No.2. Jawa Timur: Universitas Islam Lamongan.

---

**Young Teak Application for Making Products  
Case Study: Young Teak from the Teak Plantation in  
West Java Area, Indonesia**

Imam Damar Djati<sup>a</sup> and Mitsunori Kubo<sup>b\*</sup>

<sup>a</sup>*Program Studi Desain Produk, Fakultas Seni Rupa dan Desain, Institut Teknologi  
Bandung, Jl. Ganesha 10, Bandung 40132, Indonesia*

<sup>b</sup>*Department of Design Science, Graduate School of Engineering, Chiba University,  
1-33 Yayoi-cho, Inage-ku, Chiba-shi, Chiba, 263-8522 Japan.*

---

**Abstract**

The demand of wood is increasing, but the supply is limited, on the contrary, there are amount of potential young teaks (*Tectona grandis* L.f.) from the thinning of teak plantations that could contribute to meet this demand. This research intends to develop the suitable application of potential young teak from the thinning of the teak plantation in West Java area, Indonesia, for making products by taking the advantage of its prominent mechanical properties and characteristics. This research has assessed the mechanical properties, including bonding practice, and the characteristics of young teak from each of age classes in the rotation age of 40 years. Mechanical properties of young teak are the determination of its MOR and MOE, The result shows that there is no significant difference of strength between teak and young teak among the age classes, and young teak is having better bonding performance than mature teak. Characteristics of young teak vary in the grain of border and its color. Various contrast border-patterns between sapwood and its heartwood parts have been identified, and by using the certain configuration and joint systems create the unique appearances for application into various products. Approaches and methods in this research are also practicable to be applied for another wood species in which comprise sapwood and heartwood part in their wood trunk.

**Keywords**

Young teak; border-patterns; configuration; unique appearances; application

---

**1. Teak and Young Teak**

Teak (*Tectona grandis* L.f.) has been recognized as one of the famous and important species of tree from the tropical areas. Wood from teaks is well known for its pleasant color, fine grain, and durability. The heartwood of teak varies from yellow brown to rich brown and frequently shows streaks of dark color. The wood has coarse texture, straight-grained, distinct oily feel, and unpleasant odor of leather when freshly cut (Pandey, 2010). Teak can be seasoned well but it is rather slowly and therefore requires more than ordinary care in determining both the initial and final moisture contents (Glass, 2010). Teak can be finished and glued satisfactorily, although some pre-

---

\* Corresponding author. Tel.: +62 8122023903. E-mail address: imamdj@fsrd.itb.ac.id



finishing and special surface treatments may have to be considered to ensure good bonding of finishes and glues (Wiemann, 2010), and therefore teak is categorized as the wood with difficulty in bonding, as the effect of its high density, moisture, and extractive content inside the wood cells (Frihart, 2010).

Currently, teak is used in the construction of boats, furniture, decorative objects, veneer, and many other products. Teak has become the most tropical hardwood in demand for a specific market of special and luxury applications because of its *strength*, *durability*, and *distinctive aesthetic* qualities (Wiemann, 2010). Now in the market and production of wooden teak products, there are not only mature teaks that usually could be bought and to be used, but also available young teaks for this occasion, as an effect of wood increased in demand but on the other hand it become limited in supply.

Application of teak (mature teak) as one of the prominent material for making the special and luxury products are have been being used from hundreds years ago until now, but on the other hand, the use of young teak for making products is just to be considered about several years ago, due to the market demand of wood material is increasing, while the mature teak is becoming higher in market price and the supply of teak from the natural forest has decreased during the time. The other aspect also has occurred that the area of teak plantation is increased and therefore the supply of teak is dominated from the teak plantation in which the young teak is included due to the thinning process of its teak plantations (FAO-UN, 2012).

The period from planting until harvesting is called the *rotation age*. Teak plantations in Java Island, Indonesia, which is managed by Perum Perhutani, use the rotation age of 40 years and the rotation age of 80 years. During the rotation age, a number of young teak trees, which mostly comprise sapwoods, will be felled due to the *thinning* to stimulate the best growth of remaining teak trees in the teak plantations. As a particular case, in one of the teak plantations, for 1 hectare of teak plantation with the site quality index of *bonita III/IV* (average quality class) and rotation age of 40 years, from 1,769 5-year-old teak trees will be felled regularly during the rotation age until 277 39-year-old teak trees remain at harvesting. There are six site classes (*bonita I - bonita VI*) for recognizing areas of teak plantation in Java, and each site class has different thinning for felling a number of its teak trees (PT. Perhutani, 2001).

At the present, only in Java Island, there are at least 1.21 million hectares of teak plantations. This is the second largest area of teak plantation in a country in the world (Kollert, 2012). The average production of logs and timbers from these teak plantations area are 0.4 million m<sup>3</sup> annually (Perum Perhutani, 2014). Consider to the significant amount of young teaks from the thinning is available, it is necessary to utilize these potential material become suitable products by taking the advantage of its mechanical properties and prominent characteristics to enhance its utilization and value. This is important for Indonesia especially, who has the wide teak plantation area that is possible to be increased for getting the advantages from this potential material optimally, both at present and in the future.

Although the young teaks and teaks from the thinning are have been utilizing for making products, but the assessment to its mechanical properties and characteristics is relatively limited. The data and information about teak usually refers to its mature teak. Description about properties and its characteristic of teak especially refer to the heartwood part of the mature teak. It will be different to the young teak.

## 2. Material and Methods

Teak materials for making of specimens of tests in this research are obtained from the West Java area, Indonesia, which is categorized as:

- The young teak logs from the thinning of teak plantation, which is still comprise mostly sapwood part; and
- Small beams or planks of sawing and re-sawing of teak logs, timbers, or lumbers, which is still contain proportions of both sapwood and its heartwood part. These are recognized as removed waste material, not standard size and narrow relatively.

The mechanical properties of young teak from the thinning of West Java area's teak plantation has been recognized in the previous research that is determined uses *static bending test* (three points). In this research, another six additional tests have been conducted to complete the mechanical properties of young teak in particular, those are :

- Compression Strength Parallel to grain;
- Tension Strength Parallel to grain;
- Compression Strength Perpendicular to grain;
- Tension Strength Perpendicular to grain;
- Cleavage Strength Parallel to grain; and
- Shearing Strength Parallel to grain.

For the tests occasion, teak material has been categorized in range as Age Class I-II (10-20 year-old) and Age Class III-IV (30-40 year-old). Standard methods for testing are adapted and modified from the ASTM, Designation: D 143 (*Small Clear Specimens of Timber*) (ASTM, 2010), and then it is combined to SNI 03-3960-1995, *Test Method for Modulus of Bending Elasticity of Wood in Laboratory* (SNI, 2013). The laboratory for testing is conducted at Structure Engineering Laboratory - Bandung Institute of Technology, Indonesia. The device/machine for testing is Universal Testing Machine (UTM) Ibertest, series Eurotest - 200, Made in Spain; Year of production is 2012. The *speed of testing (displacement control)* of UTM is set to the type of control by position, and the speed is set according to the standard for each test categories respectively, but the *load control* for all of the test are set at 98.0665 N/s (*load increasing*). Time of tests has been arranged in March and September 2013.

For getting the appropriate result, before the test is started, all of the specimens must be confirmed of its moisture, it is not exceed more than 20% (standard of maximum), and also the humidity and temperature of the place where the test is conducted. The tests have been conducted in relative humidity 60% ( $\pm 5\%$ ) and temperature 25°C-27°C, and the moisture content of the specimen is 15%-19% at radial and 16%-19% at tangential. Number of specimen is 2-3 pieces for each age classes and each type of specimen respectively that is conducted for six additional various tests.

The basic data has been added also by the *Measuring of Weight Density*, as one of determination factor for confirmation of strength class, and in this case, the weight density as a sample to compare among the specimen from the various age class and wood species. This research also has been conducted of tests for getting the bonding properties of young teak in particular. Falcata (*Paraserianthes falcataria*) and Kapur (*Dryobalanops beccari*), are used for comparison in bonding test. These wood are represented as bond easily and bond with difficulty, according to ease of bonding categories (Frihart, 2010). Type of adhesive that is used in these tests is *poly vinyl acetate* (PVAc), as an ordinary glue for bonding of wood in general occasion.

This research also has conducted to determine the characteristic of color lightness of teak surface from the previous research. The data is determined uses lux meter at daylight shade in the midday condition ( $\pm 20,000$  lux), and the distance between lux-meter to the specimens is 100 cm. The main purpose of this determination is conducted for getting the ratio comparison among various teak surfaces after coloring by colorant (*food grade type*) and water based polishing respectively.

### 3. Research Finding

#### 3.1 Strength Class of Young Teak

According to the *strength classification of the wood* in Indonesia, as it is described in Table 1, the *strength class* of wood is divided into five classes and refers according to the weight density and MOR of its wood, and teak from Java Island has been recognized as the wood with the standard *strength class II* (Martawijaya, 1981). Based on the previous research that is compared to the *standard strength class of wood*, and therefore the young teaks from various age classes can be classified for having the strength in the same range with mature teak, according to its density and the result of Modulus of Rupture (MOR), as it is described in Table 2. The exception is just for sapwood of *age class I*, which the MOR is lower than the minimum of standard (Djati, 2015).

Table 1. The standard of strength class of wood in Indonesia (Martawijaya, 1981)

Strength Class	Weight Density	MOR (MPa)
I	> 0.90	> 107.87
II	0.60 - 0.90	71.098 - 107.87
III	0.40 - 0.60	49.03 - 71.098
IV	0.30 - 0.40	35.30 - 49.03
V	< 0.30	< 35.30

Table 2. Test data sheet of static bending (Djati, 2015)

Speed of Testing		0.1 inch/min (2.54 mm/min)			
Size of Specimen		20 x 20 x 300 mm <sup>3</sup> ( <i>width x depth x length</i> )			
Age Class (year-old)	Part in Trunk	Weight Density (gr/cm <sup>3</sup> )	Max. Load (kN)	MOR (MPa)	MOE (GPa)
I (1-10)	SW	0.613	1.004	52.709	6.989
	HW	0.635	1.529	80.263	7.051
II (11-20)	SW	0.652	1.741	91.413	10.029
	HW	0.617	1.650	86.657	8.893
III (21-30)	SW	0.622	1.744	91.570	9.332
	HW	0.720	1.745	91.615	9.438
IV (31-40)	SW	<i>Size of sapwood part is smaller than the minimum standard size of specimen for testing</i>			
	HW	0.781	1.555	81.623	8.840
Teak ( <i>standard</i> )		0.67-0.75	-	101.106	12.523

#### 3.2 Mechanical and Bonding Properties

The assessment also has been conducted to the number of tests for getting the mechanical and bonding properties of young teak. Bonding practice has been conducted and it has been compared the strength of bonding among teak, young teak and another wood material for comparison occasion. According to some research, teak has been recognized as the wood with *bonding difficulty* (Frihart, 2010). This recognition may refer to the bonding property for mature teak, and therefore it is possible that the young teak is having the different property. The determination to examine of bonding

characteristic is necessary to be conducted for comparing the ease bonding categories, and therefore the tests are conducted for each type of specimen, with and without adhesive applying. The test results for each type of testing that is especially applied to the young teak specimens and another wood material are described in several *Test Data Sheets* respectively. The tests results as are described in Table 3 - Table 8, whereas bonding tests are adapted to the four basic tests as are described in Table 4, 6, 7, and 8.

Table 3. Test data sheet of compression strength parallel to grain

Speed of Testing		0.024 inch/min (0.6 mm/min)		
Size of Specimen		20 x 20 x 80 mm <sup>3</sup> ( <i>width x depth x length</i> )		
Age Class (year-old)	Part in Trunk	Weight Density (gr/cm <sup>3</sup> )	Max. Load (kN)	Max. Load to Area (MPa)
I-II (10-20)	SW	0.63	33.539	33.539
	HW	0.63	17.726	17.726
III-IV (30-40)	SW	-	-	-
	HW	0.69	45.284	45.284
Teak ( <i>standard</i> )		0.67	-	53.937

Table 4. Test data sheet of tension strength parallel to grain

Speed of Testing		0.05 inch/min (1 mm/min)		
Size of Specimen		20 x 20 x 300 mm <sup>3</sup> ( <i>width x depth x length</i> )		
Age Class (year-old)	Part in Trunk	Weight Density (gr/cm <sup>3</sup> )	Max. Load (kN)	Max. Load to Area (MPa)
I-II (10-20)	SW	0.63	9.696	96.963
	HW	0.64	8.213	82.135
III-IV (30-40)	SW	-	-	-
	HW	0.69	9.631	96.311
<i>Adhesive applied</i>				
I-II (10-20)	SW	0.62	1.583	3.957
	HW	0.69	1.654	4.135
III-IV (30-40)	SW	-	-	-
	HW	0.69	0.966	2.390
Falcata		0.33	1.268	3.173

Table 5. Test data sheet of compression strength perpendicular to grain

Speed of Testing		0.012 inch/min (0.305 mm/min)		
Size of Specimen		20 x 20 x 60 mm <sup>3</sup> ( <i>width x depth x length</i> )		
Age Class (year-old)	Part in Trunk	Weight Density (gr/cm <sup>3</sup> )	Max. Load (kN)	Max. Load to Area (MPa)
I-II (10-20)	SW	0.63	5.516	13.788
	HW	0.64	7.9525	19.878
III-IV (30-40)	SW	-	-	-
	HW	0.69	9.668	24.173

Table 6. Test data sheet of tension strength perpendicular to grain

Speed of Testing		0.10 inch/min (2.5 mm/min)		
Size of Specimen		35 x 20 x 40 mm <sup>3</sup> ( <i>width x depth x length</i> )		
Age Class (year-old)	Part in Trunk	Weight Density (gr/cm <sup>3</sup> )	Max. Load (kN)	Max. Load to Area (MPa)
I-II (10-20)	SW	0.63	2.328	5.820
	HW	0.63	2.812	7.031
III-IV (30-40)	SW	-	-	-
	HW	0.69	1.872	4.680
Falcata		0.33	0.901	2.254
Kapur		0.59	2.297	5.744
<i>Adhesive applied</i>				
I-II (10-20)	SW	0.63	1.732	4.331
	HW	0.64	1.773	4.433
III-IV (30-40)	SW	-	-	-
	HW	0.69	1.781	4.453
Falcata		0.33	0.640	1.601
Kapur		0.59	0.994	2.486

Table 7. Test data sheet of cleavage strength parallel to grain

Speed of Testing		0.10 inch/min (2.5 mm/min)		
Size of Specimen		35 x 20 x 30 mm <sup>3</sup> ( <i>width x depth x length</i> )		
Age Class (year-old)	Part in Trunk	Weight Density (gr/cm <sup>3</sup> )	Max. Load (kN)	Max. Load to Area (MPa)
I-II (10-20)	SW	0.62	0.730	1.824
	HW	0.69	0.874	2.184
III-IV (30-40)	SW	-	-	-
	HW	0.69	0.902	2.256
<i>Adhesive applied</i>				
I-II (10-20)	SW	0.62	0.600	1.500
	HW	0.69	0.400	1.000
III-IV (30-40)	SW	-	-	-
	HW	0.69	0.354	0.885

Table 8. Test data sheet of shearing strength parallel to grain

Speed of Testing		0.24 inch/min (0.6 mm/min)		
Size of Specimen		20 x 20 x 30 mm <sup>3</sup> ( <i>width x depth x length</i> )		
Age Class (year-old)	Part in Trunk	Weight Density (gr/cm <sup>3</sup> )	Max. Load (kN)	Max. Load to Area (MPa)
I-II (10-20)	SW	0.62	5.611	14.028
	HW	0.69	6.820	17.049
III-IV (30-40)	SW	-	-	-
	HW	0.69	5.418	13.545
<i>Adhesive applied</i>				
I-II (10-20)	SW	0.62	3.828	9.568
	HW	0.69	5.265	13.162
III-IV (30-40)	SW	-	-	-
	HW	0.69	1.319	3.297

### 3.3 Border Patterns and Color Characteristic

Based on the previous research, the *border patterns* and the contrast of color between sapwood and its heartwood parts in mature teaks are usually obvious, and this is contrary to the young teaks in which the borders vary due to the incomplete process from sapwoods become heartwood parts. The young teaks have been recognized for having various *border patterns* on its transverse, tangential, and radial surfaces. Various types of border patterns, as shown in Fig. 1, are categorized in the *transverse surface* as (a) *serrated edge*, in contrast to the (b) *curved edge*; and (c) *obvious edge*, in contrast to the (d) *obscure edge*. At both the *radial surface* and the *tangential surface*, the various borders are categorized as (e) *linear edge*, in contrast to the (f) *meandering edge*; and (g) *obvious edge*, in contrast to the (h) *obscure edge* (Djati, 2015).

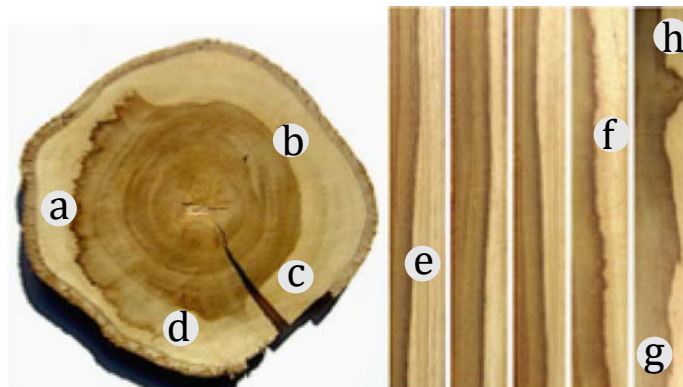

Figure 1. Various types of border patterns on transverse, tangential, and radial surfaces of young teak.

The difference of color intensity near to the borders edges on the heartwood parts also vary; darker and brighter color alternate between *early-woods* and *late-woods* at the growth rings, as an uneven process of formation and conversion of sapwood becomes heartwood. The chemical and extractive content in the borders of teak are also having the different content (Lukmandaru, 2009).

Color and lightness characteristic of young teaks those are compared to sapwood and its heartwood parts that the lighter color of sapwood surfaces have specific effect, i.e. to the finishing system as a consequence of the difference in color intensity of sapwood and its heartwood parts. Difference intensity of basic color has shown from the various part of teak after polishing that use colorant and water base polish. In the same color using, the result has shown that the darker color surface appears from the pieces of heartwood parts and the lighter color surface appears from the pieces of sapwood parts. Caused by the lighter color of sapwood surface, the coloring on sapwood surface will appear more *attractive* and *vivid* than on its heartwood as shown in Fig. 2. The sapwood surfaces are having higher lightness than its heartwood surfaces. This can be determined that after the use of colorant, the sapwood part surfaces indicate the higher ratio in which is compared to the mature teak in the same each color of colorant respectively as is described in Table 9 and Table 10.

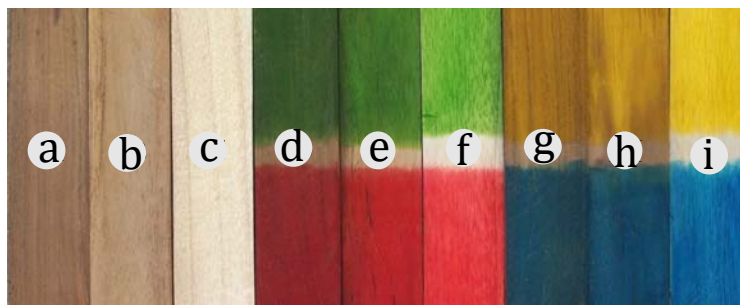

Figure 2. Difference color intensity on the surface of mature heartwood (a, d, and g), young heartwood (b, e, and h), and young softwood (c, f, and i) of teak after coloring.

Table 9. Lightness of Teak Surfaces

Teak Surface	without colorant (klx)	use colorant			
		Red (klx)	Green (klx)	Blue (klx)	Yellow (klx)
HW (mature)	5.7	4.1	4.2	5.4	5.3
HW (young)	8.1	4.6	5.4	6.2	6.4
SW (young)	10.4	5.3	7.2	7.0	8.9

Table 10. Ratio of lightness of young teak surfaces to mature teak surface

Teak Surface	without colorant (klx)	use colorant			
		Red (klx)	Green (klx)	Blue (klx)	Yellow (klx)
HW (mature)	1	1	1	1	1
HW (young)	1.42	1.12	1.28	1.14	1.20
SW (young)	1.82	1.29	1.71	1.29	1.67

#### 4. Conclusion

The result of determination has shown that there is no significant difference in the *strength* between heartwood and its sapwood of young teak, and the young teak has the same strength class with the mature teak and therefore basically it is possible to utilize this young teak for the ordinary application as well as the mature teak. Nevertheless, due to the trunk size of young teak that is narrower than the mature teak, therefore the application of young teak should consider the suitable products according to its limited

size. In addition, it is possible to enlarge the size of young teak, i.e. its thickness or its width, by using of certain wood joint system. The result has shown also that bonding is possible relatively to be applied for young teak especially, and this bonding characteristic is usable for wood jointing in particular for making products in which bonding is applied.

Mechanical properties and characteristics of young teaks and its various border patterns of sapwood and its heartwood part are prominent aspects that can be useful in practical application for making various products. Data about the strength and durability of young teak must be recognized for its application. Although young teak, which comprised mostly sapwood is considered to have the low durability, but some extra treatments are possible to be applied to enhance this low durability.

The attractive color of sapwood parts that usually recognized as a weakness is possible to be the advantage, i.e. if these parts will be use for making suitable product, e.g. products for kids, such as toys, educational equipment, et cetera. The utilization of young teak without any necessary modifications to its characteristics and properties is also possible as long as the utilization take into consideration to the suitability of young teak for the particular products.

Utilization of young teak for substitution material and for fulfil the demand of wood in wooden products industry is possible to enhance the value of this young teak and also for getting the advantage for social empowerment and economical point of view. This research approach and methods which has been applied to the young teak is possible practicable also to apply for another wood species in which comprise sapwood and heartwood part in their wood trunk.

## References

- ASTM (American Society for Testing and Materials). (2010). Designation: D143-09 (2010), Standard Test Methods for Small Clear Specimens of Timber. ASTM International, Pennsylvania. United States. Approved Edition.
- Djati, I.D., Tauchi, T., Kubo, M., Terauchi, F. (2015). Mechanical Properties and Characteristics of Young Teak for Making Products. *Bulletin of Japanese Society for the Science of Design*, Vol. 61 No. 5, pp. 77-86.
- FAO-UN (Food and Agriculture Organization of the United Nations). (2013). *State of the World's Forest 2012*. Rome. 2012. <http://www.fao.org/docrep/016/i3010e/i3010e.pdf>. Accessed 20th October 2013.
- Frihart, Charles R. and Hunt, Christopher H. (2010) Adhesives with Wood Materials Bond Formation and Performance. in: *Wood Handbook - Wood as an Engineering Material*. United States Department of Agriculture, Forest Service, Forest Products Laboratory.
- Glass, Samuel V. and Zelinka, Samuel L. (2010). Moisture Relations and Physical Properties of Wood. in: *Wood Handbook - Wood as an Engineering Material*. United States Department of Agriculture, Forest Service, Forest Products Laboratory.
- Kollert, Walter and Cherubini, L. *Teak Resources and Market Assessment 2010*. FAO Planted Forest and Trees Working Paper FP/47/E. Rome. 2012. <http://www.fao.org/docrep/015/an537e/an537e00.pdf>. [Accessed 20th October 2012]
- Lukmandaru, G., Ashitani, T., Takahashi, K. (2009). Color and Chemical Characterization of Partially Black-Streaked Heart-Wood in Teak (*Tectona grandis*). *Journal of Forestry Research*, 20(4): pp 377-380.
- Martawijaya, A. et al. (1981). *Atlas Kayu Indonesia*. Edisi I dan II (*translated: Indonesian Wood Atlas. Edition I and II*). Forestry Research and Development Center. Bogor-Indonesia.

- Pandey, D and Brown, C. (2000). Teak: a global overview. An overview of global teak resources and issues affecting their future outlook. *Unasylva* 201, Vol. 51.
- Perum Perhutani. (2014). Company History. <http://perumperhutani.com//profil/sejarah/>. Accessed 5th January 2014.
- PT. Perhutani (Persero) Unit III Jawa Barat (2001). *Petunjuk Teknis Pelaksanaan Penjarangan Hutan Tanaman*. Bandung. Translated: *Guidance of Thinning for Planted Forests*. [Note: PT. Perhutani (Persero) is one of unit companies in Perum Perhutani].
- SNI (Standar Nasional Indonesia). (2013). SNI 03-3960-1995, *Test Method for Modulus of Bending Elasticity of Wood in Laboratory*. <http://www.pu.go.id/satminkal/itjen/peraturan/sni/SNI%2003-3959-1995.pdf>. Accessed 13th February 2013.
- Wiemann, Michael C. (2010). Characteristics and Availability of Commercially Important Woods. in: *Wood Handbook - Wood as an Engineering Material*. United States Department of Agriculture, Forest Service, Forest Products Laboratory.



## **Hybrid Bamboo – Ceramic Process for Tableware design**

Hari Nugraha, Taufiq Panji Wisesa, Ismail Alif Siregar, E-mail:  
hari.nugraha@upj.ac.id

*Universitas Pembangunan Jaya, Jl Cendrawasih Sawah Baru, Ciputat Tangerang Selatan  
Banten 15413, Indonesia*

---

### **Abstract**

The use of materials that comes from nature such as bamboo and ceramics has been processed into fungsional products from centuries ago into its current form has been used by man kind to fulfill our needs. The combining of bamboo and clay has also been done generally. Usually the use of bamboo on ceramics products is for extra parts. For example, ceramics container, the bamboo is used as the handle of the container. Usually the process for both materials are separate and is joined at the final stage of the manufacturing or assembly.

From the research that has been done, the process of mixing of both material can be achieved by using a mixed hybrid material process, where the combination of bamboo and clay that is integrated into one product can be achieved by applying heat resistant chemical materials to the bamboo and baking it with the clay in the oven. The temperature of the oven would be set at a low setting (600°C-700°C). The use of this Mixed Hybrid Process in baking the ceramics and bamboo at the same time is hoped to achieve a functional product with inovative and aesthetic appeal, and can open the way to new ways of mixing bamboo and clay ceramics.

### **Keywords**

Bamboo; Ceramic; Hybrid; Mix material; Product Design

---

## **1. Introduction**

Materials that comes from nature are used by people, one of them is the bamboo plant. It is abundantly found in Indonesia from the Sumatra islands up to the east in area of Papua. Traditionally bamboo is used for basic materials for various uses. Besides its relatively cheap price, bamboo also has a high economic value. It is a sustainable material because it grows and can be harvested in a relatively short time compared to other wooden materials. Bamboo characteristically has a high tensile strength to support weight and a high elasticity (Widaja 2001). In its use, bamboo is easy to be cut and split. One of the advanced use of bamboo is to make a bio-composite material which can be used as a building material (Suhaily 2013).

In other Asian countries, bamboo has been processed into panel boards and particle boards (Nikogomo 2017), meanwhile in Indonesia bamboo is still processed in a

traditional manner by the artisans in Tangerang Selatan, an area in the province of Banten. 80% of the use of bamboo in Indonesia is used for building construction material (Warta Ekspor, December 2011 edition), beside that, bamboo is also used to make homeware and tableware products. The bamboo used for this is the locally known Apus Bamboo variety/ *Gigantochloa Apus* (Mayasari 2012). The tableware made from bamboo is commonly combined with other materials. The combination of these materials is to achieve an aesthetic look, or as a main component or support component from a fungsional product. The commonly used materials for these combination is wood and rattan. Rattans are mainly turned into a weave and binding component to join the bamboo components.

Other development in the processing of bamboo materials in the traditional or modern way is to make tableware product. The joining of this process results in a joined clay-bamboo (hybrid material processing) The clay that is used for this process is from the earthenware type. This type of clay is abundantly available in Indonesia and is easy and cheap to procure (Jone 2015). This type of processing technic is used during making, assembly or final finishing of the product.

Another technic from the research and experiments of the development of hybrid material processing for tableware products made from bamboo and clay is in the beginning stage of assembly where the bamboo and clay is joined together to form the product before it is put into the kiln. The bamboo material will need to be heat treated before it is joined with the clay so that it is not charred and burned when it is being fired in the kiln. Because of the limitation of the heat resistant material, the process of firing the clay and and bamboo will be limited to a low temperature of 600°C-700°C.

With the application of this technic bamboo clay hybrid process, it is hoped that a new inovation and more diversified function of joining system of different components of a earthenware product. Besides that with this technic new designs can be achieved, where the different material can be combined into a more aesthetically pleasing product. With this simple hybrid process, it is hoped that it can be used by small home industries in Indonesia, especially in the South Tangerang region of Banten province. For the future, this hybrid process can be used to develop other products with different uses and functions.

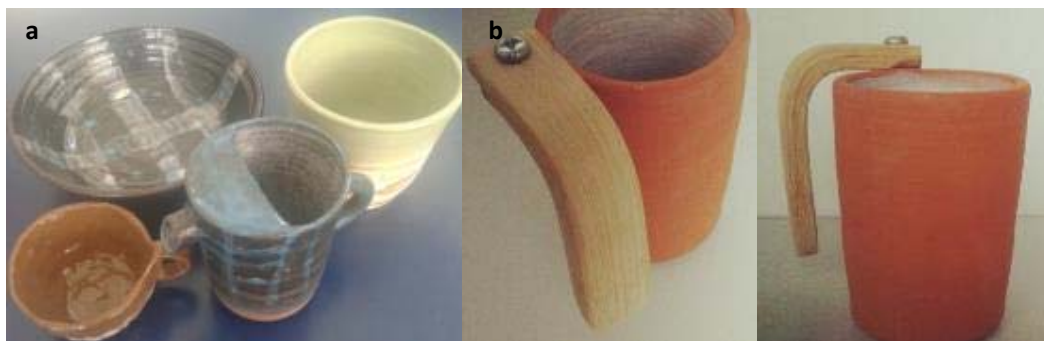

Figure 1(a) Ceramic tableware product; (b) Ceramic and bamboo for tableware product.

## 2. Material and Methods

### 2.1. Research Object

The hybrid process that will be applied to the tableware product will use bamboo and clay. The variety of bamboo used will be *Dendrocalamus Asper*, locally known as Betung bamboo. This type of bamboo grows in humid areas and can reach a height of 20 meters. This type of bamboo is widely available in all of Indonesia. This bamboo is chosen because it has a thick body with a minimum thickness of +/- 0.5 mm and the diameter can reach up to +/- 25 cm, with a bending property of  $161 \pm 11$  MPa (Ardhyanta 2012). With this thickness, the bamboo can be processed into strips that can be turned into laminated bamboo strips. The thickness of the laminated bamboo that will be used for the supporting component is +/- 0.5 cm up to +/- 1 cm. The type of clay used will be secondary clay (*Earthenware*) which could be fired in the kiln with a low temperature.

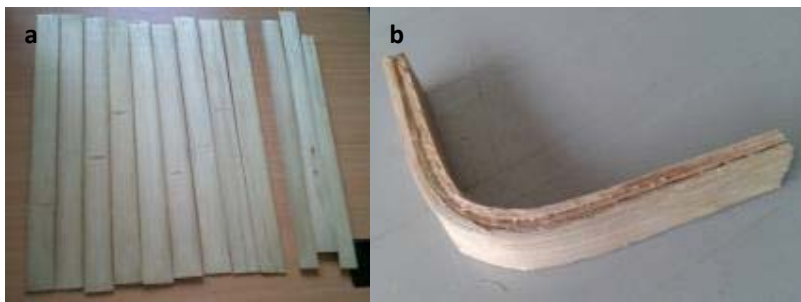

Figure 2 (a) Bamboo strip material; (b) Bamboo laminated material.

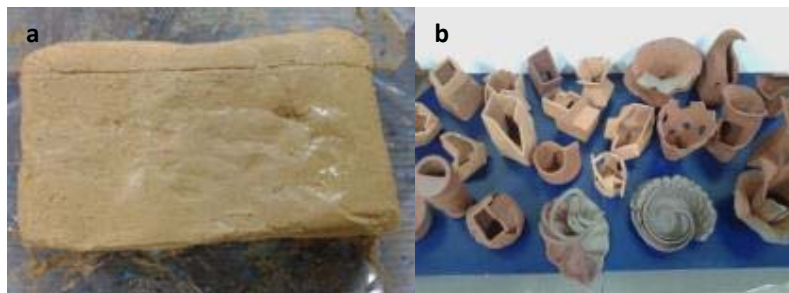

Figure 3. (a) Clay material (Earthenware); (b) Ceramic product.

The process of joining the bamboo and clay will need a heat resistant coating to help keep the bamboo from getting burned while the product is fired in the kiln. The type of coating used will be ones that are commercially available, which is sodium polyacrylate and ceramic fibre blanket uses for fire retardant (Raghuram 2016).



Figure 4(a)Ceramic fibre blanket material; (b) Sodium polyacrylate.

## 2.1 Methods

The process of making the hybrid process is started with determining the type of heat resistant coating that will be applied to the bamboo and how many layers of application will be needed so that it is heat proof so that the bamboo can survive during the firing process inside the kiln. The heat resistant material must be able to protect the bamboo up to 700°C and it has to be able to keep its heat resistant property up to 3-4 hours. (the length of time needed for the clay to be fired inside the kiln for low temperature firing). The kiln used will be using fire from a LPG (Liquefied Petroleum Gas) source. The heat coating that will be used in the experiment is by coating and covering the whole bamboo part thoroughly so that it would prevent any physical changes during the firing of the combined bamboo and clay in the kiln.

The next phase of the experiment will be to make alternative models of the product. This phase is to examine the effectiveness of the hybrid combination process. It is also used to determine the percentage of difference of shrinkage between when the clay is fired and before it has been fired. So that the size of the gap between bamboo and clay material can be accounted for and the shrinkage tolerance size can be documented.

## 3. Result and Discussion

### 3.1. Result of heat resistant material coating experiment on bamboo

The experiment uses a ceramic fibre blanket as the insulation material to protect the bamboo so that it does not burn and turn into charcoal. The ceramic fibre blanket used has a thickness of 6-12mm. The ceramic blanket is made from alumina-silica-zircon and is used generally for industrial uses where it is used to insulate equipments from high temperature. The experiment uses the heat insulation blanket to cover the bamboo components entirely.

To add the heat resistancy to high temperature during firing in the kiln, the bamboo material is first coated in with sodium polyacrylate material, the thickness of this material used is  $\pm 0,5\text{cm}-1\text{cm}$ , then it is covered with the ceramic fibre blanket, To keep any hot air from passing the insulation material, the whole surface must be completely covered.

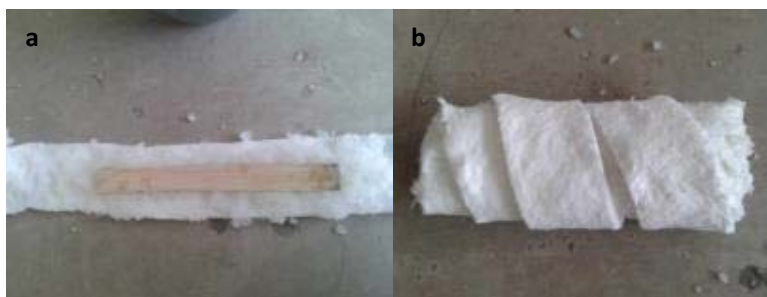
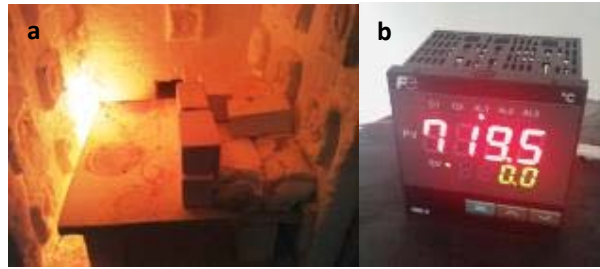

Figure 5(a) Ceramic fibre blanket and sodium polyacrylate; (b) Bamboo material ready to kiln process



**Figure 6(a) Burning process inside the kiln; (b) Temperature indicator ( $\pm 700\text{C}$ )**

The experiment process uses bamboo with two thickness (4mm and 8mm) blades which has been covered with the sodium polyacrylate and ceramic fibre insulation materials which are then fired up in the kiln with a temperature of  $700^{\circ}\text{C}$  for 4 hours. The experiment shows that during the firing there are no changes to the bamboo material with the thickness of 8mm, it is not burned at all. The 4mm bamboo blade however shows some burning at the edges because the covering insulation material was not covering the bamboo material sufficiently which causes hot air to come into contact with the bamboo and burns it.

To find out how thick the sodium polyacrylate and ceramic fibre needs to be to protect the bamboo material, a couple of experiment is done with various thickness of insulating materials. The different thickness of the insulating materials is then fired in the kiln for 4 hours with a temperature of  $700^{\circ}\text{C}$ . The results can be seen in table 1.

Table 1. Results of experiment on various thickness of insulation materials

No	Thickness of insulation materials (sodium polyacrylate and ceramic fibre blanket coating)	condition of bamboo material
1	$\pm 3\text{ mm}$	burnt and turned into charcoal
2	$\pm 6\text{ mm}$	burnt and turned into charcoal
3	$\pm 12\text{ mm}$	Unburned
4	$\pm 18\text{ mm}$	Unburned

From the experiments shown in Table 1, the effective thickness of the insulation material to protect the bamboo so that it is not burnt within the kiln temperature of  $700^{\circ}\text{C}$  is  $\pm 12\text{ mm}$  -  $\pm 18\text{ mm}$ . This thickness will be used as standard for the following experiments, which is the firing of the bamboo and clay material at the same time.



**Figure 7. The result of kiln process,  $\pm 12\text{ mm}$  sodium polyacrylate and ceramic fibre blanket coating layer, bamboo thickness 4 mm.**



Figure 8. The result of kiln process,  $\pm 12$  mm sodium polyacrylate and ceramic fibre blanket coating layer, bamboo thickness 8 mm.

The kiln that is going to be used for the firing only has 1 heat source which is at the back, this causes the temperature to be hotter at the back of the kiln than the front, this heat can cause the protecting insulation material to not work optimally. From the experiments done to minimize the burning of the edges and surfaces of the bamboo material during the firing process inside the kiln, the placing of the bamboo material must be further away from the source of heat of the kiln.

### 3.2. Result of the tableware product experiment

The type of tableware product that will be made from the clay that is combined with bamboo is containers to store eating utensils such as forks, knives and water. For other components parts using bamboo, it will be made from bamboo using the cold press lamination system with inline lamination pattern (Sulastiningsih 2014) the thickness of the laminated material is 10 mm, to form the component so that is more ergonomic and easy to handle and hold, and joined with the clay material (Oka 2008), the laminated bamboo will be shaped and bended into a 90° angle.



Figure 9. (a) Bamboo laminated bending mold; (b) Cold press bending process

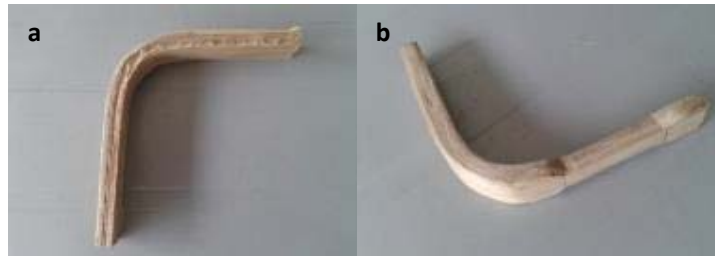

Figure 10. (a) Bamboo laminated bending; (b) Handle component from bamboo laminated

The connection and joint that will be used to join the two materials, uses the shaping of the clay as the binding connection of the handle of the tableware product. The process of applying the heat resistant material have to be twice as much for the bamboo material that is in direct contact with the clay materials surface. This is because when fired in the kiln, the clay material can retain heat up to 1400°C (Purnomo 2014). By using the clay properties that have a shrinkage property when it is dried and when it is fired. The humidity of the clay is reduced when it is air dried (air shrinkage) and when it is fired (kiln shrinkage) is used to make a bond between the clay component and the bamboo component, so that it is bonded permanently. Clay has a shrinkage percentage of

5-15%. To keep the clay component from cracking during shrinkage, there has to be a tolerance between the bamboo and clay component.



**Figure 11. Clay that has been shaped into tableware product, ready to be joined with the bamboo component**



**Figure 12. Joining of bamboo component (handle) and clay component**



**Figure 13. Detail joining component handle and clay component**

Before the firing in the kiln can be done, the bamboo component must be covered completely with the heat insulating materials, it is covered with 5mm of sodium polyacrylate and then covered with the ceramic fiber material. For the part that touches directly with the clay material, it will need extra insulating material on the out side because the gap tolerance between the clay and bamboo is small (4mm) This could cause the insulating material to not work optimally. The next process is to fire the joined components in the firing kiln for 4 hours with a temperature of 700°C. This firing process will turn the clay into ceramic.

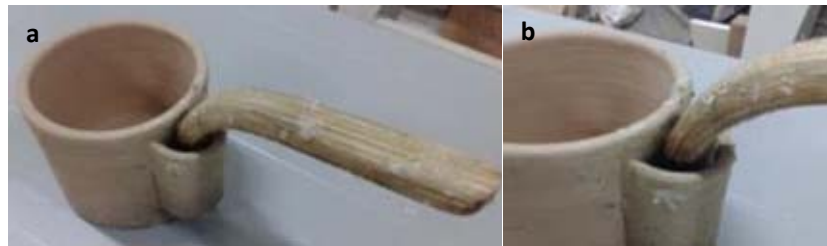

**Figure 14, Bamboo component that has been covered with insulating materials**



**Figure 15. Bamboo and clay component position inside the kiln and ready to burning process**

With the hybrid firing process in the kiln, the clay material component can physically turn into ceramic after being fired for 4 hours with a temperature of 700°C. The part that functions as the joint has a shrinkage of 5% from the size before it has been fired. For the bamboo material component, there is deformation from being burnt at the edge and sides of the handle component where it physically touches with the now ceramic part. From the analysis it is shown that the damage happens because the part is not sufficiently covered by the heat insulation materials, because the heat can go between the edges of the joining part of the clay component. This happens because the gap tolerance is small (4mm) and the effective insulation materials that can be applied is only  $\pm 3$ mm in thickness. End result of experiment can be seen in figure 16.



**Figure 16. (a) Final result after burning process finished; (b) The joint between bamboo and ceramic material become burnt after burning process finished**

### 3.3. Conclusion

There need to be further experiments and research regarding this hybrid clay bamboo material process so that the end product can be more optimal in the process and so that it could be used to develop more innovative ceramic bamboo product developments. The research and further experiments needed are:

- The use of other materials than sodium polyacrylate and ceramic fibre blanket that could withstand the firing temperature of 700°C-1000°C with the thickness of the insulation to be less than 10mm.
- Development of locking joint design of the clay and bamboo material so that the design can lock both material component more effectively.
- Further experiments for the finishing process of the materials after the firing process in the kiln.
- Further developments are needed to develop more designs with other use and functions from this hybrid process.



## References

- Book:** Widjaja, E. (2001). Identikit Jenis-Jenis Bambu di Kepulauan Sunda Kecil, Puslitbang Biologi-LIPI, Jakarta, Indonesia.
- Book:** Suhaily, S. (2013). Bamboo Based Biocomposites Material, Design and Applications, INTECH, ISBN 978-953-51-1140-5.
- Book:** Kigomo, B. (2007). Guidelines for Growing Bamboo, KEFRI Guideline Series No. 4 - April 2007, Kenya Forestry Research Institute, Kenya.
- Journal Article:** Oka, G. (2008). Analisa Arah Laminasi Vertikal Dan Horisontal Terhadap Perilaku Lentur Balok Bambu Laminasi, Jurnal SMARTek Vol 6 No 2, Mei 2008, Jakarta.
- Journal Article:** Kementerian Perdagangan RI, (2011). Menggali Peluang Ekspor Untuk Produk Bambu. DJPEN/MJL/002/12/2011 Edisi Desember, Jakarta.
- Journal Article:** Mayasari, A. (2012). The Diversity of Bambu Types And Its Utilization in Alas Purwo National Park, Info BPK Manado Volume 2 No 2, Desember 2012, Manado.
- Journal Article:** Sulastiningsih, I. (2014). Effect of Layer Orientation Composition on the Properties of Bamboo Composites Lumber, Jurnal Penelitian Hasil Hutan Vol. 32 No. 3, September 2014, Jakarta.
- Journal Article:** Purnomo, A. (2014). Analisis Bahan Keramik Prifilit Sebagai Pengganti Logam Pada Ketel Rice Cooker, Jurnal PELITA, Volume IX No 1, April 2014, Yogyakarta.
- Journal Article:** Raghuram, B. (2016). Synthesis of Non-Toxic and Biodegradable Flame Retardant Using Diapers, International Journal of Engineering Science and Computing, March 2016.
- Conference paper:** Ardhyananta, H. (2012). Karakterisasi dan Sifat Mekanik Bambu Ori dan Bambu Petung. Seminar Nasional Pascasarjana XII ITS 12 Juli 2012, Surabaya.
- Websites:** Studio Keramik PPTK Seni dan Budaya, (2012), Yogyakarta. [http://www.studiokeramik.org/2012\\_01\\_01\\_archive.html](http://www.studiokeramik.org/2012_01_01_archive.html), Last Accessed 26 January 2012.

---

**“BAGASSE BAMBOO CONCRETE” WASTE UTILIZATION OF CANE  
AND BAMBOO FIBER FOR COMPOSING MATERIAL NATURAL  
FIBROUS CONCRETE**

**Muhammad Dzulfiqar Rizwanda Putra<sup>a</sup>, Alfangga Desmontha Asmarayuda<sup>b</sup>**

*<sup>a</sup>Institut Teknologi Sepuluh Nopember, Griya Bhayangkara Kav. Timur  
No.10, Sidoarjo(61258), Indonesia*

*<sup>b</sup>Institut Teknologi Sepuluh Nopember, Pantai Mentari H-4, Surabaya(60123), Indonesia*

---

**Abstract**

Concrete has brittle properties, fiber is new manifestation of the binder capable combination with portland cement in bonding matrix to increase tensile strength. ACI:C-544 mentioning the use of natural fibers has proven to be alternative fibrous concrete material. In April 2015, Prof.V.M.Patel research the application of bagasse fiber as a composite material rigid pavement. Optimum bagasse (through tensile and compressive trial) is 1:90 with volume fraction 1% from cementitious materials. In 2010, Rusyanto and team research tensile and compressive assesment bamboo fiber with aspect ratio 1:100 and the optimum volume fraction occur in fiber is 1,5%. With these references, we utilize combination cane and bamboo fiber as concrete constituent material to improve mechanical properties of concrete. Method of test object using SNI 03-6468-200 or ACI:211.4R-93. Trial was conducted on mechanical properties of concrete about tensile and compressive. To know which variable are the optimum, we make 4 variable mix. This research evaluated from high fsp and  $f_c'25$  MPa, it can be concluded that the four variations or the independent variables of concrete with combination of cane and bamboo fiber eligible  $f_c'25$  MPa and high fsp. It's proved with compressive strength approaching normal variable 29.99 MPa and tensile strength highest 3.28 MPa.

**Keywords**

fiber, bagasse fiber, bamboo fiber, compressive strength, tensile strength

---

*1.1. Preliminary*

Concrete has advantages such as relatively high compressive strength, easily shaped as desired, low maintenance cost and can be combined with other materials. On the other hand, concrete has a brittle nature, so in practice the ability to withstand tensile stress is relatively small. Historically, reinforced concrete has been given constant reinforcement to withstand tensile stresses in the critical region of a concrete road. In addition, the steel reinforcement is adopted to cope with potentially large tensile stress

and shear stress in the critical region of a concrete road. Although the addition of steel reinforcement significantly increases the strength of the concrete, the development of micro cracks should be controlled to produce concrete with homogeneous tensile properties. [7] The introduction of fiber as a solution to develop concrete properties of concrete by improving the bending strength and tension. Fiber is a new manifestation of the binder capable combination with Portland cement in a cement matrix bonding (Sivaraja et al. 2010).

[2] According to ACI Committee 544 (1988), some studies indicate that fiber can increase the shear capacity (tensile strength) of blocks of concrete or mortar. Many fibers have been used to strengthen a variety of building materials, until now a little scientific effort has been devoted to the use of natural fibers for reinforcement. The use of some of the best natural fibers and is known as: sisal, coconut, bagasse, banana, oil, etc.

[2] As quoted in the ACI:C-544 that has been called the use of natural fibers has proven to be an alternative material fibrous concrete, and mentioned that bamboo has a high quality compared to other natural fibers because it has several advantages such as: tensile strength is relatively high, fast growth and easily cultivated especially in tropical regions such as in Indonesia. The quality varies inversely with bagasse fiber, which has a relatively lower quality of bamboo but has a bonding strength that is almost like bamboo fiber, furthermore sugar cane is also easy to grow in Indonesia and the result residue can be easily found in the excess of the production of sugar and sale of sugar cane juice.

## 1.2. Basic theory

- *Natural fiber-reinforced concrete*

[3] Fiber is a new form of binding material that can be combined with portland cement in the bond of cement matrix, to increase the tensile strength by delaying the crack growth, and increase the resilience by using tension transmission at the crack so that the deformations produced are much larger and could exceed its tension peak than without fiber reinforcement. Figure 1a. shows the increase of strength and toughness of the fiber of reinforced concrete in bending conditions, while figure 1b. describes an increase of toughness in compression, in which the compressive strength does not get too affected. [4] Fiber reinforcement can improve the impact strength of the fatigue strength, and also reduces shrinkage. (Neville, 2010).

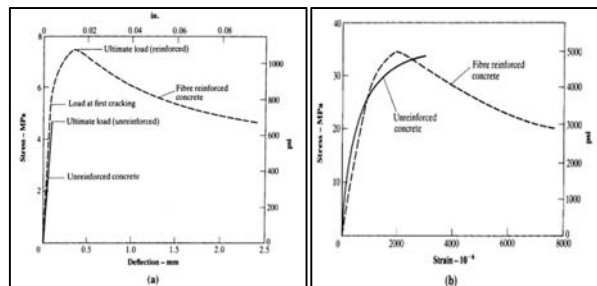

**Figure 1. The stress - deformation behavior is typical of fibrous concrete and concrete without fiber: (a) In the circumstances of bending on the beam ( b ) in compression on a cylindrical test object**

[2] Concrete reinforced with natural fibers generally called natural fibrous concrete . Many natural reinforcement materials can be obtained at a low cost and small energy, and we can use the manpower and local technical knowledge. The use of some of the best natural fibers that has been well known such as: sisal, coconut, bagasse, banana, palm oil, etc., which have been largely limited to the production of: fabrics, ropes, mats, etc. (ACI 544.16-96)

- *Natural fibers and its availability in Indonesia from bagasse and bamboo*

### Sugarcane Bagasse

Sugar cane as raw material for sugar industry is one of plantation commodities that have a strategic role in the economy field in Indonesia. The development of sugarcane production in Indonesia over the past three years has been quite volatile. In 2011, the production of sugarcane (sugar equivalent) reached 2.24 million tons and rose about 15.53 percent in 2012 to 2.60 million tons. In 2013 sugarcane production decreased by 1.46 percent to 2.55 million tons. The development of sugar cane production Indonesia in 2011 through 2013 can be seen in Table 1.

**TABLE 1 THE DEVELOPMENT OF INDONESIAN SUGARCANE PRODUCTION (TON)**

Tahun / Year	PRV Smallholders	PBN Government Plantation	PBS Private Plantation	Jumlah/ Total	Pertumbuhan/ Growth (%)
(1)	(2)	(3)	(4)	(5)	(6)
2011	1 284 229	375 001	584 924	2 244 154	-
2012	1 445 053	407 944	739 564	2 592 561	15,53
2013*	1 389 434	431 286	754 034	2 554 754	-1,46

\* ) Angka Sementara / Preliminary Figures

Source: The Central Statistics Indonesia,

The biggest sugarcane production in Indonesia is from East Java province which is 1.24 million tons, or 48.73% of sugarcane production in Indonesia. Meanwhile the province of Lampung is the second biggest with a production of 744.64 thousand tons or 29.15 %, followed by Central Java with 237.94 thousand tons or 9.31 % and West Java 99.26 thousand tons or 3.89% (Firm Bureau of Statistics Indonesia, 2013). To find out how to get the process of bagasse can be seen in Figure 2 below:

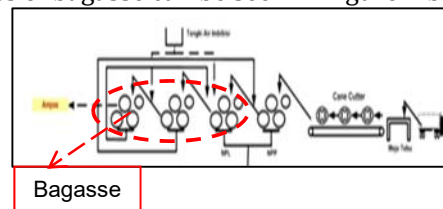

**Figure 2. Sugarcane milling process to production of sugar**

From the figure 2, it can be concluded that the bagasse is the remnant / residue from the mill of sugarcane molasses sugar cane is processed to manufacture.

From the exposure of the facts about the availability of bagasse in Indonesia, the potential to make natural fibers fibrous concrete is likely to occur. With the utilization of bagasse fiber for composite materials of concrete, waste bagasse can be reduced, so that creates a clean environment and environmentally friendly concrete technology.

### Fiber Bamboo

Agriculture Census of 2003 (ST03) showed that bamboo is more commonly planted in Java, which reached 29.14 million families, or approximately 76.83 % of the total population of bamboo in Indonesia, while the remaining is approximately 8.79 million families (23.17 %) are not planted in Java. Bamboo in Java is concentrated in three provinces, which are in West Java (28.09 %), Central Java (21.59 %) and East Java (19.38 %), while in the other Islands, in South Sulawesi (3.69 %)

Bamboo plant agricultural households (household effort BMU) in Indonesia in 2003 revealed that 521.52 thousand population clumps cultivated as much as 22.84 million. From 521.52 thousand farming household bamboo, about 74.62 percent (389.17 thousand) households are in Java, while the remaining approximately 132.35 thousands

are in other islands. For more details about the population of bamboo in Indonesia can be seen in Table 2 and the following figure 4:

TABLE 2 AVAILABILITY BAMBOO IN INDONESIA

No.	Province	The area of land bamboo (hectare)
1.	Bali	251
2.	NTB	169
3.	NTT	313
4.	DIY	225

Source: Analisis dan Data, 2011 (Executive Summary Kajian Sosekling Penerapan Bahan Bangunan untuk Perumahan Tradisional)

From the exposure of the facts about the availability of bamboo in Indonesia, the potential to make natural fibers fibrous concrete is likely to occur. With the utilization of bamboo for natural fiber composite material of concrete, creating a green alternative technology. For the physical form of a piece of bamboo that can be used as natural fibers we can see in the figure below:

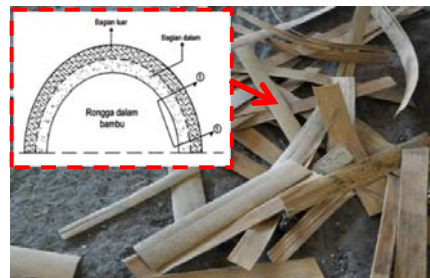

Figure 5. The outer skin of bamboo as a natural fiber material (Source: Doc. Personal, 2015)

## RESULT AND DISCUSSION

From the explanation of the results of our study in this paper, the following are the results of our research:

1. Specifications and threatment natural fiber bagasse and bamboo we used are as follows

### A. Cane Fiber

The kind of specifications	Wear	Standard
The fiber	The dregs of the cane fiber	ACI 544 1R-96
Origin fiber	Sidoarjo and Gresik	-
Ratio aspect	90	Prof V M Patel 2015
Diameter	1,5 mm	Prof V M Patel 2015
Length	60 mm	Prof V M Patel 2015
Volume fraction	1% form binder	Prof V M Patel 2015

### B. Fiber Bamboo

The kind of specifications	Wear	Standard
The fiber	The dregs of the cane fiber	ACI 544 1R-96

Origin fiber	Sidoarjo	-
Ratio aspect	100	Sunaryo 2010
Diameter	0,2 mm	Sunaryo 2010
Length	20 mm	Sunaryo 2010
Volume fraction	1,5% form binder	Sunaryo 2010

2. BBC concrete applications based on the standard of PU 2007 and recommendation of Mustafa K. Sonasath 2013.
  - a. According to PU 2007, BBC concrete with  $f_c'$  25 MPa classified as medium quality, with its use as: Bridge floor plating, reinforced concrete girders, diaphragms, precast concrete curbs, culverts and buildings of reinforced concrete under bridges.
  - b. According to Mustafa K. Sonasath 2013, BBC concrete constituent material is recommended for a wide variety of structural elements such as: Aircraft Runways, Dam Walls, rail sleepers, and quay walls. In which structural elements are getting an enormous burden with both pulling and pressing as well as the load working continuously and also shock. To anticipate both macro and micro crack fibrous concrete is used.
3. Here is a summary of the analysis results of compressive strength and tensile, from these results it can be seen that the BBC concrete or a combination of cane and bamboo fiber is the optimum variable compared to other variables

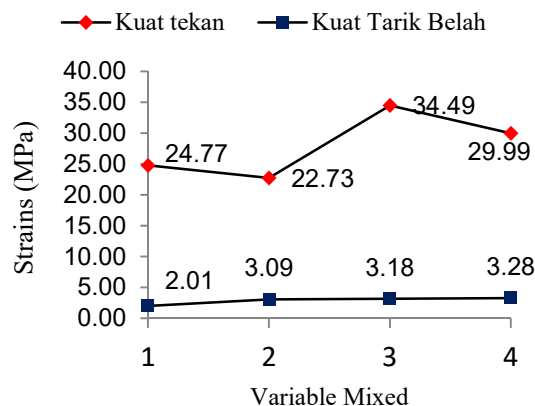

Note: Variation Mixed: 1 (Normal) , 2 (Sugarcane Fibre) , 3 (Bamboo Fiber) , 4 (Combination Fiber Cane and Bamboo)

4. [1] Calculation of the composition of the concrete mix of the bamboo bagasse concrete (BBC) refers to the standard ACI: 211.4R - 93 or SNI 03-6468-2000. With 2 parts: part 1. Calculations of concrete mix design only, then part 2 fiber volume fraction put into the mix design, so that the natural fiber content for the manufacture of fibrous concrete.
5. The method of implementation and testing in concrete manufacture BBC is the same with normal concrete production, but there are several additional processes which are needed in manufacturing and testing, such as:
  - a. Natural fibers are added into the freshly mixed concrete
  - b. Testing is also done to hard concrete tensile strength dimpled or split testing

## CONCLUSION

From the explanation of the results of our study in this paper, there are some conclusions we can take from our research results:

1. The addition of bamboo fiber and sugar cane fibers can increase the compressive strength and tensile strength.
2. The addition of bamboo fiber and sugar cane fibers can increase the compressive strength and tensile strength.
3. For tensile strength, the addition of sugar cane fibers combined with bamboo fiber increase of 61,28 % of the tensile strength of normal concrete without adding any fibers

## ACKNOWLEDGMENT

We would like to thank Laboratory of Material Civil Engineering Department of Institut Teknologi Sepuluh Nopember for providing facilities for this research. We also want to thank Allah SWT in which because of His help, we can finish this research easily. And also thanks to our parents who have provided support in the implementation of this study. Last but not least, thanks to Mr. Ridho Bayu Aji, ST.,MT.,Ph.D; our supervisor who has been providing advice and guidance in the research process.

## REFERENCES

- [1] Dr.M.Sivaraja M.E., P. P., 2010. Application of Coir Fibres as Concrete Composites for Disaster Prone Structures, Bangalore: Central Institute of Coir Technology
- [2] Institue, A. C., 2002. State-Of-The-Art Report On Fiber Rein-forced Concrete, S.L.: ACI.
- [3] Neville, A., 2010. Concrete Technology. 2nd Ed. Tottenham UK: Pearson.
- [4] Patel, P. V. M., 2015. Application of Sugarcane Bagasse Fibres as Concrete Composites for Rigid Pavement. Engineering, 4(4), Pp. 4-5.
- [5] Rusyanto, 2010. Kajian Kuat Tarik Beton Serat Bambu, S.L.: Rusyanto.
- [6] Sivaraja, M., 2009. Study On Durability of Natural Fibre Concrete Composites Using Mechanical Strength And Microstructural Properties. 33(6), PP. 719-729.
- [7] (SNI), B.S.N., 2000. Perencanaan Campuran Beton Berkekuatan Tinggi Dengan Abu Terbang.Jakarta: BSN.
- [8] Nugraha, Paul. Teknologi Beton. Andi, 2007
- [9] Subakti, A., Teknologi Beton Praktek I, Surabaya:ITSPress, 2012.
- [10] ASTM 2000, Annual Book of ASTM Standart: Concrete and Agregates, ASTM, Amerika.
- [11] Bayu Aji, 2012, Teknologi Beton dan Bekisting, Surabaya

**Topic :** Metallurgy and Materials Engineering

**Effect of Titanium Addition on Characteristic of Al6061/ Al<sub>2</sub>O<sub>3</sub>  
Reinforced Composites Produced by Stir Casting Process**

Anne Zulfia\*, Basauli Tobing, and Donanta Daneswara

Department of Metallurgy and Materials, Faculty of Engineering, Universitas Indonesia,  
Kampus Baru UI Depok 16424, Indonesia

---

**Abstract**

Al6061/Al<sub>2</sub>O<sub>3</sub> reinforced composites have been successfully produced by stir casting process. The master alloy Al6061 as a matrix composites was prepared by melting at 800 °C and mixed with various of Al-5TiB from 0.02 wt-% to 0.15 wt-%, 0.025 wt-% Al-5Sr as modifier and 10 wt-% Mg as wetting agent respectively. The addition of Al-5Ti-1B on Al6061 is to strengthen the matrix phase and Al-15Sr is to bring the effect of matrix modification. The role of Al-5Ti-1B is to be grain refinement agent which mainly provides more nucleating sites and restricts the growth of grains and the role of Al-15Sr is to be a modifier of the morphology of the second-phase particles. The molten aluminium then flushed with argon to remove all the gas bubble from liquid aluminium, then stirred for 3 minutes to produce a perfect vortex flow, afterwards Al<sub>2</sub>O<sub>3</sub> was poured and stirred again for 3 minutes. The composites produced then characterised both mechanical properties and microstructural analysis. The optimum mechanical properties of composite is obtained at 0.02 wt-% Ti addition with tensile strength of 204 MPa and elongation of 11.75 % at 0.09 wt-% Ti, while hardness is 50 HRB. These preferable properties are also supported by perceiving its microstructure. The role of Al-5Ti-1B is to be grain refinement agent which mainly provides more nucleating sites and restricts the growth of grains. It is obvious that the smaller-fragmented area of aluminium and finer morphology of the second phases contributed to increase mechanical properties

**Keywords :** Al6061; Al<sub>2</sub>O<sub>3</sub> particles; Al-5TiB; composites; stir casting

---

**1. Introduction**

Technology of materials is significantly being an important demand for the human being to provide their needs and ease their activities for nowadays. The development of technology nowadays needs material's properties that can not be found in metal, polymer, and ceramic themselves. This properties cover high specific strength, high temperature creep resistance, and better fatigue strength, therefore composite is

---

\* Corresponding author. Tel.: +62-021-7863510; fax: +62-7872350.  
E-mail address: anne@metal.ui.ac.id



made (Akio et al, 1999 and Mussert et al, 2002). This material will be used for application that need high performance such as automotive, military and aerospace industries. For instance, the demand for more lightweight materials, fuel efficient and enhanced performance automobile stimulates the research and development of many materials have to be fulfilled by the automotive industries (Bussines Market, MMC,2013).

One of the recent research is carried out to improve mechanical properties with high performance and lighter weight. The present study has been subjected to extensive research of using Al alloy to be developed as aluminum matrix composite which is combined with ceramic particles reinforced. The most common Al alloy used for automotive application, is Al alloy 6 series wrought product which consists of Mg and Si as its prime constituents [Dobrzanski and Woarezyk, 2005]. Al-Mg-Si is generally used in structural, aircraft, nuclear application and etc (Calister, 1994) because it has medium strength among other Al alloys, which is about 185 to 215 MPa (Anne, 2013). This number of strength is considered to be sufficient for the strength required before being continuously treated. For it has major constituents of Mg and Si, so it categorizes as the heat-treatable alloy and subsequently be increased in strength (Mitchell, 2012). The selection of Al-Mg-Si alloy is also due to the strengthening process that might be involved. For instances, it could be subjected to solid solution strengthening, grain refinement strengthening and aging process to enhance its mechanical properties according to its application (Anne and Maman, 2011). While aluminium composites is considered to improve such mechanical properties by adding ceramic particles. In general, ceramic material which is selected for being the reinforcement is  $Al_2O_3$  particles. The particles-type of reinforce is chosen by its isotropic characteristics which tends to be more durable if being fabricated and economically in process rather than fibers and whiskers-type of reinforce (Zulfia and Hand, 2002). The addition of reinforce particles to the matrix is likely to give more strengthening effect in purpose. This will be obtained as if the reinforcement is fully wet by the matrix. Moreover, the particles-type of reinforcement is hard to be completely wet therefore need a dopant to promote wetting between Al and ceramic. Stirr casting process is selected to aid the randoly distribution of ceramic particles in molten aluminium

According to the previous research, the highest strength of composite was obtained at the composition of 10 wt% of  $Al_2O_{3p}$  with the value of 190 MPa without any additional constituents for modification (Anne, 2013). The present study is to obtain higher mechanical properties by modification of Al-5Ti-1B master alloy and addition of the modifier, Al-15Sr and the wetting agent of Mg. The amount of 0.1 wt% Ti addition in Al 6061 results in about 185 to 215 MPa (Samuel et al, 2014). At the same point, the optimal Ti addition to the composite 6061/ $Al_2O_{3p}$  which is below 0.05 wt% gives  $198.5 \pm 10.2$  MPa of the yield strength and  $264.3 \pm 5.1$  MPa UTS, respectively (Zhiqiang et al, 2005). Therefore, this present study is in purpose to define the optimum amount of Ti addition from 0.02 to 0.15 wt% to give remarkable mechanical properties.

## **2. Experimental Procedure**

### *2.1. Making of Al6061/ $Al_2O_3$ composites*

The composites in this study were prepared from the rod of Al 6061 alloy, Al-5TiB and Al-15Sr as master alloy matrix, 10 wt% Mg ingot (99.99%) as a wetting agent, and 10 Vf% of  $Al_2O_3$  particles with size of  $65\mu m$  as reinforcement. The raw materials, Al 6061 alloy ingots were melted in electric furnace at  $800^\circ C$ , then Al5TiB and Al15Sr were added into molten aluminium then stirred at 415 rpm for 3 minutes and flushed with Argon for 1 minute. The Al5TiB used was various from 0.02 to 0.15

wt%, while Al-15Sr was constant at 0.03wt%. At the same time, the Al<sub>2</sub>O<sub>3p</sub> was preheated in the furnace at 1000 °C for approximately one hour to decrease all moisture on the surface of particles. The chemical composition of the Al 6061 ingots were analyzed by Optical Emission Spectroscopy is listed in Table 1.

Table 1. The composition of Al 6061

Alloy	Al	Mg	Si	Cu	Mn	Sr	Ti	B	Fe	Cr
wt%	96	2.69	0.819	0.217	0.0168	<0.0001	0.0073	<0.0005	0.161	0.0577

After the Al ingots being fully melt, the process of degassing was carried out for 2 to 3 minutes by argon. The molten alloy was held and stirred for 3 minutes to homogenize the composition. Next was the preheated Al<sub>2</sub>O<sub>3p</sub> mixed to the molten alloy and continuously being stirred to aid the randomly distribution of Al<sub>2</sub>O<sub>3p</sub> in the molten matrix. The stirring process was also followed by the degassing process to ensure all the gas remove from the aluminium molten. After all of the processes finished then the molten composite was being casted to the SKD61 -metal mold and it was cooled in the air.

### 2.2. Characterization of AlA356/ Al<sub>2</sub>O<sub>3</sub> composite

The mechanical properties of composites were measured including tensile strength, hardness, density, porosity, and wear resistance. Tensile testing was carried out using GOTECH AI-7000 LA 10 in accordance with ASTM E8M-09. The tensile testing was carried out using three specimen each variable. Hardness testing was carried out using Rocky machine with Rockwell B method in accordance with ASTM E18-11. For each sample, five hardness readings on randomly selected regions were taken in order to eliminate the segregation effects and get a representative value of the matrix material hardness. The porosity of composite was measured using Archimedean method. The microstructure of composites was analysed following the metallography procedure, the samples representative was prepared by grinding using emery paper started from 80#, #150, #240, #400, #600, #800, #1000, #1200 to #1500, then polished using alumina powder to remove strach from grinding process, then etched with 0.5% HF for 1 minute. All samples preparataion were observed using OLYMPUS BX41M-LED optical microscope and further analysys using Scanning Electron Microscope (SEM).

## 3. Results and Discussion

### 3.1. Chemical composition of Al6061/Al<sub>2</sub>O<sub>3</sub> cast composites

Table 2 shows the chemical composition of Al6061/ Al<sub>2</sub>O<sub>3</sub> composite analysed by Optical Emission Spectroscopy (OES). The composition design was different from OES result. The Mg content should be 10wt% or less but the OES measured was 12wt%, while Ti closed to material balance which was design before casting but for Sr the OES measured was strayed away from designed alloy. It is assumed that deviation can be caused by the over reading of the instrument to measure the Mg and Sr content inside of the material.

**Table 2.** Chemical composition of Al6061/Al<sub>2</sub>O<sub>3</sub> cast composites (wt-%).

Composites	Mg	Si	Ti	B	Sr	Cr	Fe	Mn	Al
1	>12	0.57	0.02	<0.0005	0.03	0.25	1.04	0.05	Bal
2	>12	0.56	0.03	0.01	0.03	0.33	1.50	0.06	Bal
3	>12	2.49	0.09	>0.025	0.065	0.271	1.62	0.766	Bal
4	>12	2.14	0.122	>0.025	0.047	0.198	1.42	0.769	Bal
5	>12	2.00	0.15	>0.025	0.048	0.328	1.62	0.60	Bal

### 3.2. Effect of Ti on mechanical properties of Al6061/ Al<sub>2</sub>O<sub>3</sub> composite

The mechanical properties of Al6061/Al<sub>2</sub>O<sub>3</sub> such as tensile strength, elongation and hardness are shown in Figure 1. They are seen that composites with 0.09 wt-% Ti addition has the highest both tensile strength and elongation (Fig. 1a,b), even though the addition of 0.02 wt-% Ti has the highest strength with the value of 204 MPa. The hardness of composites is 50 HRB which is optimum obtained at 0.12 wt-% Ti addition. There are many factors can cause the highest of mechanical properties, some of them might be the distribution of the Al<sub>2</sub>O<sub>3p</sub>, the porosity formed in the composites, the wettability of the matrix, and the formation of intermetallic compounds. The addition of Ti in the as cast composite is to be known for the effect of grain refinement. It brings the effect of refinement by heterogeneously nucleating the TiAl<sub>3</sub> and TiB<sub>2</sub> and restricting the growth of the grains (Kashyap and Chandrasekar, 2001). Heterogeneous nucleation involves peritectic reaction. The result of peritectic reaction, TiAl<sub>3</sub> and TiB<sub>2</sub>, will become nucleates and continuously become sites for nucleus of Al. This condition subsequently will give more nucleating process rather than growing process of the Al. Thus, the process of refinement consists of two mechanisms, first is serve nucleating sites for Al nuclei and restrict the growth of Al. Boron is also counted as the refinement agent because it reacts along with Ti to form TiB<sub>2</sub> which are insoluble in Al. Even so, the superior effect of refinement is still generated by the formation of TiAl<sub>3</sub> intermetallic compound because it is believed that the lattice disregistry of TiAl<sub>3</sub> is smaller than TiB<sub>2</sub> (Sigworth and Johnsson, 1993).

The refinement will result to the finer grain of matrix Al generates the remarkable mechanical properties. Besides, the addition of Al-15Sr will also result good modification to the formation of the second phases. In this study, the Ti addition up to 0.02wt% and constant number of 0.03wt% Sr gives the highest UTS among other samples. It is firstly concluded that the refinement process takes place in the as cast composites.

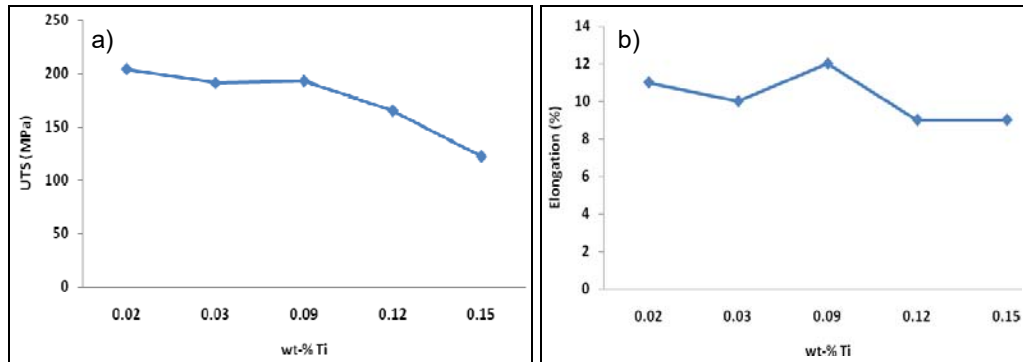

Figure 1. Mechanical properties as-cast Al6061/Al<sub>2</sub>O<sub>3p</sub> composites. a) Tensile Strength, and b) Elongation,

The hardness and porosity are shown in Figure 2. The highest number of hardness is obtained in composite with 0.12 wt-% Ti with the value of 50 HRB, and the lowest porosity is obtained at 0.09 wt-% Ti. The effect of Ti on grain refinement of Al has good impact to increase hardness. The other factor matters to the properties except the refinement process is the casting process. It will result casting defects, such as formation of shrinkage and porosity which deteriorates the mechanical properties. It seems that the addition of 0.09 wt-% Ti has high tensile strength, elongation and hardness due to the lowest of porosity. But here the highest UTS which is obtained at 0.02 wt-% Ti shows higher number of porosity than that of 0.09 wt-% Ti. This contradicts with the theory that the small number of porosity will give higher strength. Perhaps stress concentration that brings negative effect to the composite.

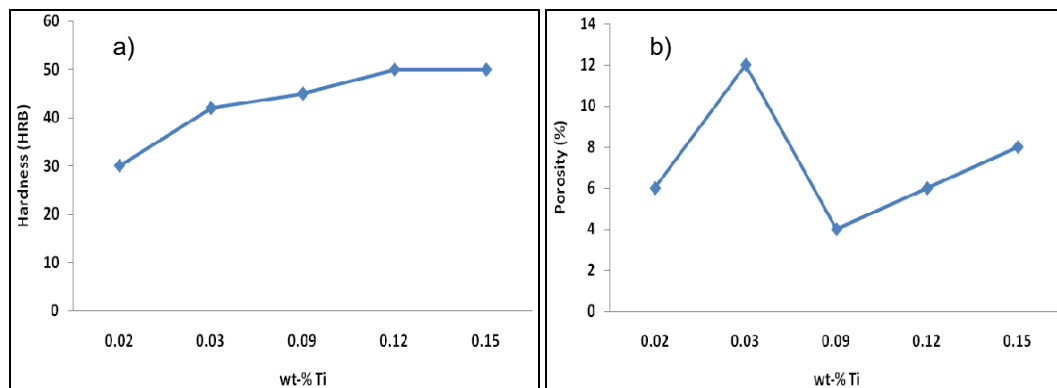

Figure 2. Mechanical properties as-cast Al6061/Al<sub>2</sub>O<sub>3p</sub> composites.. a) Hardness, and b) Porosity

### 3.3. Effect of Ti on microstructure of Al6061/ Al<sub>2</sub>O<sub>3</sub> composite

The microstructure of the as-cast Al-Mg-Si/Al<sub>2</sub>O<sub>3p</sub> composites was examined using optical microscope in Figure 3. The most obvious difference between the as-cast unmodified and modified one is the structure of the matrix for each. The dominant structures of the modified ones are the likely-fragmented dendrites of Al and the fragmented-to-globular like of Al (Fig.3b). From these kind of morphology, it could be stated that the addition of Ti and Sr plays an important role which will definitely affect their properties. The inter-dendritic area has also been an important thing to be noticed that it is related to the formation of other constituents at the condition of as - cast

(Bartłomiej and Bogusława, 2015). For the composites 1 and 3, the difference are shown at the area of inter-dendritic which becomes smaller.

The fragmented area of dendritic is shielded by constituents as the second phases at its inter-dendritic area. These second phases formed at the inter-dendritic are predicted as the quaternary of Al, Al<sub>3</sub>Fe, Al<sub>3</sub>Mg<sub>2</sub>, Mg<sub>2</sub>Si (Liu et al, 1999). This quaternary eutectic blooms out as the network-like according to its solidification path, which is clearly shown by the arrow see Fig.4. The solidification path of this quaternary eutectics is commonly shown by the quaternary diagram of Al-Fe-Mg-Si because of the high presence of Fe in the rod (Belov and Eskin, 2005). The prediction to be the quaternary phases is due to the morphology shown according to the atlas of microstructure. The transition of smaller inter-dendritic area from Fig. 3a to 3b verifies that there is combination by the presence of Ti and Sr (George Van Der Voort, 2004).

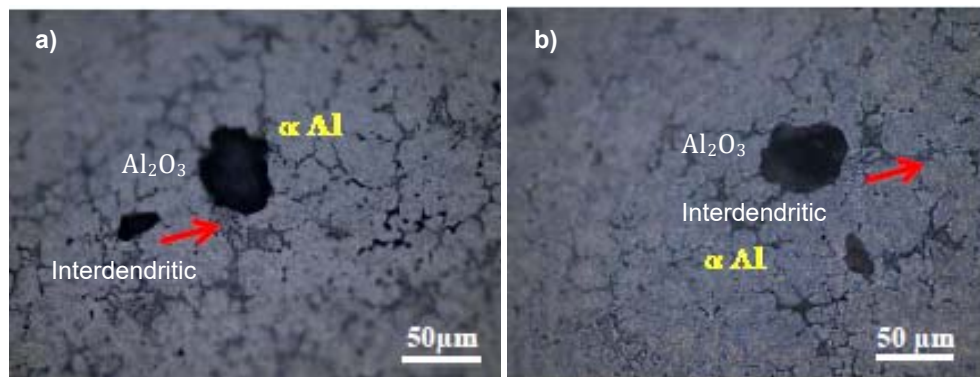

Figure 3. Microstructure of as-cast Al6061/Al<sub>2</sub>O<sub>3p</sub> composites with composition 1(a) and 3 (b)

When the microstructure is seen at lower magnification, both composites clearly exhibit other constituents which are represented in Fig. 4. The needle like indicates the phase of Al<sub>3</sub>Fe. This morphology of Al<sub>3</sub>Fe is commonly alike to the morphology of Al-Fe-Si with shorter appearance. Then, the second particles and snow flakes are predicted to be Al<sub>3</sub>Mg<sub>2</sub> and Mg<sub>2</sub>Si, respectively. All of these predicted constituents were according to its possible solidification sequence by the quaternary diagram and the morphology of phases is also confirmed by George Van Der Voort (see Table. 3). The presence of Ti and Sr also exhibit an important role that the morphology of each phases in composites 3 becomes smaller than that of in composite 1.

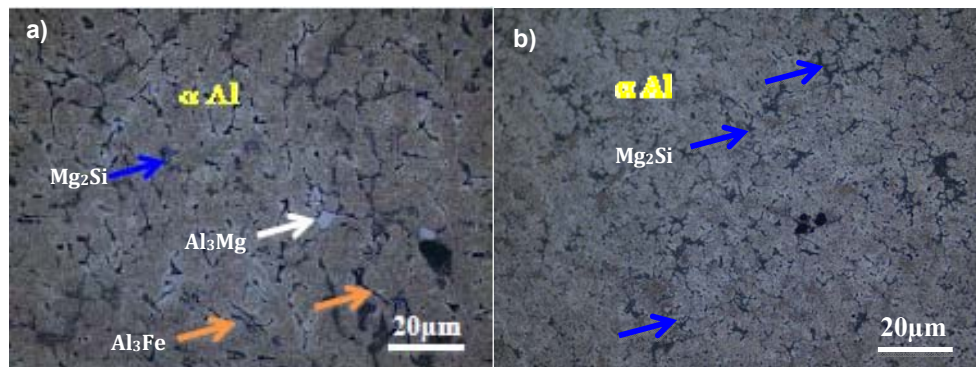

Figure 4. Microstructure of the as-cast Al6061/Al<sub>2</sub>O<sub>3</sub> composite with composition 1 (a) and 3 (b)

Table 3 : Phases identification performed according to ASM (George Van Der Voort, 2004).

Phase	Morphology
$\alpha$ Al-Fe-Si	chinese script, blocky
B Al-Fe-Si	needle, platelet
Mg <sub>2</sub> Si	chinese script, irregular, polyhedral
Al <sub>3</sub> Fe	platelet
Al <sub>3</sub> Mg <sub>2</sub>	polyhedral, irregular, rounded
Al-Si	platelet, irregular, polyhedral blocky

The transition of the Al matrix is obtained at the composition of 0.03 wt% Ti and 0.025 wt% Sr which is in the composite 2 (Fig.5). It is clearly shown that the almost fragmented-dendritic like of Al turns out into fragmented-to-globular like of Al (Fig. 5a). The case is similar to the study presented by Martorano and Capocchi et.al, 2005. The result of their study is the transformation of columnar dendritic of Cu-8Sn alloy to be globular by the addition of Cu-50Zr alloy. This is categorized to become an evidence of the role of Ti addition takes place. Al-5TiB which is added to the molten metal will act as inoculant, such as Ti<sub>3</sub>Al or TiB<sub>2</sub>. The Ti<sub>3</sub>Al dissolved and TiB<sub>2</sub> undissolved which go into solution will become nuclean for nucleus of dendritic Al and will subsequently restrict the growth of dendritic Al (Bartlomiej and Boguslawa, 2015).

Being compared to the composite 1 and 3, the most globular-like grains of Al in Fig. 5 could be examined at low magnification. It more likely indicates that refinement takes place at the Ti addition up to 0.03 wt% and the network-like which tends to be inter-dendritic area considering as chinese script Mg<sub>2</sub>Si (Fig. 5b). It is considered to the effect of modification by Sr is also ocured in this study as well as previous study by Tong Min et al, 2014.

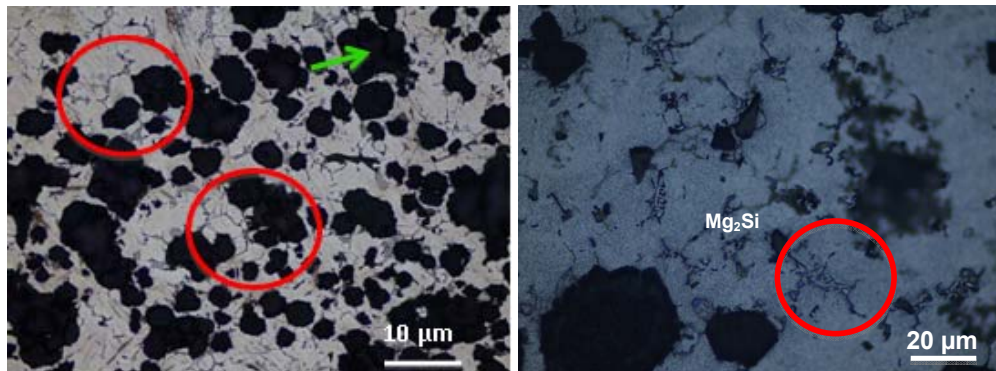

Figure 5. Microstructure of as-cast Al6061/Al<sub>2</sub>O<sub>3</sub> composites with composition 2.

The microstructure of composite 4, with Ti addition up to 0.122 wt% shows bigger globular of Al than that of composite 2 (Fig. 6a). As compared to the composite 2, this composition did not undergo appropriate refining process but it did if compared to the composite 1 and 3. The more addition of Ti which is up to 0.15 wt% represented by the composite 5 (Fig. 6b) gives deteriorated appearance in the microstructure. It is clearly shown that the globular of Al shielded by the network-like of Mg<sub>2</sub>Si becomes bigger and the microstructure also shows the formation of some deteriorated phase, like it is predicted as Al<sub>3</sub>Fe which is caused the mechanical properties become low for this composite.

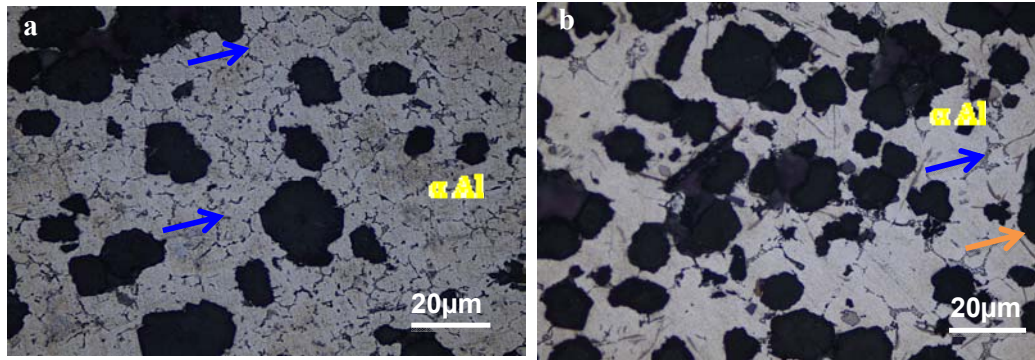

Figure 6. Microstructure of as-cast Al6061/Al<sub>2</sub>O<sub>3p</sub> composite with composition 4 (a) and 5 (b)

It could be concluded that the addition of Ti up to 0.1 wt% will not give any significant effect of grain refinement of Al matrix. It is proved by the result of its tensile strength of the samples which decreases as the number of Ti increase. It is clearly showed that the addition of refining agent has its optimum level and too much addition has it be insignificant. At some point, modification by Ti and Sr in this study is not the only thing signifying the higher strength of the composites achieve. From the level of porosity among all, composite 2 gives the higher one (Fig. 2). By gaining this result, composite 2 should had been the lowest strength rather than others, but in this study is seen odd results since tensile strength and hardness has high value eventhough still lower than composite 3. Yet it is a composite, the role of its reinforcement also plays important to raise its mechanical properties. From the micrographs of each composite, it could be seen that composite 2 has better distribution of Al<sub>2</sub>O<sub>3p</sub> (Fig. 5). All of these, such as the distribution of Al<sub>2</sub>O<sub>3p</sub>, the refinement effect, the porositycontent and phases formation will affect to the mechanical properties of composite.

#### 3.4. XRD Analysis of Al6061/Al<sub>2</sub>O<sub>3</sub> composite

The phases present in composites is represented in composition 2 are Al, AlSi, Mg<sub>2</sub>Si, AlMg, AlFe, MgAl<sub>2</sub>O<sub>4</sub> as shown in XRD analysis in Fig. 7. Refer to microstructure of composite above the phases present has been confirmed by George Van der Voort [15] and XRD analysis.

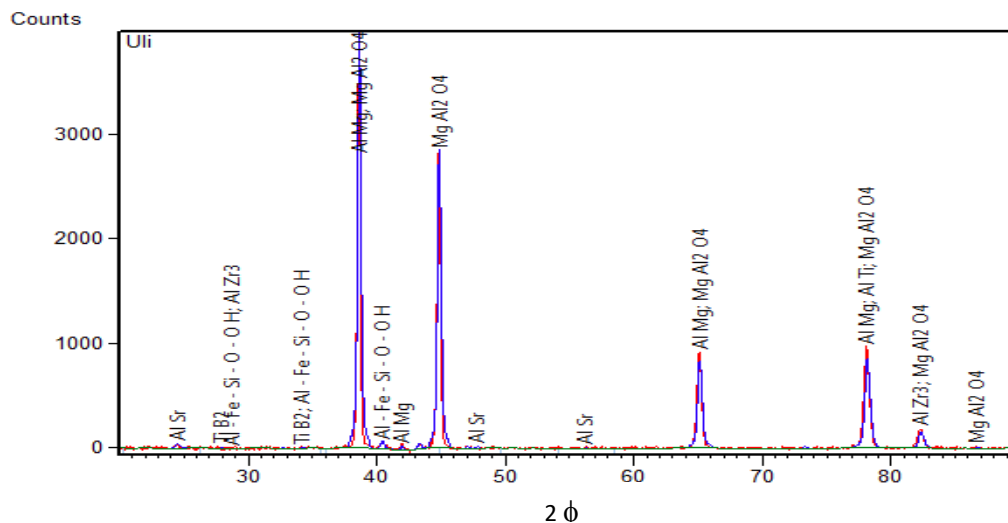

Figure 7. X-Ray Diffraction Pattern of Al6061/Al<sub>2</sub>O<sub>3</sub> Composite for composition 2

## 4 .Conclusion

Based on the results obtained in this work, there are some major conclusions that could be highlighted as follows :

1. The optimum mechanical properties is obtained in compsites with Ti addition of 0.09 wt-% both tensile strength and elongation as well as the lowest porosity content but the highest hardness found at composition of 0.12 wt-% Ti, further addition of Ti up to 0.15 wt% the mechanical properties decrease.
2. Ti addition gives transformation of each matrix Al morphology and so does Sr addition gives modification to the Mg<sub>2</sub>Si and Al<sub>3</sub>Fe phases in the form of chinese script.
3. The phases present in composites is Al, MgAl<sub>2</sub>O<sub>4</sub>, Mg<sub>2</sub>Si, Al<sub>3</sub>Fe and AlSi analysed by XRD.

## Acknowledgment

The authors would like to thanks to Higher Education, Ministry of Research and Technology and Higher Education Republic of Indonesia for financial support to do this research under PUPPT funding with contract No : 1143/UN2.R12/HKP.05.00/2016

## References

- Akio, K., Atsushi, O., Toshiro, K., Hiroyuki, T. (1999). Fabrication, Process of Metal Matrix Composite with Nano-size SiC Particle Produced by Vortex Method. *J Japan Institute Light Metals*, 49, p149 – 154.
- Anne, Z. (2013). Characteristic of Al-Mg-Si/ Al<sub>2</sub>O<sub>3</sub> Produced by Stirr Casting Procees, Research Project. Unpublished, Universitas Indonesia,
- Anne. Z and Maman, K.A. (2011), Effect of Artificial Aging (T6) on Microstructure of Al-AC8H/Al<sub>2</sub>O<sub>3</sub> MMC Produced by Stir Casting Route, *Advanced Materials Research Vols. 328-330* (2011), *Mechatronics and Materials Processing I*, pp 1552-1555
- Bartlomiej. D and Boguslawa, A.C. (2015), "The Microstructure of AlSi7Mg Alloy in As-Cast Condition," *Solid State Phenomena*, pp. 3-10.
- Belov, N. A. and Eskin, D. G. (2005), *Multicomponent Phase Diagrams : Applications for Commercial Aluminum Alloys.*: Amsterdam, Boston, Elsevier
- Business Wire. MMC Market - Global Industry Analysis, Size, Share, Growth, Trends, and Forecast 2013-2019. [Online]. <http://www.businesswire.com/news/home/2-15-323--5591/en/metal-matrix-composites-mmc-market-rides-success#.VXMbyqqko>
- Callister, W. D. (1994), *Materials Science and Engineering: An Introduction*. New York: John Wiley and Sons, Inc., vol. 3rd.
- Dobrzanski, L. A. and Woarezyk, F. (2005) "Properties and Corrosion Resistance of PM Composite Materials Based on EN AW-Al Cu4Mg1(A) Aluminum Alloy Reinforced with The Ti(C,N) Particles," in *International Scientific Conference on The Contemporary Achivements in Mechanics Manufacturing and Materials Science*, pp. 289-295.
- George F. Vander Voort. (2004), *ASM Handbook, Commitee, ASM Metal Handbook*, , Ed: ASM International, Vol. 9.
- Kashyap. K. T. and Chandrasekar. T. (2001), "Effects and Mechanism of Grain Refinement in Al Alloys," *Bull. Mat. Sci.*, vol. 24, pp. 345-353
- Liu, Y. L, Kang, S. B. and Kim, H. W. (1999), "The Complex Microstructures in an As-Cast Al-



- Mg-Si Alloy," *Materials Letter*, vol. 41, pp. 267-272
- Martorano, M. A. and Capocchi. J. D. T. (2005), "Dendrite Structure Control in Directionally Solidified Bronze Castings," Department of Metallurgical and Materials Engineering, Polytechnic School, University of Sao Paulo, Sao Paulo, 05508-900.
- Mussert, K.M., Vellinga, W.P., Bakker, S. (2002). A Nano-indentation Study on the Mechanical Behaviour of the Matrix Material in an AA6061 – Al<sub>2</sub>O<sub>3</sub> MMC. *Journal of Materials Science*, 37. p789 – 794.
- Mitchell C. A. (2012) "A Study of The Powder Processing, Tribological Performance and Metallurgy of Aluminium-Based, Discontinuously Reinforced Metal Matrix Composites,," Napier University, Edinburgh.
- Samuel. E, Golbahar. B and Samuel, A.M. (2014), "Effect of Grain Refiner on The Tensile and Impact Properties of Al-Si-Mg Cast Alloys," *Journal of Material and Design*, vol. 56, pp. 468-479
- Sigworth. G.K and Johnsson. M. (1993), "Study of The Mechanism of Grain Refinement of Aluminum After Addition of Ti- and B- Containing Master Alloys," *Metallurgical Transactions A*, vol. 24A, pp. 481-491
- Tongmin. W, Zhao. Y, and Huijun. K. (2014), "Effect of Sr on The Microstructure and Mechanical Properties of In-Situ TiB<sub>2</sub> Reinforced A356 Composite," *Materials and Design*, vol. 64, pp. 185-193.
- Zhiqiang. Y, Wu. G, Jiang. L and Sun. D. (2005), "Effect of Coating Al<sub>2</sub>O<sub>3</sub> Reinforcing Particles on The Interface and Mechanical Properties of 6061 Alloy Aluminium Matrix Composites," *Materials Letters*, pp. 2281-2284,
- Zulfia. A , and Hand. R.J. (2002), The production of Al-Mg alloys into SiC Preform in Production of Metal Matrix Composites, *Journal of Materials Science*, Vol 37.No. 5, pp.955-961



---

## **DIFFERENTIAL-FED CIRCULAR PATCH ANTENNA WITH HIGH IMPEDANCE SURFACE SUBSTRATE**

Fitri Yuli Zulkifli<sup>a</sup>, Muhammad Haekal<sup>b</sup>, Basari<sup>c</sup>, Eko Tjipto Rahardjo<sup>d</sup>

<sup>a,b,c,d</sup> *Antenna, Propagation, and Microwave Research Group (AMRG)  
Electrical Engineering Department, Faculty of Engineering, University of Indonesia, Depok*

---

### **Abstract**

Wireless technology is developing nowadays and one of the most important elements in wireless technology is the antenna. For the user, antenna usually has compact size and considers having high gain. By using High Impedance Surface structure as the substrate, it can enhance gain performance without increase dimension of antenna. In this research, planar rectangular HIS structure has been implemented as substrate of microstrip antenna with dual feeding line. The resonant frequency is 2,445 GHz with 85 MHz bandwidth.

HIS unit cell is designed and simulated to obtain the resonant frequency as shown in its reflection phase diagram. The unit cell consists of 1x2 planar array configuration is implemented in circular patch microstrip antenna using electromagnetic coupled feeding method. The antenna consists of two substrate layers. The first layer consists of circular patch and the second substrate consists of two feed lines with HIS unit cell.

Based on simulation results, in port 1 shows bandwidth of 150 MHz and 7,85 dB gain. For port 2, the bandwidth is 160 MHz with 7,98 dB gain. To validate the simulation result, measurement has been conducted. Measurement results show 160 MHz bandwidth and 7,92 dB gain in port 1, meanwhile, in port 2, shows 170 MHz bandwidth and 7,12 dB gain.

### **Keywords**

Microstrip antenna; EBG; HIS; gain; differential-feed

---

### **1. Introduction**

In wireless telecommunication, antenna is used for transmitting and receiving signal. Microstrip antenna is widely used due to its compact size and easy to be implemented in many devices. Surface wave is one problem in microstrip antenna that can reduce the efficiency and gain significantly. This problem can be mitigated by using high impedance surface (HIS) within specific frequency band which is often named as band gap of surfaces wave. Its main functions are the ability to suppress surfaces wave and provide in-phase reflection. Some research has implemented the function of surfaces wave band gap by using various type of unit cell. At 2.4 GHz, the mushroom type increases gain by 1.11 dB, slotted type increases gain by 1.39 dB, and spiral type

increases gain 1.37 dB. In other research, planar rectangular type unit cell which eliminate usage of vias can enhance gain of 2.1 dB at resonant frequency of 10 GHz.

Another development in telecommunication is differential circuit silicon MMIC. Unfortunately most of conventional antennas are single-ended and need balun to interconnect between them, this makes the circuit bulky. Differential-fed antennas can be used to eliminate usage of the balun. In addition, research shows that by integrating differential feed antenna to rectifier as rectenna, it can reach maximum efficiency of 73,9% which is more than 1.5 times higher than rectenna which used only one driven port.

In this paper, a planar unit cell as HIS substrate is implemented to a conventional circular patch microstrip antenna at ISM 2.4 GHz with differential-fed for radiation properties enhancement. Both radiation properties of the conventional and antenna with HIS are compared.

## 2. Antenna Design

Before designing the antenna with HIS unit cell, a conventional antenna has been designed as shown in Fig.1. The antenna consists of 2 layer substrates and 2 differential feeding lines which uses electromagnetic coupled technique. Fig. 1 shows configuration of conventional antenna. The first substrate layer consists of two feeding lines which is the differential-fed and the second layer consist of the circular patch as depicted. This antenna is design to work at ISM 2.4 GHz frequency. Substrate used is Taconic TLY-5 with  $\epsilon_r = 2.2$  and thickness 1.52 mm. The antenna design was conducted using CST Microwave Studio.

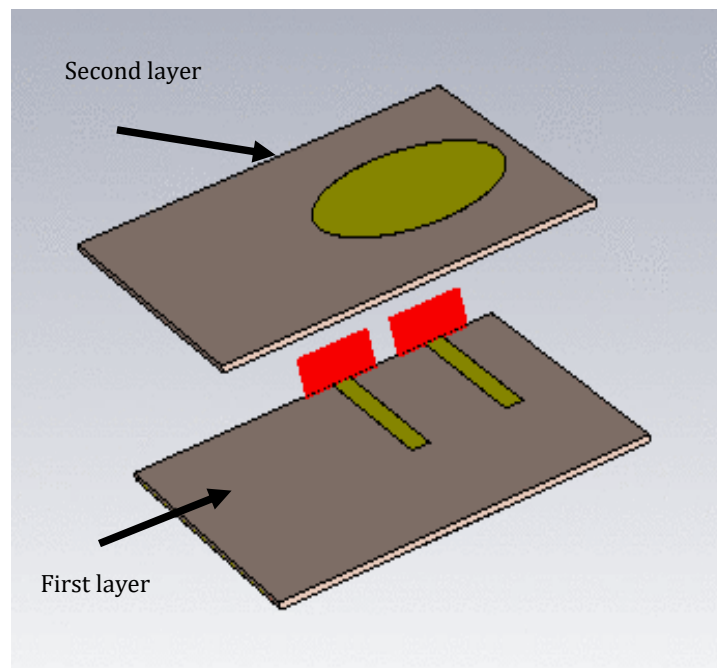

Figure 1. Configuration of conventional antenna.

Next, the High impedance surface unit cell has been designed to enhance antenna gain performance. The proposed HIS unit cell is a planar rectangular patch as shown in

Fig. 2. Reflection phase has been simulated and investigated. At 2.445 GHz, the reflection phase as shown in Fig. 3. is 12 degree. It means at 2.445 GHz, the unit cell has high impedance characteristic because this is in the  $\pm\pi/2$  band which is high impedance surface bandwidth and also works as forbidden band gap for surface waves propagation.

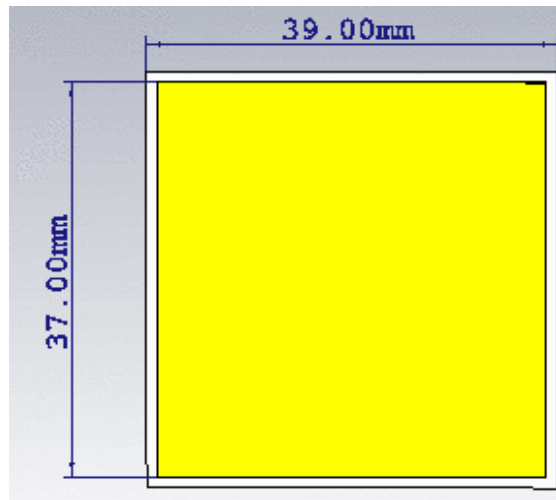

Figure 2. Unit cell structure dimension.

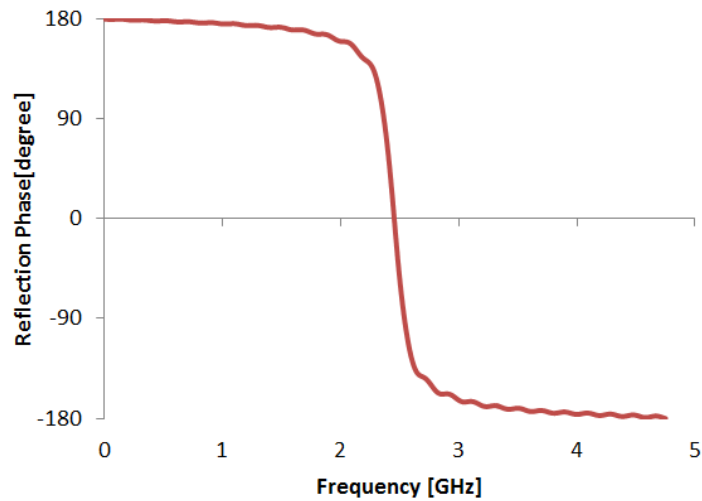

Figure 3. Reflection phase simulation result of the unit cell.

This unit cell is implemented on the bottom substrate layer subtract of the conventional antenna which is designed with two unit cells as shown in Fig. 4. The second substrate layer remains the same with radius of circular patch is 22.66 mm.

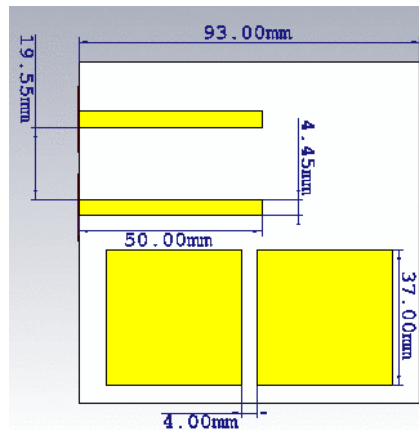

Figure 4. Bottom layer substrate configuration with 2 unit cell.

### 3. Result and Discussion

The antenna with HIS was fabricated and measured and shown in Fig. 5. The comparison between simulation and measurement results are presented in Table 1.

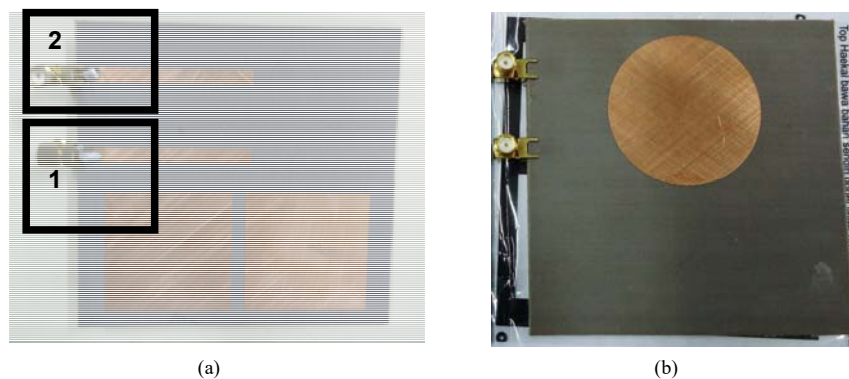

Figure 5. Fabricated antenna top view of (a) first layer (b) second layer.

Table 1. Result comparison

Parameter	Simulation Antenna without HIS	Simulation Antenna with HIS	Measurement Antenna with HIS
S11 (dB)	-26.6	-21.674	-21.97
S22 (dB)	-22.55	-21.9	-18.19
S11 BW (GHz)	2.39 – 2.5	2.38 – 2.53	2.39 – 2.57
S22 BW (GHz)	2.39 – 2.49	2.38 – 2.54	2.40-2.57
Gain port 1	6.01 dB	7.85 dB	7,92 dB
Gain port 2	6.06 dB	7,98 dB	7,12 dB
Input Imp. ( $\Omega$ )	124.08 – 74.6 i	104.89 – 97.46 i	31,83 - 66,53i
Rad. Eff port 1	82.23%	96.55%	n/a
Rad.Eff port 2	80.07%	95.95%	n/a

From Table 1, simulation result of antenna with HIS can be compared to simulation result conventional antenna. Simulation result of antenna with HIS obtained at port 1 shows the impedance bandwidth (S11BW) is increased to 40 MHz and gain increases 1.83 dB compared to conventional antenna. Meanwhile at port 2 the S22 BW increased 60 MHz with gain of 1.97 dB higher than conventional antenna result. Therefore, from the simulation result, the antenna with HIS substrate has larger

bandwidth, improved gain, and also increased radiation efficiency 14.32% for port 1 and 15,88% for port 2. The HIS antenna also improves the input impedance to its reference impedance. The reference impedance for differential-fed antenna is twice of the single ended antenna impedance which is  $100 \Omega$ .

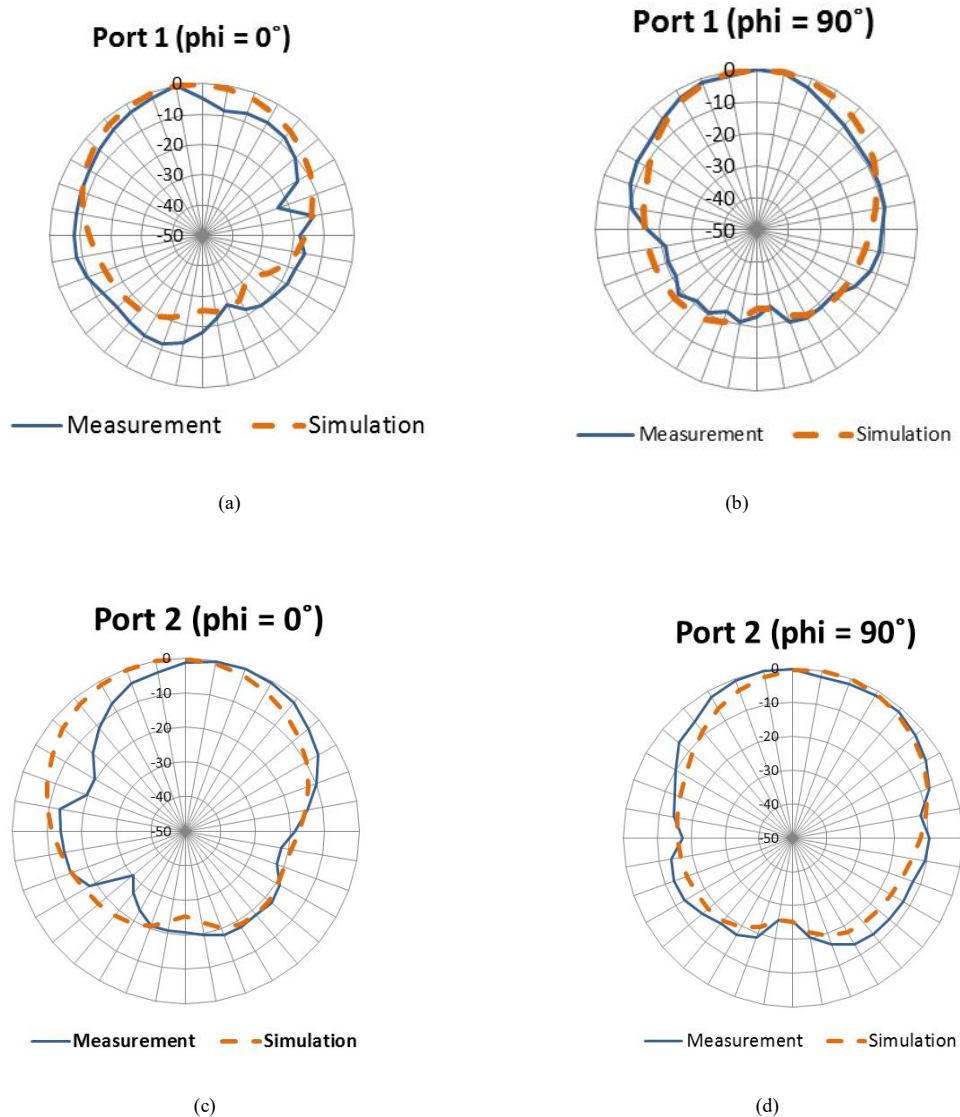

Fig. 6. Radiation Pattern for (a) port 1  $\phi=0$ , (b) port 1  $\phi=90$ , (c) port 2  $\phi=0$ , (d) port 2  $\phi=90$

Antenna with HIS substrate has been fabricated and measured to validate the simulation result of the antenna with HIS substrate. Antenna measurement has been conducted in anechoic chamber, Telecommunication Laboratory, Department of Electrical Engineering, Universitas Indonesia. Table 1 shows similarity between measurement result and simulation result. Another result showed in Fig 6 which shows radiation pattern comparison between measurement and simulation result. Both result and ports show directional radiation pattern.

The slight differences between measurement and simulation result is due to imperfect fabrication process which affects the input impedance.

## 4. Conclusion

This paper presents a high impedance surface substrate implemented on a differential-fed circular patch microstrip antenna. Antenna with HIS substrate has been fabricated and measured to validate the simulation result. Measurement result shows larger bandwidth and increased gain compared to simulation result of conventional antenna. Gain antenna shows 1.91 dB enhancements for port 1 and 1.06 dB for port 2. Directional radiation pattern has been proved by measurement result. HIS also increases the radiation efficiency of 14.32% for port 1 and 15.88% for port 2.

## Acknowledgements

This work was partly supported by “Penelitian Unggulan Perguruan Tinggi” from the Ministry of Research Technology and Higher Education Republic of Indonesia.

## References

- A. Kumar, J. Mohan, and H. Gupta, “Surface wave suppression of micrpstrip antenna using different EBG designs,” International Conference Signal Processing and Communication, 2015, Noida, pp. 355-359.
- D. Sievenpiper, Z. Lijun, R.F.J. Broas, N. G. Alexapoulus, and E. Yablonovitch, “High-impedance electromagnetic surfaces with a forbidden frequency band”, IEEE Transactions on Microwave Theory and Techniques, vol. 47, pp.20159-2074, 1999.
- F. Faishal, A. Ahmad, U. Ali, S. Ullah,”Performance Analysis of a 2,4 GHz Plannar Antenna using Different Type of Wearable Artificial Ground Planes”, 2015 12th Int. Conf. on High-Capacity Optical Networks and Enabling/Emerging Technologies, Islamabad, Dec 21-23, pp.1-5
- G Z. Tong, A. Stelzer, and W. Menzel, “Improved Expressions for Calculating the Impedance of Differential Feed Rectangular Microstrip Patch Antennas,” IEEE Microwave and Wireless Componets Letters, 2012, pp. 441-443
- H. Sun, “An Enhanced Rectenna Using Differentially-Fed Rectifier for Wireless Power Transmission”, IEEE Antennas and Wireless Propagation Letters,2016, Vol.15, pp. 32-35.A
- P. Kovacs, T. Urbanec,”EBG Structures: Practical Tips and Advice for Antenna Engineers”
- Z. Tong, A. Stelzer, C. Wagner, R. Feger, and E. Kolmhofer,”A novel differential microstrip patch antenna and array at 79 GHz,” Available on:  
[ap-s.ei.tuat.ac.jp/isapx/2008/pdf/1645129.pdf](http://ap-s.ei.tuat.ac.jp/isapx/2008/pdf/1645129.pdf)



---

## **MIMO Antenna System for Microsatellite Communications**

Evizal Abdul Kadir<sup>a\*</sup>, Detri Karya<sup>b</sup>, Josaphat Tetuko Sri Sumantyo<sup>c</sup>,  
Husnul Kausarian<sup>d</sup>

<sup>a\*d</sup>*Faculty of Engineering, Islamic University of Riau, Pekanbaru 82824, Indonesia*

<sup>b</sup>*Faculty of Economic, Islamic University of Riau, Pekanbaru 82824, Indonesia*

<sup>c</sup>*Centre of Remote Sensing, Chiba University, Chiba 263-8522, Japan*

---

### **Abstract**

A MIMO antenna system is proposed to improve data throughput limitations in multiple input multiple output for microsatellite and wireless communication systems in this investigation. The 4×4 MIMO antenna is designed to operate in the 2.4 and 2.6 GHz for Microsatellite Communication and Long Term Evolution (LTE) applications. The system's radiation pattern re-configurability is realized by using the microcontroller-driven PIN diode switching concept. Simulations and measurements exhibited good agreements for both of configuration on the 2×2 MIMO and 4×4 MIMO. The antenna is operational between 2.387 to 2.628 GHz, while the simulated and measured reflection coefficients are at least -24.3 dB. All configurations produced a narrow beam forward radiation pattern and suitable for microsatellite communication as well as LTE communication.

### **Keywords**

Antennas, Multiple-Input-Multiple-Output (MIMO), Microsatellite Communication, Long Term Evolution (LTE)

---

## **1. Introduction**

Implementing reconfigurable antenna system onto wireless communication front end has significantly contributed to the improvement of wireless communication systems (WCS). Frequency, polarization, radiation pattern or their combination can be diversified to enable better WCS service delivery. Signal strength and data throughput of WCS can further be enhanced by implementing a reconfigurable system using multiple-input multiple-output (MIMO) antenna for WCS front end in such a way that antennas radiation characteristics are dynamically changed in accordance with the user's behavior such as mobility, data usage and method used to access the WCS. Hence, the introduction of the MIMO antenna system based reconfigurable front end will significantly improve the data capacity and directivity of WCSs. Researches on MIMO antenna based on frequency configurability for mobile devices are investigated in (Haitao, 2013), (Kulkarni, 2013), (Jin, 2012), (Karimian, 2012). Previous research is done on frequency re-configurability to control or steer radiation patterns for MIMO antenna designed, furthermore in these proposed frequency configurable antenna designed is mostly to switch the antenna beam. MIMO antennas which are

---

\* Corresponding author. Tel.: +0-000-000-0000 ; fax: +0-000-000-0000 .  
E-mail address: evizal@eng.uir.ac.id

reconfigurable in terms of polarization and radiation are proposed in (Pei-Yuan, 2012), (Zhengyi, 2009), (Sarrazin, 2009), (Yan, 2013) is based on antenna design such as used slot, array antenna design or butler matrix to control radiation pattern and polarization. In these designs, it is only the receiver side that controls the radiation pattern of the antenna beam. The use of dielectric resonators as MIMO antennas for LTE band is presented in (Cui, 2011). However, the design covers single frequency band at 700 MHz. A compact, ultra wideband MIMO antenna for mobile device proposed in (Jae-Min, 2005). The design is achieved using a printed folded monopole antenna coupled with a parasitic inverted-L element. However, similar to the previous only for receiver side for devices, although cover wideband frequency but not in 2.6 GHz spectrum.

## 2. Reconfigurable MIMO Antenna Design

In this proposed design, individual antennas are cascaded to form the MIMO antenna system. The antenna is implemented using a low-cost FR-4 board with a relative permittivity of  $\epsilon_r = 4.7$ , height,  $h = 1.6$  mm and loss tangent,  $\tan \delta = 0.019$ . The single element and 2x2 MIMO antenna is designed based on the procedure described in (Balanis, 2005), (Evizal, 2014) resulting in optimized structure illustrated in Figure 1. The 2x2 array yielded a narrowband, directional antenna with high gain, and hence, slots are introduced onto the antenna to widen its 10 dB impedance bandwidth.

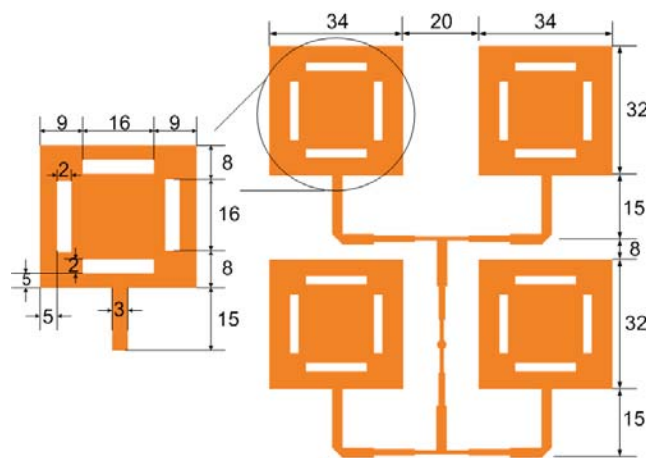

Figure 1. Design of the single MIMO antenna (all dimensions in mm)

The antenna elements are arranged and fed using a corporate feeding scheme. PIN diodes are used to connect the desired antenna feed to the main transmission line as shown in Figure 2, every set element of MIMO antenna has transmission line to connect or disconnect to others element in order to making array element. The locations of the radiating elements (labelled as element 1, 2, 3 and 4) and diodes on the top layer is shown in Figure 2(a), while the bottom layer antenna layer comprising transmission lines is shown in Figure 2(b). A total of 6 PIN diodes are used to connect/disconnect these lines by activating/deactivating the DC power towards each PIN diode using a microcontroller unit.

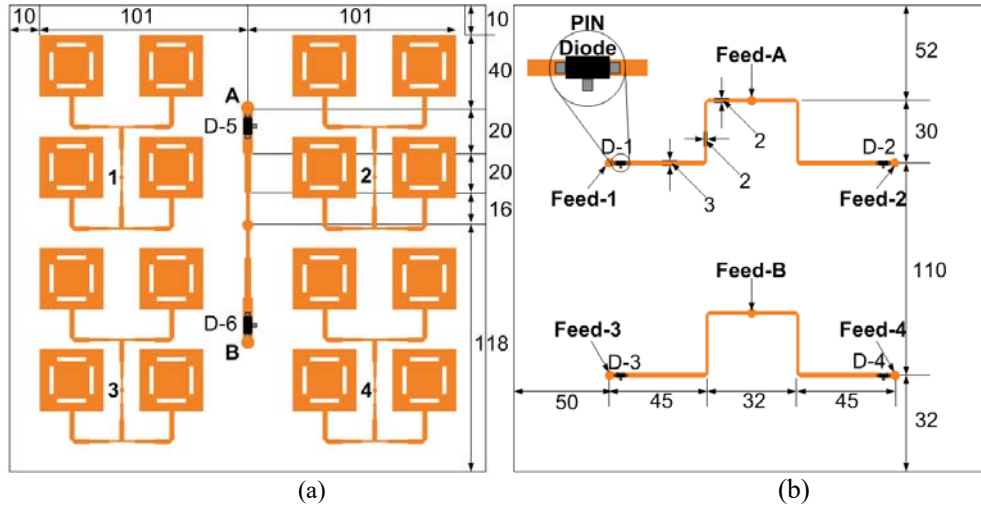

Figure 2. Design of the 4x4 MIMO antenna (a) top view (b) bottom view.

This antenna can be switched using the PIN diode configurations listed in Table 1 to operate between three configurations:

- i. Single (aggregate) mode: all elements of the antenna are set to operate as a single 4x4 array with high gain. The two 2x2 arrays are connected using a single feed centered on top of the substrate. For this configuration, all six PIN diodes are activated.
- ii. Two 2x2 MIMO: Antennas 1 and 2 are connected to a transmission line to form array A. Similarly, antennas 3 and 4 are connected to the transmission line to form array B. The combination of arrays A and B produces the 2x2 MIMO antenna configuration. PIN diodes D-1 and D-2 are activated to feed power into Port A, while diodes D-3 and D-4 are activated to feed power into Port B.
- iii. A 4x4 MIMO: In order to configure antenna become 4x4 MIMO with low gain because every set of MIMO antenna are working independently then antenna ports 1, 2, 3 and 4 are activated simultaneously. This configuration occurs when all the PIN diode is deactivating.

Table 1. PIN diode settings for the three antenna configurations.

CONFIGURATION	DIODE					
	D-1	D-2	D-3	D-4	D-5	D-6
MIMO 4x4	Off	Off	Off	Off	Off	Off
MIMO 2x2	On	On	On	On	Off	Off
Single Antenna	On	On	On	On	On	On

### 3. Antenna Performance Evaluation

The MIMO antenna system is fabricated and integrated with a microcontroller unit to enable its reconfigurable feature. Its prototype is shown in Figure 3. The antenna performance is first evaluated using a vector network analyzer and radiation pattern measurement system in an anechoic chamber. Experimental evaluation of the overall system is then performed in the Wireless Communication Centre (WCC) UTM, to validate its accuracy and limitation.

### 3.1 Evaluation of the MIMO Antenna

To properly evaluate the antenna reflection coefficient, radiation pattern and antenna gain, each ports are evaluated individually while the rest are terminated. Since there are four single antennas, the reflection coefficient for each port is labelled  $S_{11}$ ,  $S_{22}$ ,  $S_{33}$  and  $S_{44}$ . The isolations between the antenna ports are denoted as  $S_{mn}$ . Meanwhile, the ports for the 2x2 MIMO are indicated as ports A and B. Their reflection coefficients are designated as SAA and SAB, while the isolations between ports are labelled as SAB and SBA. Port A is measured when only diodes D-1 and D-2 are activated, while port B when D-3 and D-4 are activated.

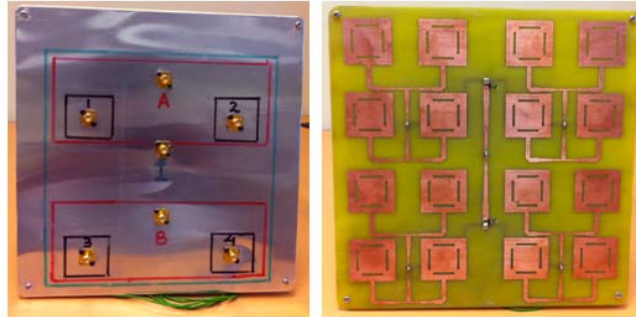

Figure 3. The prototype of the MIMO antenna system top and bottom views.

### 3.2 Testing

The proposed MIMO system is then implemented as an access point for Wireless Local Area Network (WLAN). User types (whether it is a laptop, smart phone, etc) accessing the internet is determined before their data throughput and radio unit is assessed. The use of the WLAN architecture in this section simplifies the assessment procedure due to its availability compared to when LTE devices are used. Figure 4 shows the WLAN access point using the developed MIMO antenna system, consisting of 3 set of Mikrotik R52 radio units and Mikrotik Router Board 133. A microcontroller model Microchip PIC16F877 is used to control the activation of PIN diodes for the MIMO system. The seven MIMO antenna ports are connected to the radio unit via coaxial cables and standard SMA connector.

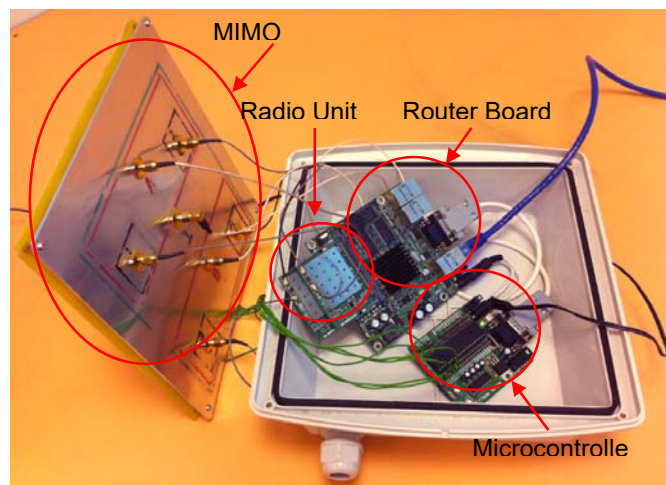

Figure 4. Configuration of MIMO antenna system in the WLAN access point.

#### 4. Results and Discussion

The single MIMO antenna evaluated indicated a satisfactory agreement between simulation and measurement. Its measured reflection coefficient indicated operation from 2.387 to 2.628 GHz for WLAN and LTE bands see Figure 5. Simulations produced a minimum S11 of -27.8 dB at 2.45 GHz whereas the optimal measured S11 of -24.3 dB at a slightly higher frequency of 2.5 GHz.

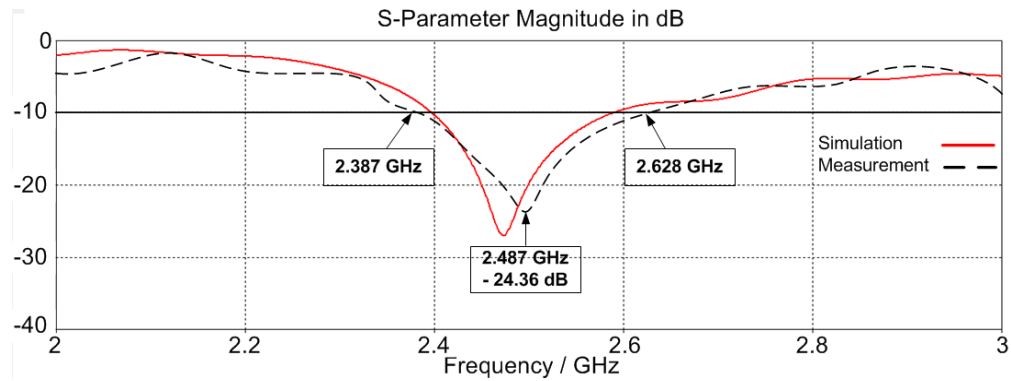

Figure 5. Simulated and measured reflection coefficient of the single MIMO antenna.

Isolation between the antenna ports for this antenna is also assessed and summarized in Figure 6, indicating the maximum isolation of at least 15 dB.

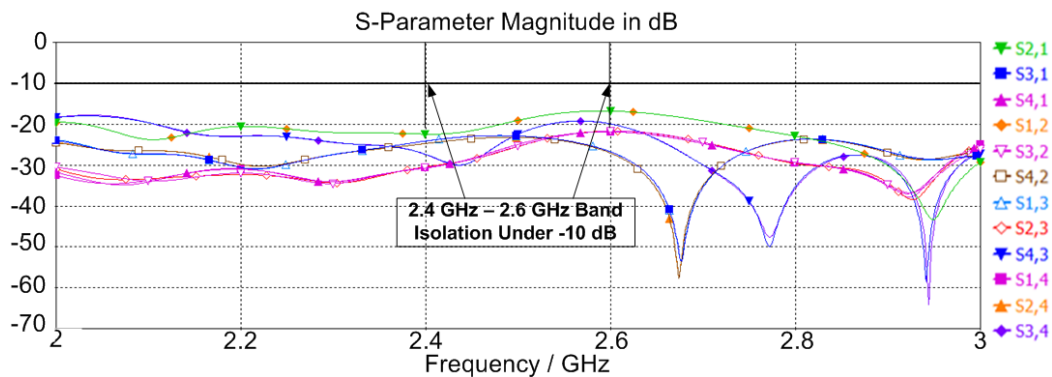

Figure 6. Isolation between different ports of the MIMO antenna.

The radiation pattern of the first configuration, the 4×4 MIMO antenna are simulated and measured at 2.5 GHz, as shown in Figure 7 indicating a good agreement. A directional forward beam is generated for the E- and H-planes with minimal side lobes.

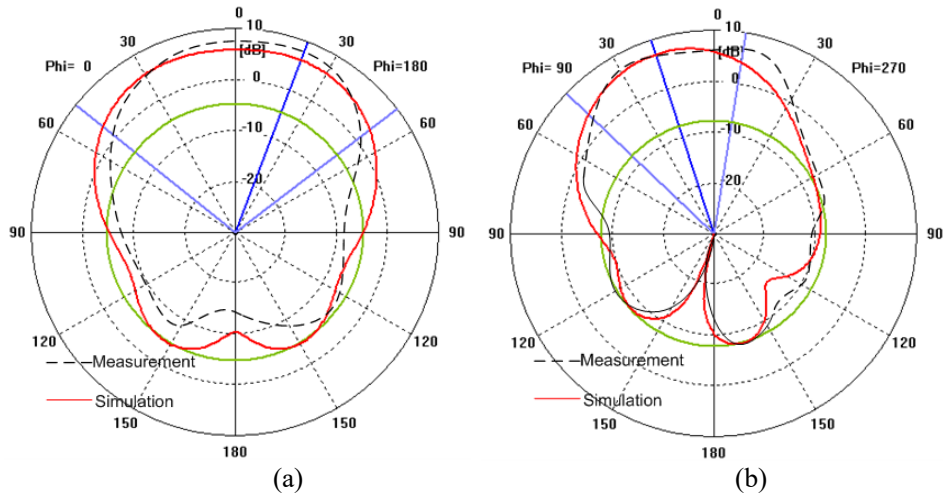

Figure 7. Radiation pattern of a single antenna (a) E-field (b) H-field.

Next, the 2x2 MIMO antennas are evaluated by activating PIN diodes 1, 2, 3 and 4. MIMO antennas 1 and 2 connected to Port A, and 3 and 4 connected to Port B are also evaluated separately in terms of reflection coefficient and inter-port isolation, see Figure 8. Isolation between ports A and B are at least 10 dB.

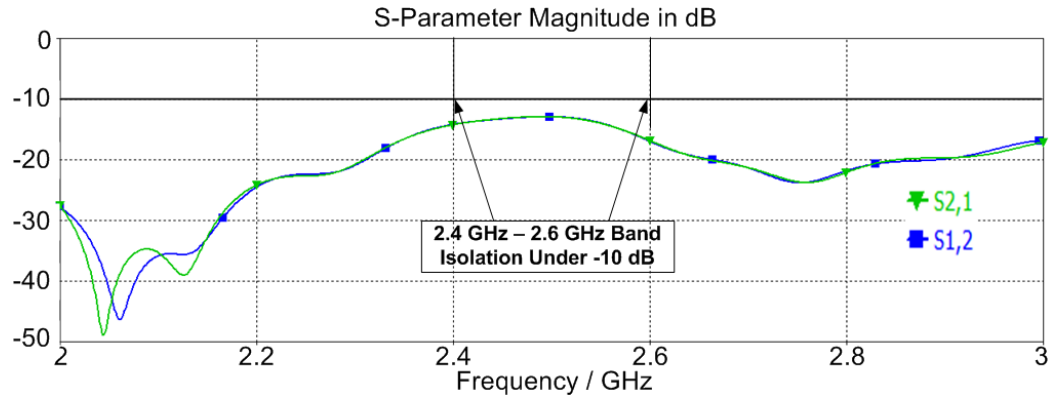

Figure 8. Inter-port isolation of the 2x2MIMO antenna.

Similar to the previous structure, the radiation pattern of 2x2 MIMO are performed separately at 2.5 GHz and summarized in Figure 9. Note that the same forward radiation is exhibited with a narrower beamwidth compared to the previous single antenna due to the additional array elements. Simulated and measured results agreed with slight minor lobe disagreements.

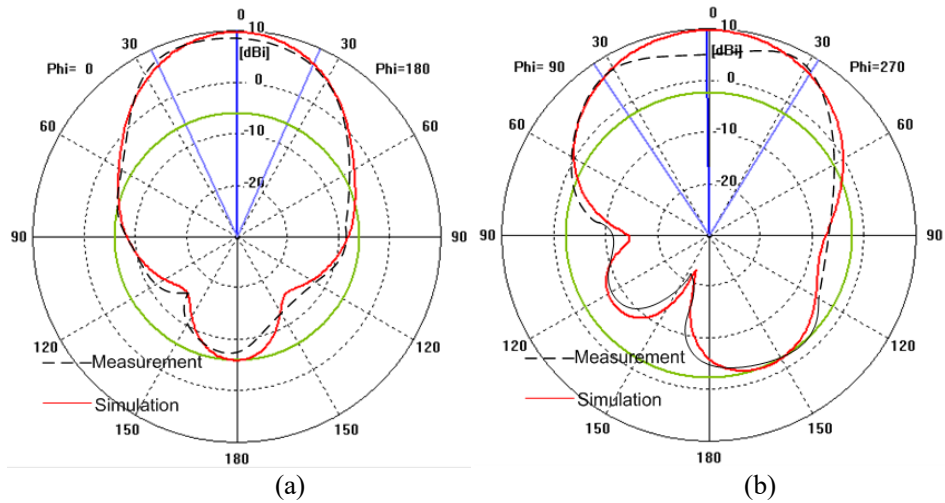

Figure 9. Radiation pattern of dual MIMO antenna (a) E-field (b) H-field.

The third antenna operation as a single, high gain 4x4 array is evaluated by activating all PIN diodes to enable each element's connection to the transmission line.. Its radiation pattern is measured at 2.5 GHz, similar to previous evaluations, and shown in Figure 10. Notice that the beam direction is narrower compared to the previous single and dual MIMO antenna.

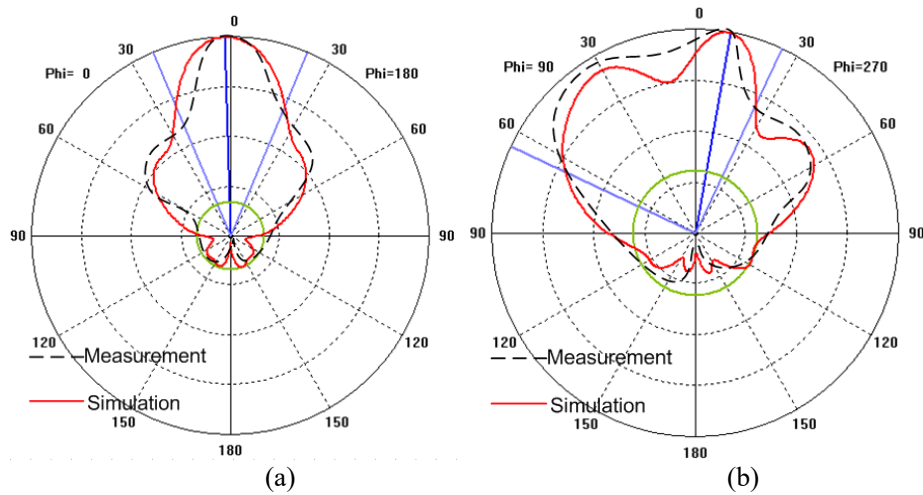

Figure 10. Radiation pattern of single MIMO antenna (a) E-field (b) H-field

## 5. Conclusion

A reconfigurable MIMO antenna system for WLAN and LTE standards has been proposed, consisting of rectangular slotted microstrip antenna elements. They form an array antenna which can either be configured as a 2x2 or 4x4 MIMO antenna system, or can also be used as a conventional high gain directional array. Pattern configurability is achieved via the switching of six PIN diodes located on the microstrip transmission line. Measurements confirmed that the antenna is operational from 2.387 to 2.628 GHz, agreeing well with simulations with optimal reflection coefficients of -27.8 dB at 2.4 GHz and -24.3 dB at 2.6 GHz, respectively. The proposed system is then integrated within a WLAN access point and further evaluated in a practical environment. Both 2x2 and 4x4

MIMO antenna configurations produced narrow beam forward radiation patterns in both E- and H-planes, and met the ECC requirement of below 0.5 and diversity gain of between 9 and 10 dBi.

## References

- Haitao, L. (2013), "Compact MIMO Antenna With Frequency Reconfigurability and Adaptive Radiation Patterns," *Antennas and Wireless Propagation Letters, IEEE*, vol. 12, pp. 269-272.
- Kulkarni, A.N. and Sharma, S.K. (2013), "Frequency Reconfigurable Microstrip Loop Antenna Covering LTE Bands With MIMO Implementation and Wideband Microstrip Slot Antenna all for Portable Wireless DTV Media Player," *Antennas and Propagation, IEEE Transactions on*, vol. 61, pp. 964-968.
- Jin, Z.J. (2012), "Frequency reconfigurable multiple-input multiple-output antenna with high isolation," *Microwaves, Antennas & Propagation, IET*, vol. 6, pp. 1095-1101.
- Karimian, H.R. (2012), "Tri-band four elements MIMO antenna system for WLAN and WiMAX application," *Journal of Electromagnetic Waves and Applications*, vol. 26, pp. 2348-2357.
- Pei-Yuan, Q. (2012), "A Pattern Reconfigurable U-Slot Antenna and Its Applications in MIMO Systems," *Antennas and Propagation, IEEE Transactions on*, vol. 60, pp. 516-528.
- Zhengyi, L. (2009), "Compact Reconfigurable Antenna Array for Adaptive MIMO Systems," *Antennas and Wireless Propagation Letters, IEEE*, vol. 8, pp. 1317-1320.
- Sarrazin, J. (2009), "Pattern Reconfigurable Cubic Antenna," *Antennas and Propagation, IEEE Transactions on*, vol. 57, pp. 310-317.
- Yan, J.B. and Bernhard, J.T. (2013), "Implementation of a Frequency-Agile MIMO Dielectric Resonator Antenna," *Antennas and Propagation, IEEE Transactions on*, vol. 61, pp. 3434-3441.
- Sharawi, S. and Aloji, D.N. (2013) "Isolation improvement in a dual-band dual-element MIMO antenna system using capacitively loaded loops," *Progress In Electromagnetics Research*, vol. Vol. 134, pp. 247-266.
- Wi, W. Jung, and Lee, B. (2013), "Wultiband handset antenna analysis including lte band MIMO service," *Progress In Electromagnetics Research*, vol. Vol.138, pp. 661-673.
- Cui, L.S., Jiang, W., Gong, S.X., Guan, Y. and Yu, S.T. (2011), "A Novel Compact Dual-Band MIMO Antenna with High Port Isolation," *Journal of Electromagnetic Waves and Applications*, vol. 25, pp. 1645-1655.
- Jae-Min, L. (2011), "A Compact Ultrawideband MIMO Antenna With WLAN Band-Rejected Operation for Mobile Devices," *Antennas and Wireless Propagation Letters, IEEE*, vol. 11, pp. 990-993.
- Balanis, C.A. (2005), *"Antenna Theory", Analysis and Design*: John Wiley & Sons.
- Evizal, Supriyanto, E., Rahman, T.A., Rahim, S.K.A., and Rosa, L.R. (2014), "Multiple Bands Antenna with Slots for Wireless Communication System," *Advances in Robotics, Mechatronics and Circuits*, pp. 173-177.



---

**DEVELOPMENT L-BAND ANTENA WITH LOW POWER FOR  
CIRCULARLY POLARIZED-SYNTHETIC APERTURE RADAR (CP-  
SAR) APPLICATION ON UNMANNED AERIAL VEHICLE (UAV)**

Muhammad Fauzan Edy Purnomo<sup>a,b</sup>, Rahmadwati<sup>c</sup>, Hadi Suyono<sup>d</sup>, Rudy Yuwono<sup>e</sup>,  
Joshapat Tetuko Sri Sumantyo<sup>f</sup>

<sup>a,c,d,e</sup>*Electrical Engineering Department, Faculty of Engineering, Brawijaya University,  
Malang 65145, Indonesia*

<sup>b</sup>*Electrical Engineering and Computer Science, Kanazawa University, Kakuma-machi,  
Kanazawa, Ishikawa 920-1192, Japan*

<sup>f</sup>*Center for Environmental Remote Sensing (CEReS), Josaphat Microwave Remote Sensing  
Laboratory (JMRS�), Chiba University, Chiba 263-8522, Japan*

---

**Abstract**

The development of radar technology, Synthetic Aperture Radar (SAR) and Unmanned Aerial Vehicle (UAV) relatively fast and demanding needs of communication facilities and infrastructure that has a variety of platforms and imaging of high quality, which can generate data processed with high resolution and a better image for all types of terrain explored. In this paper, it obtain the array construction antenna for Circularly Polarized-Synthetic Aperture Radar (CP-SAR) embedded an UAV with compact, small, and simple configuration i.e. the developing a single and 16-element array antenna with simple equilateral triangular-shaped, tip-truncated patch for CP-SAR operated in the L-band.

An equilateral triangular truncated microstrip antenna is proposed for circularly-polarized synthetic aperture radar (CP-SAR) systems operated in L-Band (1.27 GHz). Electromagnetically coupled, dual-feeding method is applied to generate the circularly polarized wave radiating from the patch. The performance characteristics of these antennas are circular polarization, both circular to the left or to the right, making them easier to capture images of objects on earth for processing information content that can be utilized. The feeding design concept is implemented by simple feed with likely length square-shape that can generates two modes using perturbation segment (*as*) and stimulate the same current distribution at each patch and also excite both a left-hand circular polarization (LHCP) and a right-hand circular polarization (RHCP). The simulated antenna based on the IE3D software using moment method gives a good circular polarization at the center frequency of 1.27 GHz with an impedance bandwidth of 0.5% and 3-dB axial ratio bandwidth of 100%, satisfying the specification for our circularly polarized synthetic aperture radar intended for using on-board an UAV.

**Keywords**

Single and 16-element; Equilateral triangular-shaped; Tip-truncated; Simple feed; Circularly polarized

## 1. Introduction

Synthetic aperture radar (SAR) in the microwave band is active sensors which can produce high-resolution images in the microwave band. The use of microwave frequencies allows penetration through the clouds, and even through the forest canopy for bands of lower frequencies. Conventional SAR systems have been based on a linear polarized (LP) antenna system. A circularly polarized SAR (CP-SAR) which will be launched on-board micro-satellites currently developed in Microwave Remote Sensing Laboratory (MRSL) from the Center for Environmental Remote Sensing (CeRES), Chiba University (Sri SU et al, 2009). As part of this project, the development of CP-SAR air is also conducted to gain enough knowledge about CP-SAR sensor system. L-band CP-SAR system will be designed for operation on-board the unmanned aerial vehicle (UAV). However, there are limitations due to the phenomenon of propagation such as variation within geometrically between the radar system and the Earth, the phase shift when the microwave attack smooth, reflective surfaces, etc. this phenomenon causes the modulation unwanted signal backscatter, redistribution random back signal-energy and in the end, the image formed will face blurring and defocusing spatial variants and unambiguous identification low backscatter different features in a scene (Yohandri et al, 2011). Especially for the propagation space, electromagnetic waves propagate through the ionosphere interact with electrons and magnetic fields.

The full characterization of SAR signals backscattered from random objects can only be made possible through the use of circular polarization. Therefore, compared with the linear SAR sensor, a large amount of information about the scene and the target is imaged will be provided with a CP-SAR sensor (Baharuddin et al, 2009). The results of synthesis of circularly-polarized data are far better compared to those constructed from the conventional linearly-polarized data. In addition, more sensitive measurements may be obtained by using circular polarization when the surface roughness was studied using polarimetric SAR data (Mattia, 1997). This work focuses on the design CPSAR L-band antenna both single element and 16-element array with a new shape i.e. equilateral triangular truncated antenna using proximity fed.

The purpose of the present paper is to describe the development of the LHCP and RHCP single and 16-element array microstrip antenna installed on UAV. In general, a microstrip antenna can attain a narrow frequency bandwidth at the expense of a low gain. As compared with conventional microwave antennas, a microstrip antenna has additional advantages such as a compact size, light weight, conformability to surfaces of substrates, low cost, and easier integration with other circuits and versatility (Garg et al, 2001). For CP-SAR applications, an array configuration must be adopted to satisfy the requirement of the system. Here, we propose an L-band CP-SAR antenna consisting of single and 16-element of simple equilateral triangular truncated microstrip antenna with 1 and 16 feeding.

## 2. Configuration of Array Antenna

The antenna structure of single element (Basari et al, 2006) and sixteenth-element array antenna which carried out the design and modeling are depicted in Figure 1. and Figure 2., respectively. Design and modeling software refers to the antenna IE3D to get the antenna receiving and transmitting placed in the fuselage UAV with working frequency of 1.27 GHz. More complete data for the technical specifications of CP-SAR antenna on a UAV can be seen in Table. 1. The shape of the antenna to be made is the truncated form of an equilateral triangle, made of type NPC (Nippon Pillar Packing)-H220A (Edy PUR and Sri SU, 2011), with a relative permittivity of 2.17, loss tangent of

0.0005, and the substrate thickness of  $1.6 \text{ mm} \times 2$  (patch radiating and feeding) = 3.2 mm.

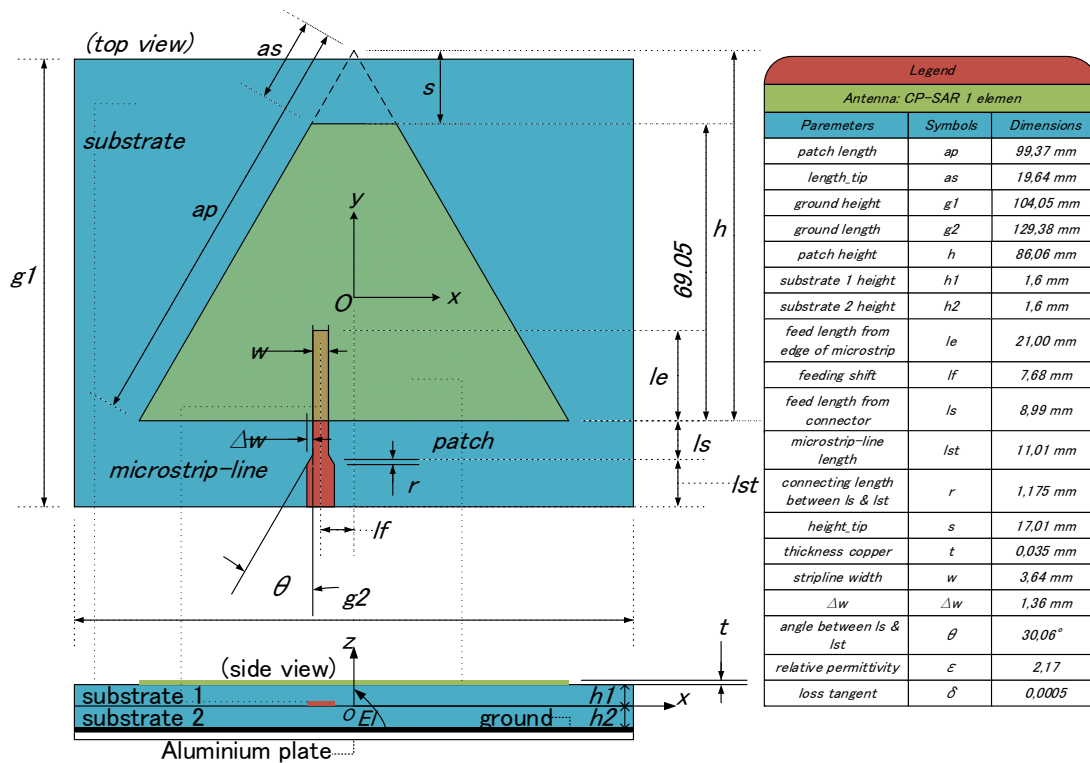

Figure 1. the construction of single element antenna

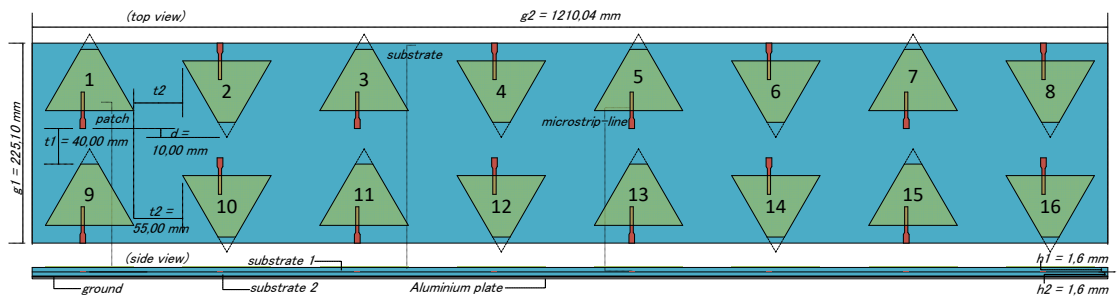

Figure 2. the construction of 16-elements array antenna

While, the truncated function is to make circular polarization both LHCP and RHCP depend on the loci of feeding antenna. Similar with the truncated function, for more stability of it, the proximity technic of fed operated for making smooth circular polarized, to wide bandwidth, increase the gain and also to adjust coupling with the element beside it (Edy PUR et al, 2015). In matter of coupling, the distance between apex of array elements both of beside of it and upper or below of it are set 55 mm and 40 mm, respectively. It is meant to reduce isolation with each closer patch and thus to get sufficient gain for obtaining the minimum requirement 3 dBic for single element. Usually, for decreasing coupling to patch element closer each other, need the distance between the patch element (in this case  $1/3 h$ , where  $h$  is a height of patch antenna) to the other closer patch element ( $t_1 = 47.01 \text{ mm}$  and  $t_2 = 55 \text{ mm}$ ) is based on the formula  $0.5 \lambda < d$

$< \lambda$ , where  $\lambda$  is wavelength of used (Tanaka et al, 2006). Moreover, the size of ground  $g1 = 233.11$  mm and  $g2 = 1209.96$  mm

Table 1. Technical specification of CP-SAR antenna on-board UAV

No	Antenna Parameters	Specification for UAV
1.	Resonance Frequency (Center) (GHz)	1,27
2.	Pulse Band Wide (MHz)	233,31
3.	Axial Ratio (dB)	$\leq 3$
4.	Antenna Efficiency (dBic)	$>80$ %
5.	Gain Antenna (degree)	14,32
6.	Azimuth Beamwidth (degree)	$\geq 6,77^0$
7.	Elevation Beamwidth (degree)	$3,57^0 - 31,02^0$
8.	Antenna Size (m)	1,5 x 0,4
9.	Polarization (Tx/Rx)	RHCP + LHCP

### 3. Results

#### 3.1 Single Antenna

In Figure 3. to Figure 5., the images show the simulation results of antenna gain of LHCP, RHCP and the total gain of a single antenna with a truncated equilateral triangle proximity fed. Gain total shows the stability of the gain because of an accumulation of LHCP and RHCP gain with a value of 4 dBi which is relatively better than the LHCP and RHCP gain at target frequency of 1.27 GHz. A single antenna with a reduction in length-patch (truncated) makes the total vector current distribution is reduced in the truncated area which caused wide-band antenna becomes narrow (Edy PUR et al, 2016).

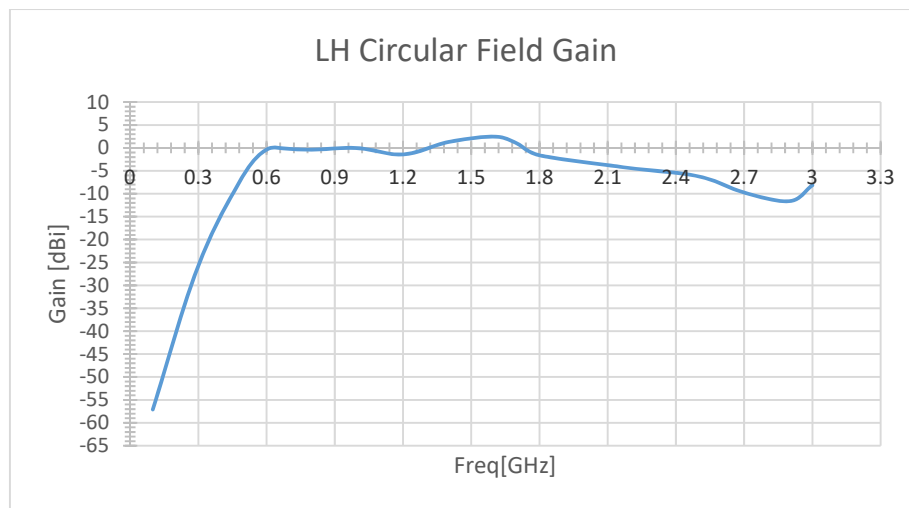

Figure 3. LHCP gain

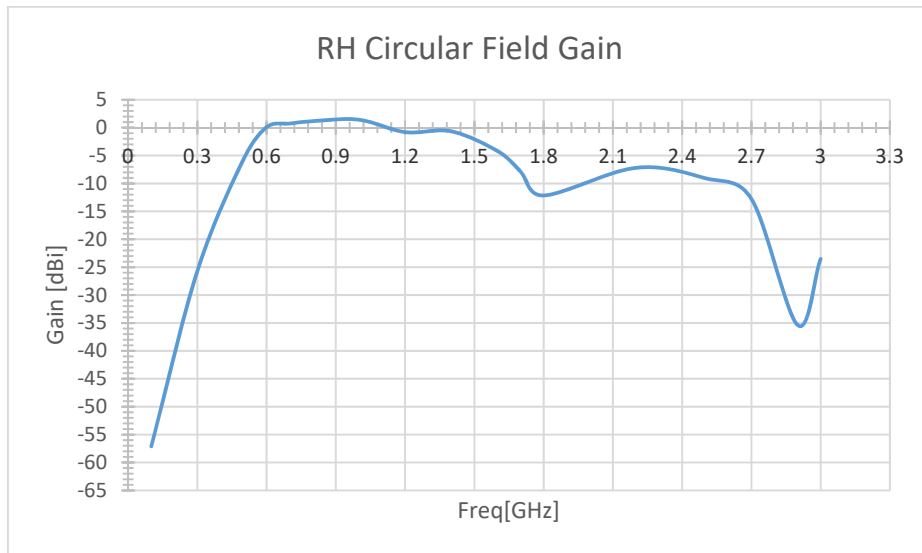

Figure 4. RHCP gain

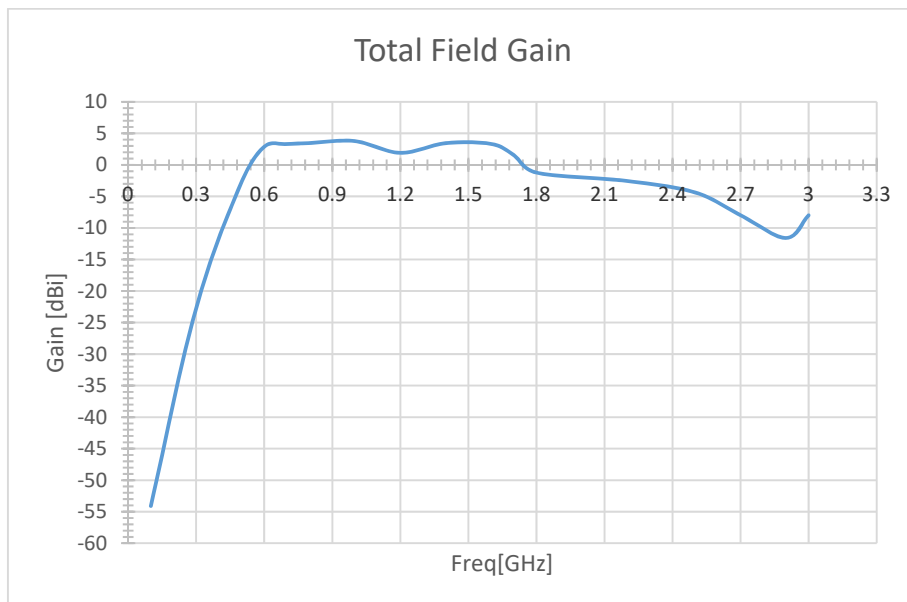

Figure 5. total gain

Figure 6. shows the value of axial ratio ( $Ar$ ) for simulation at the target frequency of 1.27 GHz at 0.0001 dB. In addition,  $Ar$ -3dB bandwidth of the antenna closer to the maximum of 100%.

Figure 7. shows the relationship between the  $S$ -parameters and frequencies for simulation of antenna  $T_x/R_x$ . In this figure, it can be seen that the  $S$ -parameters of an equilateral triangle truncated antenna at the target frequency of 1.27 GHz approximately -12.3 dB.

In the Figure 8. describes the characteristics of the input impedance of the  $T_x/R_x$ . This figure shows that the real part of the simulation has the result of close to 50  $\Omega$ . While the reactance of the equilateral triangle truncated antenna also close to 0  $\Omega$ . Furthermore, the impedance bandwidth (below -10 dB) of the antenna is about 2 MHz.

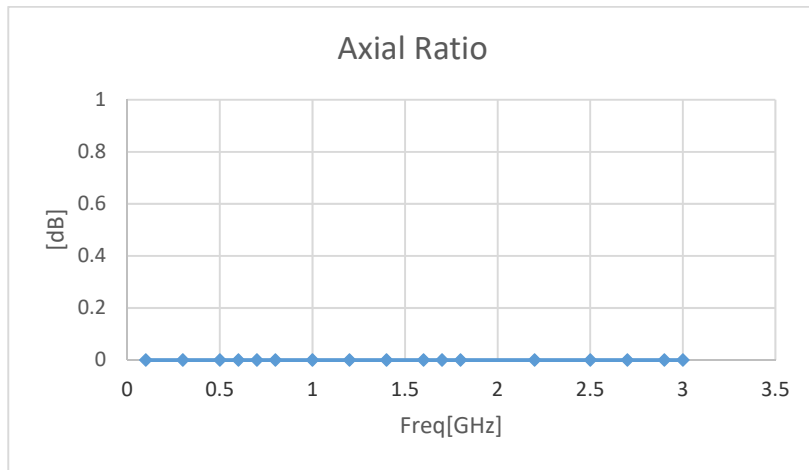

Figure 6. axial ratio

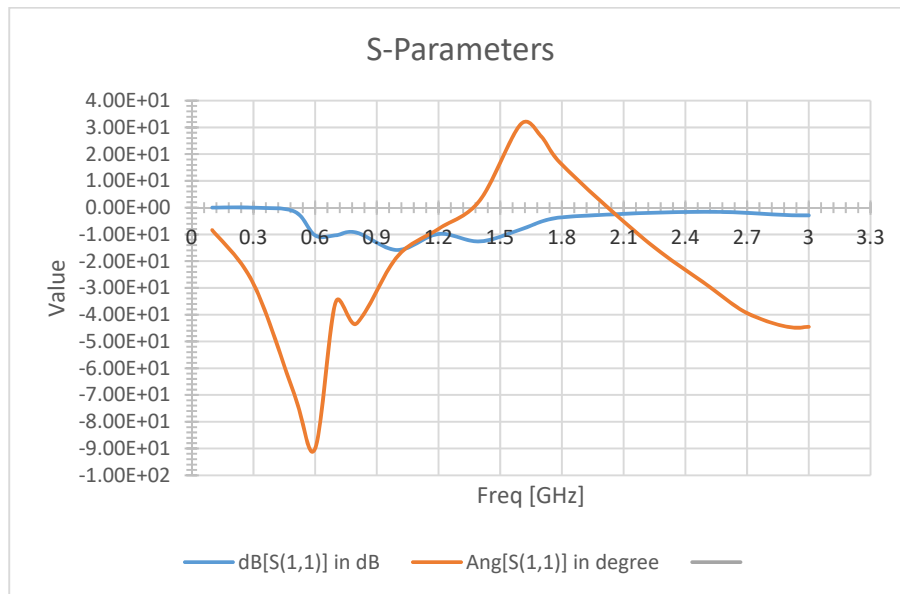

Figure 7.s-parameter

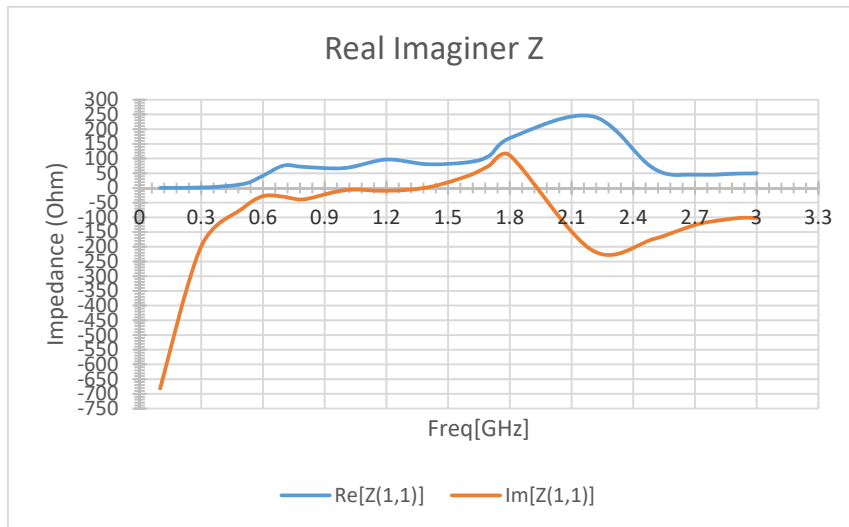

Figure 8.input impedance

Figure 9. and Figure 10. show the efficiency of the antenna and the radiation efficiency in which the radiation efficiency (60%) greater than the antenna efficiency (55%) on a target frequency of 1.27 GHz. This is due to the radiation efficiency parameter depends only on the values of loss while on the efficiency of antenna radiation other than radiation loss is also a loss of materials, dielectric loss and others.

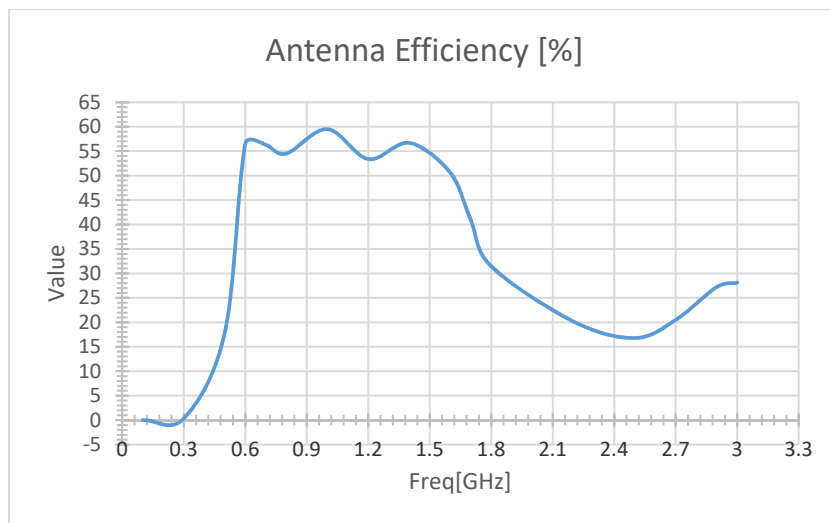

Figure 9. antenna efficiency

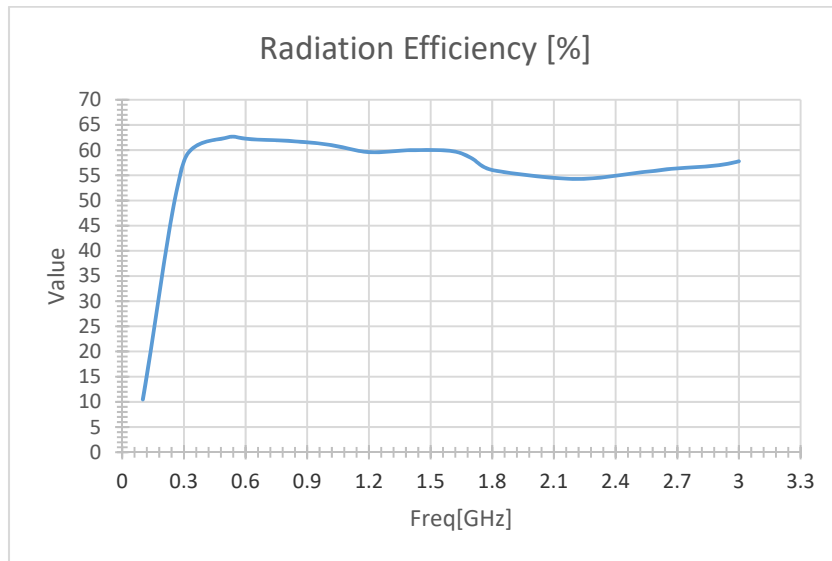

Figure 10. radiation efficiency

### 3.2 Array Antenna

In Figure 11 until Figure 13, the images show the simulation results gain antenna among LHCP, RHCP and the total gain of the 16-element array equilateral triangular truncated antenna which used the proximity fed. Gain total shows the stability in value due to an accumulation of LHCP and RHCP gain accumulation with a value of 12.5 dBi. While the LHCP gain is relative the same with RHCP gain at the target frequency 1.27 GHz about 9.4 dBi. The 16-element array antenna are made by combining several single patch to increase the gain as long as the coupling that occur in each single element is to set a minimum distance between the closed element about  $\frac{1}{4}$  wavelength.

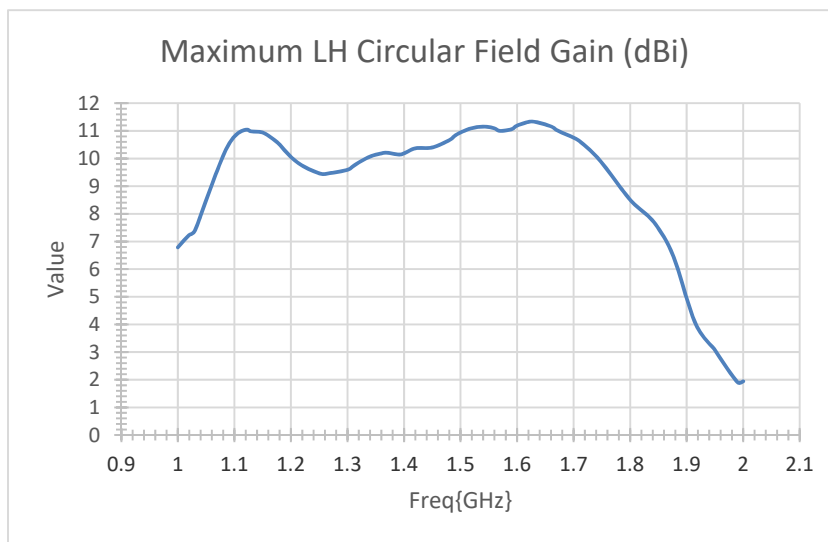

Figure 11. LHCP gain



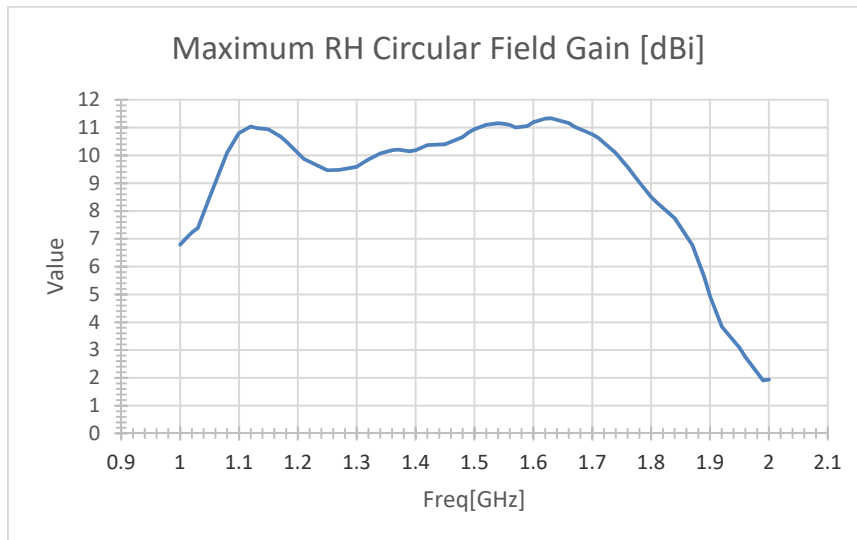

Figure 12. RHCP gain

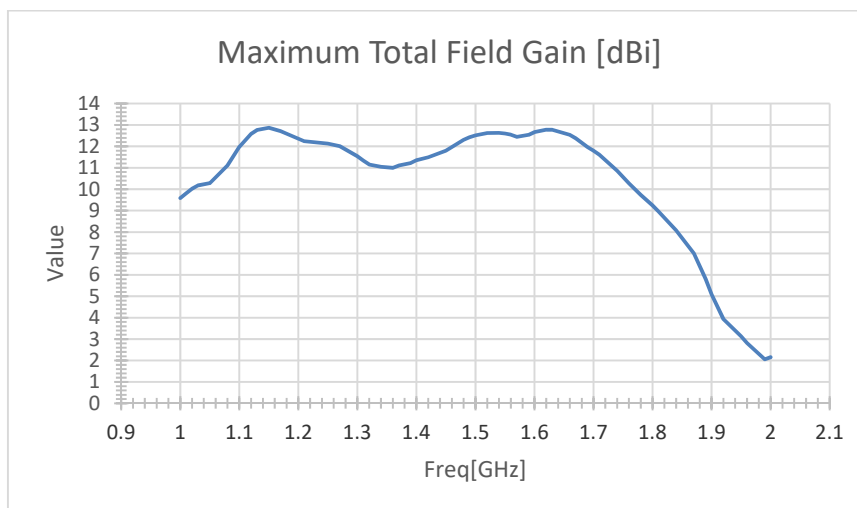

Figure 13. total gain

Figure 14. shows the value of axial ratio ( $Ar$ ) 16-element array antenna that is relatively the same the result of a single antenna for simulation at the target frequency of 1.27 GHz amounted to 0.0001 dB. In addition,  $Ar$ -3dB bandwidth of the antenna approach maximum of 100%.

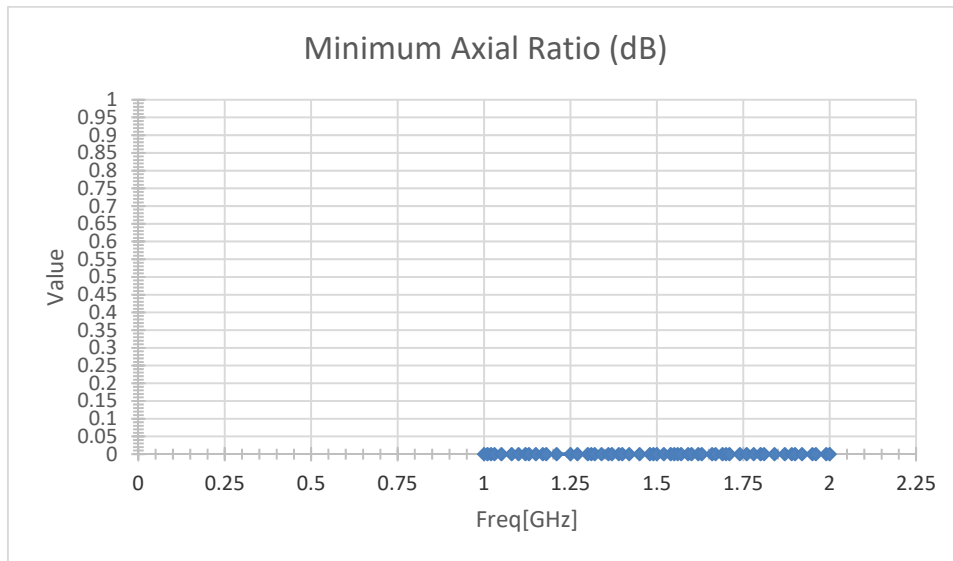

Figure 14. axial ratio

Figure 15 until Figure 18, the figures show the relationship among the S-parameters and frequencies for element S-11 (represented by the elements patch number 5), S-12, S-19, S-910 from the simulated antenna Tx / Rx. On figure, it is seen that the S-12 and S-910 has a relatively similar results for patch elements are located adjacent positions (left-right), but very different from the S-19 because of the position of the patch antenna is top-down. It can be seen that the effect of coupling loss of each patch antenna occurs that the S-19 is relatively better than the S-12 and S-910, each value in the target frequency range of 1.27 GHz about -21.7 dB and -19.5 dB, respectively. While the value of the S-11 is decreased comparing with the single element antenna (-12.3 dB) of approximately -6.7 dB at the target frequency 1.27 GHz. This matter due to the 16-elements array antenna fed using 16 feeding and all of each element are not still matched yet. Hence, it is very important in order to obtain loss minimum possible value and to distribute the flow maximum power and optimum gain, the optimized array antenna design is necessity.

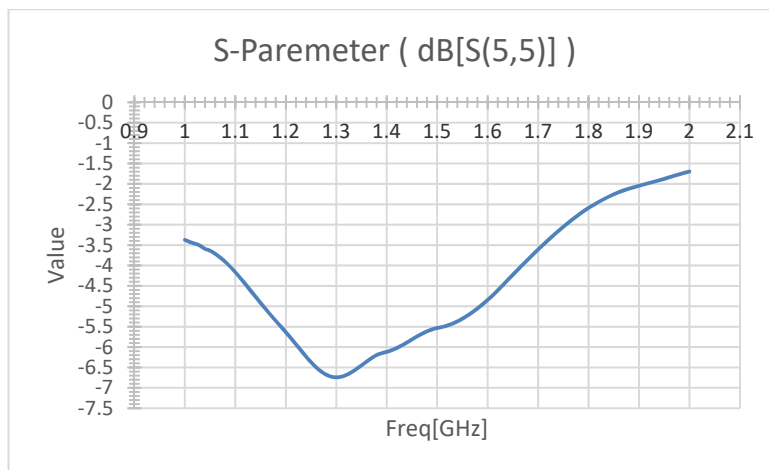

Figure 15. S-11

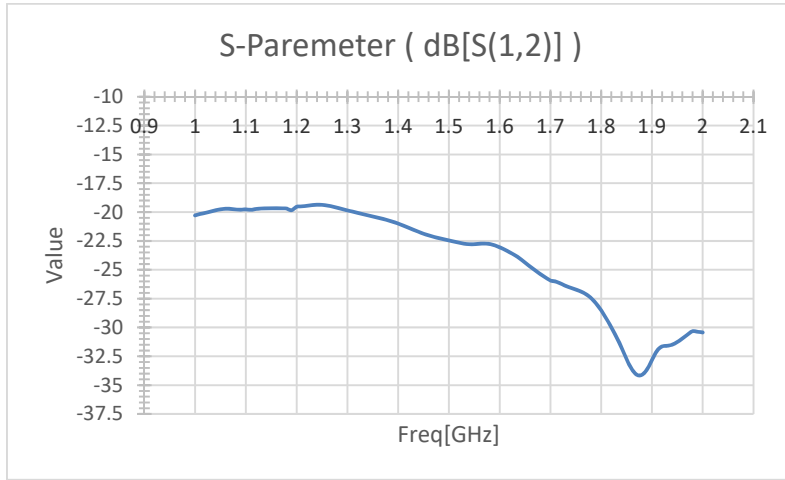

Figure 16. S-12

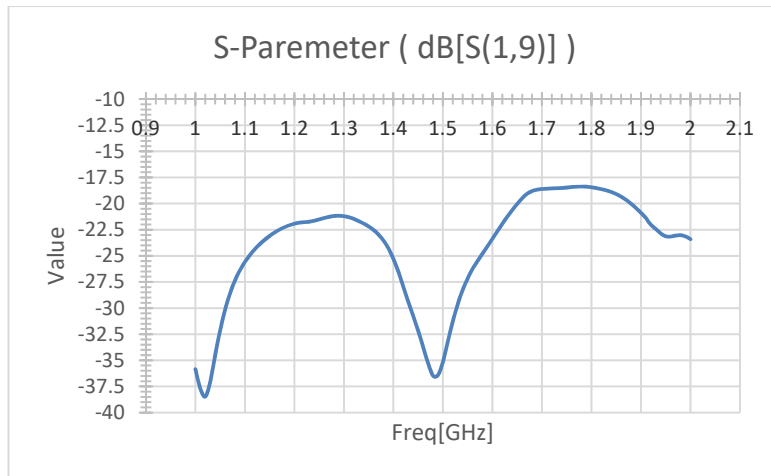

Figure 17. S-19

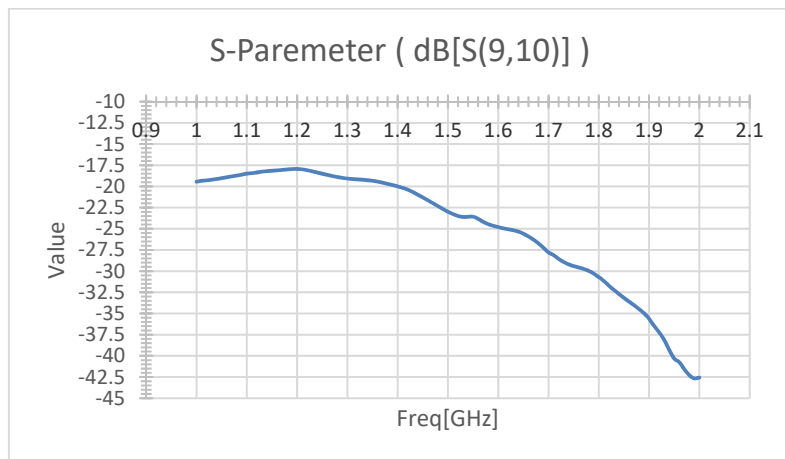

Figure 18. S-910

#### 4. Conclusion

The research process has already discussed to the stage of the single antenna design and array antenna 16-elements of the equilateral triangle truncated with proximity fed, where its performances still need to be optimized especially value the gain and efficiency of the antenna. For the value of  $S$ -parameter of single antenna is good enough because it was below -10 dB, however for the array antenna still need to be optimized because it was still in the upper of -10 dB. While the value of input impedance for the real and the imaginary, especially for a single antenna ranges approaching 50  $\Omega$  and 0  $\Omega$ . The value of the gain of the antenna is increased when compiled 16-elements rather than single element i.e. from the 4 dBi to become 12.5 dBi, while the axial-ratio both single and 16-element array antenna are relatively the same at the target frequency 1.27 GHz approximate 0.0001 dB.

#### Acknowledgements

The authors would like to thank the Microelectronic Research Laboratory (MeRL), Kanazawa University, Japan for the support and the Center for Environmental Remote Sensing (CEReS), Josaphat Microwave Remote Sensing Laboratory (JMRS�), Chiba University, Japan for joint cooperation in this research and also to thank the Ministry of Research, Technology and Higher Education, Indonesia for supporting research through the research grand on the name of BOPTN 2016.

#### References

- Baharuddin, M., Wissan, V., Sri SUMantyo, J.T. and Kuze, H. (2009). Equilateral Triangular Microstrip Antenna for Circularly-Polarized Synthetic Aperture Radar. *Progress in Electromagnetics Research C*, Vol. 8, 107–120.
- Basari, Sri SUMantyo, J.T., Takahashi, M., Ito, K. (2006). Circularly Polarized Triangular Microstrip Array Antenna Using Single-Fed Proximity-Coupled for Mobile Satellite Communications Applications. *Proceeding IJSS 2006*.
- Edy PURnomo, M.F. and Sri SUMantyo, J.T. (2011). Design circularly polarized of equilateral triangular hole antenna for SAR (Synthetic Aperture Radar). *IEICE Technical Report*, ISSN 0913-5685, Vol. 111 No. 239, October 17-19, 2011.
- Edy PURnomo, M.F., Pramono, S.H., Pamungkas, M.A. and Taufik. (2015). Study of the effect of air-gap on array microstrip antenna performances for mobile satellite communications. *ARPN Journal of Engineering and Applied Sciences* ISSN 1819-6608, Vol.10.No.20.
- Edy PURnomo, M.F., Suyono, H., Mudjirahardjo, P. and Hasanah R.N. (2016). Analysis performance of singly-fed circularly polarized microstrip antenna for wireless communication. *Jurnal TEKNOLOGI* e-ISSN 2180-3722, Vol. 78. No. 5-9.
- Garg, R., P. Bhartia, I. Bahl, and A. Ittipiboon. (2001). *Microstrip Antenna Design Handbook*. Artech House, London.
- Mattia, F., Toan T.L., Souyris, J., Carolis, G.D., Floury, N., Posa, F. and Pasquariello, G. (1997). The effect of surface roughness on multifrequency polarimetric SAR data. *IEEE Trans. Geoscience and Remote Sensing*, Vol. 35, No. 4, 954–966.
- Sri SUMantyo, J. T., Wakabayashi, H., Iwasaki, A., Takahashi, F., Ohmae, H., Watanabe, H., Tateishi, R., Nishio, F., Baharuddin, M. and Akbar RIZki, P. (2009). Development of circularly polarized synthetic aperture radar on-board microsatellite. *PIERS Proceedings*, 382–385, Beijing, China, March 23–27, 2009.
- Tanaka, T., Houzen, T., Takahashi, M., and Ito, K. (2006). Circularly Polarized Printed Antenna Combining Slots and Patch. *IEICE Transaction Communications*, VOL.E89—B.
- Yohandri, Wissan, V., Firmansyah, I., Akbar RIZki, P., Sri SUMantyo, J.T. and Kuze, H. (2011). Development of circularly polarized array antenna for synthetic aperture radar sensor installed on UAV. *Progress In Electromagnetics Research C*, Vol. 19, 119-133.

---

## **Ground-based Spectral Measurements of Chlorophyll**

### **Fluorescence from Vegetation Canopies**

Kenji Kuriyama<sup>a</sup>, Koki Homma<sup>b</sup>, Tatsuhiko Shiraiwa<sup>c</sup>,  
Naohiro Manago<sup>d</sup>, and Hiroaki Kuze<sup>d</sup>

<sup>a</sup>*Faculty of Engineering, Shizuoka University, 3-5-1 Johoku, Hamamatsu, 4328011 JAPAN*

<sup>b</sup>*Graduate School of Agricultural Science, Tohoku University, Aoba-ku, Sendai, 9818555  
JAPAN*

<sup>c</sup>*Graduate School of Agriculture, Kyoto University, Sakyo-ku, Kyoto, 6068502 JAPAN*

<sup>d</sup>*Center for Environmental Remote Sensing, Inage-ku, Chiba, 2638522 JAPAN*

---

### **Abstract**

Detection of vegetation fluorescence is important for understanding physiology of vegetation leaves in relation to photosynthetic activities. We have developed a stand-off system that enables the observation of vegetation fluorescence under both laboratory and field conditions. The intrinsic difficulty in monitoring weak fluorescence signal is the separation between the fluorescence signal around 740 nm and the large reflection of vegetation leaves in the near infrared (NIR) spectral region. In the laboratory measurement, it has been proven that a LED-based light source coupled with cold- or hot-mirrors can provide illumination with only visible or NIR part of the spectrum. The “pure” visible illumination, which is mostly free from the NIR radiation, can lead to the observation of fluorescence signals without hindrance from large NIR reflection. The NIR illumination, on the other hand, enables the evaluation of pure reflectance in NIR free from the fluorescence contribution. The combination of such pieces of spectral information makes it possible to implement the detailed analysis of solar radiation induced fluorescence signals. For field applications, a stand-off measurement system based on an astronomical telescope has been developed to carry out the spectral measurement using a CCD spectrometer, together with the two-dimensional measurement of the fluorescence intensity distribution by means of a cooled CCD camera. A narrow-band optical filter centered at 760 nm, the wavelength of the oxygen A-band, is employed with the CCD camera to exploit the “solar blind” wavelength for the fluorescence measurement under daylight conditions. We describe the application of the system to a soya-bean field in Kyoto University.

### **Keywords**

Vegetation fluorescence; Ground-based remote sensing; Canopy measurement;

---

### **1. Introduction**

Chlorophyll fluorescence emitted from vegetation under insolation yields valuable information on photosynthetic activities. It has been reported<sup>1,2)</sup> that high-resolution FITR spectrometers onboard satellites are capable of detecting fluorescence signals from surface

---

\* Corresponding author. Tel.: +81-53-478-1281; fax: +81-53-478-1281  
E-mail address: tsamasu@ipc.shizuoka.ac.jp

vegetation. For ground-based observations, instrumentations such as the use of UAVs<sup>3)</sup> and a crane tower above fields<sup>4)</sup> have been proposed and tested.

The present paper reports the results of our recent activity toward the realization of a system that enables remote sensing of vegetation fluorescence on the canopy level. The system is composed of an astronomical telescope, a compact CCD spectrometer, a cooled CCD camera, and narrow-band filters<sup>5,6</sup>. In order to carry out quantitative analysis, it is indispensable to validate the signal against both fluorescence and reflectance signals in the near infrared (NIR) region taken inside the laboratory, since the separation of these two contributions is essential. When an LED light source is employed in such a laboratory experiment, it is shown that the use of a cold mirror (good rejection of NIR and transmission of visible light) or a hot mirror (good rejection of visible light) can lead to ideal illumination conditions for separate observations of weak fluorescence signals and large signals arising from infrared reflectance. As an example of our recent field studies, here we describe the results of solar radiation induced fluorescence (SIF) conducted at a soybean field in Kyoto University with stand-off distances of 15-30 m.

## 2. Laboratory observation of fluorescence spectra

The light from an LED light source (35 W) was illuminated on a soybean (*Glycine max*) canopy prepared in a dark laboratory. Figure 1 shows the LED spectrum, which exhibits peaks around 450 and 550 nm, with relatively weak intensity at wavelengths longer than 700 nm (broken line). For further reducing the NIR intensity, the combination of a cyan filter and a hot mirror (transmitted light) was used to cut wavelengths longer than 620 nm (thin curve in Fig. 1). The resulting LED-induced fluorescence signal of the vegetation canopy exhibits a major peak at around 690 nm with a smaller peak at 690 nm (solid curve).

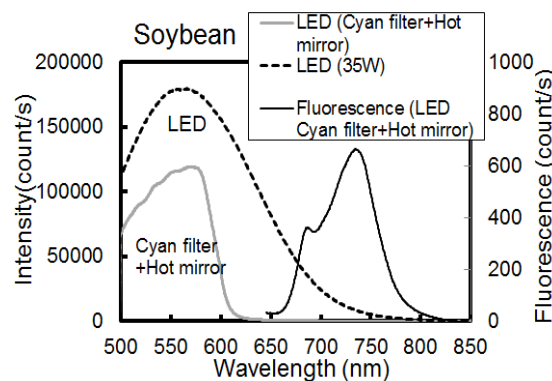

Fig. 1 Spectra of original and modified (cyan filter + hot mirror) LED light source shown with LED-induced fluorescence signal.

## 3. Stand-off measurement of SIF

The field measurement of soybean SIF was carried out at the experimental field of Kyoto University during September 1 -3, 2016. The cultivated Soybean types are Toyoyutaka and some other varieties. The observation under daylight conditions were carried out with an optical system developed in our group<sup>5,6</sup>. The main feature of the system is the capability of sharing nearly the same field-of-view (FOV) of a telescope with a compact spectrometer and a cooled CCD camera in a subsequent manner (Fig. 2) The diameter of the telescope is 200 mm, with an FOV coverage of 0.47 deg (full angle). The spectrometer is a cooled CCD spectrometer (Ocean Optics, QE65Pro) covering the wavelength range of 500-870 nm with a sampling interval of 0.1 nm. Typical value of the signal-to-noise ratio is as high as 1000:1. The spatial distribution of fluorescence intensity is detected with a cooled CCD camera (Bitran, BU51LIR) equipped with an optical filter centered at 760.68 nm with narrow-band transmission of 1 nm (FWHM) (Andover, hereafter F760).

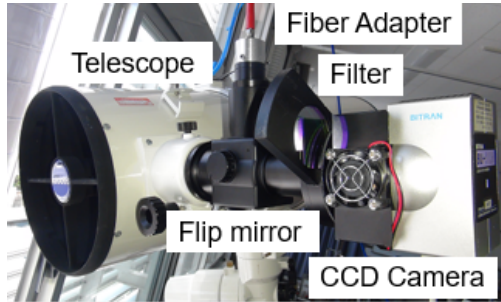

Fig. 2 Instruments used for the field observation of SIF

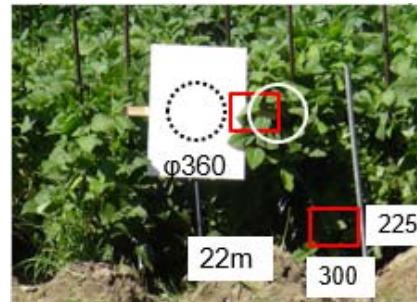

Fig. 3 Locations of the canopy and reference (whiteboard) observation.

For obtaining reference spectrum/image, the spectrum of solar radiation reflected from a home-made whiteboard (WB) of  $\sim 0.45 \times 0.6 \text{ m}^2$  was measured with the telescope system, for both the spectrometer and camera image measurement modes. Figure 3 shows the scheme of the reference measurement. In the case of the spectral measurement, the portion of the WB indicated by a dotted circle was employed and the resulting spectrum was compared with the vegetation signal taken by observing the position of the soybean leaves encircled with the white line. In the case of the image measurement, the rectangular area of  $\sim 0.30 \times 0.23 \text{ m}^2$  (marked with red line) was observed, the left part of which is covered by the WB.

Figure 4a shows the resulting spectrum from both soybean leaves (thin line) and the WB reference (solid line). In the spectral region of 825 - 850 nm, the effects of SIF and water vapor absorption are insignificant. Thus, the reflectance of target leaves relative to the reference WB is estimated from this region, as indicated with a dotted curve. Here the slight decline of WB reflectance toward the shorter wavelength was taken into account. Then, the difference between the soybean curve (thin line) and the scaled reference curve (dotted line) indicates the SIF signal, as illustrated in Fig. 4b. For the following discussion on the SIF intensity, we use the spectral intensity at 775 nm, which is mostly free from the effects of atmospheric absorption (i.e.,  $\text{O}_2$  and water vapor) and chlorophyll absorption.

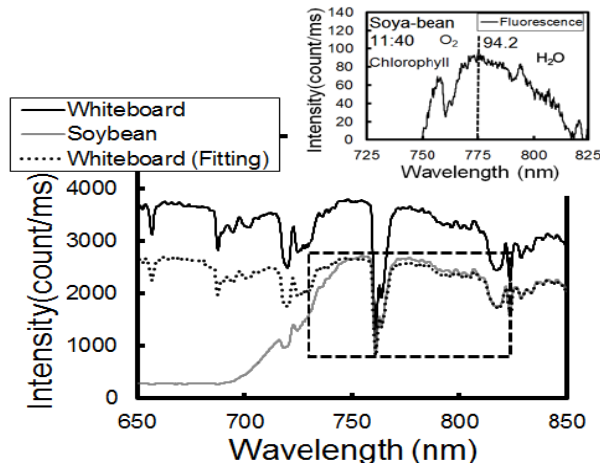

Fig. 4 Proposed Method of spectral fitting. In (a), the WB spectrum (solid line) is scaled to fit the vegetation spectrum (thin curve) using the wavelength range of 825 - 850 nm. Then, the resulting curve is subtracted from the canopy signal to obtain the SIF profile, as shown in the inset.

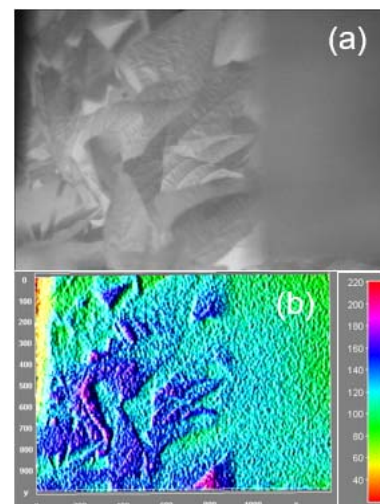

Fig. 5 (a) Soyabean field imagery and (b) fluorescence intensity calculated by subtracting the reference spectra after the scaling.

Figure 5 shows the spatial distribution of SIF. In this image, the right side shows the reflectance of the WB, while the left side the reflectance from the soybean canopy. The camera image was recorded by applying the narrow bandpass F760 filter. We assume the linearity between the pixel digital numbers (DNs) and radiation intensity, and the same scaling factor obtained in the case of Fig. 4a is applied to this case as well. Thus, the difference between the canopy DN and scaled reference DN gives the SIF intensity distribution as indicated in Fig. 5b.

The temporal change of the SIF intensity from both the spectral and camera measurements was compared with that of photosynthetically active radiation (PAR) recorded using a PAR meter (BMS 3415FXSE) (Figure not shown). Good agreements were seen among these three independent datasets, suggesting the direct relation between the PAR and fluorescence intensities during the observation time.

Figure 6a shows the reflectance image taken with the CCD camera attached with an interference filter having the central wavelength 550 nm and width 10 nm. The stand-off distance was 20 m, and the acquisition time duration was 30 ms. In this visible image, it is seen that generally strong reflection of solar radiation is observed for leaves that meet the specular reflection condition. Figure 6b, on the other hand, shows the SIF image taken by applying the F760 filter with the acquisition time of 50 ms. The color scale is assigned for the data expressed in units of  $\text{count ms}^{-1} \text{ pixel}^{-1}$ .

In the experimental field of Kyoto University, different varieties of soybean are planted column by column. Figure 7b, the red squares indicate the position of columns. As seen from Fig. 7, good agreement was seen for the SIF intensities determined from the spectral measurement and image analysis.

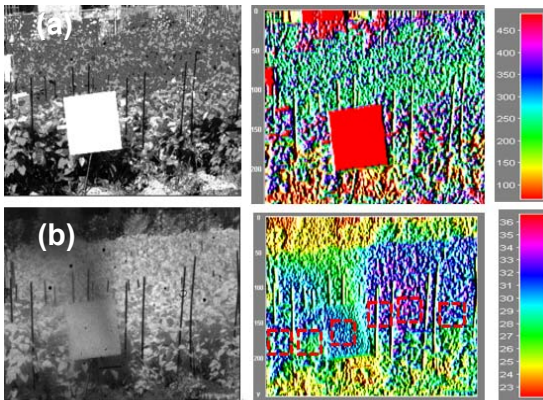

Fig. 6 (a) Reflection image observed at 550 nm and (b) fluorescence image observed at 760 nm.

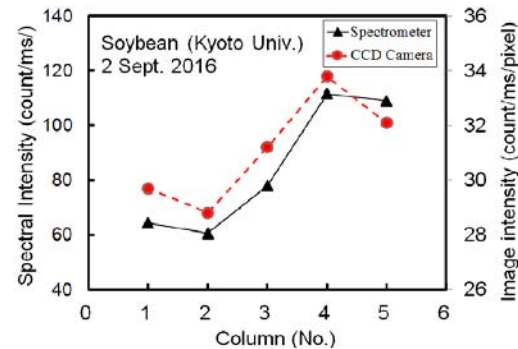

Fig. 7 Difference in fluorescence intensity observed for different varieties of soybean (14:10-14:30 on September 2, 2016)

In conclusion, we have described the SIF measurement from vegetation canopy under both laboratory and field conditions. The use of LED light source coupled with appropriate filter setup made it possible to separate the weak fluorescence intensity from much larger near-infrared reflectance of vegetation. In the field measurement, the scaling of the whiteboard reference worked well for deriving the fluorescence signals even under daylight conditions.

Acknowledgement: This work was financially supported by the Grant-in-aid from MEXT and CEReS Joint Research.

## References

- 1) L. Guanter et al.: *Geophys. Res. Lett.*, 34, L08401, doi:10.1029/2007GL029289 (2007).
- 2) C. Frankenberg et al.: *Geophys. Res. Lett.*, 38, L03801, doi:10.1029/2010GL 045896 (2011).
- 3) P.J. Zarco-Tejada et al.: *Remote Sensing of Environment* 117, pp. 322-337 (2012).
- 4) F. Daumard et al.: *IEEE Trans. Geosci. Remote Sens.*, 48, pp. 3358-3368 (2010).
- 5) K. Masuda (Kuriyama) et al.: WEP.N92, IGARSS Quebec (2014).
- 6) K. Kuriyama et al.: RSSJ 59th Autumn Meeting B-4 (2015)



---

**THE USE OF HYPERSPECTRAL DATA TO ANALYZE CLIMATE  
CHANGE ACCORDING TO CARBON STOCKS AND SOUTHEAST  
SULAWESI BIODIVERSITY**

**Sawaludin, Derick Christopher Ambo Masse, Muhammad Apdal, Hasmina  
Tari Mokui, Surya Kurniawan and Waode Nurhaidar, La Ode Restele\***

*Universitas Halu Oleo, Jl. H.E.A Mokodompit, Kendari 93232, Indonesia*

---

**Abstract**

Indonesian region is lately experiencing extreme weather resulting in deviant climate change. It is occurred due to the massive amount of carbon dioxide produced on this planet. As the consequence, the ozone layer protecting the earth from solar radiation becomes vulnerable and damaged. The existence of the green plants classified as forest biodiversity is expected to reduce the large amount of carbon dioxide gas by transforming it into oxygen through photosynthesis. Forest biodiversity in Southeast Sulawesi is categorized into tropical forest, savannah and mangrove forest. Each type of forest has different amount of carbon stock. Nowadays, information in relation to carbon stocks and forest biodiversity are needed for the analysis of climate change. The main objective of this research is to analyze climate change according to carbon stocks and forest biodiversity in Southeast Sulawesi by applying hyper spectral data. In order to distinguish the forest types and to comprehend its carbon potentials, unsupervised classification method is applied and correlated with the biomass carbon. Furthermore, it is analyzed using NDVI formula to determine the extent and density of vegetation and carbon potential existing in an area. Further analysis is conducted by utilizing weather parameter of air pressure observation data, air temperature data, and weather satellite data to discover monthly average weather conditions semi-objectively. The results obtained, will enable this research to analyze climate change in order to provide early prevention efforts.

*Keywords: Biodiversity, Carbon, Climate, Weather, Hyperspectral.*

**1. Introduction**

Indonesia is developing country located in Asian continent and situated right at the equatorial line. Having such geographical condition, Indonesian certainly has a very large area of forest. One location in Indonesia with large forest area is in Southeast Sulawesi and it can be categorized into tropical, mangrove and savanna forest.

Tropical forest is inhabited by more than 50% of total species of plants in the world (Whitmore. 1990, Foody. 2003, Thomas et al 2004). However, detailed spatial

---

\*Derick Christopher Ambo Masse. Tel.: +62-853-9414-7195.  
E-mail address: derickchristopher.ams@gmail.com

information about composition and distribution of tree and its fauna diversity is still limited to some areas (Clark et al. 2005). Similarly, both mangrove and savanna forests occupy large distribution area and have their own roles as well. For example, mangrove plays important role on coast productivity (Analudin. 2016).

For remote sensing scientist, satellite data can be used to assess biodiversity (Lucas et al.) and to contribute on dead and living carbon assessment (Asner and Heibretch, 2002).

Based on those facts, the main objective of this research is to analyze climate change based on biomass reserve and plant diversity in South east Sulawesi. In particular, this research is aimed: (1) to estimate biomass carbon existence (2) to find out what climate change will happen by analyzing biomass existence in Southeast Sulawesi forests.

## 2. Material and Methods

### 2.1. Location

Location of this research is the whole region of Southeast Sulawesi (Figure 1) with astronomic position is between 02°45'-06°15' South Latitude and 120°45'-124°45' East Longitude (Biro Humas. 2013).

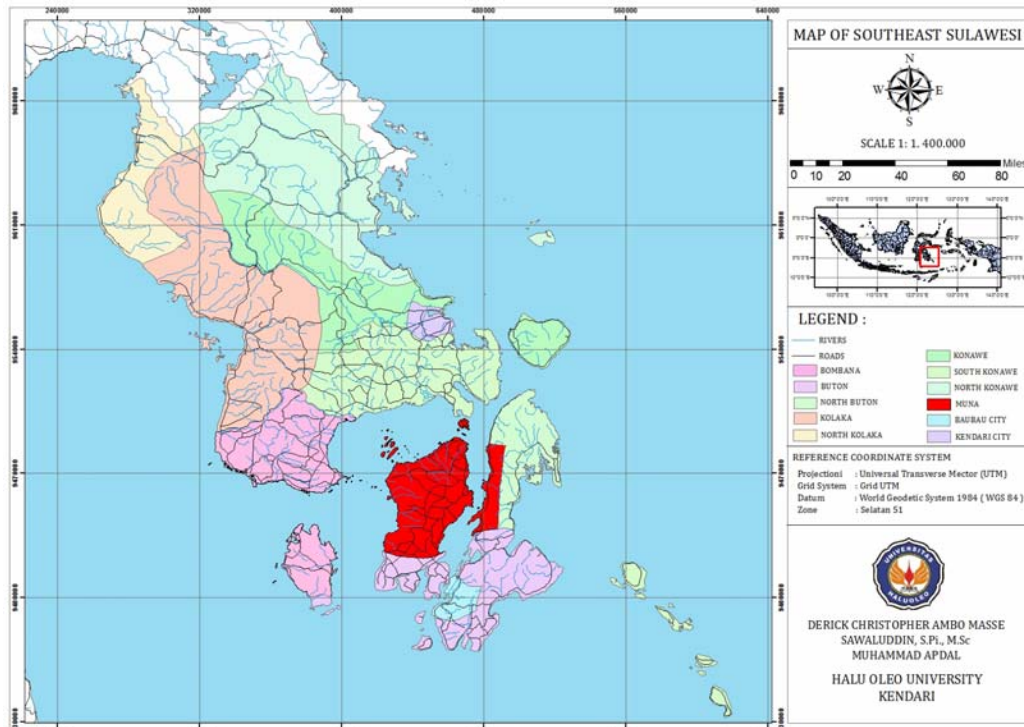

Figure 1. Southeast Sulawesi Map.

## 2.2. Image Processing

First stage of image processing of Landsat 8 is geometric and radiometric correction. Image correction is a conditioning operation so that the image to be used can really provide accurate information geometrically and radiometrically (Danoedoro. 1996).

After being corrected, the image will be analyzed using Normalized Difference Vegetation Index (NDVI) formula to get vegetation density point (Jensen. 1996). Next stage is a classification process to classify and separate each areas based on their own ecosystem vegetation types.

## 2.3. NDVI Analysis

Vegetation index can be used to measure biophysics parameter such as biomass, chlorophyll, LAI (Leaf Area Index), etc. (Jensen. 1996). To separate vegetation and non vegetation on satellite imaging, normalized difference vegetation index method is used (Gougeon and Leckie. 2003, Danoedoro. 1996), with equation as follows:

$$NDVI = \frac{IR - R}{IR + R} \quad (1)$$

Next, correlation analysis will be conducted to seek for relationship between vegetation density and area use. At this step, the new analysed image will be produced and then classified into tropical, mangrove or savannah forest. In order to interpret the relationship between two variables, the relationship power correlation criteria (Table 1) is applied (Rahmi. 2009).

Score	Correlation relationship
0	No correlation
0.1 - 0.25	Very weak correlation
0.26 - 0.5	Medium correlation
0.51 - 0.75	Strong correlation
0.76 - 0.99	Very strong correlation
1	Perfect correlation

## 2.4. Biomass and Carbon Stock Estimation

Forest carbon total reserve measurement is based on biomass total content measurement and organic stuff at carbon pool (IPCC. 2003). Carbon biomass estimation on land surface is calculated by building up allometric equation (ministry of forestry. 2013). Applied allometric equation is:

$$B = V_{pohon} \times WD \times BF_{pohon} \quad (2)$$

To calculate tree volume, geometric equation is used by considering tree height and diameter data as follows:

$$V = 0,25\pi \times \left(\frac{D}{100}\right)^2 \times H \times F \quad (3)$$

Carbon stock estimation based on biomass needs biomass conversion factor value which is called as carbon fraction (forestry ministry. 2013), formulated as:

$$Stok\ Karbon = Fraksi\ Karbon \times Biomassa \quad (4)$$

Carbon fraction value applied in Equation (4) is 0.47 (IPCC. 2003).

## 2.5. Climate Change Analysis

Climate change is analyzed by using temperature parameters data of air and rainfall to know the average annual weather conditions on a semi-objective scale.

## 3. Results and Discussion

### 3.1. Image Correction

Image correction is the first step on preparing the data before doing analysis in order to find out the index value of vegetation density. The whole process of image correction as follows: (1) applying geometric correction of image to reflate the image within its real position; (2) applying radiometric correction to reflate pixel value that was damaged due to errors while recording the image. The result of radiometric correction can be seen at Figure 2.

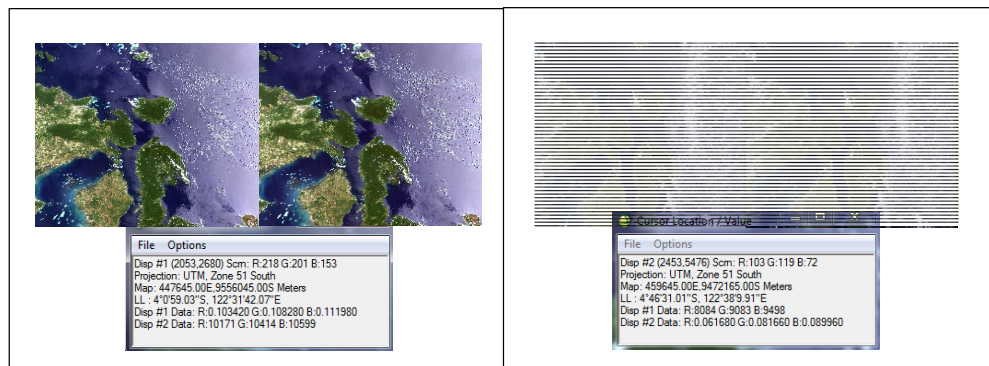

Figure 2. (a) Image pieces of Landsat Southeast Sulawesi 2016; (b) Image pieces of Landsat Southeast Sulawesi 2006

### 3.2. Vegetation Density Index Value and Forest Type Classification

Vegetation density index value is obtained by taking 200 samples, selected randomly in Southeast Sulawesi region through satellite imaging. In addition, its physical condition is also checked in detail by exporting existing points of investigated image into Google Earth Software. Then, analyzed vegetation physical condition is adjusted to density classification index that is already determined (Table 2).

Tabel2. Vegetation density index value classification

Density rate	Interval	Value
High density	0,8 - 1	91 - 100
Medium density	0,5 - 0,79	61 - 90
Low density	0,2 - 0,49	31 - 60
Not vegetated	-1 - 0,19	0 - 30

Point selection is conducted within two different images having 10 year time interval, i.e. Landsat 7 in 2006 and Landsat 8 in 2016. Selecting similar points is intended to see the trend of field cover change. The comparison result shows a very significant result. In 2006, vegetation density rate is 0.68005 while in 2016, it is 0.476378.

Based on the result, it can be seen that the field cover change in 10 years is 0.203674. It happened because there was added space for housing, mining, palm oil plantation and many more purposes in Southeast Sulawesi.

After finding the field cover change or vegetation trend in Southeast Sulawesi, correlation analysis is applied. In the correlation analysis, the density index value is compared to field cover change value. Correlation relationship is indicated in correlation coefficient ( $r$ ) and determination coefficient ( $R^2$ ). Determination coefficient shows linear relationship between NDVI result and field use value based on already determined scoring.

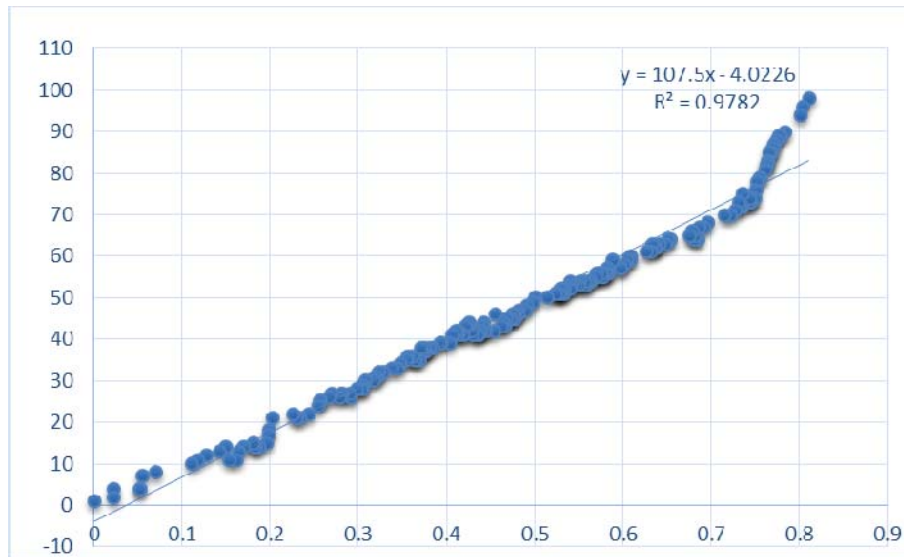

Figure 3. Index Value Of Vegetation Density in 2016.

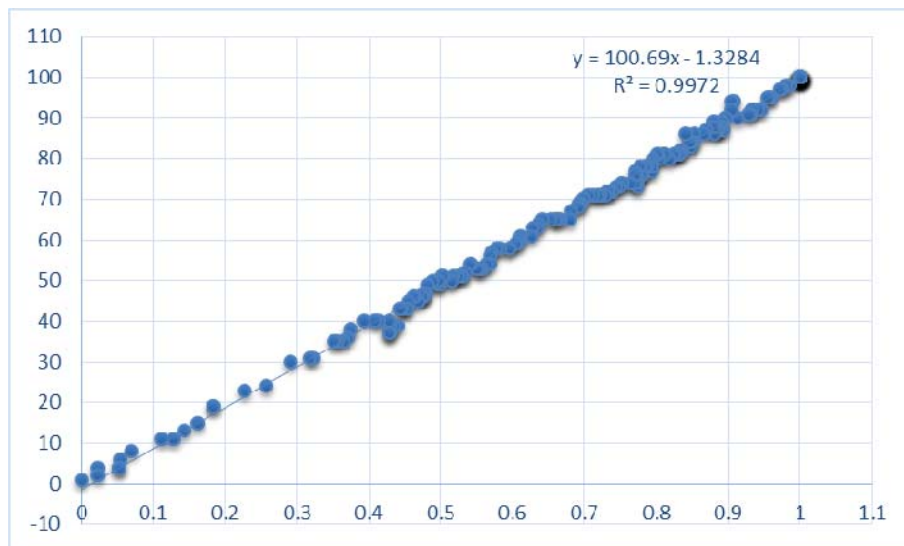

Figure 4. Index Value Of Vegetation Density in 2016.

In 2016, determination coefficient value is 0.9782, while in 2006, its determination coefficient value is 0.9972. It is obvious from the number of determination coefficient that investigated variables has a strong relationships, as can be seen on Figure 2 and Figure 3. This confirms the theory that the more determination coefficient, the stronger relationships between investigated variables (Hafish. 2013) and without considering the algebra sign, determination coefficient moves between -1 to 1.

Based on correlation analysis, it is known that determination coefficient has a very high value. Later, that value is used to predict extents for each ecosystem, i.e. tropical, mangrove and savanna forest.

### 3.3. Biomass and Carbon Stock

Standing Biomass calculation is conducted at each ecosystem (Tropical, Mangrove and Savanna). Both for tropical and mangrove forests, measurement is conducted as much as 3 times covering different areas. Except in savanna forest, measurement is only one time.

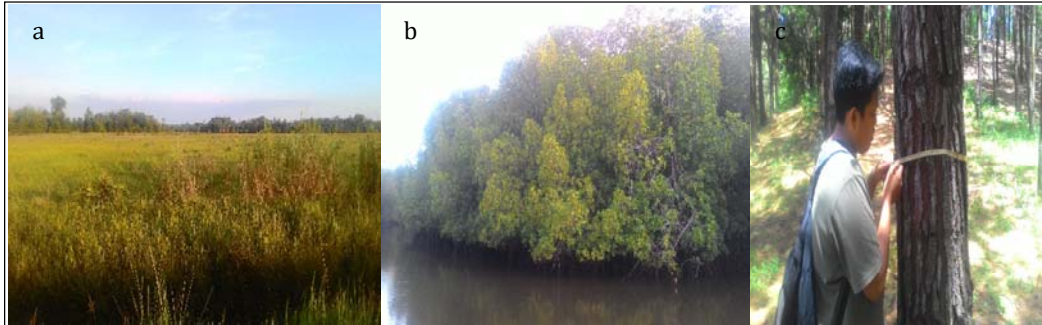

Figure 5. (a) Savanna Ecosystem; (b) Mangrove Ecosystem; (c) Tropical Ecosystem.

Standing Biomass in Plot 1, created at area of 60 m x 60 m of tropical forest ecosystem is 6.516.08tonHa<sup>-1</sup>. This result is based on the allometric formula which has been developed previously. In plot 2, founded standing Biomass based on similar formula and equal plot dimension is 7.214.45 tonHa<sup>-1</sup>. While in the Plot 3 (applying similar formula and size of plot), the result of standing biomass is 6.241.79 tonHa<sup>-1</sup>.

In calculating the standing Biomass of mangrove ecosystem, each plot was created at area of 30 m x 30 m. Based on the allometric formula, obtained the total biomass of plot 1 is 3.328.83tonHa<sup>-1</sup>. While standing biomass for plot 2, is 4.963.75tonHa<sup>-1</sup> and standing biomass for plot 3 is 3.158.48 tonHa<sup>-1</sup>.

Biomass of savanna forest ecosystem is calculated by doing measurement in the field, i.e. making plot with area of 30 m x 30 m. Furthermore, recreate a new small plot (1 m x 1 m) within the aforementioned plot. In savanna ecosystem, standing biomass calculation is conducted by cutting down all individuals within the small plot 1m x 1 m and then measure the wet weight accordingly. About 300 g of the total individuals is separated and treated as wet weight sample. Furthermore, the selected wet weight sample is heated in the oven with temperature 85°C to find out the dry weight. In order to calculate Biomass in Savanna ecosystem, the total dry and wet weights are multiplied and then it is divided with wet weight sample. The final result obtained from biomass calculation of savanna ecosystem within the selected plot is 112 ton Ha<sup>-1</sup>.

Once standing biomass is known, total biomass in Southeast Sulawesi can be calculated based on the total area of each forest ecosystem type that has been set. Calculation of total biomass is conducted by multiplying the total of standing biomass with total area of each forest ecosystem type. The total biomass in Southeast Sulawesi for each forest type are as follows: (1) tropical forest ecosystem is 34.966.097.079.72tonHa<sup>-1</sup>; (2) mangrove forest ecosystem is 4.611.721.676.15tonHa<sup>-1</sup>; and (3) savanna forest ecosystem of biomass is 7.653.520 tonHa<sup>-1</sup>.

Furthermore, based on total biomass in Southeast Sulawesi, the carbon stock can be calculated by using carbon stock formula value 0.47 as the carbon fraction value set by the Intergovernmental Panel on Climate Change (IPCC). The result shows that Carbon Stock for tropical forest in Southeast Sulawesi 16.434.065.627.47tonCHa<sup>-1</sup>. In addition, Carbon Stock for Mangrove Forest is 2.167.509.187.79 ton CHa<sup>-1</sup>. While, for the savannah forest ecosystem, the carbon stock is 3.597.154.40 ton CHa<sup>-1</sup>. Table 3 shows the total results for biomass and Carbon Stock Calculation.

Table 3. Biomass and Carbon Stock of Southeast Sulawesi

Type of Ecosystem	Biomass Plot Area (Ton/Ha)	Total Biomass (Ton/Ha)	Total Carbon Stock (TonC/Ha)
Tropical Forest	6.516.08	34.966.097.079.72	16.434.065.627.47
	7.214.45		
	6.241.79		
Mangrove Forest	3.328.83	4.611.721.676.15	2.167.509.187.79
	4.963.75		
	3.158.48		
Savanna Forest	112	7.653.520	3.597.154.40

Based on Table 3, it can be concluded that the largest number of carbon stock in Southeast Sulawesi is at tropical forest ecosystem and respectively followed by mangrove forest ecosystem and savannah forest ecosystem.

### 3.4. Impacts of Biomass Carbon Stock Change to Climate Change

Climate change can be detected through temperature and rainfall which occur everyday. The following is data used in this research (Table 4) taken from Kendari Meteorology and Maritime Climatology Station and then converted into annual average climate condition. Figure 6 shows the graph of monthly average climate data. There are 3 stations in Southeast Sulawesi but the weather data is only taken from Kendari Station to represent other parts of Southeast Sulawesi region, as there is no significant weather differences among parts of the aforementioned region.

Table 4. Weather Annual Average in Kendari Municipality

Year	Annual Average of Temperature	Annual Temperature Max	Annual Rainfall
2008	27.04	31.21	7.48
2009	26.58	31.02	5.85
2010	26.68	31.07	6.79
2011	26.90	31.40	4.80
2012	27.21	31.04	4.74
2013	27.34	31.52	4.67
2014	27.12	31.68	2.99
2015	26.89	31.60	5.48

According to data from Kendari Station, during the last 8 years, there is a rising trend in the average annual temperature. This is due to deforestation activities happening across Southeast Sulawesi Region. Deforestation is the main cause of climate change because it reduces the number of forest plants functioning to absorb carbon dioxide. As the result, the ozone layer at the atmosphere becomes damaged.

According to Biomass Carbon Calculation that has been done, Southeast Sulawesi forests can only absorb and temporarily save less than 18 billion tonnes of carbon. There is a significant difference as compared to forest condition in Southeast Sulawesi from 10

years ago. The satellite imaging applied for this research also confirms that there is significant change of land cover condition within the last 10 years.

As can be seen from Table 4, the maximum temperature in Kendari Municipality has increased by 0.1°C per year. Meanwhile, the rainfall experiences a downturn every year. This research brings up consequences to the upcoming years that Southeast Sulawesi Region will experience more dryness, particularly in Kendari Municipality.

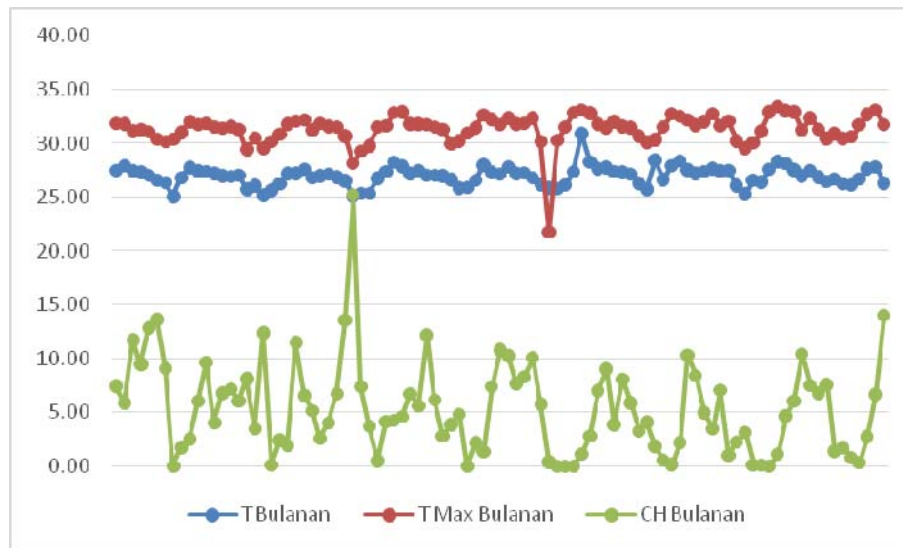

Figure 6. Monthly Average Weather Condition of Kendari Municipality.

Besides dryness, seasonal change also becomes uncertain. As can be seen in 2014, the Southeast Sulawesi region experienced prolonged EL Nino condition causing some parts in the region suffered due to dryness. In addition, in 2013, the prolonged La Nina caused floods in some parts of Southeast Sulawesi region, including Kendari Municipality.

According to the climate change projection from IPCC, the global temperature will rise by 2°C in 2050. This prediction might happen faster due to fast deforestation practices causing less forest area. Therefore, it is predicted that hydro meteorological hazards in Indonesia will increase.

In conclusion, the choice in the future toward change climate issues is how to do mitigation or risk reduction as well as to adapt with the change on earth. There are several promising programs can be done, such as Carbon Bank, reforestation, or finding new invention to reduce the rate change of land cover. However, the most important thing is commitment of all people to prevent global warming.



## REFERENCES

- Analuddin, K, et al. (2016). Blue carbon stock and green tea potential in mangroves of coral triangle eco-region, Southeast Sulawesi, Indonesia. *Int. J. of Environmental Science*, Vol. 1, No. 2367-8941. Kendari, Indonesia.
- Asner, G.P. and Heidebrecht, K.B. (2002). Spectral unmixing of vegetation, soil and dry Carbon cover in arid regions; comparing multispectral and hyperspectral observations, *Int. J. of Remote Sensing*, Vol. 23.
- Biro Humas dan PDE. (2013). Geografis Sulawesi Tenggara. Indonesia. <http://www.sulawesitenggaraprov.go.id>. Last Accessed 12 October 2016.
- Clark, D.A., Roberts, D.A., and Clark, D.A. (2005). Hyperspectral discrimination of tropical rain forest tree species at leaf to crown scales, *Remote Sensing of Environment*, Vol. 96.
- Danoedoro, P. (1996). Pengolahan Citra Digital. Fakultas Geografi, UGM, Indonesia.
- Foody, G. (2003). Remote sensing of tropical forest environments: Towards the monitoring of environmental resources for sustainable development, *Int. J. of RemoteSensing*, Vol. 24, No. 20, 4035. Southampton, United Kingdom.
- Gougeon, F.A. and Leckie, D.G. (2003). Forest information extraction from high spatial resolution images using an individual tree crown approach. Information Report Bc-X-396, Natural Resources Canada, Canadian Forest Service, Victoria, BC.
- Hafish, A.S, et al. (2013). Penggunaan Algoritma NDVI dan EVI Pada Citra Multispektral untuk Analisa Pertumbuhan Padi, Studi Kasus Kabupaten Indramayu, Jawa Barat. *Jurnal Teknik Pomits*. ITS, Indonesia.
- Jensen, J.R. (1996). *Introductory Digital Image Processing: A Remote Sensing Perspective*, 3rd edition. Prentice Hall, Inc. London.
- Kementrian Kehutanan. (2013). Pedoman Penggunaan Model Alometrik Untuk Pendugaan Biomassa dan Stok Karbon Hutan di Indonesia, Pusat Penelitian dan Pengembangan Konservasi dan Rehabilitasi, Badan Penelitian dan Pengembangan-Kementrian Kehutanan, Indonesia.
- Lucas, R.M., Bunting, P., Paterson, M., et al., Classification of Australian forest Communities using aerial photography, CASI and HyMap data, *Remote Sensing of Environment*, in press.
- Rahmi, J. (2009). Hubungan Kerapatan Tajuk dan Penggunaan Lahan Berdasarkan Analisis Citra Satelit dan Sistem Informasi Geografis di Taman Nasional Gunung Leuser. Universitas Sumatera Utara, Medan, Indonesia.
- Thomas, C.D, et al. (2004). Extinction risk from climate change. No. 427(6970). *Nature*. USA
- Whitmore, T.C. (1990). *An introduction of tropical rain forests*. Clarendon, Oxford, England.

---

## **Polarimetric analysis of long term paddy rice observation using ground-based SAR (GB-SAR) system**

Yuta izumi<sup>a\*</sup>, Tomorou Watanabe<sup>a</sup>, Mohd Zafri Baharuddin<sup>b</sup>, Sevket Demirci<sup>c</sup>, and Josaphat Tetuko Sri Sumantyo<sup>a</sup>

<sup>a</sup>*Center for Environmental Remote Sensing (CERES), Chiba University, 1-33, Yayoi, Inage, Chiba 263-8522, Chiba Japan*

<sup>b</sup>*Department of Electronics and Communication Engineering, College of Engineering Universiti Tenaga Nasional, Jalan IKRAM-UNITEN 43000 Kajang, Selangor, Malaysia*

<sup>c</sup>*Department of Electrical-Electronics Engineering, Mersin University, Ciflikkoy 33343, Mersin, Turkey.*

---

### **Abstract**

The synthetic aperture radar (SAR) has been utilized for generating image of the earth surface by synthesizing the antenna along the azimuth flight pass as signal processing. This technique recently provides us abundant information by using the polarimetric data of linear polarized (LP) antennas. In recently, Josaphat Microwave Remote Sensing Laboratory (JMRS�) developed ground-based SAR (GB-SAR) for precise monitoring of several targets and SAR experiment inside an anechoic chamber. In this paper, we introduce the paddy rice observation by using the developed GB-SAR system and that of polarimetric analysis. To observe the paddy rice using SAR is very promising since SAR observation doesn't face the problem of whether condition. We conducted the paddy rice observation experiment inside an JMRS� anechoic chamber. More accurate results can be corrected than SAR onboard satellite by testing inside the anechoic chamber and using the GB-SAR with wideband frequency. The GB-SAR is comprised of vector network analyzer (VNA), quad ridged horn antennas, and position controller. The SAR image was reconstructed by back projection algorithm with inverse SAR (ISAR) experimental method for high resolution image. We have observed the paddy rice from beginning of the June until end of September to analysis according to the growth stages. As a polarimetric analysis, we applied model based decomposition technique in linear polarization (LP) basis proposed by Yamaguchi to each SAR images. The result from series of measurements show strong dependency on the off-nadir angle and unignorable high helix scattering effect.

### **Keywords**

SAR; GB-SAR; Polarimetry; Paddy rice.

---

## **1. Introduction**

The synthetic aperture radar (SAR) is imaging radar which can obtain interest target by collecting scattering signals along the azimuth line. Since this technique uses

---

\* Corresponding author. Tel.: +81-80-1671-9266.  
E-mail address: yutaizumi0927@gmail.com

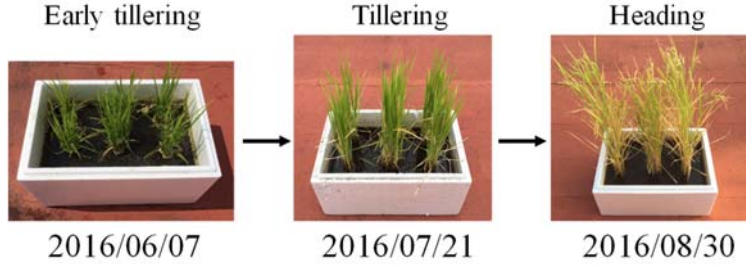

Fig. 1. Photograph of paddy rice according to the growth stages.

Table 1. List of paddy rice height according to the observation date.

Test date	Jun.7	Jun.22	Jul.6	Jul.21	Aug.3	Aug.22 (ear emergence)	Aug.30	Sep.14
Height [cm]	19	27	34	42	49	52	52	45

microwave as transmitting signal, it can generate the images without consideration of weather condition and observation time.

The polarimetric information obtained by polarimetric synthetic aperture radar (polSAR) becomes important factor for observation of paddy field. Until now, several papers have investigated the relationship between microwave scattering and growth stage of paddy rice using polSAR data of SAR onboard satellite and aircraft and ground-based SAR (GB-SAR) (Hayashi and Sato, 2009), (Li et al., 2012). The paddy rice observation by using especially GB-SAR can select variety of frequencies and use wide frequency range, compared to SAR onboard satellite and aircraft (Hayashi and Sato, 2009). However, few papers have studied long term paddy rice observation of GB-SAR until now.

In this paper, we conduct polarimetric analysis of long term paddy rice observation (beginning of June until end of September) according to the seasonal growth stage by using developed GB-SAR system inside of an anechoic chamber. As the polarimetric analysis, we applied four component decomposition technique which decomposes the scattering power to several scattering mechanisms such as surface, double-bounce, volume, and helix scattering proposed by Yamaguchi et al. (Yamaguchi et al., 2005)

## 2. Four component polarimetric SAR image decomposition

Depends on the target geometry, scattering mechanism which is characterized by the scattering matrix of polarimetric SAR data is determined. Scattering matrix in linear polarization basis has four complex coefficients: HH, HV, VH, and VV of linear polarization where each coefficient of amplitude and phase is determined by scattering mechanism of interest target. The polarimetric SAR data has advantage of characterizing scattering mechanism of specific target by adopting decomposition technique. Four component polarimetric SAR image decomposition is one of the promising decomposition techniques which is proposed by Yamaguchi *et al.* This technique decomposes into four scattering mechanism categories of surface, double-bounce, volume, and helix scattering by using the coherency or covariance matrix. Here for example using well known covariance matrix of each scattering mechanism, the measured covariance matrix  $\langle [C] \rangle$  ( $\langle \cdot \rangle$  denotes the ensemble average) in HV-basis (linear polarization basis) can be decomposed as

$$\langle [C] \rangle^{HV} = f_s \langle [C] \rangle_{surface}^{HV} + f_d \langle [C] \rangle_{double}^{HV} + f_v \langle [C] \rangle_{volume}^{HV} + f_c \langle [C] \rangle_{helix}^{HV} \quad (1)$$

where  $f_s$ ,  $f_d$ ,  $f_v$ , and  $f_c$  are defined as constant number of surface, double-bounce, volume, and helix scattering respectively. The four component decomposition process can be

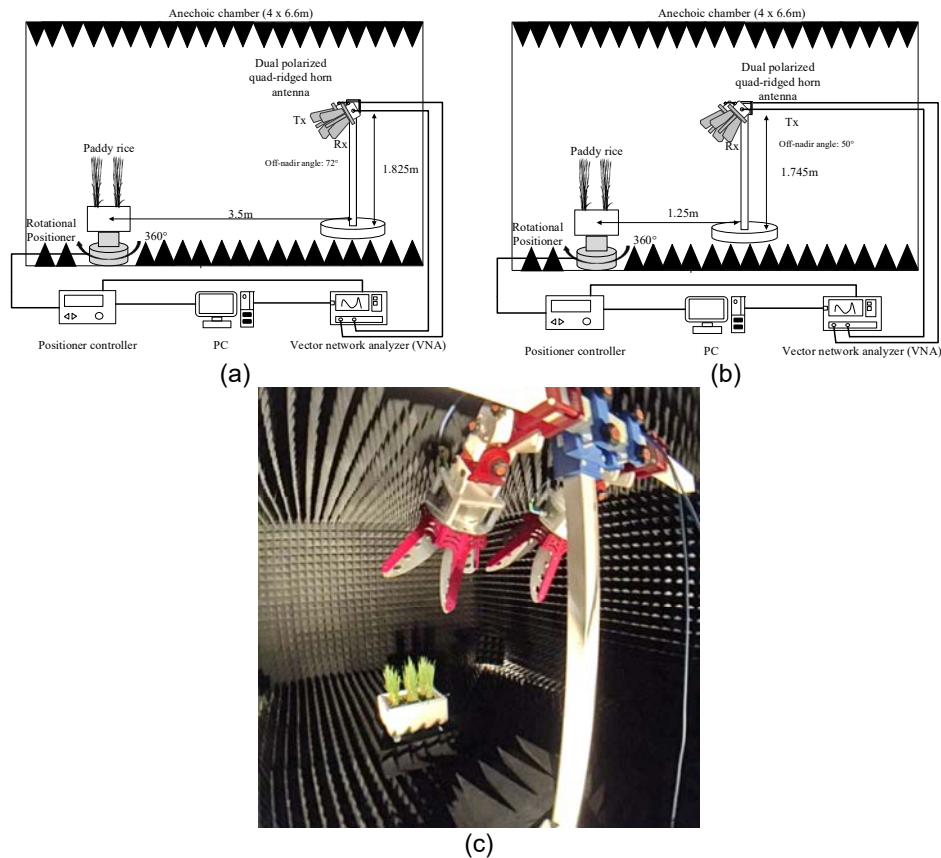

Fig. 2. Constructed GB-SAR system network inside the anechoic chamber. (a) Geometry with 72° off-nadir angle (b) Geometry with 50° off-nadir angle (c) Photograph from actual experiment with 50° off-nadir angle.

done after deriving four constant number of each power of scattering mechanism. More specific decomposition process can be referred from (Yamaguchi et al., 2005).

### 3. Experiment

To analyze the paddy rice using polarimetric decomposition technique, 8 times of paddy rice observation data were collected from June 7th until September 14th of 2016. These observations were conducted by using paddy rice as a target and developed GB-SAR system. To analyze the incidence angle dependency, the measurements were carried out with two specific off-nadir angles: 72° and 50°. Note that the primary measurement of June 7th miss the 50° off-nadir angle measurement data because of corrupt data.

#### 3.1. Paddy rice

We had cultivated the paddy rice from early tillering stage until harvesting in outside of our laboratory, as shown in Fig. 1. By cultivating our-self, every parameter related to paddy rice such as water and soil amount can be controlled easily. In addition, we can bring it into the anechoic chamber, and thus observation becomes possible with controlled environment. 6 paddy rice which are planted inside of the polystyrene box with 13.5cm height of soil and 14.5cm of water are used to suppress the undesired backscattering from the box. The paddy rice height according to the observation date are listed in Table 1. Ear emergence started from Aug. 22.

#### 3.2. Polarimetric GB-SAR system

The developed GB-SAR system is constructed by a vector network analyzer (VNA), a positioner controller, a rotational positioner, a PC, and quad-ridged horn antennas, as

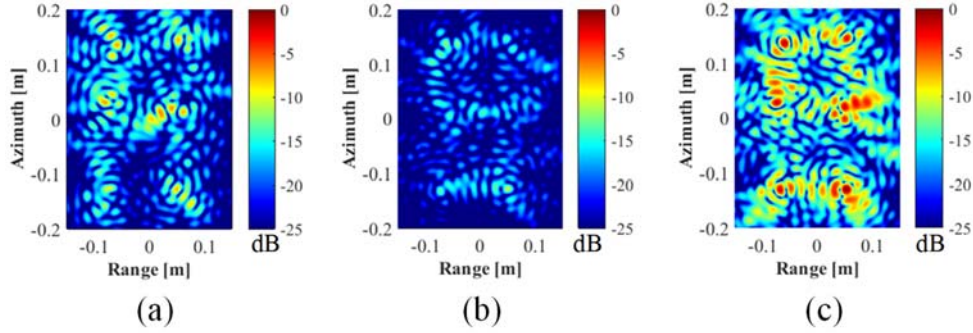

Fig. 3. Generated SAR images with 50° off-nadir angle obtained in Sep.14. (a) HH (b) HV (c) VV

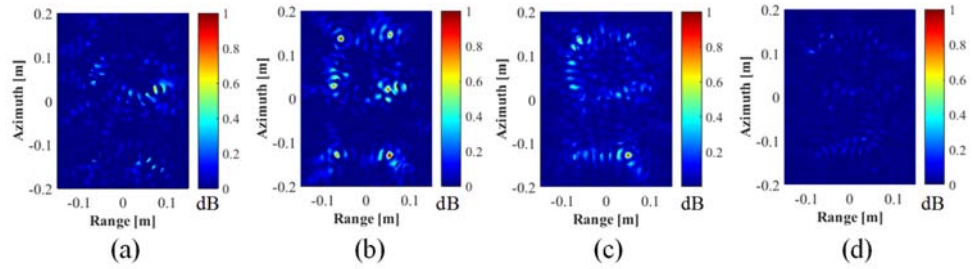

Fig. 4. Decomposed SAR images with 50° off-nadir angle obtained in Sep.14. (a) Surface scattering (b) Double bounce scattering (c) Volume scattering (d) Helix scattering

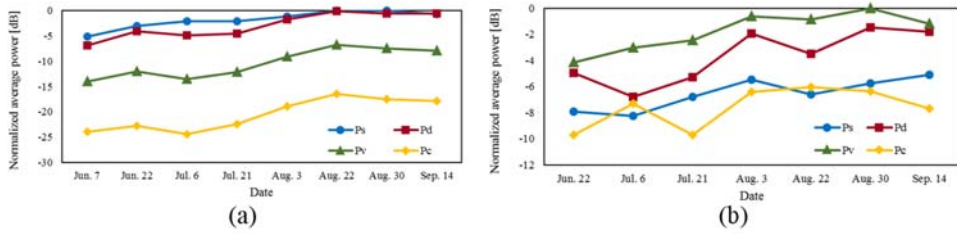

Fig. 5. The normalized average power. (a) off-nadir 72°. (b) off-nadir 50°.

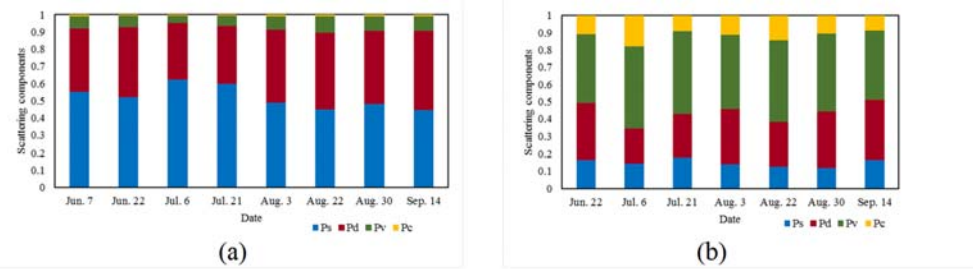

Fig. 6. Relative scattering components of Ps, Pd, Pv, and Pc. (a) off-nadir 72°. (b) off-nadir 50°.

shown in Fig. 2. This setup achieves a stepped frequency continuous radar (SFCW) configuration and wide-band observation since the antennas can be used in frequency range from 700 MHz until 10 GHz. The inverse SAR (ISAR) method, where target rotates in static place while SAR collecting the receiving data, was adopted to this observation. Because the target is in the antenna footprint all time during the measurement, this method is considered as spotlight mode and can obtain high resolution images compared to stripmap GB-SAR measurement.

## 4. Experimental results and discussion

The generated SAR images with 50° off-nadir angle which is obtained in Sep.14 are shown in Fig. 3 as representative of many images. These images are normalized to 0 dB as choosing a maximum value among three images. HH, HV, and VV polarization images are placed in Fig. 3 respectively. Fig. 3 shows the clear dots which represent the planted place of paddy rice. In addition, this figure shows highest scattering from VV-polarization because paddy rice stands as vertical shape.

Fig. 4 shows the images which is decomposed to each power component of Ps (surface scattering), Pd (double-bounce scattering), Pv (volume scattering), and Pc (helix scattering) from SAR images of Fig. 3. Furthermore, we calculated average power values from each decomposed power image and performed normalization to the maximum power in whole values, shown in Fig. 5, and scattering component rate is shown in Fig. 6. From these figures, the obvious difference between two off-nadir angles are observed. The measurements with 72° off-nadir angle indicate that the surface and double-bounce scattering are dominant among the 4 scattering components while the measurements with 50° show the highest volume scatterings and unignorable high helix scattering (Figure 6). This result indicates that the helix scattering is also one of the important factor for paddy rice monitoring, although many literatures have discussed paddy rice monitoring without considering of Pc scattering until now.

Although the seasonal results show strong dependency on the off-nadir angle, characterizing the paddy rice according to the observation time is not enough. Therefore, further analysis such as H/ $\alpha$  decomposition is planned to conduct.

## 5. Conclusion

Seasonal paddy rice observations have been conducted by using pol-GB-SAR with two specific off-nadir angles. The 6 paddy rice which are planted inside of the polystyrene box are used in the measurement. To perform the polarimetric analysis, four components polarimetric SAR decomposition technique is processed in each SAR images. The seasonal results show high dependency on the off-nadir angle in the paddy rice observation and unignorable helix scattering effect for observing paddy fields. However, the decomposition analysis is not enough to characterize the paddy rice according to the observation date. Therefore, more analysis will be performed as a next step of this study.

## Acknowledgements

This work was supported in part by the European Space Agency Earth Observation Category 1 under Grant 6613, by the 4th Japan Aerospace Exploration Agency (JAXA) ALOS Research Announcement under Grant 1024, by the 6th JAXA ALOS Research Announcement under Grant 3170, by the Japanese Government National Budget (Special Budget for Project) FY 2015 under Grant 2101, Taiwan National Space Organization under Grant NSPO-S-105096; Indonesian Bhimasena, and by the Chiba University Strategic Priority Research Promotion Program FY 2016..

## References

- Hayashi, N., and Sato, M. (2009). Measurement and analysis of paddy field by polarimetric GB-SAR. In *2009 IEEE International Geoscience and Remote Sensing Symposium* (Vol. 4, pp. IV-358). Cape Town, IEEE.

- Yamaguchi, Y., Moriyama, T., Ishido, M., and Yamada, H. (2005). Four-component scattering model for polarimetric SAR image decomposition, *IEEE Transactions on Geoscience and Remote Sensing*, Vol. 43, No.8, pp. 1699-1706. IEEE, USA.
- Li, K., Brisco, B., Yun, S., and Touzi, R. (2012). Polarimetric decomposition with RADARSAT-2 for rice mapping and monitoring, *Canadian Journal of Remote Sensing*, Vol. 38, No. 2, pp. 169-179. Canadian Science Publishing, Canada

---

**Exploring Attractive Landscape Elements and Sceneries of Bukit  
Kucing Forest Tanjungpinang by using Visitors-Employed  
Photography Method**

Akhmad Arifin Hadi<sup>a\*</sup>, Yusuke Mizuuchi<sup>b</sup>, Katsunori Furuya<sup>c</sup>

<sup>a</sup>*Bogor Agricultural University, Jl. Meranti Faperta IPB Dramaga Bogor 16680, Indonesia*

<sup>b</sup>*The University of Tokyo, 489-0031 Aichi-ken Seto-shi, Goizukacho 11-44, Japan*

<sup>c</sup>*Chiba University, 271-8510 Chiba-ken Matsudo-shi 648, Japan*

---

**Abstract**

The Bukit Kucing Forest (BKF) is a protected areas preserved in the middle of Tanjungpinang City, Indonesia. As an open protected area, the BKF is being managed for public recreation instead of wildlife protection and forest conservation. The visitor-employed photography (VEP) method was implemented in this research by involving 61 university students who study in universities in Tanjungpinang city. The participants were asked to walk following predetermined tracks and capture landscape objects or sceneries that impressed them during walking. Each participants used their own camera or smartphone with camera and each of them were attached a GPS logger to record their path and the time it took. All photos captured by participants were copied to researchers desktop in order to be object of the research. Each photos obtained from respondents were matched between captured time and walking time to obtained geo-tagged photos. There were 1,259 geo-tagged photographs obtained from respondents. By using density analysis in ArcGIS, it identified the concentration of photos captured places. The finding shows there are 7 clusters of landscape character captured by participants where each clusters has different trend locations of photos points' density. It shows a valuable input for planning and management of BKF related with attractive landscape views and elements with its trend locations. However, the most preferred landscape is still a question in this research. The next research of participant's travelling time is needed in order to investigate the most preferred landscape and its observation places in relation with observation time.

**Keywords**

*VEP; Landscape; Scenery; Preference; Forest; Tanjungpinang*

---

**1. Introduction**

The perception of beauty of a landscape among professional planners, managers and users is sometimes different (DeLucio & Mugica, 1994; Hofmann, Westermann, Kowarik, & Van der Meer, 2012). What landscape planners and managers think about interesting places and objects sometimes different with user preferences. Therefore the

---

\* Corresponding author. Tel.: +81-70-1445-9411.  
E-mail address: arifin\_hadi@ipb.ac.id



study about user preference toward landscape they perceive is important as input for le planning and management. There are various way to do research in assessing landscape preferences, however the preference assessments result attached to the site is a challenge. In this research, we tried to combine study about visitors' preference, visitors' photos and visitors' tracking to obtain the landscape character that visitors perceived and its locations or trend of locations. This research result is very important to plan the future eco-tourism activities in Bukit Kucing Forest in order to avoid inefficiency and error of development regarding to visitors perceptions and behavior.

The visitors' photos are become object investigated in this research. It became evidence of what people see on a site (Markwell, 1997) or witnessing an event on a site (Koliska & Roberts, 2015). It is assumed that what visitors captured on the site, are landscape or objects that visitors' attention into, whether it is good or bad impression. The research with visitors' photos as research objects is possible to be implemented since the use of smartphones with camera are common in Indonesian people daily life. This benefit of growth of technology become answer of the constraint of visitors-employed photography research at the past, that the research is constrained by the cost of providing camera to respondents (Brian Garrod, 2008; MacKay & Couldwell, 2004).

The geo-tagging and GPS technology are important for complementing digital photography into more valuable, These technologies that is used optimally by (Mizuuchi, Son, Kang, & Furuya, 2015; Sugimoto, 2011) to investigate people preference of a landscape they visited. This method is implemented in this research for obtaining photos from visitors. What make differences with those two research is the analysis of visitors' photos that in this research, a multivariate hierarchical cluster analysis is implemented in order to obtain the character of landscape that visitors perceived during walking on the Bukit Kucing Forest.

The Bukit kucing forest is selected as research site based on its location in the middle of Tanjungpinang city. The number of forest exist in the middle of cities in Indonesia is less because of rapid development. The Bukit Kucing forest is one of the protected areas exist in the middle of Tanjungpinang city that have important role to conserve become a habitat of various birds, insects and vegetation in the city. However the city government of Tanjungpinang have a plan to create educational and ecotourism in Bukit Kucing Forest in the future. Before the plan is executed on the site, the potential visitors' preference research is implemented as input for the ecotourism program. The objectives of the research are investigate potential visitors' preference of landscape of Bukit Kucing Forest, identifying the character of landscape that visitors attract into.

## **2. Material and Method**

The method is combining the participants tracking, photos geo-tagging and photo based preference. The participants tracking is implemented in order to analyze participants' behavior related to the existing features and landscape characters on the site. This result will be analyzed in the next peer review paper. In this paper, we tried to analyze the participants preference based on the photos they captured and analyzed photos locations by using photos' geo-tagging tools. The landscape character performed by each photos were clustered in order to identify the landscape character that participants perceived during site visit.

The participants' preferred landscape were recorded in the photos they captured, implementing the visitors-employed photography method that was introduced for the first time by Cherem on 1970's (Heyman, 2012; Oku & Fukamachi, 2006) . The photos that captured were used as evidence of the view of landscape that participants perceived on the site. The participants' camera or smartphones with camera are used to capture the preferred photos. Once participants walking on the site, the GPS logger were attached to participants' bags or trousers in order to record actual geo-positions of each participants. The time data of the photos captured were matched with GPS logger data in GeoSetter

software from Friedemann Schmidt. The geo-tagged photos then analyzed in ArcGIS in order to analyze the density of photos captured points on the site. In the other hand, the photos contents of each photos were tabulated and analyzed in JMP software from SAS in order to obtain the hierarchical cluster of the photos' contents that each cluster shows the character of landscape view that captured by participants.

The research was conducted in Bukit Kucing Forest, Tanjungpinang city, Riau Island Province, Indonesia. This forest is stated as protected areas managed by City Government of Tanjungpinang city since 1987. The total area of the forest is 54.4 hectare located in the middle of Tanjungpinang city. It is a semi-open forest surrounded by settlements, no fences and people can access for free from any entrances. Despite on ease of entering the forest, all people activities in the forest should be reported to forest guard. Visitors who are not surrounded citizens usually enter the forest from forest guards post entrance.

The participants are 68 university students who study in universities in Tanjungpinang city consist of 56 Students are from University of Maritime of Raja Haji Ali (Umrah University), 10 Students are from Sekolah Tinggi Ilmu Sosial dan Ilmu Politik (STISIPOL) Raja Haji Tanjungpinang and 2 Students are from Sekolah Tinggi Ilmu Ekonomi Pembangunan (STIEP) Tanjungpinang. This group of respondents selected because university students are assumed have appropriate knowledge to possess themselves as objectives evaluators of Bukit Kucing forest. They are mature enough to decide preferred landscape features and have independent opinion about preferred landscape.

The procedure to participants before they taking a walk following predetermined track is, "please captured the preferred landscape sceneries or landscape objects that you see on the site". The number of photos is not limited in order to get the natural response from each participant to the landscape or objects they see. It is also because the attractive places and features of the site were not predetermined yet by the Bukit Kucing Forest manager. The outcome of this research was expected by the manager in order to make the eco-tourism plan for Bukit Kucing Forest.

After participants got explanation about the research and what should they captured on the site, the participants started to walk following predetermined track guided by the forest guard. The track is a loop track with counter-clockwise direction, It is an effort to avoid participants lost because in the forest there is still no sign board and some of the track were not paved yet. After finish walking, the participants back to the staring points near the forest guard base camp in order to fulfill questionnaires, copy the photos file to researcher's laptop, give back the GPS logger and receive the survey fee for Rp. 50.000,-.

### **3. Result**

There were 1259 photos obtained from 61 participants. There were 7 participants that the photos cannot be geotagged due to the unavailability of metadata of time and date in their photos. Therefore the photos captured by 7 participants cannot be used in the ArcGIS analysis method in order to obtain its distribution and density. From the 1259 photos, it can be investigated that participants take pictures in almost every segment of track (Figure 1). The photos mostly captured in several stops before the peak area and decreased after the peak area. The track length is 2,700 m consist of 1,880 m paved track and 820 m non-paved track

The elements appear in each photo were then counted and tabulated its appearances. The data from analyzing each photos were analyzed in the multivariate hierarchical cluster analysis was implemented to the photos content. From the cluster analysis, it was stated 7 cluster of landscape elements that shows the character of landscape performed by each photos in each cluster.

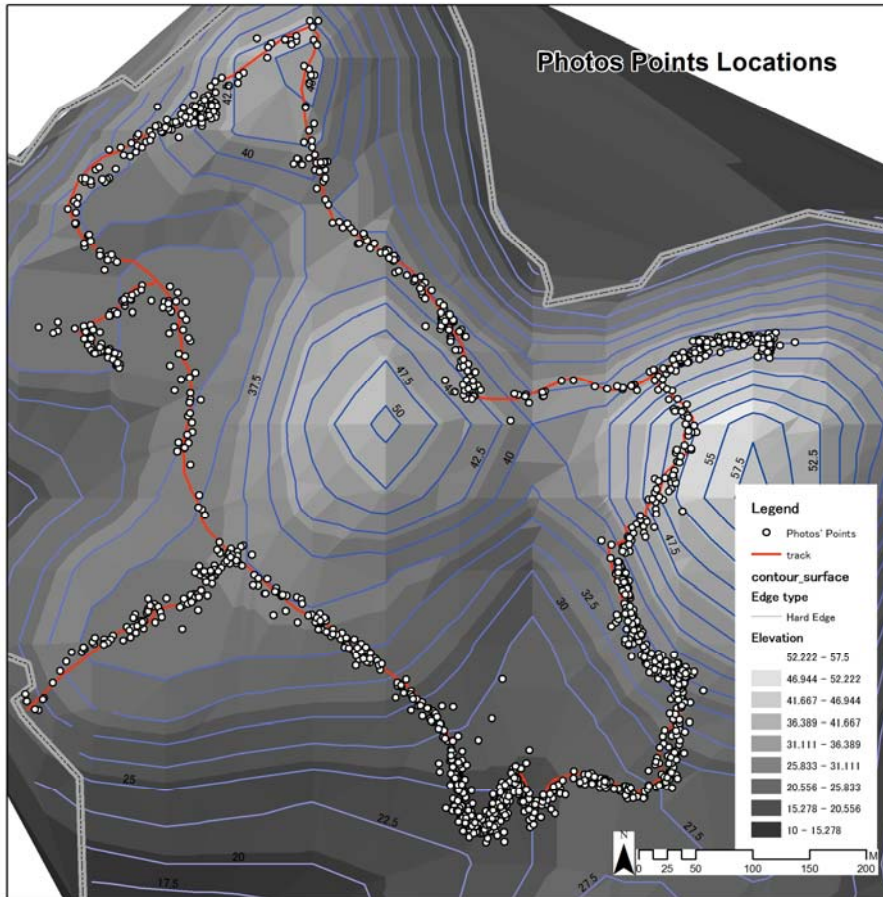

**Figure 1. Point location of Landscape Elements Captured by participants**

The cluster 1 consist of 470 photos (Table 1). The cluster 1 photos contents mostly consist of plants such as bushes (Mean: 0.785), trees (Mean: 0.583), grasses and weeds (Mean: 0.506) and ferns (Mean: 0.238) that were captured near the paved track. The small young trees (Mean: 0.157) and Melaleuca trees (Mean: 0.113) with dark color of bark sometimes appear in the photos of this cluster. The photos' captured points of this clusters mostly captured spread in the beginning of walking without specific concentration. It hotspot of photos' points density can be seen from the white spot along the tracks in Figure 3. It shows that the landscape with this character is often common in the half way of walking track.

The C1 is near with Cluster 2 (C2) which is consist of 208 photos (Table 1). Similar with C1, in the C2, the Trees (Mean: 0.918), bushes (Mean: 0.846), grasses and weeds (Mean: 0.716), drought trees (Mean: 0.74) and small young trees (Mean: 0.591) are often appear in the photos. However, the elements appearance that distinguish the photos of C1 and C2 is the increase number of appearance of sky (Mean: 0.918) that shows the photos mostly captured in open area, not look like in C1 that the sky usually hidden by trees canopies. The C2 photos mostly captured in grassland area which is performed by white spot in C2 points density (Figure 3). From this area, the other hilly areas in this forest mostly captured by participants. Due to the high density of C2 photos in the grassland area, the wide open of scenery that can be seen from this area is an interesting landscape character that worth to be optimized for recreation activities in this site.

The Cluster 3 (C3) and Cluster 4 (C4) are near relationship in the dendrogram (Figure 2). The C3 is characterized by high mean number of flowers (Mean: 0.309) and sky (Mean: 0.256) appear in the photos. In this cluster, participants more capture detail

object of plants, i.e. flowers. The sky that often appear shows that the flower captured in the photos mostly captured in open area or located on the trees branch upon human level so the camera direction is up-angel. Similar with C3, the photos in C4 are also consist of detailed object with close angel. However, the object captured in C4 are spiders animal (Mean: 0.750). However, the number of photos in C4 is less than other cluster because not all participants found animals and not all of them pay attention to animals while walking.

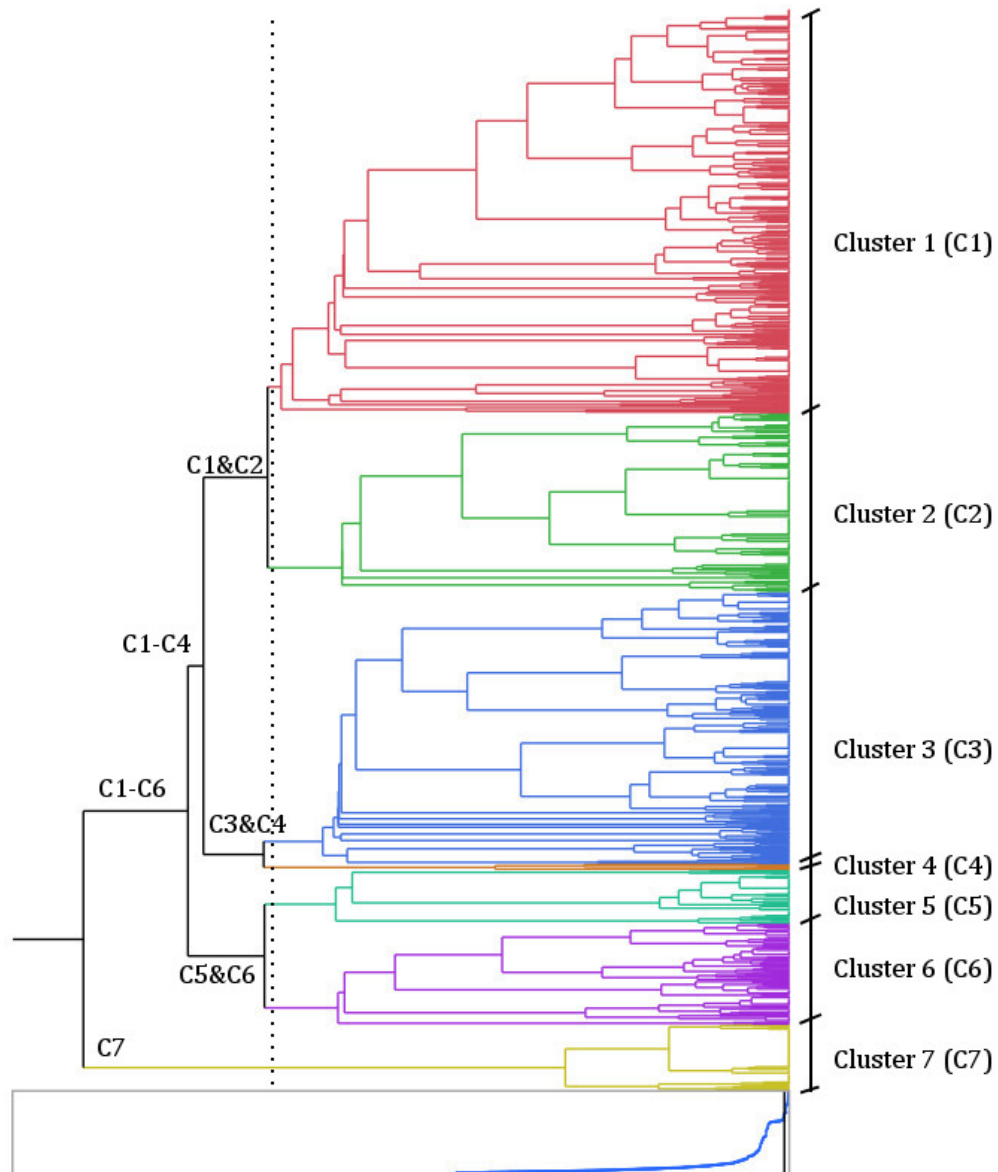
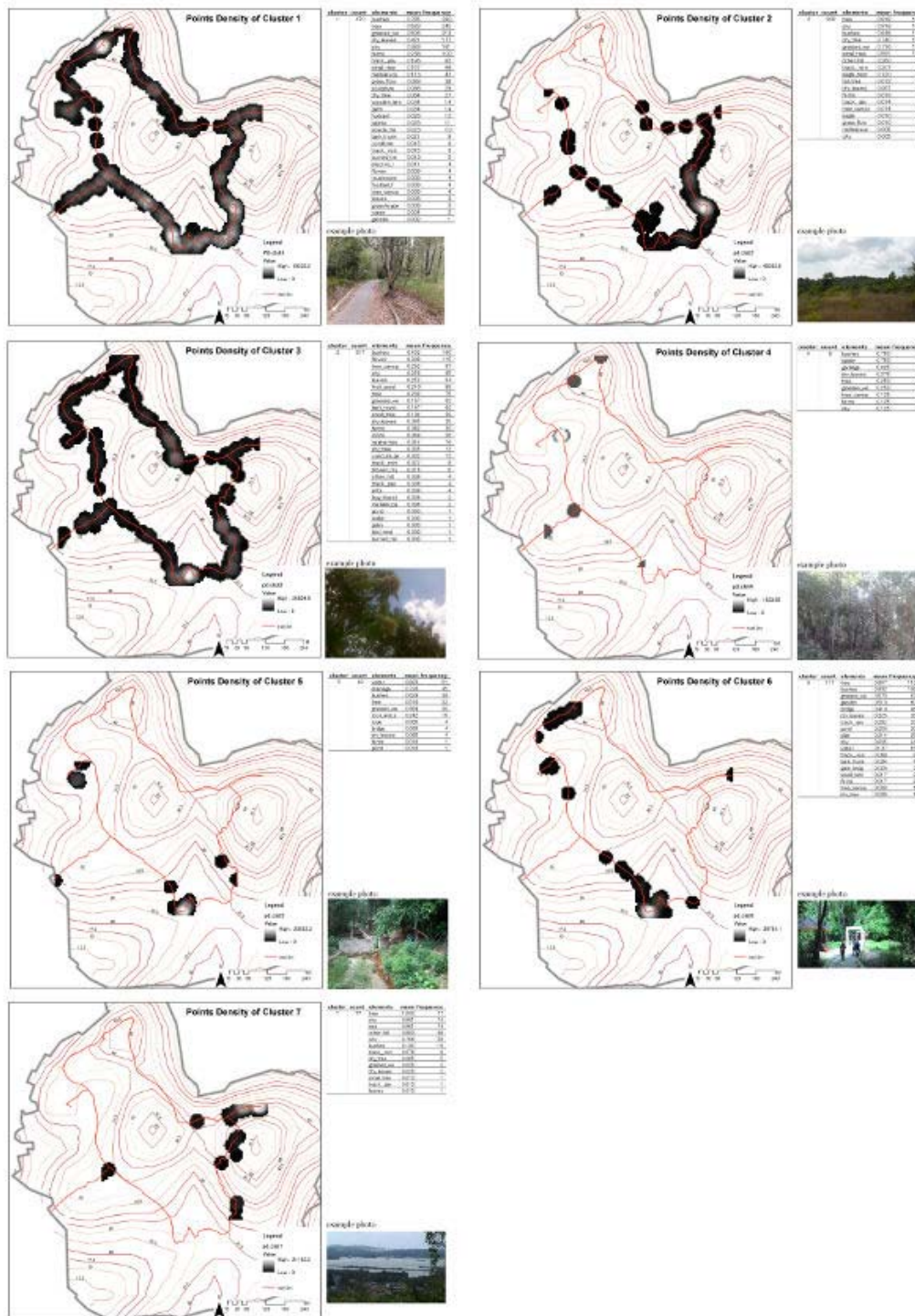

Figure 2. Hierarchical Cluster of landscape elements based on participants photos



**Figure 3. The Photos' location, Appearance of Landscape elements and example photos of Cluster 1 - 7**

The cluster 5 (C5) and Cluster 6 (C6) are near relationship in the dendrogram (Figure 2). They consist of photos of water-related features. The C5 consist of landscape with water (Mean: 0.823) such as at ditch-drainage corridor and “Batu menangis” rock sites (0.242). These landscape characters are perceived by participants while they do recreation on the BKF site. Different with C5, the photos of C6 are consist of photos of features surround the water and ditch-drainage corridor. It is not more to the waterbody because the water as object less appear in C5 but the trees (Mean: 0.957), bushes (Mean: 0.932) and grasses and weeds (Mean: 0.573) are often captured in this cluster. The unique

Table 1. The Landscape Elements Appear in Photos of Each Cluster

Cluster	Count	Elements	Mean	Frequency
1	470	Bushes	0.785	330
		Tree	0.583	245
		Grasses and weeds	0.506	213
		Dropped dry leaves	0.421	177
		Sky	0.383	161
		Ferns	0.238	100
		Paved Track	0.196	82
		Small young tree	0.157	66
		Mellaleuca tree	0.113	47
		2	208	Tree
Sky	0.918			191
Bushes	0.846			176
Drought trees	0.740			154
Grasses and weeds	0.716			149
Small young tree	0.591			123
Other hill on far	0.260			54
Non-Paved Track	0.207			43
Eagle nest	0.120			25
3	317			Bushes
		Flower	0.309	115
		Tree canopy	0.262	97
		Sky	0.256	95
		Leaves	0.252	94
		Fruit seed	0.240	89
		Tree	0.202	75
		Grasses and weeds	0.167	62
		Bark & trunk	0.167	62
		Small young tree	0.104	39
		Dropped dry leaves	0.095	35
		Ferns	0.082	30
		4	8	Bushes
Spider	0.750			6
Garbage	0.625			5
Dropped dry leaves	0.375			3
Tree	0.250			2
Grasses and weeds	0.250			2
Tree canopy	0.125			1
Ferns	0.125			1
Sky	0.125			1
5	62			Water
		Drainage	0.726	45
		Bushes	0.629	39
		Tree	0.516	32
		Grasses and weeds	0.484	30
		Rocks	0.242	15
		6	117	Tree
Bushes	0.932			109
Grasses and weeds	0.573			67
Gazebo	0.513			60

		Bridge	0.410	48
		Dropped dry leaves	0.325	38
		Paved Track	0.282	33
		Pond	0.256	30
		Pipe	0.214	25
		Sky	0.205	24
		Water	0.137	16
7	77	Tree	1.000	77
		Sky	0.961	74
		Sea	0.961	74
		Other hill on far	0.883	68
		City	0.766	59
		Bushes	0.130	10

elements appear in the C6 are gazebo (Mean: 0.513) and red-bridge (Mean: 0.41) located on the ditch-drainage corridor. They characterized the landscape that distinguish them with track corridors in C1.

The cluster C1 to C6 are consist of photos which are consist of objects or features inside the BKF site. They are located in one clade of clusters. Different with C1 to C6, the Cluster 7 (C7) consist of object outside of BKF site or it is called as borrowing view. The photos of C7 mostly consist of Tanjungpinang city (Mean: 0.766) and seashore side (Mean: 0.961) that can be seen from the peak of the hill in BKF site. The existing structure in this peak of hill is a gazebo that preferred by participants to stay as rest point and taking pictures. Therefore, according to the points density map, the photos of C7 mostly captured in this gazebo area.

#### 4. Discussion

The procedure to capture preferred landscape is a key of this research. However, the average number of preferred landscape photos by each participant is high with 21 photos per person. This number is high if it compare with other VEP studies, such as by (B. Garrod, 2008) with 8 photos per person, (Mizuuchi et al., 2015) with 16.46 photos per person and (MacKay & Couldwell, 2004) with 13 photos per person although it is still lower than (Sugimoto, 2011) who conduct the research with less number of participants. It shows that each participants has desire to capture landscape they preferred and it is statistically a good number of photos to be analyzed in cluster analysis and point's density analysis in this VEP research.

There are various existing features such as sceneries, elements and wildlife in BKF that need to be explored as ecotourism attraction. However, in this research, we tried to identify the attractive sceneries and elements that can be perceived by participants from predetermined tracks. The result above maybe different if participants allowed to decide the tracks that walk. The predetermine track was chosen considering there is no sufficient direction and tracks that guarantee the participants' safety during on-site observation.

In this research, the visual characters of attractive landscape and elements of BKF were identified by participants. The attractive landscape and elements were performed by 7 photo clusters based on participants' self-captured photos. In this research, participants judged preferred landscape views or objects by their self-representation about the site. Compare with other method of landscape preference studies by using researcher's prepared photos as research subject, this method give more opportunity for participants to explore more about view or objects they preferred. It is an effort to avoid misunderstanding between visitors, i.e. participants with landscape manager or planner about attractive landscape view or elements that can be explored more as tourism objects.

The photos of landscape view consist of composition of trees, bushes, grasses, weeds, dropped-dry leaves and ferns in C1 are the most number photos captured by participants. However, the high number of photos in this cluster did not mean that this view is preferred most by participants because of the distribution of the photos' points are located in almost all segments of track and less dense or concentration. It is also happened to the clusters which are consist of less number of photos but concentrated in one specific places, i.e. C5 which consist of water elements photos, C6 which consist of gazebo-bridge photos and C7 which consist of city scenery photos that maybe shows the truly participants' preferred views or objects but the number is lower than C1. This is the weakness of this research that participants did not asked about what is the photo that they preferred most due to the limited of research time and file transfer time on the site. However, this effort can be solved by analyzing the participants' time spent in each part of the site or track segments based on GPS logger data by assuming the more longer participants stay in a place, the more preferred landscape or object in that place. This analysis will be implemented in the next research.

## 5. Conclusion

The photos captured by participants are evidence of how participants perceive landscape view or elements in on-site observations. As a forest that has a plan to open for ecotourism activities, the photos points' density and photos contents are valuable input for landscape manager. It is related to the space and features that should be optimized in zoning phase. However, this research result should be continued with other types of participants in order to be more valuable for landscape management (Sugimoto, 2011).

Although the high cost of providing camera to participants in VEP research at the past (Brian Garrod, 2007; MacKay & Couldwell, 2004) had been resolved in this research by the use of participants camera, this research still has a constraint in budget to provide GPS logger for participants' tracking. In the future, the use of GPS logger has opportunity to be replaced by the growth of GPS technology in smartphone. However, until the research conducted, the geo-tagged location as metadata of photos which are captured by using smartphone with GPS function still have weakness in accuracy. Therefore the GPS logger is still needed in this research as supplement tool of providing actual participants' geo-location. Researcher also tried to use the tracking application in smartphones such as My Tracks application. However, this effort is constrained due to the privacy of participants' smartphones to install a program to their smartphones.

## Reference

- DeLucio, J. V., & Mugica, M. (1994). Landscape preferences and behaviour of visitors to Spanish national parks. *Landscape and Urban Planning*, 29(2-3), 145-160. [http://doi.org/10.1016/0169-2046\(94\)90024-8](http://doi.org/10.1016/0169-2046(94)90024-8)
- Garrod, B. (2007). A Snapshot into the Past: The Utility of Volunteer-Employed Photography in Planning and Managing Heritage Tourism. *Journal of Heritage Tourism*, 2(1), 14-35. <http://doi.org/10.2167/jht018.0>
- Garrod, B. (2008). Exploring place perception a photo-based analysis. *Annals of Tourism Research*, 35(2), 381-401. <http://doi.org/10.1016/j.annals.2007.09.004>
- Garrod, B. (2008). Understanding the Relationship between Tourism Destination Imagery and Tourist Photography. *Journal of Travel Research*, 47(3), 346-358. <http://doi.org/10.1177/0047287508322785>
- Heyman, E. (2012). Analysing recreational values and management effects in an urban forest with the visitor-employed photography method. *Urban Forestry and Urban Greening*, 11(3), 267-277. <http://doi.org/10.1016/j.ufug.2012.02.003>
- Hofmann, M., Westermann, J. R., Kowarik, I., & Van der Meer, E. (2012). Perceptions of parks and urban derelict land by landscape planners and residents. *Urban Forestry and Urban Greening*, 11(3), 303-312. <http://doi.org/10.1016/j.ufug.2012.04.001>



- Koliska, M., & Roberts, J. (2015). Selfies: Witnessing and Participatory Journalism with a Point of View. *International Journal of Communication*, 9, 1672–1685.
- MacKay, K. J., & Couldwell, C. M. (2004). Using Visitor-Employed Photography to Investigate Destination Image. *Journal of Travel Research*, 42(4), 390–396. <http://doi.org/10.1177/0047287504263035>
- Markwell, K. W. (1997). DIMENSIONS OF PHOTOGRAPHY A NATURE-BASED TOUR IN, 24(1), 131–155.
- Mizuuchi, Y., Son, Y., Kang, M., & Furuya, K. (2015). Constructing a Survey Method for Landscape Evaluation Using Visitor Employed Photography and GPS. *Landscape Research Japan Online*, 8(1), 1–7.
- Oku, H., & Fukamachi, K. (2006). The differences in scenic perception of forest visitors through their attributes and recreational activity. *Landscape and Urban Planning*, 75(1–2), 34–42. <http://doi.org/http://dx.doi.org/10.1016/j.landurbplan.2004.10.008>
- Sugimoto, K. (2011). Analysis of Scenic Perception and Its Spatial Tendency: Using Digital Cameras, GPS loggers, and GIS. *Procedia - Social and Behavioral Sciences*, 21, 43–52. <http://doi.org/10.1016/j.sbspro.2011.07.010>

---

## **Deformation Analysis of Merapi Volcano Using DInSAR Method on ALOS/PALSAR Image**

Dodi Sudiana<sup>a</sup>, Retno Wigajatri Purnamaningsih<sup>a</sup>, Sarah Az Zahra<sup>a</sup>, Bambang Setiadi<sup>b</sup>, Josaphat Tetuko Sri Sumantyo<sup>b</sup>

*<sup>a</sup>Department of Electrical Engineering, Faculty of Engineering, Universitas Indonesia, Kampus UI Depok 16424, Indonesia*

*<sup>b</sup>Josaphat Microwave Remote Sensing Laboratory, Center for Environmental Remote Sensing, Chiba University, 1-33 Yayoi-cho, Inage-ku, Chiba 263-8522, Japan*

---

### **Abstract**

Indonesia is a country that prone to natural disasters and based on its geological conditions, Indonesia is circled by the ring of fire. Natural disasters such as earthquake, flood and volcanoes (volcanic and tectonic) are often occur. Since there are 129 active volcanoes in Indonesia, it is necessary to monitor the activity of the volcano, especially during active volcanic period. But dangerous areas around the volcano causing major difficulties in monitoring and direct observation. Therefore, volcano monitoring using remote sensing technique is preferred. In this paper, we propose Differential Interferometry Synthetic Aperture Radar (DInSAR) method to detect vertical ground deformation of Mount Merapi before and after the eruption in 2010 using ALOS/PALSAR data. Analysis results showed that the deformation obtained from 26 October 2008 to 1 February 2010 is up to 0.230 meters. The deformation result from this analysis is useful to monitor volcanic activity and build mitigation plan in volcano disasters in the future.

### **Keywords**

Remote sensing, Land deformation, Merapi volcano, DInSAR, ALOS/PALSAR

---

### **1. Introduction**

Indonesia is a country that prone to natural disasters including volcanoes due to geological conditions that put Indonesia in the ring of fire. Located at the confluence of three major plates forming the Earth's crust, Indonesia has 129 active volcanoes, or around 13% of the world's volcanoes. Java Island is only 7% of Indonesia's land, but its dense population (about 70% of the total population) with 35 volcanoes, causes very large potential level of danger of volcanic eruptions (Pamungkas, A.M. et.al, 2014).

Mount Merapi (elevation 2,978 m) is a volcano located in Central Java (25 kilometers north of Yogyakarta) is one of active volcanoes in Indonesia. It erupts every 5–10 years and produces Plinian eruptions every century (Agustan, 2010)(Surono, et al., 2012). The area located in 7°32'30" S~110°26'30" E, where Magelang and Yogyakarta are the nearest large town (less than 30 km from the summit) (Voight, B., et.al, 2000). Because of the proximity region of Mount Merapi to inhabitant, it is important to do the observations and actions that can minimize the impact of volcanic eruptions (mitigation).

Merapi had three unrest periods during 3 years: 2007, 2008, and 2010. The first two were characterized by periodic lava dome growth, similar to Popocatepetl and Colima [Simkin and Siebert, 2002]. In 2010, defined as the century eruption, Merapi produced pyroclastic flows, ash plumes, and explosions between 26 October and 2 November 2010. This eruption resulted in the death of 400 people and the evacuation of ~400,000 (Chaussard, E., et al., 2013)(Pallister, J.S., et al., 2012).

One method of monitoring the volcanic activity is to monitor the land deformation in the volcano related to eruptions and other geological activities. These deformation observations can be used as mitigation because it is one indicator that can be trusted as the revival of volcanic activity. One effort in monitoring the volcanic activity is to monitor the surface deformation around the volcano. The volcano deformation can be caused by changes in pressure or movement of magma deep within the Earth (Pamungkas, A.M., et.al, 2014). In addition, analytical data derived from the deformation showed the rate of magma that go into the body of volcanic and magma's volume vomited in case of eruption. In this paper, we propose Mount Merapi volcanic deformation using ALOS/PALSAR satellite data analyzed using Differential Interferometry Synthetic Aperture Radar (DInSAR) technique and we map the rate of deformation before and after the Merapi volcano eruption in 2010. DInSAR technique has many advantages such as require less SAR imagery scenes by diverse spatial acquisition point, good level of coherence on the whole set of interferogram and measurement accuracy level up to centimeters.

## 2. DInSAR

Remote sensing is the science (and to some extent, art) of acquiring information about the Earth's surface without actually being in contact with it. This is done by sensing and recording reflected or emitted energy and processing, analyzing, and applying that information (CCRS, 2016). Although not necessarily, remote sensing techniques in practice often involve technologies such as aircrafts and satellites.

ALOS is a Japanese satellite that was fully equipped with technologies to observe the Earth's surface, which was launched by the Japan Aerospace Exploration Agency (JAXA) on January 24, 2006 (JAXA1, 2016). ALOS is supplied with PALSAR, a microwave's sensor for ground observation in all weather, day or night day with various resolutions. PALSAR operates with multiple polarization with a center frequency of 1270 MHz and a wavelength of 23.6 cm. The ability to combine the polarization mode of the horizontal (H) to vertical (V) makes both received and transmitted signals can be produced in dual polarization (HH, HV, VH, VV). Standard data generated by PALSAR sensor can be classified based on the manufacturing processes and modes of observation. Generally, the data is formatted in Level 1.0, Level 1.1 and Level 1.5 (JAXA2, 2016).

### 2.1. Synthetic Aperture Radar (SAR)

Synthetic Aperture Radar is a radar system that produces images of remote sensing which can operate day or night (active system). Basically, radar technology is applied to emit radio waves to an object and then the received reflection is recorded to create the data. Changes in the object could be analyzed when the radio waves are reflected and represented the Earth's surface changes.

SAR interferometry or InSAR is developed to get topographic maps of an area or topography for a given point on Earth's surface (Agustan, 2010). The product of this technique is the interferogram obtained from the cross product pixel by pixel from two SAR images (two SLCs) and a Digital Elevation Model (DEM) data that representing the topography of the Earth (Bürgmann, et al., 2000). The illustration of retrieving the topography of the Earth's surface using InSAR technique is shown in Fig. 1.

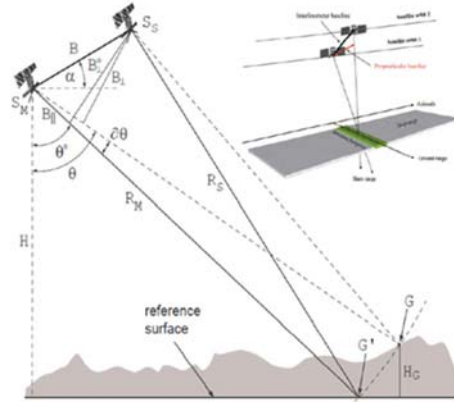

Figure 1. InSAR technique to retrieve the Earth's topography

To get the interferogram, two images are required: master and slave data, where master is generally the data being scanned beforehand and slave image is the following data. The interferogram contains amplitude which is the cross product of the amplitude of the two image, and the phase is a phase difference between the images. The formula of interferogram and phase are represented in Eq. (2) and Eq. (3), respectively.

$$\text{Interferogram} = y(\text{master}) * y(\text{slave}) \quad (1)$$

$$\text{Interferogram} = A_M A_S e^{i(\phi_M - \phi_S)} \quad (2)$$

$$\phi_G = \phi_M - \phi_S = \tan^{-1} \left( \frac{1}{R} \right) = - \frac{4\pi (R_M - R_S)}{\lambda} \quad (3)$$

where:  $\phi_G$  = Interferometric phase  
 $R_M - R_S$  = Distance between satellite and object  
 $\lambda$  = SAR wavelength

Since there are two different observation times, the orbit of the satellite on the two image is not exactly the same. The distance between the two positions of the satellite known as the baseline (B), and can be decomposed into parallel and perpendicular baseline, respectively. Based on geometry of InSAR illustration shown in Fig. 1, high point (G) of the surface of the Earth ( $H_G$ ) on the surface of a reference to the phase difference ( $\partial\phi$ ) can be defined by Eq. (4) and Eq. (5).

$$H_G = \frac{\lambda R_M \sin(\theta_G^0)}{4\pi B_{\perp,G}^0} \partial\phi \quad (4)$$

$$B_{\perp,G}^0 = B \cos(\theta_G^0 - \alpha) \quad (5)$$

where:  $\theta_G^0$  = Look angle point (G)  
 $\alpha$  = Baseline angle of the satellite

$\partial\phi$  can be replaced by  $2\pi$  to get high ambiguity ( $h_a$ ) which can be interpreted as a difference in altitude that produce interferometric phase change of  $2\pi$  after flattening the interferogram. High ambiguity is associated with the difference orbit between image and change of the same height will produce a single fringe  $h_a$  as expressed in Eq. (6).

$$h_a = \frac{\lambda R_M \sin(\theta_G^0)}{2B_{L,G}^0} \quad (6)$$

Fringe is a ring of color that has the same phase in the interferogram and depends on baseline parameters. Fringe on the interferogram is not directly represent height or altitude because the phase shown is still a relative one. Therefore, unwrapping process is necessary to obtain the absolute phase. In addition, the interferogram also contains a phase difference caused by unevenness and sources of decorrelation that occur between two observation times. Sources of decorrelation such as temperature, geometry center Doppler, time and volume, resulted in interpolation and coregistration errors.

## 2.2. Differential Interferometric Synthetic Aperture Radar (DInSAR)

Differential interferometry or DInSAR is used to compensate the effect of topography on an interferogram using a Digital Elevation Model (DEM). The technique is used to eliminate the contribution of the topography phase of the area studied. The product of interferometry is an image that is often referred to differential interferogram. This interferogram contains information regarding the phase change caused by deformation.

Interferometric phase contains topographic information from the topographic profile ( $\phi_{topo}$ ), the difference in orbital trajectory ( $\phi_{orb}$ ), deformation ( $\phi_{defo}$ ), atmosphere ( $\phi_{atm}$ ) and noise phase ( $\phi_{noise}$ ) and can be rewritten as Eq. (7).

$$\phi_G = \phi_{curv} + \phi_{topo} + \phi_{orb} + \phi_{defo} + \phi_{atm} + \phi_{noise} \quad (7)$$

Therefore, deformation associated with a shift in the Earth's surface point based InSAR technique can be estimated by eliminating other unwanted signals. For the detection of ground deformation, the Differential InSAR (DInSAR) is defined as the reduction phase of the topography of the interferogram. Phase topography can be obtained by simulating the DEM derived from topographic maps, survey, or from other satellite data such as the Shuttle Radar Topography Mission (SRTM). The DInSAR technique is also known as two-pass differential interferometry because it needs only two SAR images. The technique is performed by subtracting the original interferogram obtained from the two SAR images with the interferogram retrieved from DEM simulation.

## 2.3. Data and Image Processing

We used ALOS/PALSAR data in Mount Merapi and its surrounding districts in Yogyakarta Province in raw format (level 1.1) with single and dual polarization, respectively. Shuttle Radar Topography Mission (SRTM) DEM on Yogyakarta with grid resolution 90 m is used as DEM data (CGIAR-CSI, 2016). Table 1 showed the ALOS/PALSAR satellite data that are used in the research.

Table 1. ALOS/PALSAR satellite data used in the simulation

No.	Date	Level	Off Nadir Angle	Polarization	Status Data
1	26/10/2008	1.1	34.3	HH	Master
2	01/02/2011	1.1	34.3	HH+HV	Slave

The flow chart of ALOS/PALSAR data processing to generate a deformation map using DInSAR technique is shown in Fig. 2.

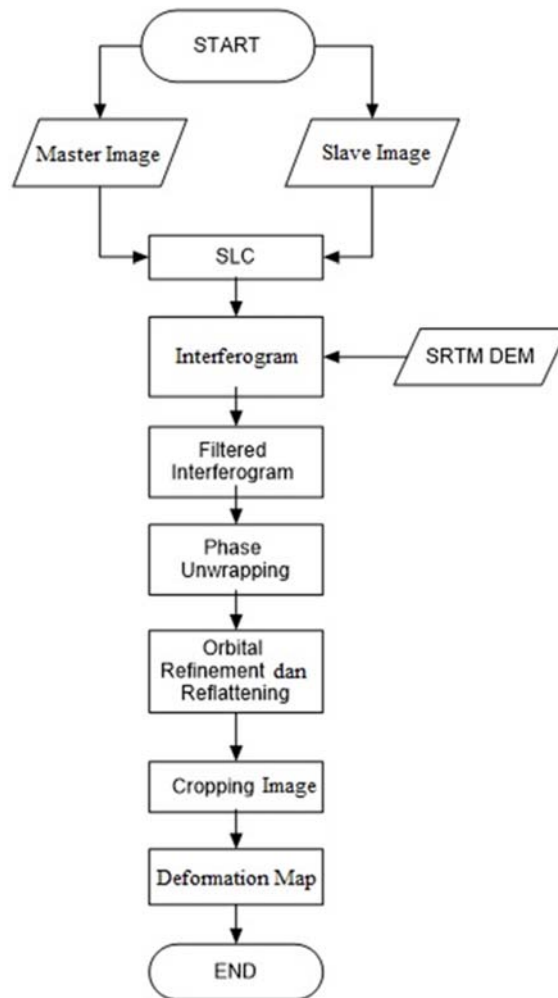
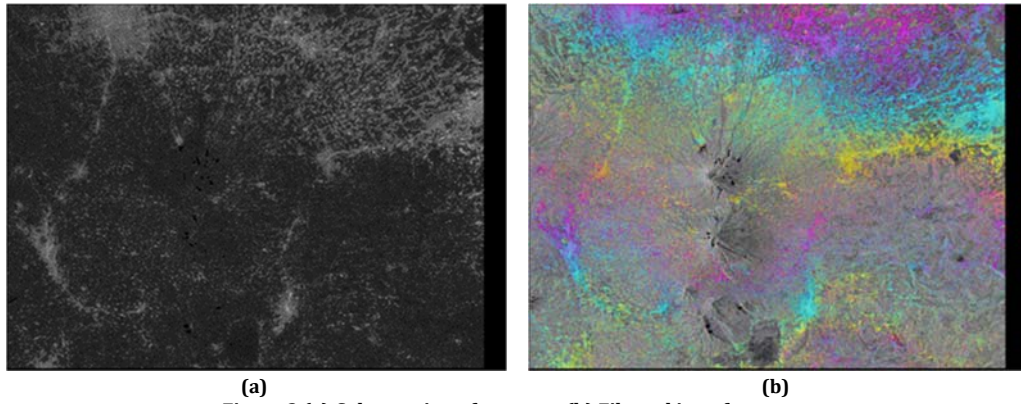

Figure 2. Flowchart of ALOS/PALSAR Data Processing for DInSAR Process

### 3. Analysis Results

Interferogram obtained from pixel by pixel cross product of master and slave SLC is then converted into DEM representing the topography of the Earth derived from the two SAR images. The filtering process is carried out to reduce noise in the image. Coherence values with below 0.2 are not considered for the next process as it will affect the quality of measurement of the interferometric phase. Coherence is the key product of InSAR, where areas with high coherence will give good estimates of altitude. The magnitude of coherence can be used to determine the quality of deformation information. This process is also performed to extract the information about the object on the surface related to varied backscattering coefficients. The results of these two processes are illustrated in Fig. 3(a) and 3(b), respectively.



(a) (b)  
 Figure 3.(a) Coherent interferogram; (b) Filtered interferogram

Interferogram which has been flattening give ambiguous terrain elevation cycle of  $2\pi$  of interferometric phase, therefore, phase unwrapping is applied. This process would eliminate ambiguous elevation values and adding multiple scaling of  $(2\pi)$  to the interferometric fringe. This process is aimed to make periodic phase can be calculated without being obstructed with cycle phase and the most important stage for lowering the DEM information since it determines the accuracy of the deformation information. The method of phase unwrapping in this step used the minimum cost flow with a local approach that unwrap a pixel based on the neighbor pixels and finally the result is shown in Fig. (4)

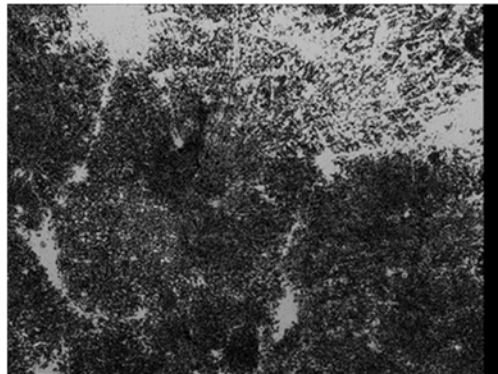

Figure 4. Result of Phase Unwrapping

Figure 5 showed the peak area of Mount Merapi that has a significant elevation difference with the surrounding area that has lower elevation.

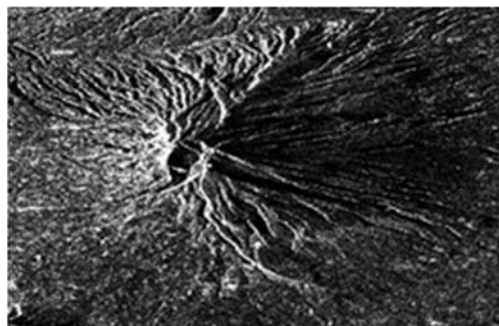

Figure 5. Phase unwrapped image after filtering

The next process is refinement and re flattening which aimed to eliminate two phases: topography and noise phases. It is necessary to choose Ground Control Points (GCPs) first as references for phase unwrapping and filtered interferograms. The GCPs must meet the following criteria:

1. GCP must lie on the residual orbital fringes
2. GCP should not be located on the topography or shift fringes
3. GCP should be located in areas with high coherence (bright area)
4. GCP should be distributed well in the area

Refinement and re flattening are very important steps for correcting the phase information that has been unwrapped or shifted before converted to height values. These two results are shown in Fig. 6(a) and Fig. 6(b), respectively.

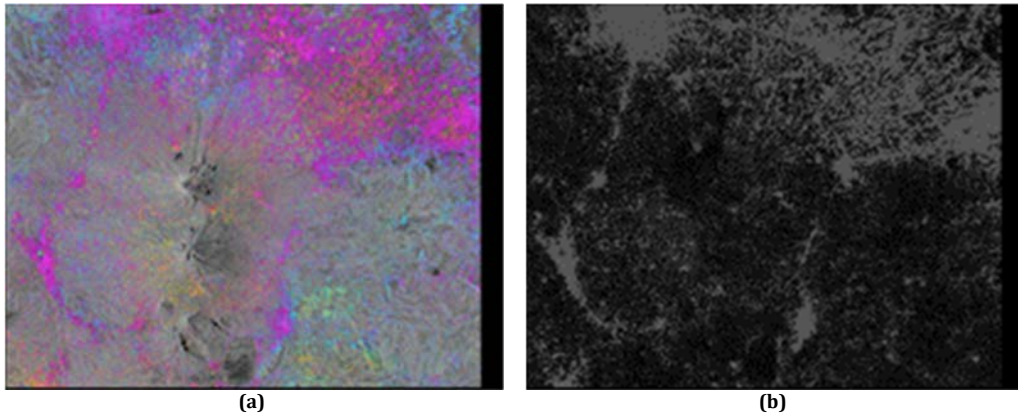

Figure 6. (a) Re-flattened interferogram; (b) Re-flattened unwrapped phase

The next process is converting the phase to the height/shift value and geocoding. The values of the absolute phase is calibrated and combined with the unwrapped phase of synthetic phase and converted into height profiles. The data is the geocoded and projected into a map projection. This step is almost the same as previous geocoding procedure, except that the Range-Doppler equation is applied simultaneously to the two antennas, making it possible to get not only the height of each pixel, but also the location (Easting, Northing) in the geodetic reference system as shown in Fig. 7.

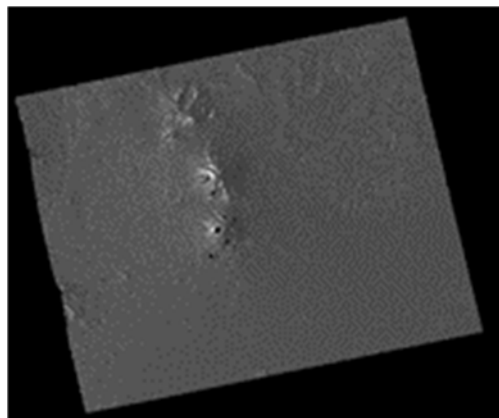
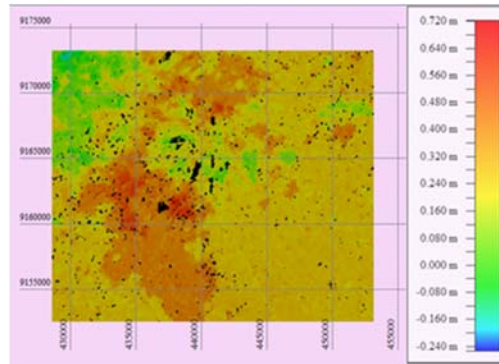

Figure 7. Result of conversion to height value

Mapping the interferometry is performed to generate Digital Elevation Model (DEM) data by radar interferometry. The shifting information is obtained by combining both SAR imageries. Information about the rate deformation of ground surface area on



Mount Merapi by using the ALOS/PALSAR data on October 20, 2008 (before eruption) and February 1, 2011 (after eruption) is shown in Fig. 8.



**Figure 8. Result of DInSAR Mt. Merapi land deformation**

As seen in Fig. 8, the rate of deformation is diverse and the area around the Mount Merapi is subsided as shown in green area, or negative values of land deformation in the figure. A negative value, or green to blue grades in the color scale means that the surface moving away from the satellite position, while yellow to red areas mean the positive deformation that the surface is moving toward the satellite position. We found that the land deformation reached about +0.320 meters that occur around the crater of the volcano, as seen as orange color from the image. While in the foot of the mountain, there is a negative deformation about -0.080 meters as marked in green area. This deformation caused by inflation which is generally caused by the pressure of magma in volcanoes pressed toward the surface of the Earth. This phenomenon happened not so long before the eruption of the Merapi. On the other hand, deflation occurred after the eruption where magma has been pressed towards the surface so that there are no longer objects to press on the volcano. Since the vacancy occurs on the volcano, the soil in the area is subsided at a certain level. The deformation result still contain noise in the form of black spots or holes in the image caused by the imperfect filtering results.

#### 4. Conclusions

The simulation results showed that the land deformation on Mount Merapi and its surroundings between 2008-2011 is about 0.320 meters in the area around the crater. But in the foot of the mountain there is a land subsidence up to -0.080 meters.

To increase the accuracy of the deformation level, DInSAR method should be improved using more accurate filters and increasing the number of image data to get a model active volcano deformation during the shorter period.

#### References

- Agustan (2010). Ground deformation detection based on ALOS-PALSAR data utilizing DInSAR technique in Indonesia, Dissertation, Nagoya University, Japan.
- Burgmann, R., et al. (2000). Synthetic Aperture Radar Interferometry to measure Earth's surface topography and its deformation. *Annu. Rev. Earth Planet. Sci.* 2000. 28:169-209
- CCRS, Canada Centre for Remote Sensing (2016). Fundamentals of Remote Sensing. <http://www.nrcan.gc.ca/earth-sciences/geomatics/satellite-imagery-air-photos/satellite-imagery-products/educational-resources/9363>. Last accessed 15 June 2016.
- CGIAR-CSI (2016). SRTM data selection options. <http://srtm.csi.cgiar.org/SELECTION/inputCoord.asp>. Last accessed 15 June 2016.
- Chaussard, E., et al. (2013). Characterization of open and closed volcanic systems in Indonesia and Mexico using InSAR time series. *J. of Geophysical Research: Solid Earth*, Vol. 118, pp. 3957-3969, doi:10.1002/jgrb.50288, 2013.
- JAXA1 (2016). About ALOS-PALSAR. <http://www.eorc.jaxa.jp/ALOS/en/about/palsar.htm>. Last accessed 15 June 2016.

- JAXA2 (2016). ALOS/PALSAR Level 1.1/1.5 product Format description. NEB-070062B. [http://www.eorc.jaxa.jp/ALOS/en/doc/fdata/PALSAR\\_x\\_Format\\_EL.pdf](http://www.eorc.jaxa.jp/ALOS/en/doc/fdata/PALSAR_x_Format_EL.pdf). Last accessed 15 June 2016.
- Pallister, J.S., et al. (2012). Merapi 2010 eruption—Chronology and extrusion rates monitored with satellite radar and used in eruption forecasting, *J. Volcanol. Geotherm. Res.*, 1-9, doi:10.1016/j.jvolgeores.2012.07.012.
- Pamungkas, A.M. et.al (2014). Monitoring of Merapi Volcano Deformation Using Interferometry Synthetic Aperture Radar (InSAR) Technique. *J. of Environment* Vol. 1, pp. 1-9.
- Simkin, T., and L. Siebert (2002). Global Volcanism Program. Smithsonian Institution, Global Volcanism Program Digital Information Series, GVP-5. <http://www.volcano.si.edu/education/questions/>. Last accessed Oct. 10, 2015
- Surono, J.P., et al. (2012). The 2010 explosive eruption of Java's Merapi volcano—A '100-year' event, *J. Volcanol. Geotherm. Res.*, 241-242(C), 121-135, doi:10.1016/j.jvolgeores.2012.06.018.
- Voight, B., et.al (2000). Historical eruptions of Merapi volcano, central Java, Indonesia, 1768-1998. *Journal of Volcanology and Geothermal Research*, 100, 69-138.

---

## **Analyzing Land Use and Land Cover using Combined Landsat 8 and ALOS-2/PALSAR-2 Data-Case Study: Bandung Regency**

Dodi Sudiana<sup>a</sup>, Retno Wigajatri Purnamaningsih<sup>a</sup>, Sulistyaningsih<sup>a</sup>, Bambang Setiadi<sup>b</sup>, Josaphat Tetuko Sri Sumantyo<sup>b</sup>

*<sup>a</sup>Department of Electrical Engineering, Faculty of Engineering, Universitas Indonesia, Kampus UI Depok 16424, Indonesia*

*<sup>b</sup>Josaphat Microwave Remote Sensing Laboratory, Center for Environmental Remote Sensing, Chiba University, 1-33 Yayoi-cho, Inage-ku, Chiba 263-8522, Japan*

---

### **Abstract**

Bandung regency is one of the biggest regency in Indonesia with large number of population and rapid utilization of land. Land cover monitoring is necessary to prevent any land misuses and natural disasters. A way to monitor land cover is to classify the land cover uses remote sensing technique. To achieve better accuracy level, we propose active and passive satellite data fusion to monitor the land cover changes during 2-year period. We combined active (ALOS-2/PALSAR-2) and passive (Landsat 8) satellite imageries using maximum likelihood to produce land cover changes with less atmospheric disruption. Maximum likelihood is a supervised classification method using reference (training sample) data and probability of a pixel to be clustered in a specific class. The use of joint processing data resulted in better accuracy (60%) comparing to ALOS-2/PALSAR-2 only (40%). Residential area, barren land, and paddy fields/plantations during 2-year period (2014 and 2016) are increasing by 16.35%, 54.47%, and 88.08%, respectively. While forest is decreased by 27.62% in the same period.

### **Keywords**

Remote Sensing, Land Use Land Cover, ALOS-2/PALSAR-2, Landsat 8, Maximum Likelihood

---

### **1. Introduction**

Bandung regency is one of the biggest regency in Java island. As the capital of West Java Province, it has 1,762.39 km<sup>2</sup> area with population of 3,5 Million. The large number of population ensures that land uses in this regency change dynamically every year. Badan Pusat Statistik (BPS) of West Java reported that paddy fields in Bandung regency is 34,803 Ha in 2014 and increased to 36,212 Ha in 2016 (BPS, 2015).

Natural resource utilizations in this regency, in fact is often excessive and violate the government's rules and can be harmful to the population themselves. For example, some people burnt forest to open new paddy fields or plantations, or built new houses in an area prone to flood and landslide. As reported by Bapedas Citarum (2011) forest areas in this regency were damaged by 9,280.31 Ha in 2008 and 7,123.74 Ha in 2009 (Bapedas, 2015). Therefore, land use monitoring is necessary to observe the changing of

environments by analyzing land use and land cover of the regency. It aimed to find out the people's activity and land uses as well as early warning system for disasters such as landslides.

There are several methods to monitor land use and land cover, but the most effective one is using remote sensing techniques. Remote sensing is the science (and to some extent, art) of acquiring information about the Earth's surface without actually being in contact with it. This is done by sensing and recording reflected or emitted energy and processing, analyzing, and applying that information (CCRS, 2016). In this study, we proposed maximum likelihood method to classify land use and land cover in Bandung regency from remote sensing satellite imageries. In general, this method is applied to cluster pixels into specific classes based on training samples. Comparing to other methods, the maximum likelihood has higher accuracy than other supervised or unsupervised classification since it uses reference data from an image which its pixels are already clustered in classes.

Satellite data of ALOS-2/PALSAR-2 combined with Landsat 8 image is used as input data. The imageries from these satellites are obtained from sensors that operate in different wavelengths so the ability to detect and classify objects can be improved. These two satellites are chosen to improve the quality of information. Landsat 8 as an optic sensor is good to recognize an object and easy to interpret but lack of information due to atmospheric disruption and clouds. ALOS-2/PALSAR2 as an active sensor, has the ability penetrate atmosphere (clouds) but is hard to interpret since the data representation is not recorded in visual mode. Joint processing of these satellites produces an image which is easy to interpret with comprehensive information (Lehmann, E., et al., 2012).

## **2. Satellite Data and Classification Method**

### *2.1. ALOS-2/PALSAR-2 and Landsat 8*

ALOS-2 is a satellite made by Japan Aerospace Exploration Agency (JAXA) and was launched on May 24, 2014. It is an active satellite that the sensors transmitted its own electromagnetic wave to detect objects in Earth surface and the backscattered signals are received by its receivers, so objects could be recorded day or night in any weather conditions. PALSAR-2 radiates microwave on L-band with 1.2 GHz frequency and 0.23 m wavelength that can be used to penetrate clouds, vegetation and to monitor glaciers. PALSAR-2 is used in cartography, regional observation, disaster monitoring, and resource survey (Suzuki, Y., 2014). The electromagnetic wave radiated from L-band also can be reflected by tree's branches, solid objects, and soil surfaces. PALSAR-2 has different resolutions based on its observation mode (JAXA1, 2015). The highest spatial resolution is 1 m using spotlight mode. In this study we used PALSAR-2 ScanSAR mode with 60-100 m resolution.

PALSAR-2 has some polarimetry choices that the satellite radiates or receives the electromagnetic wavelength, vertical (V) or horizontal (H). This polarimetry or polarization will affect the quality of image. If the image uses more polarimetry (maximal: quad polarimetry consists of HH+HV+VH+VV), then the image quality will be better (JAXA2, 2015). In this study, dual polarization (HH+HV) is used.

Landsat 8 is NASA's satellite and was launched on February 11, 2013. Landsat 8 is the newest version of Landsat Data Continuity Mission (LCDM). This satellite is a passive satellite which only receives electromagnetic wavelength reflected by the Earth's surface. Landsat 8 has two instruments: Observational Land Imager (OLI) dan Thermal Infrared Sensor (TIRS). These instruments operate in the same electromagnetic wavelength as the previous version of Landsat. This satellite has multispectral resolution collected by all bands except for Band 8 that records panchromatic resolution. Landsat 8 has better image quality by adding image pixel bits. OLI has 9 band (band 1-9), TIRS has 2 band (band 10-

11). Each band operates in different electromagnetic wavelength and has different function as well (NASA, 2015). In this research, we selected Landsat 8 Band 5 to detect and distinguish forest and non-forest, vegetation, soil, and water.

## 2.2. Maximum Likelihood

We performed maximum likelihood, a supervised classification that the algorithm needs human's role to define desirable classes as well as the references (training sample) to represent each class. Human or the operator can define the rules that should be fulfilled to produce pixels from each class probability. It assumes that statistic value for each class in each channel distributed normally and the probability of each pixel is clustered in a specific class (Hogg, R.V. and Craig, A.T., 2015). The classification in maximum likelihood is based on training samples, i.e. pixel values that already recognized as a part of a class. Training samples selection should be well performed so it can optimize the classification process and resulting in high accuracy (Marini, Y., 2014).

Maximum likelihood is useful for low or mid resolution image and is suitable for this research. The probability of a pixel clustered in a specific class can be expressed in Eq. (1).

$$P(i|X) = \frac{P(X|i)P(i)}{P(X)} \quad (1)$$

With:

- $P(i|X)$  = Conditional probability from class  $i$  (Likelihood)
- $P(X|i)$  = Conditional probability from vector  $X$
- $P(i)$  = Probability class  $i$  occurs in image
- $P(X)$  = Probability from vector  $X$

Bayesian probability function is counted from each input of each class made by samples. Each pixel will determine the class with highest probability. Parameter value which maximize the probability is called Maximum Likelihood Estimation (MLE). For example  $X_1, X_2, X_3, \dots, X_n$  are random samples from distribution  $N(\theta, \sigma^2)$  with  $-\infty < \theta < \infty$ ,  $\theta$  is MLE, then the MLE can be expressed by Eq. (2)-Eq. (5)

$$L(\theta; x_1, x_2, x_3, \dots, x_n) = \left(\frac{1}{\sqrt{2\pi\sigma}}\right)^n \exp\left[-\sum_{i=1}^n \frac{(x_i - \theta)^2}{2\sigma^2}\right] \quad (2)$$

$$\ln L(\theta; x_1, x_2, x_3, \dots, x_n) = n \ln\left(\frac{1}{\sqrt{2\pi\sigma}}\right) + \left[-\sum_{i=1}^n \frac{(x_i - \theta)^2}{2\sigma^2}\right] \quad (3)$$

$$\frac{\partial L(\theta; x_1, x_2, x_3, \dots, x_n)}{\partial \theta} = 0 + 2 \sum_{i=1}^n (x_i - \theta) \quad (4)$$

$$\sum_{i=1}^n x_i - n\theta = 0 \rightarrow \theta = \frac{\sum_{i=1}^n x_i}{n} \quad (5)$$

So,  $\frac{\sum_{i=1}^n x_i}{n}$  is  $\theta$ 's value which maximize likelihood value  $L(\theta)$ .  $\theta = \frac{\sum_{i=1}^n x_i}{n}$  is called maximum likelihood estimator for  $\theta$ . The illustration for class selection in this method is shown in Fig. 1.

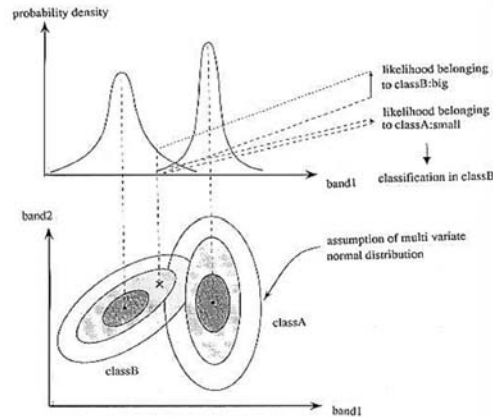

Figure 1. Illustration of Classification concept in maximum likelihood method

### 2.3. Pre-processing and Classification Plan

The pre- and processing of ALOS/PALSAR-2 data is diagrammatically shown in Fig.

2. Pre-processing is performed by the following steps:

1. Geometric correction consists of geocoding correction and image to image calibration method by collection ground control points (GCP) that Landsat 8 image is used as reference. The purpose of this process is to convert image's coordinate to the real coordinate in the Earth. Image resolution is resampled to 30 m resolution in the geocoding process using Digital Elevation Model (DEM) image.
2. Layover/shadow masking. This process is aimed to decrease layover and shadow effects in the image. Layover effect is a condition where the information received in the satellite are mixed caused by differences in arrival time of lowland's wavelength reflection and highland (plateau)'s wavelength reflection. Shadow is an effect where there is no backscatter or wavelength reflection received by the satellite since the coverage of highlands to lowlands.
3. In the speckle filtering, Lee filter is applied that is aimed to reduce the speckles effect (noise) in the image.
4. Radar section calculation is a process to produce image in dB values.

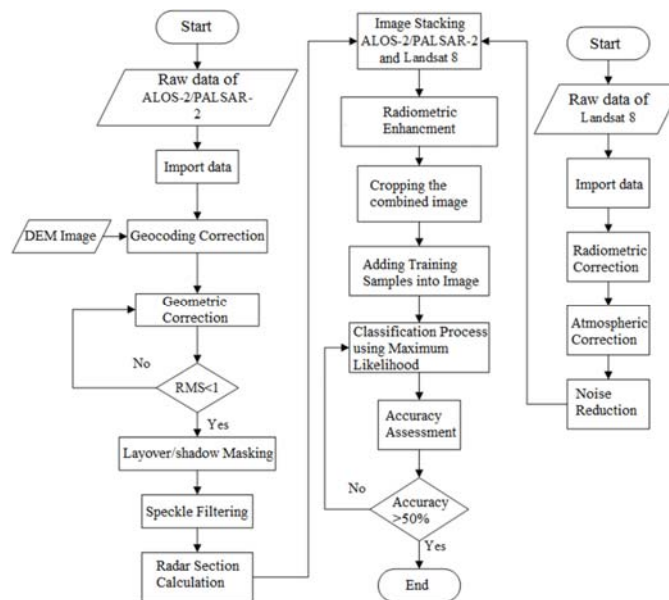

Figure 2. Flow diagram of Classification Process

The specification of Landsat 8 and ALOS-2/PALSAR-2 imageries that are used in this study is shown in Table 1.

Table 1. Specification of Landsat 8 and ALOS-2/PALSAR-2 image

No.	Monitoring date	Sensor	Polarization	Satellite type	Data Level
1.	December 12, 2014	PALSAR-2	HH, HV	Active, Non-Optical	1.1
2.	February 25, 2016	PALSAR-2	HH, HV	Active, Non-Optical	1.1
3.	December 11, 2014	Landsat	-	Passive-Optical	-
4.	January 15, 2016	Landsat	-	Passive-Optical	-

The pre-processing of Landsat 8 image is performed by the following steps:

1. Radiometric correction is aimed to correct pixels' value that are not fit with the real wavelength of reflected values. We applied the FLAASH algorithm in this process.
2. Atmospheric correction is aimed to reduce or to get rid of atmospheric disruption such as cloud.
3. Noise Reduction is aimed to reduce noise in the image using MNF algorithm.

The study area is Bandung regency that covers Bandung city, Cileunyi, and Ciparay districts as shown in Fig. 3.



Figure 3. Study area (Google, 2015)

### 3. Implementation and Classification Results

#### 3.1. Radiometric Enhancement

Landsat 8 and ALOS-2/PALSAR-2 imageries are combined or stacked to produce an RGB image. ALOS-2/PALSAR-2 HH polarization image, HV polarization image, and Landsat 8 band 5 (near-infrared band) image are selected as Red, Green, Blue bands, respectively. Band 5 of Landsat 8 is used to detect and to distinguish land cover such as forest and non-forest, soil, and water. Radiometric process is performed after image stacking to increase the pixels' intensity using piecewise linear algorithm as shown in Fig. 4.

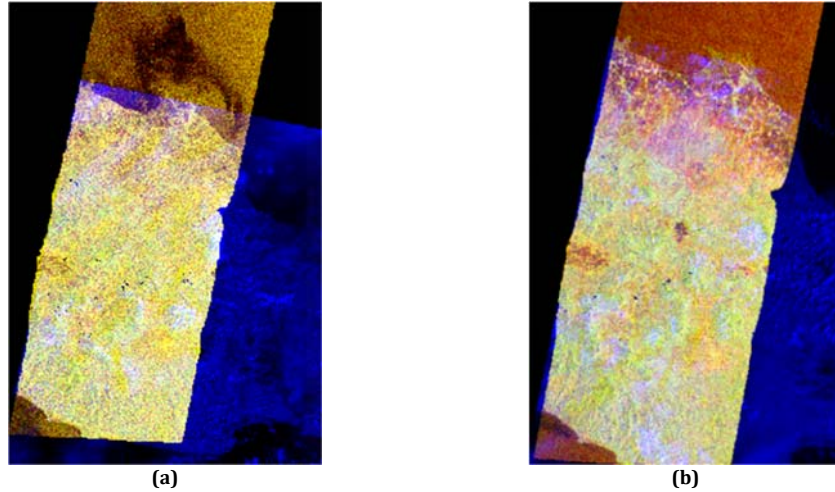

Figure 4. Combined image of (a) ALOS-2/PALSAR-2 on December 12, 2014 and Landsat 8 December 11, 2014  
 (b) ALOS-2/PALSAR-2 February 25, 2016 and Landsat 8 January 15, 2016

Since the large scene of both Landsat 8 and ALOS-2/PALSAR-2, to give more detail information on the study area, the imageries are cropped to Bandung regency only as shown in Fig. 5.

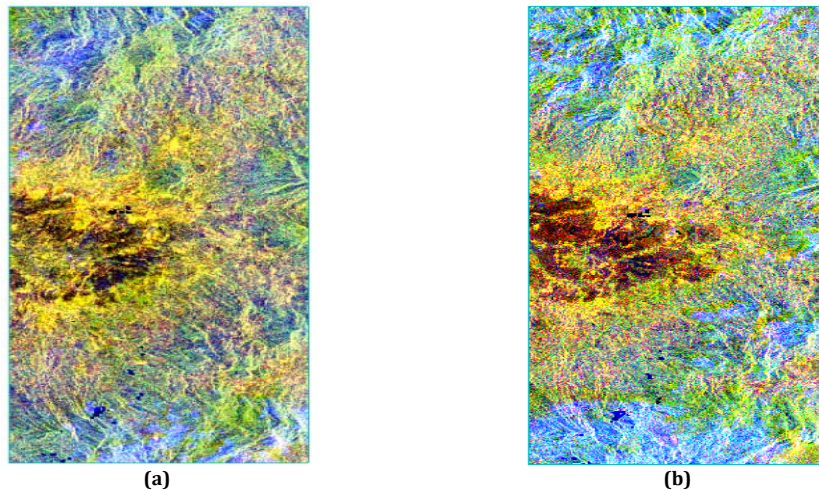

Figure 5. Cropped image of (a) ALOS-2/PALSAR-2 on Dec. 12, 2014 and Landsat 8 Dec. 11, 2014 image; (b) ALOS-2/PALSAR-2 on Feb. 25, 2016 and Landsat on Jan. 15, 2016

We selected training samples known as Region Of Interests (ROIs) based on Google Earth (Google, 2015). Training samples of ROI are then converted into .shp (vector) files and re-projected into UTM Zone 49S to match to the area. There are four classes of land cover: forest, barren land (in this study barren land consists of unused land and paddy fields that currently are not in planting or harvesting period), residential areas, and paddy fields/plantations. Training samples are selected according to the dates of satellite data: December 12, 2014 and February 25, 2016. We selected 100 ROIs as training samples for each classification class and divided into two parts: 50 ROIs are used for classification process and the other 50 are used for accuracy assessment.

### 3.2. Maximum Likelihood Method Implementation

In the classification, we used threshold value, the minimal probability value for a pixel to be clustered in a specific class. The threshold value used in this study is 0.05 for each class for all trials. As a result of this selection, some pixels will not be filtered into a specific



class (unclassified). These unfiltered pixels mean the areas related to these pixels represent land cover other than forest, barren land, residential areas, or paddy fields/plantations. We implemented ten simulations using different ROIs for classification process and accuracy assessment and the result is shown in Fig. 6.

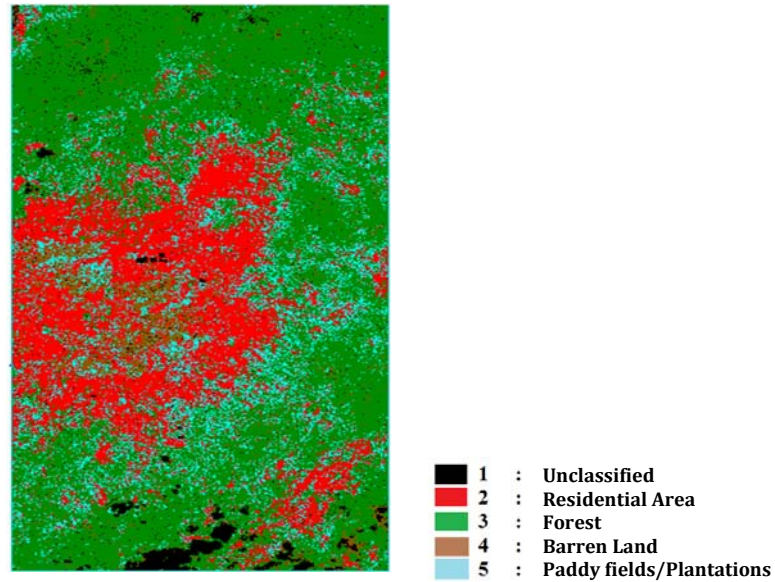

Figure 6. Classification result of joint processing of Landsat 8 December 11, 2014 and ALOS-2/PALSAR-2 December 12, 2014 combined image (first simulation)

Based on 10 classification results, the area for each class is presented in more detail in Table 2. As shown in the table, in 2014 most of the area classified as forest, followed by residential area, paddy fields/plantations, and barren land.

Table 2. Classification results of combined Landsat 8 on Dec. 11, 2014 and ALOS-2/PALSAR-2 on Dec. 12, 2014

Simulation	Area (Ha)			
	Residential Area	Forest	Barren Land	Paddy Fields/Plantations
1	20,147.67	43,275.33	4,636.80	10,734.66
2	18,543.33	43,762.23	7,429.95	9,059.49
3	19,258.47	45,551.34	3,650.13	10,326.33
4	19,091.07	44,812.26	6,269.49	8,695.26
5	20,151.63	42,244.74	3,677.13	12,712.77
6	19,556.55	44,274.60	6,494.04	8,677.44
7	20,709.27	43,249.14	4,411.17	10,374.39
8	20,061.45	43,642.17	7,181.28	7,858.71
9	19,056.96	46,978.65	5,827.32	6,725.07
10	20,323.89	39,441.78	4,748.94	14,256.99
Average	19,690.03	43,723.22	5,432.63	9,942.11

We implemented the classification method using the data in 2016. The Landsat 8 data was dated on January 15, 2016 and ALOS-2/PALSAR-2 was dated on February 25, 2016. The date of both data was different since the limited number of good quality of Landsat data. The first simulation using 50 ROI as training samples and 50 ROIs as testing data is shown in Fig. 7.

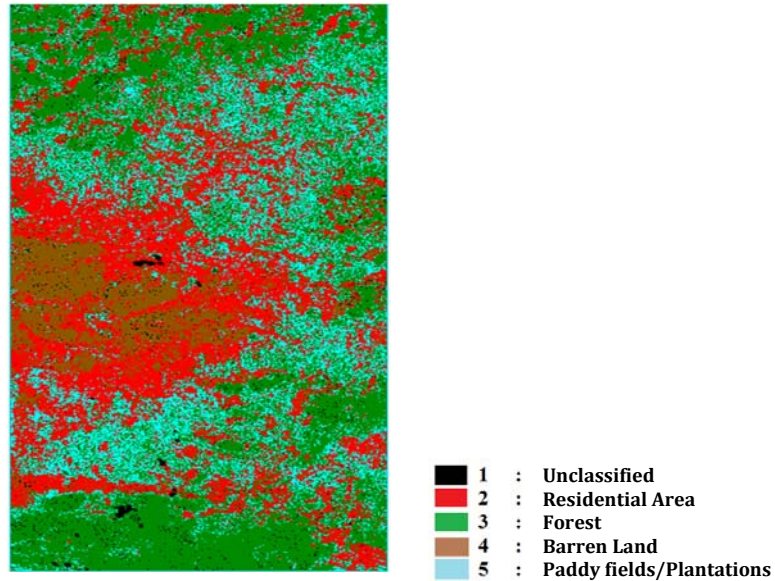

Figure 7. Classification result of joint processing of Landsat 8 January 15, 2016 and ALOS-2/PALSAR-2 February 25, 2016 (first simulation)

The overall simulation results, represented as the area for each class is shown in more detail in Table 3. As shown in the table, the composition of each class in 2016 almost the same with the 2014 case. Most of the area classified as forest, followed by residential area, paddy fields/plantations, and barren land.

Table 3. Classified area from combined Landsat Jan. 15, 2016 and PALSAR-2 Feb. 25, 2016

Simulation	Area (Ha)			
	Residential Area	Forest	Barren Land	Paddy Fields/Plantations
1	23,670.90	31,406.04	9,609.75	16,820.28
2	22,727.52	32,188.77	7,271.64	19,657.26
3	22,817.07	31,965.75	9,537.84	17,321.13
4	23,613.48	31,652.10	7,390.71	19,201.86
5	21,481.74	34,180.65	7,810.56	18,206.10
6	24,905.16	29,056.86	7,109.28	20,718.99
7	23,673.60	32,332.05	7,849.26	17,928.90
8	22,143.06	32,602.32	8,685.54	18,275.04
9	23,736.96	31,058.40	8,734.14	17,602.20
10	20,330.01	30,012.84	9,920.52	21,262.68
Average	22,909.95	31,645.58	8,391.92	18,699.44

### 3.3. Analysis of Classification Result

We assessed the accuracy of classification results using confusion matrix method. Confusion matrix is performed by comparing the classification result using 50 ROIs that are randomly selected to other 50 ROIs from the training sample for each class. The results of accuracy assessment of combined Landsat 8 and PALSAR-2 in 2014 and 2016 are shown in Table 4.

Table 4. Accuracy rate of classified image in 2014 and 2016

Trial	2014	2016
1	64.13%	60.16%
2	65.18%	61.05%
3	70.93%	60.99%
4	61.93%	60.54%
5	70.04%	67.16%
6	73.97%	60.15%
7	65.8%	60.21%
8	64.14%	64.91%
9	65.71%	63.23%
10	64.12%	62.34%
Average	66.60%	62.07%

The accuracy rate for classified Landsat 8 on December 11, 2014 and ALOS-2/PALSAR-2 on December 12, 2014 combined image is 66.60% and is higher than the accuracy of ALOS-2/PALSAR-2 image classification without Landsat 8 (41.42%). The classified image showed that forest (represented by green pixels) dominates the study area. Barren Land and residential areas are located in the center of Bandung regency. Barren land as well as paddy fields/plantations dominate the residential areas.

The accuracy rate for classified Landsat 8 on January 15, 2016 and ALOS-2/PALSAR-2 on February 25, 2016 combined image is 62.07% and is higher than the accuracy of ALOS-2/PALSAR-2 image classified without Landsat 8 (41.00%). The classified image shows that paddy fields and plantations (represented by light blue pixels) dominates the study area. As in 2014, the residential area in 2016 is increasing as shown by red pixels as well as barren land and paddy fields/plantations. The results are also correlated to the fact, that the number of population in Bandung is also increasing.

Paddy fields and plantations areas are increasing because barren land that is actually paddy fields and plantation areas that were not in planting or harvesting period in December 2014 entered harvesting period in February 2016, so paddy or other crops are dominant. As reported in Gala Daily (December 29, 2014), in the end of December 2014, Bandung regency is just entering planting period. Another news agency also reported as Kompas Daily on December 19, 2015 and West Java Province Agriculture authority stated that harvesting period will be in that February 2016 (Disdag, 2015). The comparison of each class in 2014 and 2016 based on the classification results is shown in Table 5.

Table 5. The comparison of area from each class based on classified results

Class	Area (Ha)		
	2014	2016	Difference
Residential area	19.690,03	22.909,95	3.219,92
Forest	43.723,22	31.645,58	-12.077,64
Barren land	5.432,63	8.391,92	2.959,29
Paddy fields/plantations	9.942,11	18.699,44	8.757,33

As shown in the table, all classes are increased during 2-year period, except the forest, that are decreasing by -12,077.64 Ha (-38.17%). The increasing area of paddy fields/plantations is also reported by West Java statistic data released by BPS (Badan Pusat Statistik). It stated that the area of paddy fields in Bandung regency is increasing

form 34,803 Ha in 2014 to 36,212 Ha in 2016. Referred to this study, paddy fields/plantations area is increased by 8,757.33 Ha.

The probability error that occurred during the classification process is caused by the pixels from a specific class is classified to different classes. In this case, PALSAR-2 as a radar sensor, recorded backscattered signals from the different classes into the same values. For example, paddy fields/plantations and forest pixels are recorded as similar class because both objects consist of vegetation. Another reasons that may occurred in the process are:

1. ALOS-2/PALSAR-2 and Landsat 8 images has a time difference so that the types of land cover can change during these dates period.
2. The noise in Landsat 8 image caused by cloud or other atmospheric disruptions.
3. The selection of training samples using Google Earth is not quite precise to determine the classes in classification process.

#### 4. Conclusions

The accuracy rate of land use and land cover classification using joint data from Landsat 8 and ALOS-2/PALSAR-2 is 66.60% (in 2014) and 62.07% (in 2016). The classification accuracy rate of joint data is increased by 60.78% and 51.40%, in 2014 and 2016, respectively, compared to classification using ALOS-2/PALSAR-2 only. Residential areas are increasing by 16.35% from 19,690.03 Ha in 2014 to 22,909.95 Ha in 2016. While forest areas are decreasing by 27.62% from 43,723.22 Ha in 2014 to 31,465.58 Ha in 2016. Barren land is increasing by 54.47% from 5,432.63 Ha in 2014 to 8,391.92 Ha in 2016. Paddy fields/plantations area is increasing by 88.08% from 9,942.11 Ha in 2014 to 18,699.44 Ha in 2016.

#### References

- Bapedas (2015). Badan Pengelolaan DAS Citarum Ciliwung. <https://bpdasctw.wordpress.com/>. Last accessed 15 October 2015.
- BPS (2015). Badan Pusat Statistik Provinsi Jawa Barat. <http://jabar.bps.go.id/>. Last accessed 12 October 2015.
- CCRS (2016). Canada Centre for Remote Sensing, Fundamentals of Remote Sensing. <http://www.nrcan.gc.ca/earth-sciences/geomatics/satellite-imagery-air-photos/satellite-imagery-products/educational-resources/9363>. Last accessed 15 June 2016.
- Disdag (2015). Dinas Pertanian Tanaman Pangan Provinsi Jawa Barat. <http://dagang.disperindag1.jabarprov.go.id/>. Last accessed 15 December 2015.
- Google (2015). Google Earth. <https://www.google.com/earth/>. Last accessed 20 October 2015.
- Hogg, R.V. and Craig A.T. (2015). Introduction to Mathematical Statistics, 5th Ed., 1995, Hongkong & Macau: Pearson Education Asia Limited & Higher Education Press. <https://www.scribd.com/document/52880907/Teori-Peluang-Bab-9>. Last accessed 2 November 2015.
- JAXA1 (2015). Advanced Land Observing Satellite-2 DAICHI-2 (ALOS-2). <http://alos-2-restec.jp/en/staticpages/index.php/abt-000>. Last Accessed 20 October 2015.
- JAXA2 (2015). ALOS-2 (Advanced Land Observing Satellite-2; SAR Mission)/Daichi-2. <http://directory.eoportal.org/web/eoportal/satellite-missions/a/alos-2>. Last accessed 20 October 2015.
- Lehmann, E., et al. (2012), Joint processing of landsat and ALOS-PALSAR data for forest mapping and monitoring. IEEE Transactions on Geoscience and Remote Sensing 50(1):55-67 · January 2012
- NASA (2015). Landsat Science. [http://landsat.gsfc.nasa.gov/?page\\_id=4071](http://landsat.gsfc.nasa.gov/?page_id=4071). Last accessed 10 October 2015.
- Suzuki, Y. (2014). New Era of Global Monitoring by ALOS-2: Advanced Land Observing Satellite-2 DAICHI-2, Int. Relations and Res. Dep., JAXA.

---

**Geological Mapping for the Land Deformation Using Small UAV,  
DInSAR Analysis and Field Observation at The Siak Bridge I and  
II, Pekanbaru City, Indonesia**

Husnul Kausarian<sup>a,b,\*</sup>, Josaphat Tetuko Sri Sumantyo<sup>a</sup>, Detri Karya<sup>b</sup>, Dewandra Bagus Eka Putra<sup>b</sup>, Evizal Abdul Kadir<sup>b</sup>

*<sup>a</sup>Josaphat Microwave Remote Sensing Laboratory, Center for Environmental Remote Sensing, Graduate School of Advance Integration Science, Chiba University, 1-33, Yayoi, Inage, Chiba, 263-8522, Japan*

*<sup>b</sup>Faculty of Engineering, Universitas Islam Riau, Jl. Kaharuddin Nasution No. 113 Pekanbaru Riau 28284, Indonesia*

---

**Abstract**

Pekanbaru is the capital city of Riau province, located in the center of the Sumatra Island Indonesia is experiencing rapid economic progress. The city is split by Siak river. Big bridges that connect this city are Siak I Bridge and Siak II Bridge. The Quality of Siak bridges paid attention seriously in this previous time, especially for Siak I bridge deflection, despite completely built from past time. Also for Siak II Bridge it needs more attention incase of this bridge is the road for the heavy truck way. Geological mapping using a small UAV conducted to determine the deformation points on the site of Siak I bridge and Siak II Bridge areas, the study of Siak I Bridge and Siak II Bridge are also supported by the DInSAR analysis using ALOS PALSAR data of Pekanbaru city and Deflection observation that occurs in Siak I bridge and Siak II Bridge was measured during field observation. Results of small UAV 3D models analysis shows no negative land deformation on the Siak I Bridge and Siak II Bridge areas. DInSAR analysis shows the number of positive deformation of Siak I Bridge is 81 cm and Siak II Bridge is 48 cm. Deflection on Siak I Bridge was detected around 10-15 cm.

**Keywords**

*Keywords:* Pekanbaru city; Siak Bridges; Small UAV; DInSAR; Deflection

---

**1. Introduction**

Pekanbaru city (Figure 1) is the capital city of Riau province, Indonesia located 101°14' - 101°34' E and 0°25' - 0°45' N with sea level average from 5 - 50 meters. The northern part of this city is a plain area with average height 5 - 11 meter. The total area of Pekanbaru city is 632.26 km<sup>2</sup>. Pekanbaru city is the one of the main city in Indonesia with the population of 1.2 million people based on Center for Indonesia Statistic Board, Pekanbaru branch released on 2014. The economical in Pekanbaru growth above 10% in a year, this number is above of Indonesia's economy growth which has 4.79% (Center for

Indonesia Statistic Board, 2014). This rapid growth needs infrastructure facilities to support people activities, meanwhile, Pekanbaru city is the strategic city located at the center of Sumatera Island. With this position, Pekanbaru city is the connector of the north-south littoral at the Sumatera Island, also as the connector between east and west of this island.

This importance of Pekanbaru city requires supporting infrastructures inevitably. One them is bridge facility. Pekanbaru city was split into two because it passed the great river named Siak River, the river is recognized as well as the deepest river in Indonesia. Siak River divides Pekanbaru city located at the Senapelan sub-district, Rumbai sub-district, and Rumbai Pesisir sub-district.

The establishment of the bridge as the community liaison activities in Pekanbaru, provide enormous positive impact by making the groove Pekanbaru ground transportation becomes easier, but the construction of this bridge also pose a risk to their land-use change and the condition of the bridge due to the pressure exerted by the bridge and traffic activities that are in it. This study aims to determine the effect given or experienced by land due to the construction of the bridge.

The bridge is located on the Siak River area of Pekanbaru city. Siak I bridge located at  $0^{\circ}32'27.68''$  N and  $101^{\circ}26'13.65''$  E, was built in 1973 and available to use in 1977 with the length 355 meter. Siak II bridge located at  $0^{\circ}33'4.41''$  N and  $101^{\circ}24'1.89''$  E, was built in 1990 with length 190 meters.

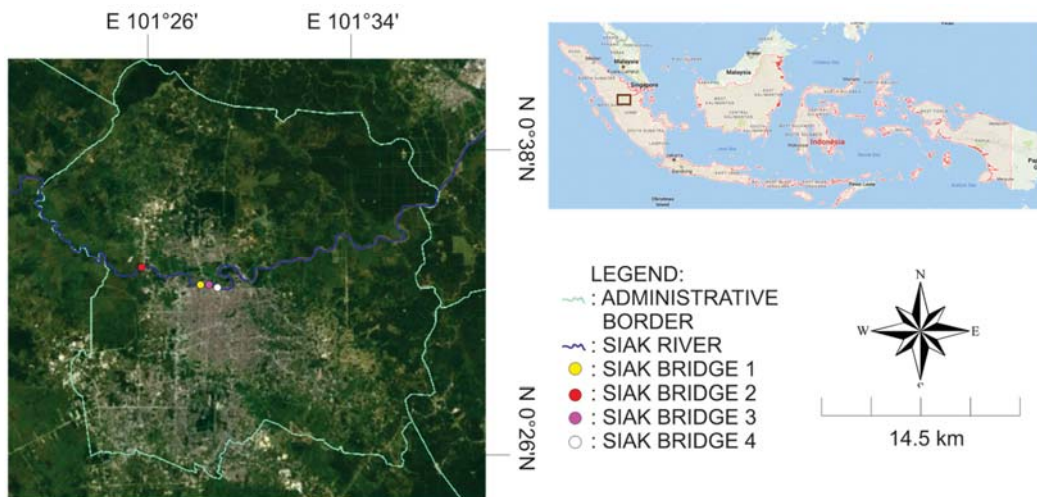

Figure 1. Map of Pekanbaru city, Riau Province, Indonesia.

## 2. Data and Method

Three methodologies were used for this research. Field mapping on Siak I, Siak II bridges were used small UAV with specifications: built-in camera with FOV (Field of View)  $94^{\circ}$  20 mm (35 mm format equivalent) f/2.8 lens, 1/2.3" sensor and effective pixels: 12 M connected to the built-in GPS. Pictures were taking among 2 weeks for the whole bridges, starting from 20 May 2016 until 3 June 2016. The pictures were rendered using some software to produce a 3D model of mapping area.

Land-site deformation measurement of the bridge stand was measured using differential interferometry measurement with ALOS PALSAR level 1.1 data, the date from 25 May 2007 and 20 April 2011.

To analyze the differential interferometry on the ALOS PALSAR Level 1.1 data, the software used to process it, then choose the baseline (B) by looking the highest number and it should be in the first process. This baseline influenced by topography. Influences of topography (h) in interferograms given by:

$$\phi_{topo} = -\frac{4\pi.B^2}{\lambda.R_1.\sin\theta_0} \quad (1)$$

After selecting the data, coregistration process will generate (figure 2) accurate determination of phase differences, coregistration produces the master and slave data which ready for coregistration to combine of those data. Coregistration data is ready for interferogram generation with a flattened condition and the result for calculating the complex correlation coefficient between two acquisitions or coherence for generating topographic phase correction. By reducing interferogram phase and topographic phase correction will generate the differential interferogram.

$$Differential_{Interferogram} = phase_{ifg} - phase_{topo} \quad (2)$$

Generating the topographic phase correction will be available to produce the phase filtering. We used 2 types of Goldstein filtering with 0.5 x 0.5 and 0.3 x 0.3 coherence threshold. The data is ready to be unwrapped after finishing phase filtering process.

The compile between wrapped phase and unwrapped phase data will produce vertical displacement map which given by calculation as below:

$$vertical_{displacement} = \frac{\phi_{unwrapped}.\lambda}{-4\pi.\cos\theta_i} \quad (3)$$

Where LOS-to-Vertical factor or incidence angle from satellite data.

Vertical displacement map will generate the vertical displacement map reference, as the reference to combining with pixel from the point we chosen by substitute equation 2 to the equation below:

$$vertical_{displacement\_reference} = (vertical_{displacement} + pixel_{value}) \quad (4)$$

Calculation of masking area with low coherence is to combine with the vertical displacement reference to get the result of interferometry. The calculation of masking area is given by:

$$ver_{disp\_ref\_mask} = IF (Coherence\ value) \geq (Scale\ value\ in\ meter) THEN 1 ELSE NaN \quad (5)$$

Masking of vertical displacement reference is resulting file for Geocoding and projection map that used WGS84 with SRTM 3sec digital elevation model and nearest neighbour resampling method in Range-Doppler terrain correction.

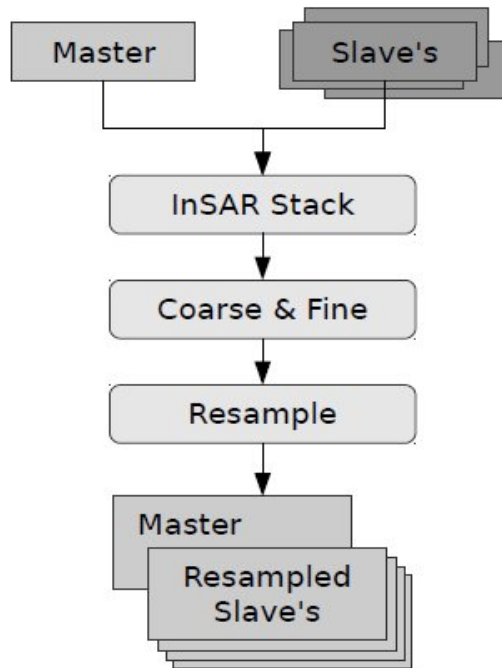

Figure 2. Flowchart of inteferometric co-registration.

### 3. Result and Discussion

#### 3.1. Area monitoring using small UAV

Mapping using a small UAV for Siak I bridge (Figure 3) and Siak II bridge (Figure 4) were used to produce a 3D result of the study area, using an overlapping technique to get the pictures of the study area, rendering software was used. The result from a 3D model of small UAV shows the land area of the bridge sites for Siak I, Siak II and residential area. The result showed no significant changes to the land especially for the land subsidence and land deformation. This analysis also supported by ALOS PALSAR differential interferometry analysis data in Pekanbaru city.



Figure 3. Location of Siak Bridges taken by Small UAV for Siak Bridge I.

#### 3.2. Differential Interferometry Synthetic Aperture Radar (DInSAR) analysis

Land deformation mapping on the site of Siak I, Siak II bridges shows the number that impacted in Pekanbaru city and around Siak bridges based on data analysis of ALOS PALSAR on 25 May 2007 and 20 April 2011. ALOS PALSAR Data Processing for these



scenes produces a differential interferogram (Figure 5) which was used further for processing to obtain the number of land deformation in this study area.

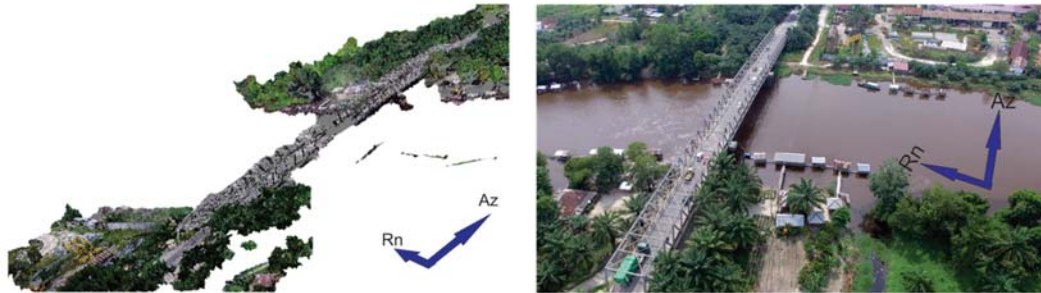

Figure 4. Location of Siak Bridges taken by Small UAV for Siak Bridge II.

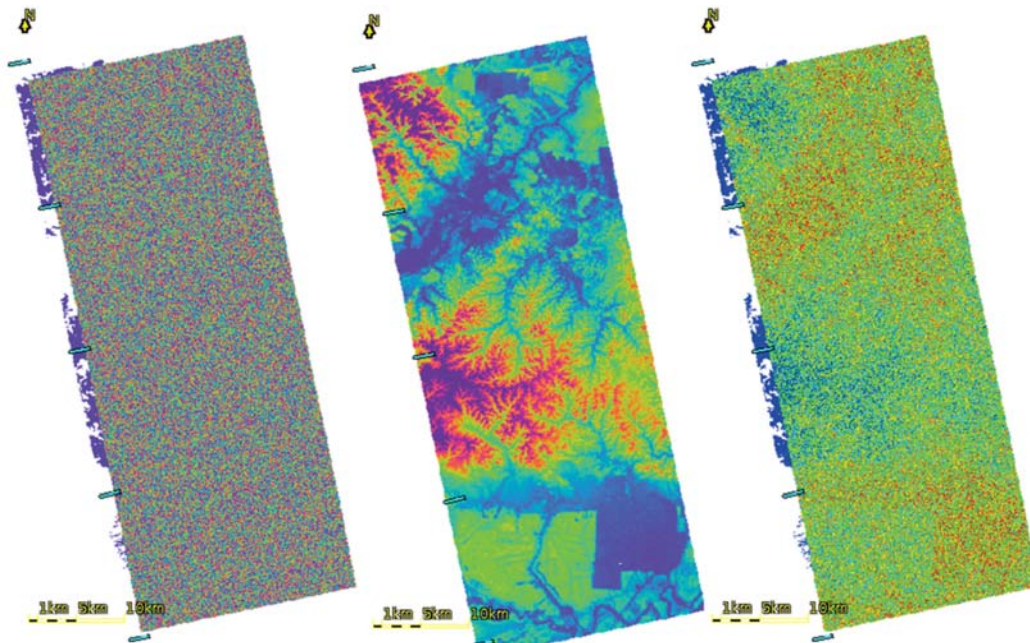

Figure 5. Location of Siak Bridges taken by Small UAV for Siak Bridge II.

Based on DInSAR analysis, Pekanbaru city has the lowest deformation value of -540.36 mm in several southern and western area. For the highest deformation value is 1,274.50 mm in the eastern part of Pekanbaru city (Figure 6). DInSAR analysis was used 4 types scale which are 0.01, 0.1, 0.5 and 0.6. DInSAR analysis also shows there was no land subsidence in Pekanbaru city in the range of 2007-2011. This analysis also shows the topography information of Pekanbaru city which are the east area has the higher topography than south and west areas.

Differential interferometry analysis on the Siak I bridge and Siak II bridge (Figure 7) show the deformation in these areas are positive. Siak I bridge has 81 cm deformation value. For Siak II bridge has 48 cm deformation value and this site is the lowest value compare to another site of Siak bridges. DInSAR analysis for Siak I bridge and Siak II bridge did not detect any significant negative land deformation. This result gives mean, for the site of all Siak bridges was not impacted the bridge to fail.

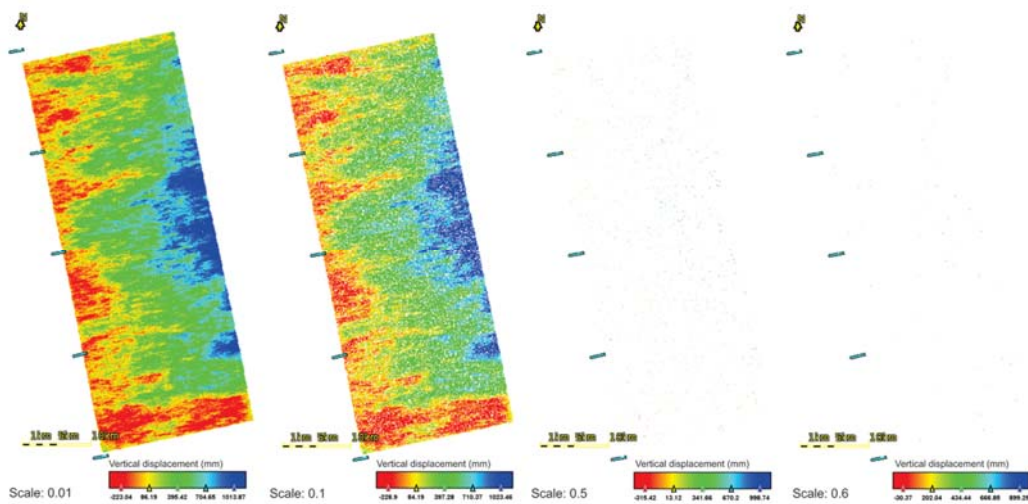

Figure 6. Differential Interferometry Image for Pekanbaru city.

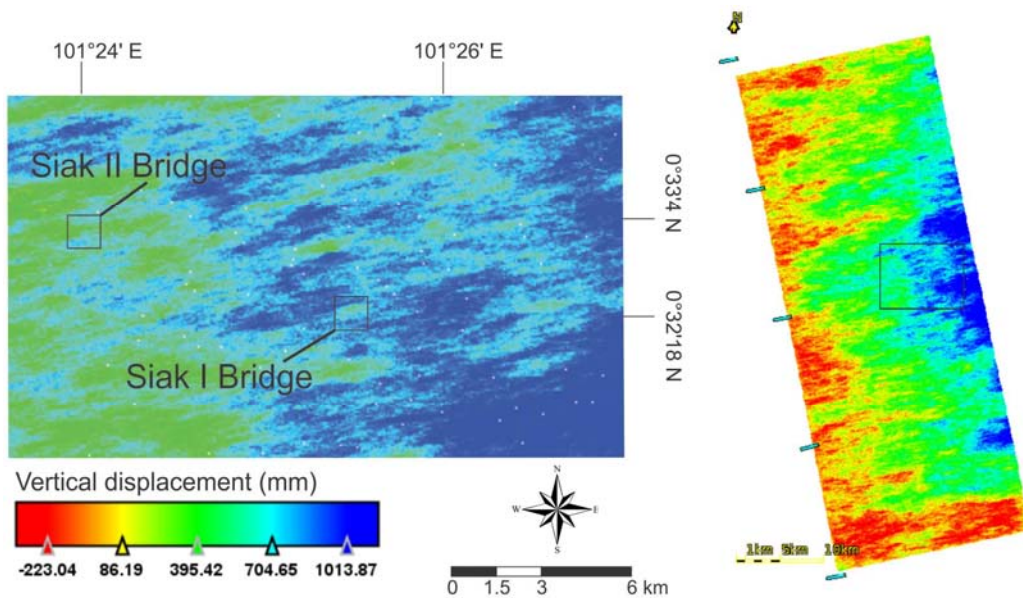

Figure 7. Differential Interferometry Image for Pekanbaru city.

### 3.3. Field observation for bridge deflection

Field observation show for the Siak Bridge I and II, there is no negative subsidence. For the land as the site of Siak Bridges stand; it still stable without no subsidence occurs detected.

## 4. Recommendation and Future Work

Periodical mapping using UAV needs to do in the future for at least 6 months to get the change of land-site by the time. The bridges need periodical maintenance,

especially for the Siak Bridge I and II, because these bridges have reached more than 20 years age.

## 5. Conclusion

The result of the study conducted on Siak bridges in Pekanbaru city is expected to provide input for Pekanbaru city government in preparing for the construction and preservation of existing bridges. The result of the mapping using small UAV's shows no area has decreased significantly in all regions around the site of Siak bridges land, UAV's mapping result is also supported by the analysis of land deformation using DInSAR analysis for ALOS PALSAR Data of Pekanbaru city that certifies the absence of negative surround Siak I bridge and Siak II bridge, Another supporting analysis is direct observation at Siak bridges. From the observation, big deflection did not find on the Siak I bridge and Siak II bridge. For further research, we will conduct another UAV mapping in the future and analyze the change detection for these bridges compare with current data.

## Acknowledgement

This work was supported by Research Board of Universitas Islam Riau and the EORC JAXA for providing ALOS PALSAR data; Japanese Government National Budget. The authors would like to thank Lembaga Penelitian Universitas Islam Riau for funding this research, also government of Riau Province to provide research location, Josaphat Microwave Remote Sensing Laboratory (JMRS�) at CEReS, Chiba University who provides laboratory to measure the samples, and Venture Business Laboratory (VBL), Chiba University.

## Reference

- Beiqi Shi, Chun Liu. 2015. UAV for Landslide Mapping and Deformation Analysis. International Conference on Intelligent Earth Observing and Applications 2015, edited by Guoqing Zhou, Chuanli Kang, Proc. of SPIE Vol. 9808, 98080P-1. doi: 10.1117/12.2207411.
- Center for Indonesia Statistic Board, 2014. <https://pekanbarukota.bps.go.id/Subjek/view/id/12#subjekViewTab3|accordion-daftar-subjek1>
- Chia-Sheng Hsieh, Mong-Han Huang, Tian-Yuan Shih, Jacques Angelier, Jyr-Ching Hu, Hsin Tung. 2011. Using differential SAR interferometry to map land subsidence: a case study in the Pingtung Plain of SW Taiwan. Nat Hazards. DOI 10.1007/s11069-011-9734-7
- Husnul Kausarian, 2015. Rock Mass, Geotechnical and Rock Type Identification Using SASW and MASW Methods at Kajang Rock Quarry, Semenyih, Selangor Darul Ehsan. Journal of Ocean, Mechanical and Aerospace -Science and Engineering-. Vol. 26. <http://www.eorc.jaxa.jp/ALOS/en/about/palsar.htm>
- Roni Ardiansyah, 2011. <https://ronymedia.wordpress.com/2011/12/08/perlukah-diragukan-kekuatan-jembatan-siak-iii/>
- Shi Hongyun, Yang Songlin, Liu Guang. 2011. The Application of InSAR in the Deformation Monitoring for Road Engineering - A Case Study: Dujiangyan, China. Fourth International Conference on Intelligent Computation Technology and Automation.

---

**Time Series InSAR for Interpretating 5 years Cycle of Mt. Bromo  
Eruptions in Indonesia by Using PALSAR and PALSAR-2  
to Assess Damages Assessment**

Arliandy P. Arbad<sup>1\*</sup> Wataru Takeuchi<sup>2</sup> and Y. Aoki<sup>3</sup>

<sup>1</sup>*Institute of Industrial Science, The University of Tokyo, 153-8505, Japan*

<sup>2</sup>*Institute of Industrial Science, The University of Tokyo, 153-8505, Japan*

<sup>3</sup>*Earthquake Research Institute, The University of Tokyo, 113-0032, Japan*

---

**Abstract**

Since 2010, Mount Bromo has erupted at least two times with high intensity has recorded. Regarding to CVGHM reported, Mount Bromo activity increased on 1 November 2015 and started erupting with lava on Tuesday morning, 26 January 2016. Based on the eruption evidences Mount Bromo is Strombolian Volcano, relatively mildly explosive at discrete but fairly regular intervals of seconds to minutes. Recently, remote sensing has played as an important role to observe volcano behaviour. We investigated ground deformation by interferometric SAR method related to ground structure before and after eruption. We expect the Time Series-InSAR deformation field to infer volume changes, geometries and locations of sources of deformation involved in the future eruption. Ground displacement in the radar line-of-sight (LOS) direction is obtained from the phase difference of synthetic aperture radar (SAR) pairs of the same area acquired at different times (interferograms) then be flattened by removing the topographic phase an inflating volcano (or any other landform) produces a pattern of concentric fringes in a radar interferogram from which the effects of viewing geometry and topography have been removed. InSAR studied in Mount Bromo has observed by e.g. Arliandy and Wataru (2016) the results are shown the displacement changes around Mount Bromo area up to 26 Cm, where is the higher shifted in 2015 eruption. The results are allowed us to understand evidences of disaster in the field and could implemented to urban plan engineering in particular civil engineering work and mitigation assessment to reduce number of damages and fatalities.

**Keywords**

Volcano ; Eruptions ; InSAR ; Civil Engineering Assessment

---

**1. Introduction**

Centre of Volcanology and Geological Hazard Mitigation (CVGHM) Indonesia recorded of tectonic activities of Mt. Bromo, their recorded tectonic activity dominated by continuing tremor vibration with maksimum amplitude which tend to fluctuate. Mount Bromo status is now *siaga* (level 3 of 4). Potential to evoke freatik eruptions and magmatic materials, distribution materials such as ash plumes and pyroclastis fall will occur around

---

\* Corresponding author. Tel.: 080-8740-7886  
E-mail address: arbad@iis.u-tokyo.ac.jp

the volcano. Mount Bromo is located in East Java Province, one of the most active volcanoes in Indonesia which short eruptions cycle among 1 year to 5 years.

The objective of this study is to support disaster assessment due to volcanic activities regarding to deformations caused eruptions in 2010 and 2015 by using time series InSAR (interferometric SAR) in 5year cycles of mount Bromo. The most commonly rapid technique of assessment is used remote sensing method (Lu *et al.*, 2007), remote sensing has been largely implemented to rapid assess damages assessment (e.g Voigt *et al.*, 2011) after Haiti earthquake in 2010. Long time observations are needed to learn risk and vulnerability assessments to understand and possibly mitigate the impact of such catastrophic events on human beings and their environment.

## 2. Methodology

Mount Bromo is located in East Java Province, one of the most active volcanoes in Indonesia which short eruptions cycle among 1 year to 5 years. Synthetic aperture radar (SAR) is a technique that allows highresolution radar images to be formed from data acquired by sidelooking radar instruments carried by aircraft or spacecraft (Curlander and McDonough., 1991). The amplitude of a SAR image can be interpreted in terms of the scattering properties of the Earth's surface.

### 2.1 Data Processing

For analyzing the deformation events in 2007 to late 2011 we used SAR data derived from ALOS/PALSAR and another observations from 2015 to the early of 2016 we used SAR data derived from ALOS2/Palsar-2 Images which L-band frequency characteristic onboard from Advanced Land Observing Satellite (ALOS2) with active microwave sensor. Table below show details data are used for this study.

**Table 1.** Data information

Date	Sensor	Processing Type	Polarization	Orbit
20071225	ALOS/Palsar	L.1.0	HH	Descending
20081111	ALOS/Palsar	L.1.0	HH	Descending
20090814	ALOS/Palsar	L.1.0	HH	Descending
20100517	ALOS/Palsar	L.1.0	HH	Descending
20101117	ALOS/Palsar	L.1.0	HH	Descending
20110217	ALOS/Palsar	L.1.0	HH	Descending
20150325	ALOS2/Palsar2	L.1.1	HH	Descending
20160504	ALOS2/Palsar2	L.1.1	HH	Descending

PALSAR-2 is L-band frequency (active microwave remote sensing) which characterize enable to penetrate cloud (cloud-free) and day-and-night observation. Images below are used for interferometric SAR Processing. The synthetic aperture radar signal processing could be implemented simply as follow below.

### 2.2 Flow Chart

In this research we proposed time series InSAR method in the conventional single-interferogram approach, derives from two radar images of the same area acquired at different times to measure ground displacement. The technique uses the phase difference of backscattered signals from the two acquisitions to measure differential motion in the Line Of Sight (LOS) direction include vertical and horizontal components.

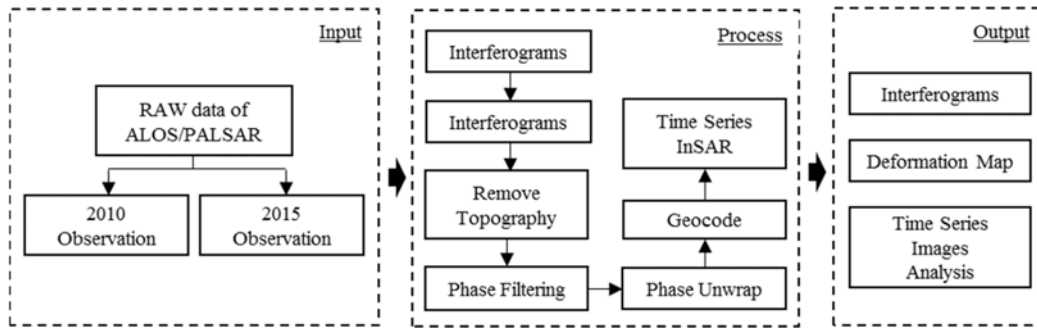

**Figure 1.** Flowchart Study

We presented the time series interferometric SAR analysis using sigmasar developed by JAXA (Japan Aerospace Exploration Agency), to get interferogram and line of sight displacements, the interferometric phase was unwrapped with the SNAPHU program. To show ground deformation with high spatial resolution and accuracy on the large area observation we used D-InSAR (Differential Synthetic Aperture Radar Interferometry) explained by Massonet (2008); Gabriel A K *et al.*, (1989) which phase can be subtracted from the SAR interferogram to remove topography. DInSAR used to analysis the line of sight displacement for monitoring and detecting change volcano in long-term and short-term (Papageorgiou, E *et al.*, 2012) for each images and also allows for studying fault mechanism (Currenti G *et al.*, 2010). Interferometry is the process of multiplying one SAR image by the complex conjugate of a second SAR image resulting in an interferogram, the phase of which is the phase difference between the images, various techniques have been developed (Sousa *et al.*, 2010).

### 3. Result and Discussion

We have discussed above, persistent scatterer and small baseline approaches are optimised for different models of surface scattering. The former technique targets resolution cells dominated by a single scatterer and the latter targets cells with many scatterers. Here we are trying to see deformations on each single processing every year within 2010 eruption and late 2016 eruption on mount Bromo.

#### 3.1 Past Study

Regarding to the our past processing, the unwrapping result and the interferograms could give us some hints to interpretate land surface changes around the volcano. Slope deformation surrounding the end of 2010 eruptions, with the blue line marking the outline of the slope instability in graph (2a,c) representative from A to B where is deformation occurred until 5 Cm inside the calderas. (2b,d) High subsidence of the centre caldera is seen prior to the eruption in 2015; Look at (2b) during the eruptions in the end of 2015 until beginning of 2016, ~8 Cm of LOS slope displacement can be seen on the southwest sector of mount Bromo during the period in the end of 2015 until February 2016 atleast 6 quakes recorded as continuously tremors quake which maximum of dominant amplitude around 1-24 mm (PVMBG., 2016) some evidences have found around the mount Bromo such as another volcanic activity occurred in the southern part regarding to mount Semeru, the unique of mount Bromo is located in the same calderas with another active volcanoes. The activity of mount Bromo associated to the megathrust and a continuous zone of back-arc thrusting extending 2000 km from east Java to north of Timor which tend to be come a new seismic threat over the Java.

Since eruption 2010, mount Bromo still continuing tremors as reported by Centre of Volcanology and Geology Hazard Mitigation in Bandung, Indonesia. Which characterize

Strombolian eruption, mount Bromo eruptive activity can be precised long-term because the conduit system of strombolian volcano is not strongly affected by the eruptive activites, the eruptive system can insisntently reset by itself.

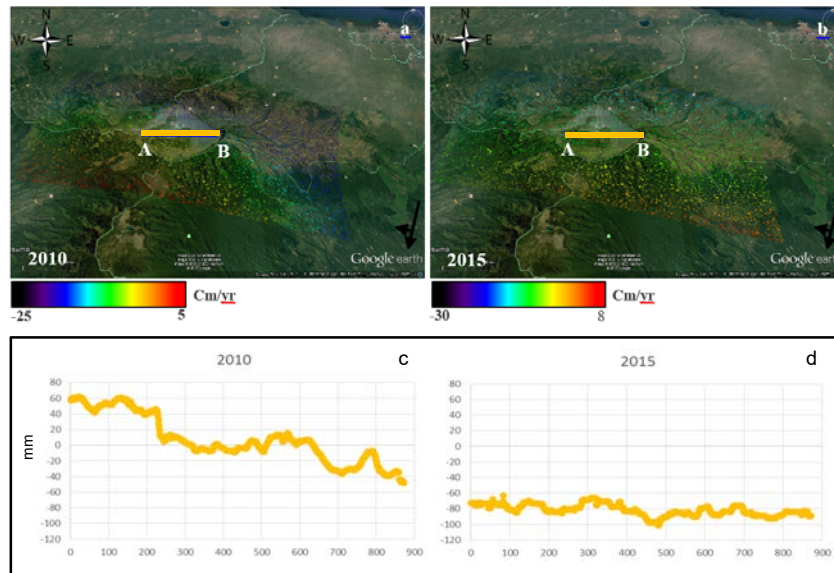
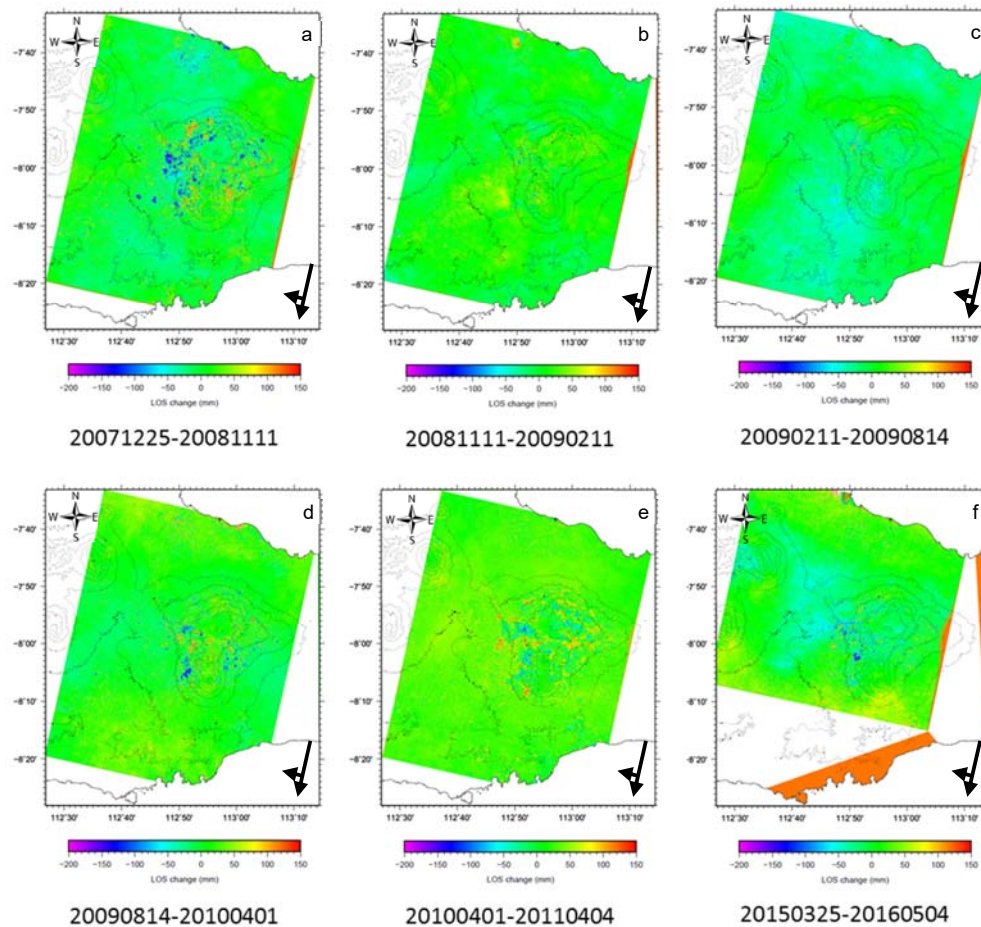

**Figure 2.** Line of sight displacements are used to highlight the deformation in interferograms of pre-eruptive in 2010 Eruption and and post-eruptive in 2015 Eruption, (taken from Arliandy *et al.*, (2016)).

### 3.2 Present Study

The result below given the new sight of volcanic activities monitoring and implementing of InSAR to observe volcano. In the order to support primary overview and quick orientation on the surface even before any recently acquired post-event satellite data became available. In this case we started observe mount Bromo in the late of (December) 2007 as shown in figure (3a) which obtained from two images within one year, it clearly shows  $\sim 10$  Cm subsidences occurred surrounding the mount Bromo calderas. In figure (3b) taken from 11<sup>th</sup> November 2008 to 11<sup>th</sup> Feb 2009 shows the area surrounding mount Bromo had not lot of changes, only some are inside the calderas are changed in small frequency. Southern and northern of mount Bromo calderas or rather southwest part of mount Semeru there are some areas had changed as subsidences and consistently around  $\sim 5$  Cm as shown in figure (3c).

Move to figure (3d) some areas had changed around  $\sim 10$  Cm within six months observation acquired from 14<sup>th</sup> Aug 2009 to 1<sup>st</sup> Apr 2010, the situation relatively same with the images is shown from figure (3a) where is the quite big eruption occurred in late of 2010 (CVHGM, 2016). These trends line since 2007 followed consistenly in figure (3e) which the eruption happened in this observation within 1<sup>st</sup> April 2010 to 4<sup>th</sup> April 2011. Interesting fact in this figure we can see clearly, some areas surrounding the mount Bromo calderas had changed uplift even big eruption occurred. We could not presented continuously since 2014 because availability the images from ALOS satellite which not observed at that time. It was absence from our observations. In the late 2015 and recently, mount Bromo still continuing eruption. Figure (3f) is shown lately observation obtained from 25<sup>th</sup> Mar 2015 to 4<sup>th</sup> May 2016 by (ALOS2/PALSAR) subsidences was occurred in southwest of mount Bromo calderas reach  $\sim 15$  Cm and northern regions of mount Bromo relative stable had not changes at the time observation.



**Figure 3.** Interferogram Images

The recently research by Koulali *et al*, (2016) used Global Positioning System (GPS) to measure of surface deformation for showing that the convergence between the Australian Plate and Sunda Block in eastern Indonesia is partitioned between the megathrust and a continuous zone of back-arc thrusting extending 2000 km from east Java to north of Timor. Although deformation in this back-arc region has been reported previously, its extent and the mechanism of convergence partitioning have hitherto been conjectural. GPS observations establish that partitioning occurs via a combination of anticlockwise rotation of an arc segment called the Sumba Block, and left-lateral movement along a major NE-SW strike-slip fault west of Timor. We also identify a westward extension of the back-arc thrust for 300 km onshore into East Java, accommodating slip of  $\sim 6$  mm/yr. These results highlight a major new seismic threat for East Java and draw attention to the pronounced seismic and tsunami threat to Bali, Lombok, Nusa Tenggara, and other coasts along the Flores Sea.

### 3.3 Mount Bromo Cycles

Tectonic/quake activity dominated by continuing tremor vibration with maksimum amplitude which tend to fluctuate. Based on the tectonic analysis, Mount Bromo status is now *siaga* (level 3 of 4). Potential to evoke freatik eruptions and magmatic materials, distribution materials such as ash plumes and pyroclastis fall will occur around the volcano (PVMBG report., 2016). The eruption is still on going strong and it counts now as



Bromo's biggest eruption recorded in history since official records began in 1804. Following the recently news from Kompas national media in Indonesia, Seismic activity on Sunday (25/09/2016) showed continuous volcanic tremor with a dominant amplitude 4 mm. Seismic activity, which is dominated by volcanic earthquake Shallow, tremor vibrations, and deformation, which showed inflation. History recorded, Bromo has erupted at least about 50 times since 1775. The eruptions were mostly Strombolian in type (Abidin H. *et al.*, 2004).

Those evidences are consistent with the existence in the the mount Bromo like a mount Bambouto, Central Africa of a volcanic phase prior to the ignimbritic deposits South of the massif (Nono A. *et al.*, 2004); this is interpreted as an explosive strombolian phase; the trachyte being penecontemporaneous with the calderaforming eruption seemed from small changes inside the calderas prior to figure (3a) to (3f) characterised both by strombolian and effusive activities, was observed until the end of 2015. During the phase 5years eruption, mount Bromo shows the subsidences around the calderas, those evidences are related to article was published by volcano discovery due to beginning 2011 eruption noted that the eruption's has caused widespread damage due to near continuous ash fall, damaging buildings, roads, and destroying farmland. The most heavily affected areas northwest of Bromo have been declared disaster areas by the Indonesian government.

#### 3.4 Future Study

We will try to arrange matrix of AHP assessment by using GIS tools regarding the result given the new sight of volcanic activities monitoring and implementing of InSAR to observe volcano. Based on our study, we plan to check ground truth (field survey) analysis by surveying surrounding the volcano to understand of volcanic activities associated to the fault and vegetation surrounding the mount Bromo. Risk management is an important roles for every construction (e.g. Hjelmstad *et al.*, 2010), a good concept of risk management must know about how we can identify, analyze, treat and assess the risks present in each regions based on their own disaster characteristics.

## 4. Conclusion

We have presented here some of the recent developments (e.g Ferretti *et al.*, 2000) in time series InSAR Processing by using PALSAR and PALSAR-2 data can be used to rapid damages assessment due to subsidences and volumetric changes in the areas of volcanoes. We used InSAR processing to know whole area affected due to volcanic activities associated to the landslides. Rapid assessments by using SAR images more details explained (e.g Dell'Acqua *et al.*, 2009; and Brunner *et al.*, 2010) as damages assessment.

In the 5years cycle of mount Bromo, InSAR time series is an excellent method to observe the evidences of ground surface movement for interpreting characteristics mount Bromo as a point of damages assessment, Indonesia is the most volcanically active in the world, with numerous eruptions each year and millions of people living on the flanks of the volcanoes (Loughlin *et al.*, 2015).

## Acknowledgements

Thankyou LPDP (Indonesia Endowment Fund For Education) Scholarship for funding, Indonesia Ministry of Finance. JAXA (Japan Aerospace Exploration Agency) to

provide data images. Remote Sensing of Environment and Disaster Laboratory, Industrial Institute of Technology University of Tokyo and also Earthquake Research Institute The University of Tokyo for sharing knowledge on volcano sense.

## References

- Abidin, H.Z., Andreas, H., Gamal, M., Hendrasto, M., Suganda, O.K., Purbawinata, M.A., Meilano, I. and Kimata, F., 2004. The deformation of Bromo Volcano (Indonesia) as detected by GPS surveys method. *Positioning*, 1(08). Brunner, D., Lemoine, G. and Bruzzone, L., 2010. Earthquake damage assessment of buildings using VHR optical and SAR imagery. *IEEE Transactions on Geoscience and Remote Sensing*, 48(5), pp.2403-2420.
- Arliandy, P.A., Takeuchi, W., 2016. Investigation of Ground Deformation Caused by Volcanic Eruptions in 2010 and 2015 at Mt. Bromo-Indonesia Observed by PALSAR and PALSAR-2. *Asian Conference on Remote Sensing 2016*. Srilanka
- Curlander, J.C., McDonough, R.N., 1991. Synthetic Aperture Radar — Systems and Signal Processing. John Wiley & Sons, New York
- Dell'Acqua, F., Lisini, G. and Gamba, P., 2009, July. Experiences in optical and SAR imagery analysis for damage assessment in the Wuhan, May 2008 earthquake. In *2009 IEEE International Geoscience and Remote Sensing Symposium* (Vol. 4, pp. IV-37). IEEE.
- Ferretti, A., Ferrucci, F., Prati, C. and Rocca, F., 2000. SAR analysis of building collapse by means of the permanent scatterers technique. In *Geoscience and Remote Sensing Symposium, 2000. Proceedings. IGARSS 2000. IEEE 2000 International* (Vol. 7, pp. 3219-3221). IEEE.
- Hjelmstad, K.D. and Shin, S., 1997. Damage detection and assessment of structures from static response. *Journal of Engineering Mechanics*, 123(6), pp.568-576.
- Gabriel, A.K., Goldstein, R.M. and Zebker, H.A., 1989. Mapping small elevation changes over large areas: differential radar interferometry. *Journal of Geophysical Research: Solid Earth*, 94(B7), pp.9183-9191.
- Koulali, A., S. Susilo, S. McClusky, I. Meilano, P. Cummins, P. Tregoning, G. Lister, J. Efendi, and M. A. Syafi'i (2016), Crustal strain partitioning and the associated earthquake hazard in the eastern Sunda-Banda Arc, *Geophys. Res. Lett.*, 43,1943–1949.
- Loughlin, S., Sparks, S., Brown, S., Jenkins, S. and Vye-Brown, C. eds., 2015. *Global Volcanic Hazards and Risk*. Cambridge University Press.
- Lu, Z., Kwoun, O. and Rykhus, R., 2007. Interferometric synthetic aperture radar (InSAR): its past, present and future. *Photogrammetric engineering and remote sensing*, 73(3), p.217.
- Massonnet, D. and Souyris, J.C., 2008. *Imaging with synthetic aperture radar*. CRC Press.
- Nono, A., Njonfang, E., Dongmo, A.K., Nkouathio, D.G. and Tchoua, F.M., 2004. Pyroclastic deposits of the Bambouto volcano (Cameroon Line, Central Africa): evidence of an initial strombolian phase. *Journal of African Earth Sciences*, 39(3), pp.409-414.
- Papageorgiou, E., Foumelis, M. and Parcharidis, I., 2012. Long- and short-term deformation monitoring of Santorini Volcano: unrest evidence by DInSAR analysis. *IEEE Journal*

*of Selected Topics in Applied Earth Observations and Remote Sensing*, 5(5), pp.1531-1537.

Sousa, J.J., Ruiz, A.M., Hanssen, R.F., Bastos, L., Gil, A.J., Galindo-Zaldívar, J. and de Galdeano, C.S., 2010. PS-InSAR processing methodologies in the detection of field surface deformation—Study of the Granada basin (Central Betic Cordilleras, southern Spain). *Journal of Geodynamics*, 49(3), pp.181-189.

Voigt, S., Schneiderhan, T., Twele, A., Gähler, M., Stein, E. and Mehl, H., 2011. Rapid damage assessment and situation mapping: learning from the 2010 Haiti earthquake. *Photogrammetric Engineering and Remote Sensing (PE&RS)*, 77(9), pp.923-931.

"Bromo Volcano (Tengger Caldera, East Java, Indonesia): Eruption Nov 2010-Feb 2011." Bromo Volcano (Tengger Caldera, East Java, Indonesia): Eruption Nov 2010-Feb 2011. N.p., n.d. Web. 23 Oct. 2016.  
<https://www.volcanodiscovery.com/photos/bromo/eruption2011.html>

"Gunung Bromo Berstatus Siaga, Ini Titik Aman Untuk ..." N.p., n.d. Web. 23 Oct. 2016.  
<http://travel.kompas.com/read/2016/09/26/133419427/gunung.bromo.berstatus.siaga.ini.titik.aman.untuk.wisatawan>

Report of mount Bromo Activities Retrieved from <http://www.vsi.esdm.go.id/>

## **Risk Assessment of Land Subsidence in Kathmandu Valley, Nepal**

Richa Bhattarai, Haireti Alifu, Akihiko Kondo, Ryutaro Tateishi

*Center for Environmental Remote Sensing (CEReS), Chiba University, 1-33 Yayoicho, Inage  
Ward, Chiba, 263-8522, Japan*

---

### **Abstract**

Land subsidence is an environmental geological phenomenon that causes slow lowering of ground surface elevation. With this slow deformation in land comes great risks to buildings and infrastructures resulting in significant economic losses and in worst case scenarios loss of human life as well. Therefore, it is important to assess risk beforehand for proper risk management.

The objective of this research is to assess risk in the areas affected by land subsidence in Kathmandu Valley, Nepal using Geographic Information System (GIS) processing. A land subsidence map of Kathmandu valley (from 2007 to 2010) has been generated using Differential synthetic aperture radar interferometry (D-InSAR) technique. Geophysical data, that includes the subsidence volume, land subsidence velocity and groundwater exploitation intensity of the affected area will be utilized to estimate the future land subsidence. Social data, that includes population density, gross domestic product/km<sup>2</sup> and construction land proportion will be utilized to estimate the vulnerability. Finally, the estimated land subsidence and estimated vulnerability will be combined together to obtain a land subsidence risk map. Different cases with and without governmental prevention and reduction policy or action will also be employed to compare the differences.

This result is expected to be useful for the government and interested stakeholders for better understanding of the prevailing situation and the changes that can be brought through interventions. The generated result will also be helpful for disaster prevention policy-making

### **Keywords**

Land Subsidence; Risk Assessment; Kathmandu Valley; D-InSAR; GIS

---

### **1. Introduction**

Kathmandu Valley, the capital city of Nepal is the largest urban agglomerate in terms of economic activities and population. The ever increasing dense population and economic growth induces the intensive exploitation of land and water resources. This haphazard exploitation along with the geologic setting of the valley makes it prone to land subsidence. Land subsidence is an environmental geological phenomenon that causes slow lowering of ground surface elevation (Hu, et al., 2009). The problem of land subsidence was first included by the UNESCO program of the International Hydrological Decade(IHD), 1965-74. Since then this problem has been documented throughout the globe. Some of the places suffering from land subsidence are Tokyo, Japan (Yamaguchi,

1969), Mexico (Adrian et al., 1999), Houston- Galveston Region, TX, USA (Gabrysch and Neighbors 2000), Jakarta, Indonesia (Abidin et al., 2001), Ravenna, Italy (Teatini et al., 2005), Pingtung Plain, Taiwan (Hu et al., 2006) and China (Xu et al. 2008). Land subsidence can induce geological disasters, damage infrastructure, and contribute to economic loss that could directly affect the sustainable development.

In case of Kathmandu valley, the first land subsidence map was generated for the period of 2007 to 2010 prior to this research. The results showed areas of subsidence in densely populated areas and areas with high economic activities. Land subsidence is just a geological phenomenon either triggered by natural or anthropogenic activities but when this phenomenon has the probability of resulting harmful consequences or the expected loss (of lives, property, livelihoods, economic activities or environment) then it is considered as risk. (Hu et al., 2009). Risk factors are compounded by the rapid increase in the urban population and economic development (Wang et al., 2012). Therefore, it is necessary to assess land subsidence risk for decision and policy makers to prevent a huge potential disaster.

The several approaches for land subsidence risk assessment include statistical models and expert system methods. These models include neuro-fuzzy inference system (ANFIS) (Park et al. 2012), artificial neural network (ANN) (Kim et al., 2009; Choi et al., 2010), weight of evidence (WOE) (Oh and Lee, 2010), multi-criteria decision model (Mancini et al., 2009), frequency ratio (FR) (Oh et al. 2011; Suh et al., 2013) and analytic hierarchy process (AHP) (Putra et al., 2011; Jiang et al., 2012; Huang et al., 2012). However, most of these models were adopted to study land subsidence resulted from coal mining.

In this study, three factors (hazard, vulnerability and capability of disaster prevention and reduction) were selected for quantitative evaluation. The main objective of this research is to assess land subsidence risk in Kathmandu valley, Nepal using the Risk Index method, ArcGIS Spatial Analyst and the Analytic Hierarchy Process.

## **2. Methods and Materials**

### *2.1. Study Area*

The Kathmandu valley, the capital and the largest urban agglomerate of Nepal is located in the central part of the country between 27°32'13" and 27°49'10" N latitudes and 85°11'31" and 85°31'38" E longitudes. It covers an area of 569.8 km<sup>2</sup> and has a population density of 19,250 per km<sup>2</sup> as per 2012 census. The area is relatively flat with slopes less than 1° with soil having predominantly loamy and boulder texture. It stands at an elevation of approximately 1,400 m (4,600 ft). The city has two principle landforms: alluvial and flood plains along river and slightly more elevated river terraces. The valley is bowl shaped with draining towards the center of the basin.

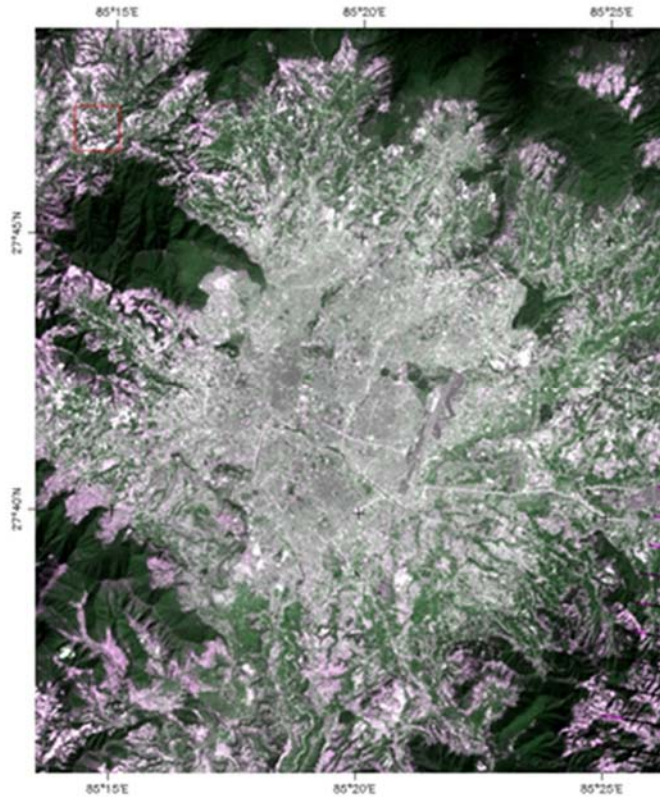

Figure 1. Landsat Image of Kathmandu Valley (2013)

## 2.2. Methodology

Three factors, hazard, vulnerability and the capability of disaster prevention and reduction will be considered for the quantitative evaluation of risk. The Risk Index Method, ArcGIS Spatial Analyst and the Analytic Hierarchy Process will be employed to assess the risk of land subsidence.

*Risk Index Method:* This method will be employed for the quantitative estimation of risk by following the underneath relationship (Lirer and Vitelli, 1998)

$$D_R = f(H, V, R) \quad (1)$$

where,  $D_R$  is the disaster risk  
 H is the Hazard  
 V is the Vulnerability  
 R is the capability of disaster prevention and reduction.

Hazard is the probability that disaster will occur in a given area within a given period of time. Similarly, vulnerability is a measure of susceptibility to physical harm or damage due to a disaster.

*ArcGIS Spatial Analyst:* The tools like spline interpolation, reclassification and raster calculator tool in the ArcGIS will be used for the analysis. Spline interpolation helps to create a raster surface on the basis of subsidence volume and velocity.

Reclassification as well as raster calculator tool deals with the different aspects of evaluation indices.

*Analytic Hierarchy Process:* This process will be employed for the criteria weighting. Analytic Hierarchy Process is a multi-criteria mathematical evaluation method used for decision making. Here, hierarchical structures are used to quantify relative priorities for a given set of elements on a ratio scale set by the user.

A simple flowchart for the methodology is shown in **Figure 2** below. Geophysical data, that includes the subsidence volume, land subsidence velocity and groundwater exploitation intensity of the affected area will be utilized to estimate the future land subsidence i.e. Hazard. Different from sudden disasters, land subsidence is a slow-onset geohazard and is accumulated over years. Therefore, the accumulative subsidence volume is the key indicator in evaluating the land subsidence hazard (Wang 2006; Wei, 2006). Land subsidence velocity is included as the hazard evaluating indicator to demonstrate the trend of subsidence. The ground water exploitation intensity is also used as an indicator because groundwater extraction is considered as the primary cause of subsidence in the area.

Social data, that includes population density, gross domestic product/km<sup>2</sup> and construction land proportion will be utilized to estimate the vulnerability. The level of socioeconomic development is directly proportional to vulnerability; the more developed the economy and the more dense the population the more the changes of damage and physical harm. The estimated land subsidence and estimated vulnerability will be combined together to obtain a land subsidence risk map. Different cases with and without governmental prevention and reduction policy or action will also be employed to compare the differences. Case 1 is with no governmental prevention and reduction policy or action whereas Case 2 is with government action to reduce ground water exploitation and finally Case 3 is with government action to prevent/reduce construction land proportion. Finally, three different land subsidence risk map will be obtained by employing these three different cases.

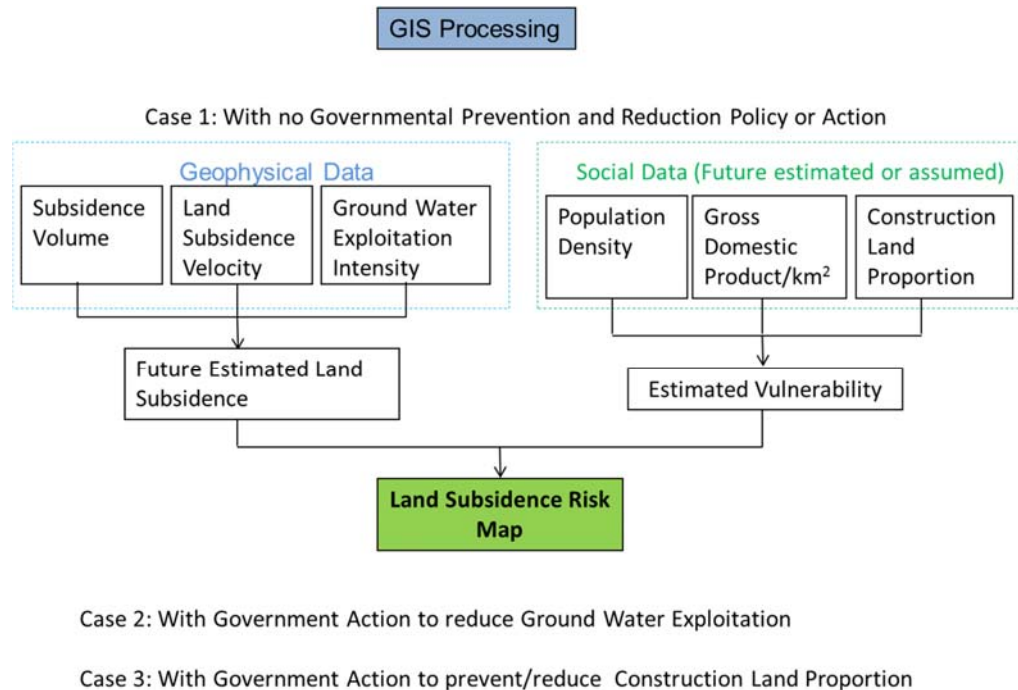

Figure 2. Methodology Flowchart

### 3. Expected Result

This is an ongoing research; therefore, the results are not obtained yet. But, eventually, after applying the above mentioned method; a land subsidence hazard map, a land subsidence vulnerability map and finally three different risk maps is expected to be obtained. The result map will be zoned in terms of very high, high, medium, low and very low risk/hazard/vulnerability areas.

This result is expected to be useful for the government and interested stakeholders for better understanding of the prevailing situation and the changes that can be brought through interventions. The generated result will also be helpful for disaster prevention policy-making

### References

- Abidin, HZ., Djaja, R., Darmawan, D., Hadi, S., Akbar, A., Rajiyowiryono, H., Sudibyo, Y., Meilano, I., Kasuma, MA., Kahar, J., Subarya, C. (2001). Land subsidence of Jakarta (Indonesia) and its geodetic monitoring system. *Nat Hazards* 23(2-3):365-387
- Adrian, OG., Rudolph, LD., Cherry AJ. (1999). Analysis of long-term land subsidence near Mexico City: field investigations and predictive modelling. *Water Resource Res* 35(11):3327-3341
- Choi, J., Oh, H.J., Won, J.S., and Lee, S. (2010). Validation of an artificial neural network model for landslide susceptibility mapping. *Environ Earth Sci*, 60:473-483. DOI: 10.1007/s12665-009-0188-0
- Gabrysch, RK., Neighbors RJ. (2000). Land-surface subsidence and its control in the Houston-Galveston region, TX, 1906-1995. In: *Proceedings 6th international symposium. Land Subsidence, Ravenna, Italy, September 2:81-92*
- Huang, B.J. Shu. L.C., and Yang, Y. S. (2012). Groundwater Overexploitation Causing Land Subsidence: Hazard Risk Assessment Using Field Observation and Spatial Modelling. *Water Resour Manage*, 26:4225-4239. DOI 10.1007/s11269-012-0141-y
- Hu, B., Zhou, J., Wang, J., Chen, Z., Wang, D., Xu, S. (2009). Risk assessment of land subsidence at Tianjin coastal area in China. *Environ Earth Sci* 59, pp. 269-276.
- Hu, J.C., Chu, H.T., Hou, C.S., Lai, T.H., Chen, R.F., Nien, P.F. (2006). The contribution to tectonic subsidence by groundwater abstraction in the Pingtung area, southwestern Taiwan as determined by GPS measurements. *Quatern Int* 147:62-69
- Jiang, Y., Jia, S.M., and Wang, H.G. (2012). Risk assessment and management of land subsidence in Beijing Plain. *ZHONGGUO DIZHIZAIHAI YU FANGZHI XUEBAO*, 1:55-60. (In Chinese)
- Kim, K.D., Lee, S., and Oh, H.J. (2009). Prediction of ground subsidence in Samcheok City, Korea using artificial neural networks and GIS. *Environ Geol*, 58:61-70. DOI:10.1007/s00254-008-1492-9
- Lirer, L. and Vitelli, L. (1998). Volcanic risk assessment and mapping in the Vesuvian area using GIS. *Nat Hazards* 17:1-15
- Mancini, F., Stecchi, F., and Gabbianelli, G. (2009). GIS-based assessment of risk due to salt mining activities at Tuzla (Bosnia and Herzegovina). *Engineering Geology*, 109:170-182.
- Oh, H.J., and Lee, S. (2010). Assessment of ground subsidence using GIS and the weights-of-evidence model. *Engineering Geology*, 115: 36-48.
- Oh, H.J., and Lee, S. (2011). Integration of ground subsidence hazard maps of abandoned coal mines in Samcheok, Korea. *International Journal of Coal Geology*, 86:58-72.
- Park, I., Choi J., Lee, M.J. and Lee, S. (2012). Application of an adaptive neuro-fuzzy inference system to ground subsidence hazard mapping. *Computers & Geosciences*, 48: 228-238.



- Putra D.P.E, Setianto1 A., Keokhampui1 K., and Fukuoka, H. (2011). Land Subsidence Risk Assessment Case Study: Rongkop, Gunung Kidul, Yogyakarta-Indonesia. The 4th AUN/SEED- Net Regional Conference on Geo-Disaster Mitigation in ASEA, 25-26, October, 2011, Conference
- Suh, J., Choi, Y., Parkh, D., Yoon, S.H., and Go, W.R. (2013). Subsidence Hazard Assessment at the Samcheok Coalfield, South Korea: A Case Study Using GIS. *Environmental & Engineering Geoscience*, XIX (1): 69–83.
- Teatini, P., Ferronato, M., Gambolati, G., Bertoni, W., Gonella, M. (2005). A century of land subsidence in Ravenna, Italy. *Environ Geol* 47:831–846
- Wang, G.L. (2006). Preliminary studies on dangerous grading standard of land subsidence. *Shanghai Geol* 4:39-43
- Wang, J., Gao, W., Xu, S., Yu, L. (2012). Evaluation of the combined risk of sea level rise, land subsidence, and storm surges on the coastal areas of Shanghai, China. *Climatic Change* 115:537-558
- Wei, F.H. (2006). Researches on geological hazard and risk zonation in Tangshan Hebei. Dsc. Thesis, China Univ Geosci, pp 89-90
- Xu, Y.S., Shen, S.L., Cai, Z.Y., Zhou, G.Y. (2008). The state of land subsidence and prediction approaches due to groundwater withdrawal in China. *Nat Hazards* 45:123-135
- Yamaguchi, R. (1969). Water level change in the deep well of the University of Tokyo. *Bull Earthquake Res Inst* No.47.

---

## **Geological Structure Delineation of Kepahiang Geothermal Prospect using Remote Sensing Techniques, Bengkulu, Indonesia**

Agil Gemilang R<sup>(a)</sup>, Cipta Endyana<sup>(b)</sup>, Aton Patonah<sup>(b)</sup> Boy Yoseph<sup>(b)</sup>

*<sup>(a)</sup>Students at Faculty of Geological Engineering Padjadjaran University*

*<sup>(b)</sup>Lecture at Faculty of Geological Engineering Padjadjaran University*

---

### **Abstract**

Research area administratively located in Kepahiang Regency, Bengkulu Province, Indonesia. Tectonic setting is situated between Musi and Ketaun segment of Sumatera fault. Eastern Ketaun segment occurred dilatational step over to Musi segment. The structural geology in this tectonic setting is of great interest as a research object.

Several methods was used in this study, which consist of remote sensing and fieldwork. Structural analysis using satellite imagery ASTER-GDEM was carried out in remote sensing. Structural analysis methods consist of digital lineament extraction, lineament density, lineament delineation, and statistic lineament. Fieldwork consists of surface geothermal manifestation mapping.

Digital extracted lineament shows structure orientation pattern. High density lineaments indicate areas with a main structure. The structural play consist of four main orientation, which are NW-SE, NNW-SSE, WNW-ESE and NE-SE. Structural trend NW-SE is associated with hot spring in Kelopak, structural trend NNW-SSE is associated with hot spring, fumarole and mud pool in Kaki Kaba and Air Sempiang, WNW-trend ESE is associated with hot spring in Suban, and structural trend NE-SW is associated with hot spring in Sindang Jati. These structures play an important role as discharge zones indicated by high density lineament areas and geothermal manifestation occurrence. The structural trend related to tensional regime of Musi and Ketaun segment of Sumatera Fault.

### **Keywords**

Sumatera Fault, Remote Sensing, Extracted Lineament, Structural Geology

---

## **1. Introduction**

### *1.1 Background*

Kepahiang geothermal prospect is situated in Sumatera fault system. Tectonically, it is situated between Musi and Ketaun segment of Sumatera fault. Eastern Ketaun segment occurred dilatational step over to Musi segment. Kaba stratovolcano is located between Musi and Ketaun segment. (Sieh and Natawidjadja, 2000). Surface geothermal manifestations indicate permeable zone and the existence of active subsurface geothermal system. This potential of geothermal system could be developed and utilized if we know whether it has potential. Generally in geothermal system we always search for permeable zones and high temperature systems because these are the most profitable

and able to generate more energy. This study utilizes remote sensing and manifestation distribution to establish the role of permeable geologic structure.

## 1.2 Study Area

Study area is in Kepahiang Regency, Bengkulu Province, which is geographically located between 224000-246700 mT and 9597000-9620600 mT.



Figure 1. study area

## 2. Geologic setting

### 2.1 Tectonic and Geologic Structures

Sumatra Island is the northwest oriented physiographic expression, lied on the western edge of Sundaland, a southern extension of the Eurasian Continental Plate. The Sumatra island is interpreted to be constructed by collision and suturing of discrete microcontinents in late Pre-Tertiary times (Pulunggono et al., 1992). Sumatra lies along the southwest margin of the Sunda Continental Plate at the western end of the Sunda Arc, beneath which oceanic crust is currently being obliquely subducted in a north-northeast direction (Hamilton, 1979)

Based on Darman and Sidi (2000) tectonically, Sumatra Island can be divided into 5 areas: outer-arc ridges; fore-arc basins; back-arc basins; Barisan Mountain; and intra-arc basins. Kepahiang is situated in Barisan Mountain, range that occurred along the Sumatra Fault.

Sumatra fault is divided into 19 segment with step overs. Most of the discontinuities are right steps in the fault trace and thus represent dilatational step overs. In figure 2, this research area is located in Musi and Ketaun segment. Southeastern end Ketaun segment is at 6 to 8 km wide dilatational step over onto the Musi segment. An inactive or less active continuation of the Ketaun segment may extend beneath the stratovolcano of Bukit Kaba (Sieh and Natawidjadja, 2000).

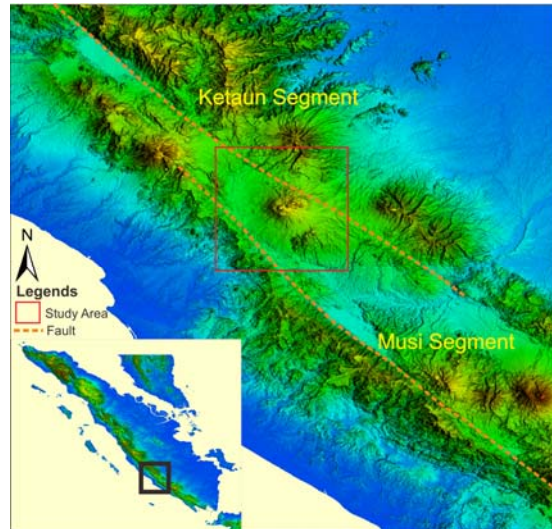

Figure 2. segmentation of Sumatera fault (modified Sieh and Natawidjadja, 2000)

## 2.2 Regional Geology

Stratigraphy of Kepahiang refers to Gafoer (1992) as follow:

- a. Hulusimpang Formation (Oligocene-Miocene): andesitic to basaltic lavas, volcanic breccia and altered tuffs.
- b. Seblat Formation (Oligocene-Miocene): Sandstone containing silicified wood, claystone, conglomeratic sandstone, limestone, shales, marl and tuffaceous with sandstone intercalation.
- c. Dioritic Intrusion (Miocene): dioritic intrusion
- d. Bal Formation (Miocene): dacitic epiclastic volcanic breccia with epiclastic volcanic sandstone intercalations.
- e. Rhio-Andesite volcanic rock Quarternary (Holocene): rhyolitic, dacitic, andesitic lavas, hybrid tuff, welded tuff, volcanic breccia and pumices.
- f. Andesitic-Basalt volcanic rock Quarternary (Holocene): andesitic to basaltic lavas, tuff and laharic breccia.
- g. Breccia volcanic rock Quarternary (Holocene): andesitic to basaltic, volcanic breccia, lavas and tuffs.

Summary of geological history in study area is described by Gafoer (1992). Increased activity with related magmatism in more recent times has resulted in the formation of the Tertiary to Recent volcanic arc of the Barisan Mountain, along the western edge of Sumatera, that is transected along its length by the Sumatera Fault System. Plio-Pleistocene tectonics produced important regional NW-SE structures evident throughout Sumatera. Volcanic activity in the Barisan Range throughout the Quarternary resulted in the formation of tuffs, lavas, and volcanic breccia of rhyolitic to basaltic composition. Regional geology map shown in figure 3.

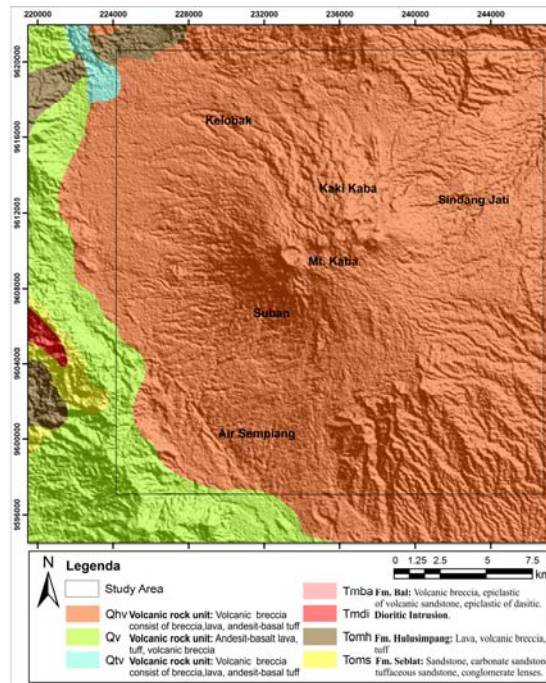

Figure 3. regional stratigraphy map of study area modified from (Gafoer, 1992)

### 3. Methodology

#### 3.1 Remote Sensing

Structural analysis using satellite imagery ASTER-GDEM was carried out in remote sensing. Structure analysis methods consist of digital lineament extraction, lineament density, lineament delineation, and statistic lineament.

##### 3.1.1 Digital lineament extraction

Digital lineament extraction was conducted using software programs with several parameters such as pixel filter radius, gradation edge limit, curve length limit, differential degree limit and error. The purpose of this analysis was to obtain pattern orientation and distributions based on those parameter. These parameters values were modified from Thannoun (2013).

Table 1. Extracted Lineament Parameter Values

Parameter	Value
Filter Radius	5
Edge Gradient Threshold	75
Curve Length Threshold	30
Line Fitting Error Threshold	10
Angular Different Threshold	20
Linking Distance Threshold	10

Digital elevation model cannot be represented from one slope orientation. Slope for a particular location is computed as the maximum rate of change of elevation between that location and its surroundings. Slope can be expressed either in degrees or as a percentage (Endyana, 2014). Aspect is the orientation of slope, measured from four relief illumination direction, where 0 is north-facing, 45 is northeast-facing, 90 is east-facing,

and 135 is southeast-facing. Hill shading is a technique used to visualize terrain as shaded relief.

### *3.1.2 Lineament density*

This analysis shows detail distribution and pattern of lineament in geothermal prospect area. Lineament density analysis was conducted to calculate the frequency of the lineaments per unit area (Hung et al., 2005; Thonnoun, 2013), and then produce a map showing concentrations of the lineaments over unit area. Base on Soengkono (1999), the lineament density is created by counting lines digitally per unit area (length/km<sup>2</sup>) and then plotted in the respective grid centers, contoured and be presented as lineament density. Lineament density method utilizes digital topography data and the shaded relief tool, which is available in GIS software. This method is useful for lineament analysis, not only the value of intensity but also pattern of fracture distribution and the main of direction of tectonic or volcanic style (Endyana, 2016).

### *3.1.3 Lineament delineation*

This method is utilized to delineate lineament based on extraction lineament pattern, lineament density anomaly and linear lower slope. Base on Endyana (2014) the step is to combine extracted digital from four illumination to produce delineation lineament, the combinations of the four extracted digital are computed by using GIS overlay technique. The linear feature which resulted from tectonic activity has a specific characteristic such as repetitive with arrange interval. Lineament delineation represent structural lineament in study area.

### *3.1.4 Statistical lineament*

The purpose of this analysis was to obtain the maxima from several sets of data and recover the spatial distribution of delineation lineament. Structure lineament is used to determine major trends of structure that exist in study area. Maxima of structural lineament were classified by sub drainage area.

## *3.2 Fieldwork*

Fieldwork consists of surface geothermal manifestation mapping. Manifestations here are hot spring, fumarole and mudpool. Fieldwork is done around Kepahiang Regency, some manifestations are located in Rejang Lebong Regency. Parameters described in surface manifestation mapping are manifestation type, coordinate, and elevation. Also lithological cross check and geomorphological survey.

## **4. Result and Discussion**

### *4.1 Structure Geology*

#### *4.1.1 Extracted Lineament*

The extracted lineaments show all possible linear features that can represent lineament pattern. Lineament patterns are used as a parameter to lineament delineation. In figure 4, four relief illumination directions showing different total lineament. 0° azimuth resulted 1702 extracted lineament, 45° azimuth resulted 1430 extracted lineament, 90° azimuth resulted 1242 extracted lineament and 135° azimuth resulted 1714 extracted lineament. Extracted lineament the 135° azimuth have higher number with compared with other.

Extracted lineaments from four illumination directions are overlaid to show integrated extracted lineament. This extracted lineament utilized for lineament density and delineation lineament analysis.

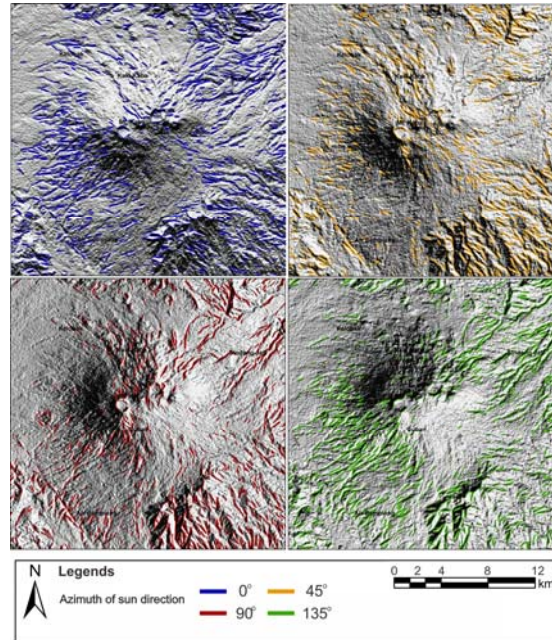

**Figure 4. Extraction Digital Lineament**

#### *4.1.2 Lineament density*

Lineaments density map of lineaments from four directions is produced and shows in figure 5. Lineament density map is created by counting lines digitally per unit area (length/km<sup>2</sup>) and then plotted in the respective grid centers and contoured. The high density of lineaments are located in the areas indicated as a main structure. High anomaly lineament density shows by yellow and red contour, with density value 2400-1600 m/km<sup>2</sup>. These lineament may be caused by tectonic activity. These delineation lineaments with the parameter of lineament density are very important for knowing structural geology.

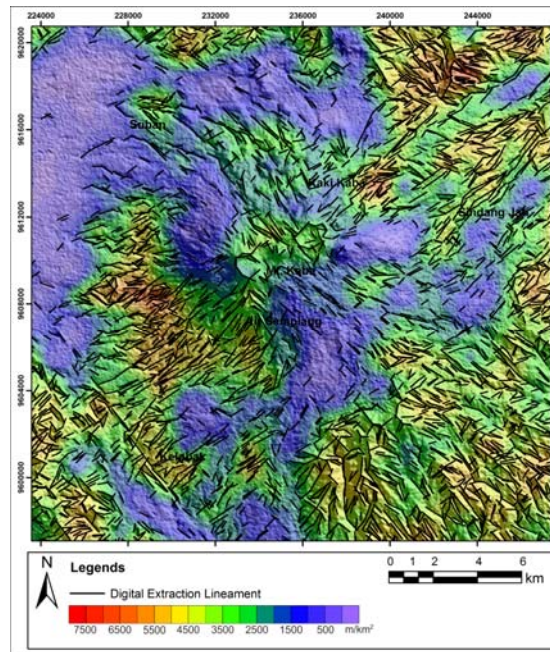

Figure 5. extraction digital lineament density

#### 4.1.3 Structural Lineament

Delineation lineament resulted structural lineament based on extracted lineament pattern, lineament density anomaly, and linear lower slope. Statistical lineaments are analysis structural lineament trend. Structural lineament maxima were classified by sub drainage area. Structural lineament rose diagram shows 3 dominant lineament trends, these are NW-SE, WNW-ESE and NE-SW. Structural lineament trend NW-SE shows in Kepahiang sub drainage area C dan D, WNW-ESE shows in sub drainage area A, and NE-SW shows in sub drainage area B.

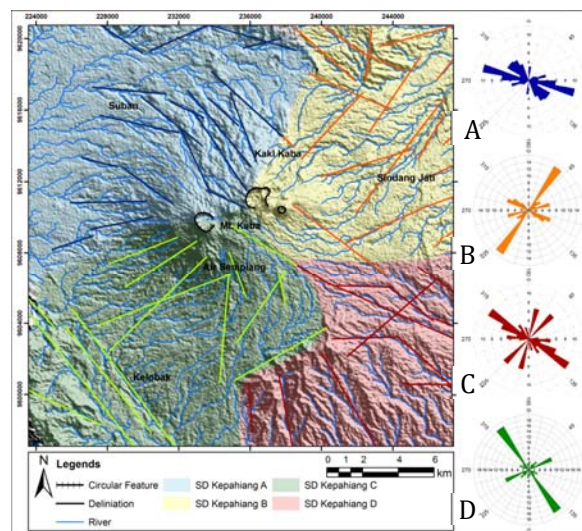

Figure 6. structural lineament trend

Type of structural lineament determination uses *shear strain* concept from Riedel (1926) dan Harding (1985), described in Allmendinger (1999). In figure 7, based on Riedel (1926) structural lineament NW-SE trend associated with Ketaun and Musi segmen fault of Sumatera, this structural lineament is main structure, NNW-SSE trend



associated with R-shear (synthetic fault), NE-SW trend associated with R'-shear (antithetic fault), and WNW-ESE trend associated with P-Shear (secondary antithetic fault).

Base on Harding, et al. (1985) structural lineament trend NW-SE is associated with PDZ (*Principal Displacement Zone*) of Sumatera fault system, NNW-SSE trend is associated with an echelon synthetic fault, and NE-SW trend is associated with *en echelon antithetic fault*.

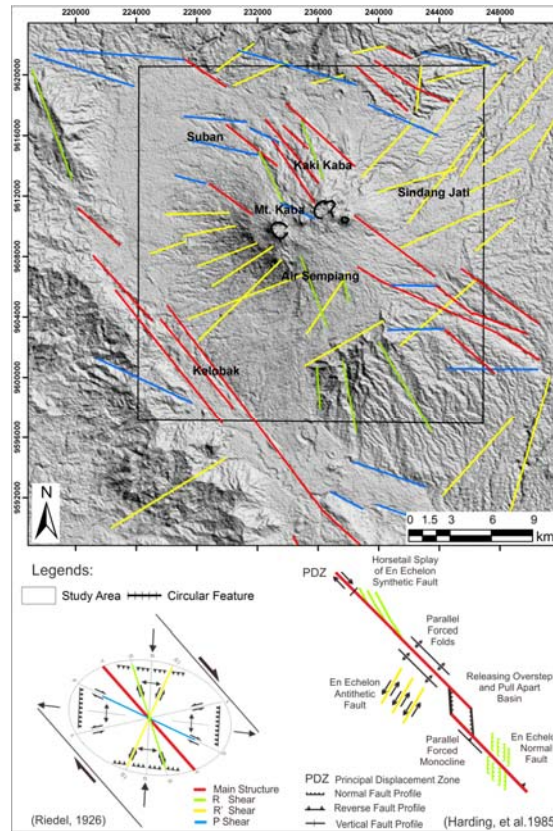

Figure 7 structural lineament type

#### 4.2 Manifestation

Surface geothermal manifestations indicate the existence of active subsurface geothermal system. Geothermal manifestations are commonly associated with geological structures. Several geothermal surface manifestations found, which consist of hot springs, mud pool, fumarole, and solfatara.

Manifestation associated with four structural trend, there is NW-SE trend associated with hot spring in Kelobak, NNW-SSE trend associated with hot spring, mud pool and fumarole in Kaki Kaba and Air Sempiang, WNW-ESE trend associated with hot spring in Suban, and structural trend NE-SW associated with hot spring in Sindang Jati.

This structural play is believed to have an important role as discharge zones indicated by geothermal manifestation occurrences. The structural trend is related to tensional regime of Musi and Ketaun segment of Sumatera Fault.

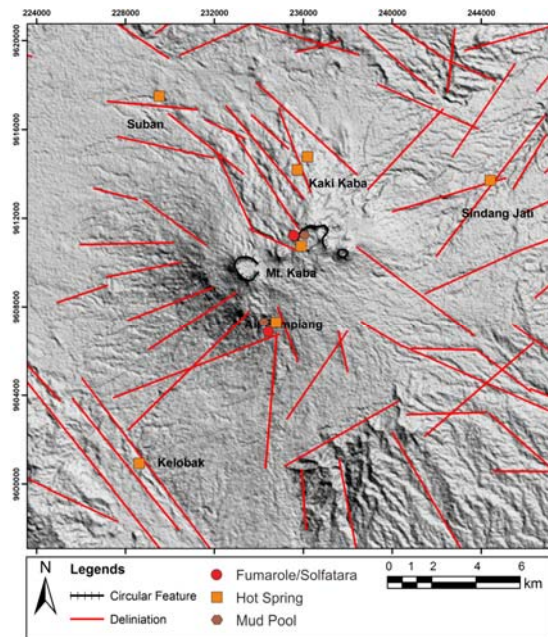

Figure 8. geothermal manifestation

## 5. Conclusion

The extracted lineaments represent linear lineament patterns and distributions. The high densities of lineaments are located in the areas indicated as a main structure. Lineament delineation analysis is utilized to determine the structural geology in the surface study area. Structural plays trending NW-SE, NNW-SSE, WNW-ESE and NE-SW play an important role as discharge zone. Lineament distributions and patterns are important parameters for permeable zones indicated by geothermal occurrence. The structural trend is believed to be related to the tensional regime of Musi and Ketaun segment of Sumatera fault.

## References

- Book:** Allmendinger, R.W. (1999). Introduction to Structural Geology. Ithaca: Cornell University. P. 33-45.
- Book:** Darman, H., and Sidi, F. H. (2000). An Outline of the Geology of Indonesia, Indonesian Association of Geologists. Jakarta: Ikatan Ahli Geologi Indonesia.
- Conference paper:** Endyana, Cipta et al. (2016). Controlling Groudwater System by Pattern Fracture Approach in Subsurface Volcanic Deposit: Mt.Salak-Mt.Pangrango, West Java, Indonesia. Intenational Symposium on Geophysical Issues, IOP Conference Series: Earth and Enviermental Science 29.
- Conference paper:** Endyana, Cipta et al. (2014). Fracture Pattern Controlled Groundwater Flow in Volcanic System Case Study in Ciharang, West Java, Indonesia. The International Seminar on Chemistry (ISC) of Universitas Padjadjaran.
- Book chapter:** Gafoer, et al. (1992). Regional Geology Map of Bengkulu Quadrangle, Sumatera. Geology Research and Development Centre: Bandung
- Conference paper:** Hamilton, W. (1979). Tectonics of the Indonesian Region. U.S. Geological Survey Professional Paper 1078: Washington, United States Government Printing Office.
- Conference paper:** Pulunggono, A., Haryo. A.S., Kosuma. C.G. (1992). Pre-Tertiary and Tertiary fault system as a framework of the south Sumatera Basin: a study of Sar maps Indonesia. Proceedings of 21th IPA Annual Convention, p. 339-360.
- Conference paper:** Sieh, K., Natawidjaja, D.H. (2000). Neotectonics of the Sumatran fault. Journal of Geophysical Research. p.28,295-28,326.

- Conference paper:** Soengkono, S. (1999). Analysis of digital topographic data for exploration and assessment of geothermal system. Proceeding 21st New Zealand Geothermal Workshop. p. 163-166.
- Journal Article:** Thannoun, R.G. (2013). Automatic Extraction and Geospatial Analysis of Lineaments and their Tectonic Significance in some areas of Northern Iraq using Remote Sensing Techniques and GIS. International Journal of Enhanced Research in Science Technology & Engineering Bulletin. Vol. 2.

**Optimalization of the Planning Area in Using Infrastructure  
Development Impact of the Petroleum and Palm Oil Industry  
in Minas District, Riau Province**

Puji Astuti, Ryanda Prima

*Islamic University of Riau, Kaharuddin Nasution #113, Pekanbaru 28284, Indonesia*

---

**Abstract**

*The impact of the petroleum and palm oil industry is driving factor to develop Minas District. Government and community give attention to exploit it in accordance to potential existing of the region. The problem is low utilization arises multiplier effect, infrastructure concentrated in the industrial area, economic agglomeration problem between industrial and community area, disparities distribution of infrastructure between villages in Minas District. The purpose of this research is develop concepts and strategies for optimalization of infrastructure in the Minas District to exploit multiplier effect of the petroleum and palm oil industry. This study uses facility and utility analysis, identification of industry impact, and scoring analysis.*

*Minas District has function and role as Strategic Economic Zone based on utilization of oil and gas resources. Physical carrying capacity of the area significantly in good condition, support of adequate infrastructure. The potential existence of the industry have a positive impact on the economic and physical development. While the negative impact of industrial produce pollution of water, soil and air. Spillovers from industrial activity is concentrated in several areas in direct contact to the industry area. Analysis of scoring against infrastructure priorities shows that drainage and water supply is the main priority in the area, roads at second priority and the third priority is electricity. Based on analysis, development concept of Minas District is infrastructure optimalization of petroleum and palm oil industry activities.*

**Keywords**

Palm Oil; Petroleum; Infrastructure; Industrial Area; Disparities

---

**1. Introduction**

Minas District has potential prospective industrial area in Siak. International petroleum industry Chevron Pacific Indonesia is one of the major industries located in Minas District, and the spread of palm oil plantations nationwide along with its processing plant is also located in this region. In addition, Minas District has a very strategic location, is the gateway Pekanbaru-Medan so that the development of trade and services sector is also growing rapidly. The effects of these industrial activities influence for Minas District itself and the surrounding community, especially the growth of economic activities. The effect given by industry is expected to provide the major impetus for the growth of Minas District in social, economic, and physical.

The industrial activities require the construction of infrastructure to distribute the results of the activities of the petroleum industry and palm oil, as well as for employees who live in the industrial area. However, there are problems related to infrastructure in the industrial area if it is associated with the District of Minas and surrounding areas:

1. Not optimal utilization of the positive impact of industrial activity  
Activities of international oil and gas industry in Minas District can provide of economic growth for Minas District in order to grow rapidly from other districts. However this can not be utilized by the local government for the utilization of resources and the potential that exists in the region. While the oil and gas industry itself can provide economic value to changes in Minas District and provide a positive multiplier effect for the surrounding region.
2. Infrastructure is concentrated around industrial region  
Infrastructure located in the District of Minas is just being in the neighborhood - a particular region, especially commonly found around the industrial area. This causes uneven deployment of infrastructure so that only part of the area that can develop well. While the region is far from an industrial area not covered by the infrastructure.
3. The occurrence of the economic disparities between the industrial area and communities around the industrial area.  
This occurs because the economy of the population in the industrial area better than economies that are outside the industry. From the physical (roads, drainage, electricity, water), the infrastructure needs of the population in the industrial area more in priority. This is the cause of economic inequality that is striking, so the industry does not take effect on the economic development of the communities around the industrial area.
4. Distribution of facilities and infrastructure between villages in the District of Minas uneven.  
Inequitable distribution of the type and quality of facilities between the villages resulted in impaired development of the physical activity of the population, economic and social. This should be a concern of local government so that inequality is not deep. Infrastructure that resides in the industrial area of higher quality than the surrounding areas.

## **2. Infrastructure and Regional Development**

Infrastructure has a positive effect on economic growth, social and cultural. In the short term infrastructure development creates construction and non-construction sector. In the medium and long term infrastructure will support increased efficiency and productivity related sectors. Infrastructure can be the answer to the region that want to encourage economic growth, social and cultural. Because of the availability of infrastructure can help reduce poverty, improve quality of life, support economic growth centers and increase the mobility of goods and services and lower the cost of the activity of domestic and foreign investors.

The concept developed from the regional development needs an area to improve the function and its role in managing the social, economic, cultural, educational and social welfare. The influence of globalization, free markets and regionalization leads to changes and spatial dynamics, social, and economic interstate, regional (city / county), districts and rural areas. The impact of globalization has caused the boundary between urban and rural areas have become blurred, the polarization of regional development,

municipal systems on an international scale, the formation of interstate construction area (transborder regions), and the formation of regional development corridors both locally, nationally, regionally and internationally.

Infrastructure development has a very important role in supporting economic activity, social, cultural, as well as the unity and integrity of the nation, especially as the capital base to facilitate interaction and communication among groups of people as well as binding and connecting regions. Infrastructure development, which is the unity of the national development, is expected to drive the growth of the national economy and supporting national competitiveness globally. Infrastructure support to national economic growth is mainly manifested in the role of the transport network, communications and informatics which allow people, goods and services moving from one place to another and exchange information quickly. In addition, support facilities and infrastructure are also embodied in the role of water resources, electricity, and housing and settlements that became an integral part of community life. It is also an important input in the production process of economic sectors such as trade, industry, and agriculture.

In order to provide the facilities and services of quality infrastructure, the government has made every effort in good shape with the setting regulatory policy framework and investment policy framework, through the rehabilitation of damaged infrastructure services capacity and increase service capacity through new development. expected availability of facilities and infrastructure services can be improved. However, the high public demand for infrastructure is still constrained by the limited capacity of government financing. As a result of inequality, the Government encourages private sector participation in infrastructure development through cooperation scheme between the government and private sector partnership promoting the principle of a fair, open, transparent, competitive, and mutual benefit.

Beneficial cooperation between private and government, will generate a planning concept, namely sustainable development planning (Sustainable Development). Sustainable development is an attempt to meet the needs of the present without compromising the ability of future generations to meet their needs.

### **3. Material and Methods**

The purpose of this study was to develop a program plan optimization of infrastructure in Minas District to leverage the impact of the petroleum industry and the palm, with the steps: identifying existing infrastructure, identifying policies and the development of industrial management oil and gas, and plan optimization program infrastructure of industrial activity in the district of Minas-based industries. The scope of the research includes the preparation of planning reports:

1. Identify the problems of implementation of regional development studies  
Identifying the existing problems of implementation of development at this time, with the search for solutions and equitable development strategic plan that fits perfectly with the potential of natural resources and existing technology.
2. Estimated requirements for regional development implementation study  
Estimates or projections of the development needs of the region in the future, by knowing the amount of infrastructure required to use scoring analysis.
3. Analysis and drafting; analysis of the area that will be developed and assembles the right concept that can support the analysis to be planned with some aspects and other supporting sectors.
4. Conduct analysis of facilities and infrastructure needs

5. Develop infrastructure optimization plan due to the impact of industrial activities and palm oil in the District of Minas.

#### **4. Results and Discussion**

Subdistrict Minas is an area with the most extensive plantations in Siak. The main commodity plantation sector in Siak district consists of rubber, coconut, palm, areca, pepper and hazelnut. Among the commodities, oil palm plantation sector dominates production with an upward trend. The rapid economic development in the District of Minas mostly in the plantation sector, namely oil palm plantations. This shows shows a significant increase of sector income generating economic growth in major capital for the economic development of the District Minas.

The highest land use in Minas District is plantation 42594.21 ha (61.23%) and forest 13031.31 ha (18.73%). While the oil area is 433.80 ha (0.62%) and the residential area is 792.54 ha (1.14%). Plantation is the largest land area in the District of Minas. Nearly 62% of the total area of the Minas District types largest oil palm plantations. In addition there is a small scale rubber plantations, areca, pepper and hazelnut.

The topography of the Minas District is hilly, it is quite difficult in the development of Minas. Due to the topography of the hilly city, especially the pattern of development of settlement takes place in enclaves in the flat area between the hills. The area of all villages in the District of Minas around 69559.96 hectares.

Minas region is an area of oil and gas mining longest since 1960 until today. As the oil concession area, the results of the oil city of Minas became the largest contributor to the National Budget. Since the Minas Districts developed into a city with growing support facilities for the oil region. So until now, the market is growing Minas more than the other villages in Minas District. This is because the business district close to the oil fields (managed by PT Chevron).

In accordance with the vision of the corridor arrangement of Minas District that position as a gateway and a haven environmentally sound also be promoted Local Events Center. From this vision proves that Minas is good enough to be developed in any sector that can be used as a promotion out of the area as a large capital investment and to increase input and appeal of the Minas District. Its directed to the development and consolidation of functions and roles of Minas as the Strategic Economic Region in Siak based utilization of oil and gas resources.

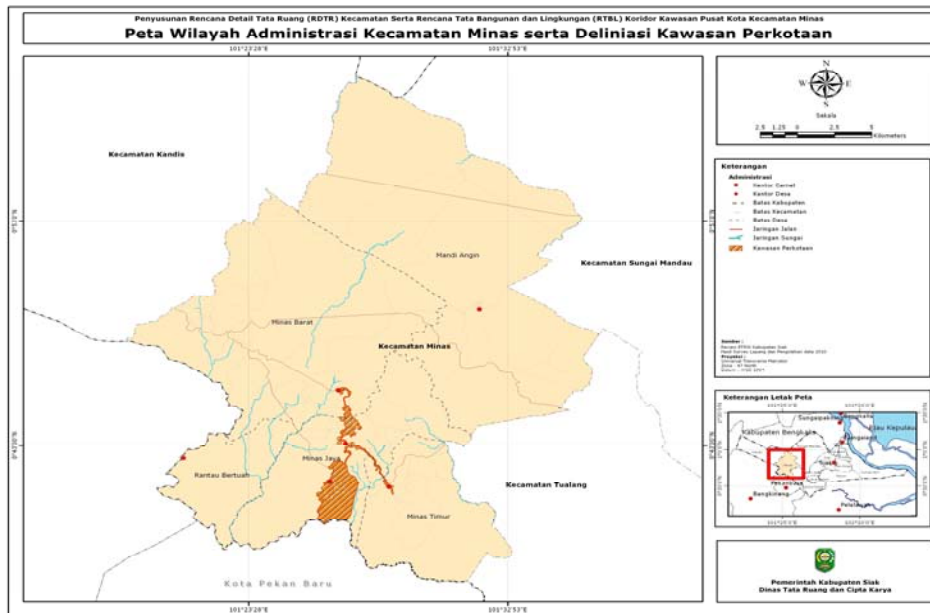

Figure 1. Map of the District Administration Minas  
(Source: RDTR District of Minas, 2010)

#### 4.2. *Potensial and Problems*

The development of oil and gas industry in Minas District will have an impact for the development of the region. Also with the movement of human activities, population growth in line abreast and influence multiplier effect arising from the industrial activity. This has attracted the emergence of regional growth in terms of the economy such as trade and services, housing, human resources (professionals reliable and quality) as well as the technology is increasingly modern and adequate infrastructure.

While the current conditions influence multiplier effect arising from the industry, when viewed in terms of quantity and condition of the building and distribution facilities and infrastructure in the district of Minas currently not so perceived the surrounding community. Facilities and infrastructure are there still very low, even far from the reach of services and the city center. Unspoiled villages and did not feel the effect of the multiplier effect of the industry. The government is difficult to provide services and anticipation of distribution facilities and infrastructure disparities between villages, the government hard to harness the influence multiplier effect caused by the industry. To anticipate the problems of infrastructure that is not optimal and the disparity in the distribution infrastructure of each village different apparatus, takes the role of the private sector to also take part in the construction and development of the region.

The existence of an industry in a region will always have an impact on the region, both negative and positive impacts. Also Minas District is identical to the petroleum industry which is on the Minas District, and several national scale industries engaged in the processing of palm oil. It certainly should be a special assessment for the District of Minas to reap the benefits with it, especially the potential that can be exploited, but the things that are harmful or new problems that arise with the industrial area of the Minas District also be examined. Here are the potential and problems that can arise:



Table 1. Potential and Problems Industrial Activities of Petroleum and Palm Oil in Minas District

Potential		Problems	
1.	Increase the income of the population thereby increasing prosperity	1.	Industrial waste will cause contamination of water, soil and air
2.	Industry will produce goods needed by society	2.	Factory smoke can cause air pollution
3.	Industrial raw materials increase the utility value	3.	With the pollution would damage the ecosystem of animals and plants that exist.
4.	Expanding employment	4.	Not a positive impact on the local industry in the Minas District, both small and medium industries
5.	stimulate people's knowledge of the industry	5.	This happens because there is no connection between big, medium, and small, due to the industry from the foreign party usually brings with supporting industry so that the production process from upstream to downstream controlled by the industry of the area in terms of the District Minas

Source: Result of Analysis, 2013

### 4.3. Theories of Industrial Relations with Industry Analysis

To support development plans in the District of Minas are many theories as needed basis runway. So that the development plans in the District of Minas have the strong theoretical basis, here are some of the theories used in this study and the results of the analysis of the use of the theory of the study area:

Table 2. Relationship Theories Industry by Industry Analysis Results

Theory	Material	Result of Analysis
Theory of Weber	a. Raw Material Based on the triangular theory of Weber, a manufacturer will determine the location of the plant in a location that can provide optimal benefit.	Applicable to industrial activities in Minas, seen all the existing industries in the District of Minas closer to the source of raw materials. For example, Chevron makes oil refinery in the District of Minas which has oil reserves in order to get closer to the raw materials and reduce the cost of production.
	b. Labor In general, manufacturers are more like workers coming from the area around the industrial site. Transport costs incurred for labor in the factory is cheaper, so the workers were not demanding wages that are too high.	The location of the existing petroleum industry is at the center of District of Minas, Minas Jaya, that the population is large and the location of Minas Jaya village close to the raw material as well as close to the Pekanbaru City. This is considering that labor yang obtained are people around and close to the office accommodation to reduce the cost of labor
	c. Accessibility Accessibility to spur the process of interaction between the regions up to the most remote areas so as to create equitable development. The smaller the transportation costs between the location of raw materials to the plant and the location of the total marketing costs are also getting smaller	The location of the existing petroleum industry is at a cross roads Pekanbaru-Minas-Duri-Dumai, making the level of accessibility of this industry to achieve high Dumai port as the port of loading unloading petroleum and palm oil, and returned to reduce the cost of production.
Effect of Industrial Area	Some things that can be harnessed from the regional industry with regard to the amount and location of industrial areas that could produce certain effects for the surrounding region, which could be directed	Based on the theory of the influence of industrial zones, industrial areas can provide a certain impact and can be directed, the impact of the oil and gas industry in the District of Minas is the multiplier effects that influence the development of Minas Districts, which is based on the hypothesis is not maximized use was in the construction of infrastructure facilities in the District of Minas

Source: Result of Analysis, 2013

#### 4.4. Impact Analysis of Industrial Activity

Analysis of the impact of industrial activity was conducted to determine the outcomes rather than activities of the petroleum industry and palm oil in the District of Minas.

Table 3. Relationship Theory with Industrial Activity Impact Analysis Results

Theory	Material	Result of Analysis
Theory of Multiplier Effect	According Supriyadi (2007) multiplier effect is an activity that can affect and influence the state of the surrounding area indirectly, as a result of factors urge to evolve and grow into an area that can be taken into account.	Industrial activity in the District of Minas has given effect to the development of the Minas District, the density and undeveloped land around the location of the industry that triggered the development of the surrounding development.
	The various advantages of the Strategic Industrial Zone on the economy of the region is: a. Promote growth and development of the region b. Attract investors to invest District / City. c. Enhance the development and welfare of the community d. Attract more business opportunities to be developed, especially in the sectors of industry and trade and services. e. Increase revenue and economic Regency/City f. Increase of Community Development Index and unit community activities	Multiplier effects resulting activity of the industry that makes the central District of Minas into a rapidly growing, people become more prosperous, the opportunity to open a business, it can make rapid development, but there are other things caused by the multiplier effect is concentrated in Central District of Minas course that disparity development others are nearby that is not affordable multiplier effect.
Disparity Theory	Factors that cause the imbalance of economic development: a. Concentration of Regional Economic Activity b. Investment allocation c. The level of mobility of factors of production lower d. The difference of resources between regions e. Demographic differences between regions f. Inhibition of trade between regions	Multiplier effects of the existing center of the District Minas create economic activity centered in the village of Minas Jaya, one of the factors of production, namely population mobility is low in the District of Minas, and natural resources are different in every region of the village in the district of Minas also give the impression of a gap in the District of Minas
Externalities Theory	Externalities can be positive or negative. Positive externalities occur when the activities performed by a person or group to provide benefits to individuals or other groups. The negative externality occurs when activities by individuals or groups produce harmful effects for others.	Externalities divided into two negative and positive impact of the negative externalities petroleum and palm oil is the impact of environmental pollution which becomes damaged as a result of mining activities, the development of strategic land District of Minas becomes narrower with the concession of Chevron. The resulting positive externalities is, the development center district town of Minas becomes rapid, earnings and variations in population into diverse professions and others.

Source: Result of Analysis, 2013

#### 4.5. Scoring Analysis

To maximize the positive impact of industrial activities in the District of Minas in the field of development of infrastructure necessary to study development priorities to determine the infrastructure that will be built first. For that analysis using the scoring method used to determine the priority of infrastructure to be built.

Table 4. Score Calculation of Facilities

No	Facilities	Range	Score	Function Roads	Score	Building Condition	Score	Total Population	Score	Availability of Land	Score	Quantity	Score
1	Education	Far	15	Arteries	15	Medium	15	1000-3000	10	Considerable	15	Deficient	20
2	Health	Near	8	Local	10	Not good	20	>3000	8	Considerable	15	Deficient	15
3	Worship	Far	8	Colector	8	Good	10	<1000	15	Considerable	15	Adequate	10
4	Economic	Near	15	Arteries	15	Medium	15	>3000	8	Adequate	10	Deficient	15
5	Green Open Spaces	Far	8	Colector	8	Good	10	>3000	8	Considerable	15	Adequate	10

Source: Result of Analysis, 2013

Table 5. Score Calculation of Infrastructure

No	Infrastructure	Physical Condition	Score	Availability of Land	Score	Quantity	Score	Level of Requirements	Score
1	Roads	Not Good	25	Considerable	25	Deficient	15	Butuh	30
2	Drainage	Good	25	Considerable	25	Deficient	20	Butuh	30
3	Electricity	Good	15	Considerable	25	Adequate	10	Kurang	25
4	Waste	Medium	20	Adequate	20	Deficient	15	Kurang	25
5	Clean Water	Not Good	25	Considerable	25	Deficient	20	Butuh	30

Source: Result of Analysis, 2013

Based on analysis of scoring to determine infrastructure priorities to be built in the District of Minas in order to maximize the impact of the petroleum industry and palm oil then showed the following results:

1. Development of facilities priority are:
  - Education Facility = First Priority
  - Health and Economics = Second Priority
  - Worship Facility and Green Open Space = Third Priority
2. Infrastructure Development priority is:
  - Drainage and Clean Water = First Priority
  - Waste and Roads = Second Priority
  - Electricity = Third Priority

#### 4.6. The Concept and Development Strategy District of Minas

To plan and develop the District of Minas by optimizing the infrastructure due to the impact of industrial activities of petroleum and palm oil takes the concept of development that Infrastructure Optimization of Petroleum and Palm Oil Industrial Activity. The strategies that must be done is :

1. Provide and improve the completeness of educational facilities and economic activities that bring no commercial value and is able to meet the needs of the community and migrants as well as get the attraction for investors.
2. Increased growth of urbanization as a result of the construction of facilities and infrastructure that support in a region
3. Improving road accessibility to the location of health and education services as a result of industrial activities, supported by adequate infrastructure that creates mobility of the population and the economic and social welfare.
4. Increase Index Community Development and Community Work Unit thus increasing employment opportunities, thus eliminating unemployment.
5. Maximizing transport node and oil drilling were able to attract economic activity and create economic strategic area of Minas District.

6. Increase the role of the community in improving the quality of services and infrastructure to improve the capability of human resources
7. Attractive other business opportunities to be developed, especially in the sectors of industry and trade and services
8. Maintain the characteristics of the regional potential, namely the potential of petroleum, palm oil, mix use of economic activity (trade and services) and land use (location Perawang strategic path intersection and main corridors cross Pekanbaru - Medan) which can be an attraction and uniqueness of the District of Minas to bring investors and income for Minas District.
9. Using human resources qualified to provide expert reliable and equipped with science and technology so as to create the modern technology.

## 5. Conclusion

Based on the research are:

1. There are positive impacts and negative impacts of the activities of the petroleum industry and oil palm processing to the District of Minas.
2. The educational facilities and clean water is a top priority community needs in Minas District.
3. The concept of the development of the District of Minas is the optimization of the infrastructure of the activities of the petroleum industry and palm oil processing.

## References

- Adisamita, Rahardjo. (2010). *Pembangunan Kawasan dan Tata Ruang*. Graha Ilmu, Yogyakarta.
- Astuti, P. and Maisaroh, L. (2013). *Prospectivity of Ro-Ro Dumai Cross Harbour for Physical and Economic Sector at Kelurahan Pangkalan Sesai Kecamatan Dumai Barat*. In *Proceeding of the 2<sup>nd</sup> International Conference on Regional Development*, Diponegoro University, Semarang.
- Djojodipuro, Marsudi. (1992). *Teori Lokasi*. Lembaga Penerbit Fakultas Ekonomi Universitas Indonesia, Jakarta.
- Eriawan, T. and Tou, H. J. (2010). *Perencanaan Wilayah*. Universitas Bung Hatta, Padang.
- Irawan and Suparmoko, M. (1992). *Ekonomika Pembangunan*. BPFE, Yogyakarta.
- Mulyanto. (2006). *Prinsip-Prinsip Pengembangan Wilayah*. Graha Ilmu, Yogyakarta.
- Nurzaman, Siti S. (2012). *Perencanaan Wilayah dalam Konteks Indonesia*. Penerbit ITB, Bandung.
- Rustiadi, Ernan, et al. (2009). *Perencanaan dan Pengembangan Wilayah*. Yayasan Obor Indonesia, Jakarta.
- Sadyohutomo, Mulyono. (2009). *Manajemen Kota dan Wilayah, Realita dan Tantangan*. Bumi Aksara, Jakarta.
- Susanto, A.B, et al. (2010). *Reinvensi Pembangunan Ekonomi Daerah, Bagaimana Membangun Kesejahteraan Daerah*. Erlangga, Jakarta.
- Tarigan, R. (2005). *Perencanaan Pembangunan Wilayah*. Bumi Aksara, Jakarta.
- Warpani, Suwardjoko. (1980). *Analisa Kota dan Daerah*. Penerbit ITB, Bandung.

---

## **Determining Equation of Oil Rate Prediction by Statistically Analysis Function in New Productive Zone**

<sup>1</sup>Ira Herawati, <sup>2</sup>Novia Rita, <sup>2</sup>Novrianti, <sup>2</sup>Rosalia M Taufand

<sup>1</sup>Petroleum Department, Faculty of Engineering, Islamic University of Riau, Riau, 28284, Indonesia

---

### **Abstract**

Oil rate will be decline at production time in a well. So, we have to produce in another layer who assume have a potential. Before we produce another layer who assumed have a potential, we need to predict oil rate to known how much oil gain. In this field research oil rate prediction in new productive zone was determine following by analogical data and near well references. In this method there is a difference determine of oil rate for each people. Cause of that, in this research using analysis statistical for oil rate predicting in new productive zone based on linear function for Productivity Index (PI) and polynomial function for watercut. Determining equation of linear and polynomial functions for oil rate prediction measuring by production and logging data for each well who assumed productive zone in area X field RMT. Based of statistically analysis for linear function known that coefficient determination ( $r^2$ ) = 0.9964 and polynomial function known that coefficient determination ( $r^2$ ) = 0.9993. This result indicated that we can use both of the functions for oil rate prediction in new productive zone in area X field RMT. After that, based on both of functions calculate oil rate prediction each wells in area X field RMT. So, known differences in oil rate prediction between oil rate data in area X field Y known is 28.13 BOPD or 0.78%

### **Keywords :**

Oil Rate, Statistical Analysis, Coefficient Determination , Productivity Index, Watercut

---

## **1. Introduction**

The decline of oil flow rate in an oil field becomes a problem that have to be faced during the production period. One of several ways to solve the declining oil flow rate problem is by producing a new zone. Previously, oil flow rate determination in the new zone that have not been producing at a potential reservoir is determined from the logging data and wells near by reference. This method focuses on the analogy of the existing data. By using these methods, several parameters that become the benchmark of oil flow rate estimation have an uncertainty factor. In this case, everyone has the different determination of an oil flow rate with the same parameters. It makes this research needs to be done to determine that uncertainty factor. Potential reservoir which is the becomes the object in this research shall be referred to the productive zone.

Productive zone in this study is the layer that has never been in produces by a well, so it becomes a backup for the well. This occurs because the well was still quite good producing from another layer or from wells that are still relatively new, so there

are certain zone that has never been produced. When production wells down then, can be done to increase production by opening new layers that are considered productive.

In the case of management and these issues, it is often found some forecasting activity, prediction, estimation and more. One method that can be used to solve the problem is statistical methods. The use of statistical methods are very dependent on the structure of the data or the number of variables. One of the methods that is used for one variable or more than one variable is the regression analysis.

Regression analysis is a statistical methodology to predict the value of one or more response variables (*variable dependen*) from the collection of predictor variable value (*variable independen*). This analysis can also be used to predict or forecast the effect of the predictor variable (independent variable) on the response. In regression analysis, it is learned how these variables relate and expressed in a mathematical function. This research is done by using regression analysis, to determine the function representing the approximate flow rate of oil in the productive zone.

The objective of this paper is to determine the coefficients and function of linear regression of the permeability and thickness of the perforation of the Productivity Index and regression function at the polynomial correlation to the water saturation of the Watercut. At the end we could estimate the flow rate of the oil in the productive zone using a regression function and evaluation of oil flow rate estimates based on the function of the oil flow rate based on the data.

## **2. Material and Methods**

Productive zone in this study is a new zone that has not been produced and has potential if seen from the data logging. This study uses data of each well log consisting of log GR (Gamma Ray), log SP (Spontaneous Potential), caliper logs, resistivity logs, neutron and density logs. Based on the GR deflection curve at minimum value, indicates that the area with the curve approaching the minimum value may be a reservoir layer because of the nonshale (permeable) rock type which in this case, the sandstone type, the reservoir rock type in general. Meanwhile, if the deflection curve leads to a maximum value then the rock type may be shale (impermeable).

On the log resistivity deflection curve with a great value indicates the potential for hydrocarbons contained therein, on the contrary if the deflection curve with a small resistivity values indicates the potential non-hydrocarbon (water zone). From the results of neutron log that has a deflection at a great value, it can be seen that these rocks have a large porosity. In the productive reservoir layers, the neutron-density log curves will intersect and form of separation. This indicates the exist of permeable layer and a reservoir layer. This both curves show the formation of separation column (cross over).

The small cross over indicates the type of fluid is oil. At the gas zone, these two curves show the formation of the separation column. A large cross over, gas zone is also characterized by neutron porosity price that is far less than the price of porosity, so it would show the existence of a larger separation.

In this research, to determine the flow rate of oil in the productive zone, it would require some data from wells located in an area that is not separated by any fault (fault). A layer of sand that is used as data in this study is the same sand layer. This is done because the consideration of the physical properties of rock and fluid at the same sand

tends not much different when compared to the physical properties of fluids and rocks on different sand.

In areas 1 and 3 there are 614 wells candidates which are productive zones that have been produced. However, this research is limited to areas that are not separated by their fault, so the area that it is included into non-separated by fault area is area 1 with focus area 1, 2, 3 and area 3 with focus area 5 there are only 104 wells. After determining the candidate wells that are included in the areas relevant to the objectives of this study, furthermore, pick the same sand layer seen in a predetermined area. In this study, A-1 sand layer chosed.

Of the 104 wells which are reviewed there were 21 wells that have a productive zone A-1. Furthermore in this study, the 21 well candidates is reviewed as productive zones to estimate the oil flow rate. Permeability and saturation data in the productive zone which is used as a candidate in this research was determined from logging data to the log attached. While the thickness of the zone productive in this study is the interval thickness of each well perforations known by looking at the production history of candidate wells which is about to be examined and retrieve perforation data (Top perforation and bottom perforation), the watercut data and production flow rate on the candidate wells in this research

### 3. Result and Discussion

Calculations of Permeability, Saturation and Resistivity Well RMT-01 is done by the sameway to each well. Result of PI calculation as shown at table 1.

Table 1. Result of PI Calculation

Well	K (md)	$h_{\text{perfo}}$ (ft)	$K \cdot h_p$	$r_e$ (ft)	WC (%)	$\mu$ (cp)	PG (psi/ft)	PI (STB/D/psi)
RMT-01	499	10	4990	393.29	97.2	0.36512	0.3651	14.29
RMT-02	752	6	13320	274.39	93.22	0.42356	0.4236	34.81
RMT-03	1849	3	5547	417.68	96.7	0.37246	0.3725	15.43
RMT-04	4370	2	8740	533.54	96.3	0.37833	0.3783	23.07
RMT-05	2102	8	16816	554.88	98	0.35337	0.3534	47.26
RMT-06	2403	8	19224	481.71	97.23	0.36468	0.3647	53.46
RMT-07	810	8	6480	295.73	95.8	0.38568	0.3857	18.37
RMT-08	3721	5	18605	554.88	98.4	0.3475	0.3475	53.17
RMT-09	1770	2	3540	609.76	98.7	0.34309	0.3431	15.82
RMT-10	3322	12	39864	442.07	98.03	0.35293	0.3529	116.02
RMT-11	1243	3	29820	329.27	99.68	0.32877	0.3288	97.5
RMT-12	1404	10	14040	204.27	93.92	0.41333	0.4133	39.49
RMT-13	6167	3	18501	375	98.7	0.34309	0.3431	56.8
RMT-14	751	14	10514	554.88	96.6	0.37393	0.3739	27.93

RMT-15	1166	6	3708	480.18	91.9	0.44295	0.4429	8.49
RMT-16	2210	6	2352	161.59	83.47	0.56674	0.5667	5.03
RMT-17	841	4	3364	0	97.84	0.35572	0.3557	#NUM!
RMT-18	2705	9	9045	210.37	90.8	0.4591	0.4591	8.49
RMT-19	7128	4	1576	326.22	88.8	0.48847	0.4885	3.47
RMT-20	810	12	1692	539.63	85.49	0.53712	0.5371	3.14
RMT-21	2060	14	2282	475.61	88.79	0.48862	0.4886	4.74

If the  $kh_p$  value is plotted against PI from the calculation, it can be shown by the figure 1 as follows:

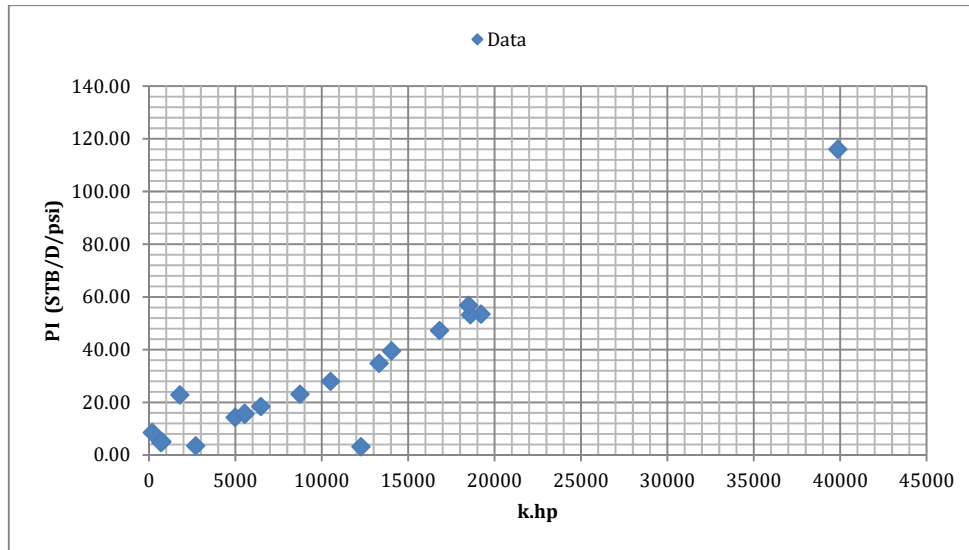

Figure 1. PI plot againsts  $K_{hp}$

Based on the  $kh_p$  and PI data in Table 1 and after the regression done, it resulting LINEST function outputs in Excel shown in table 2 as follows:

Table 2. LINEST Function to Estimate PI

	KH	bo	
<i>Coefficient</i>	$2.94 \times 10^{-3}$	-1.22	
<i>Standard Error (Seb)</i>	$4.37 \times 10^{-6}$	0.71	
<i>Coefficient of Determination (r<sup>2</sup>)</i>	0.9976	1.51	<i>Standard Error Y (Se<sub>y</sub>)</i>
<i>F-Value</i>	4507.63	11	<i>Degrees of Freedom denominator (Df<sub>a</sub>)</i>
<i>Regression Sum of Square (SS<sub>reg</sub>)</i>	10215.74	24.93	<i>Regression Sum of Residual (SS<sub>res</sub>)</i>
<i>t-value</i>	67.14	1.72	



From the function LINEST output in table 2, it is generated a linear function to estimate the PI is as follows:

$$PI = 2.94 \times 10^{-3} kh_p - 1.22$$

From the LINEST functions output above, do the t value and F value calculation to determine whether the function of the resulting statistics can be accepted. Calculation of PI' based on Linear Functions to Absolut Delta PI performed to determine the percentage of PI errors and differences of each well, so the results got in table 3 as follows.

Table 3. Result of PI and PI' Calculation

Well	PI (STB/D/ psi)	PI' (STB/D/ psi)	Delta PI (STB/D/ psi)	Abs Delta PI(STB/D /psi)	%error PI Vs PI' (%)	Abs %error (%)
RMT-01	14.29	13.21	1.08	1.08	7.54	7.54
RMT-02	34.81	37.69	-2.89	2.89	-8.29	8.29
RMT-03	15.43	14.85	0.58	0.58	3.76	3.76
RMT-04	23.07	24.23	-1.16	1.16	-5.02	5.02
RMT-05	47.26	47.97	-0.7	0.7	-1.49	1.49
RMT-06	53.46	55.04	-1.59	1.59	-2.97	2.97
RMT-07	18.37	17.59	0.78	0.78	4.25	4.25
RMT-08	53.17	53.22	-0.05	0.05	-0.09	0.09
RMT-09	15.82	14.83	0.99	0.99	6.25	6.25
RMT-10	116.02	115.7	0.33	0.33	0.28	0.28
RMT-11	97.5	86.18	11.32	11.32	11.61	11.61
RMT-12	39.49	39.81	-0.32	0.32	-0.8	0.8
RMT-13	56.8	52.92	3.88	3.88	6.84	6.84
RMT-14	27.93	29.45	-1.52	1.52	-5.45	5.45
RMT-15	8.49	9.45	-0.95	0.95	-11.23	11.23
RMT-16	5.03	5.46	-0.44	0.44	-8.67	8.67
RMT-17	6.02	8.44	-0.48	0.59	-10.12	10.12
RMT-18	8.49	9.45	-0.95	0.95	-11.23	11.23
RMT-19	3.47	3.18	0.29	0.29	8.41	8.41
RMT-20	3.14	3.52	-0.38	0.38	-12.12	12.12
RMT-21	4.74	5.26	-0.51	0.51	-10.77	10.77

The following Figure 2 is a plot between the PI againts  $kh_p$  based on data and a linear function to estimate the value of PI', and  $kh_p$  againts based on hypothetical data.

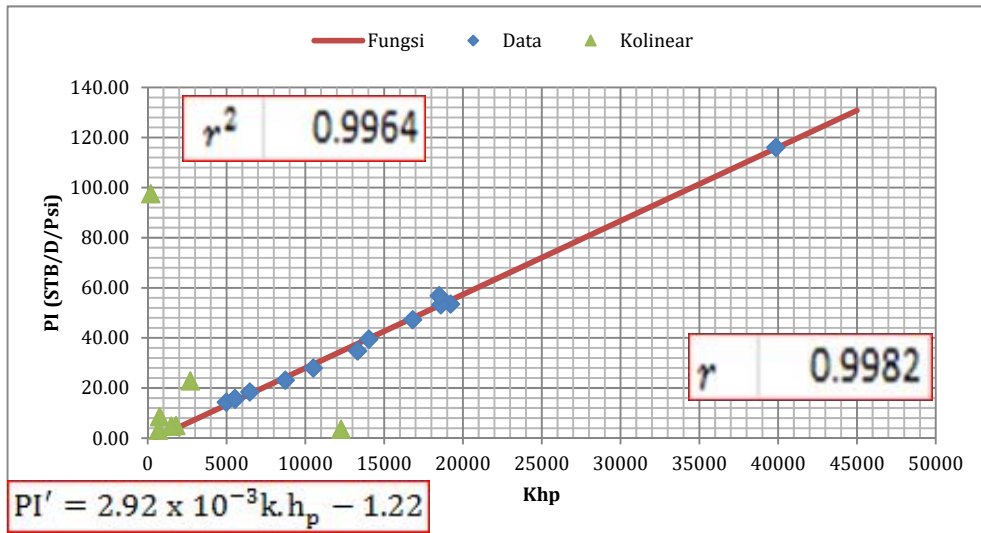

Figure 2. PI vs  $kh_p$

#### Calculation of WC Function (Watercut)

Meanwhile, water saturation ( $S_w$ ) was determined from log data interpretation that is determined based on the average price of saturation. The watercut data and water saturation ( $S_w$ ) are plotted on a scatter, then it will form the figure 3 as follows.

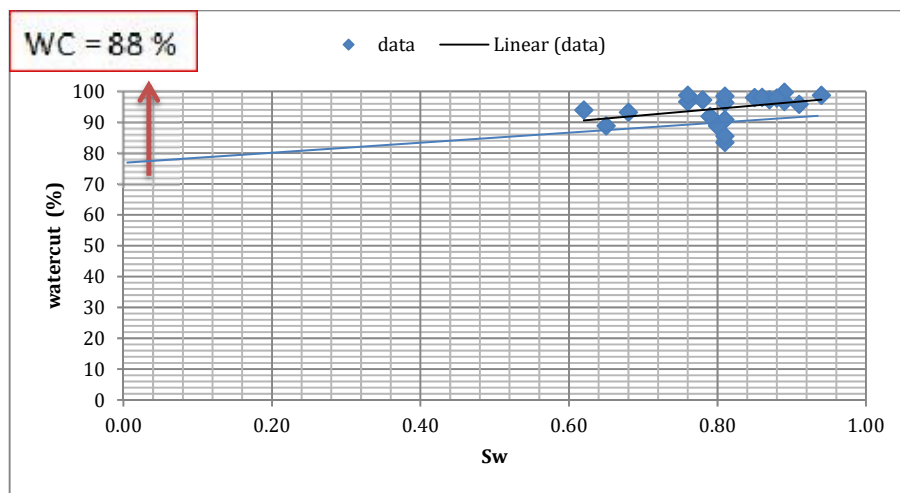

Figure 3. Plotted between  $S_w$  and WC at Trend Linear

From the field data can be conducted to determine the regression coefficients, to obtain the correlation polynomial to predict WC with LINEST function as shown in table 4.

Table 4. LINEST function to estimate WC using actual data

	Sw <sup>3</sup>	Sw <sup>2</sup>	Sw	Intercept	
<i>Coefficient</i>	332.02	-735.14	553.45	-48.28	
<i>Standard Error (S<sub>eb</sub>)</i>	122.52	215.99	106.11	10.59	
<i>Coefficient of Determination (r<sup>2</sup>)</i>	0.9598	4.38	#N/A	#N/A	<i>Standard Error Y (S<sub>ey</sub>)</i>
<i>F-Value</i>	151.04	19	#N/A	#N/A	<i>Degrees of Freedom Denominator (Df deno)</i>
<i>Regression Sum of Square (SS<sub>reg</sub>)</i>	8692.26	364.47	#N/A	#N/A	<i>Regression Sum of Residual (SS<sub>res</sub>)</i>
<i>t-value</i>	2.71	3.4	5.22	4.56	

From the LINEST function output in Table 4.8 generated the polynomial function to estimate WC is:

$$WC' = 553.45Sw - 735.14Sw^2 + 332.02Sw^3 - 48.28$$

From the LINEST function output above, calculate the t value and F value to determine whether the function of the resulting acceptable statistically. Figure 4 is a plot between Sw against watercut based data, the actual equation and the equation based on the data adjusted to the data hypothetical in making the regression line.

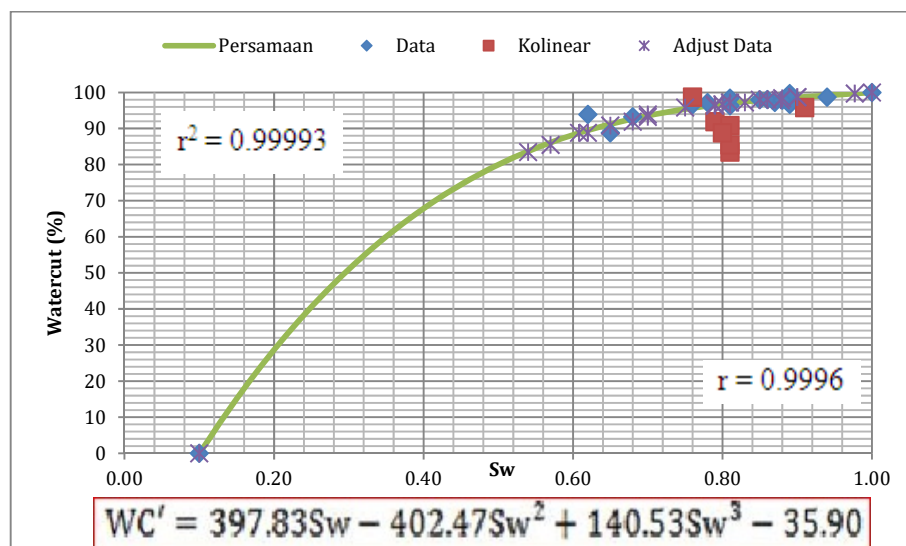

Figure 4. SwVs WC againsts the equation

#### Determination of Oil Flow Rate

Calculation was performed on each well to get the oil flow rate with a linear function of  $kh_p$  regression of the Productivity Index and polynomial functions for Sw regression against watercut generated at the output function LINEST, so it can be tabulated as shown in table 5.

Table 5. Q and Q' Calculation

Well	Pres	WC	WC'	PI (STB/D)	PI' (STB/D)	PG (psi)	PG' (psi)	max (STB/D)	max' (STB/D)	PIP+ 100ft (psi)	PIP+ 100ft' (psi)	Q (STB/D)	Q' (STB/D)
FP-01	410	97.2	96.97	14.29	13.21	0.4316	0.4315	5859.12	5417.62	293.16	293.15	1669.71	1544.09
FP-02	550	93.22	93.58	34.81	37.69	0.429	0.4292	19143.67	20730.83	292.9	292.92	8948.81	9689.85
FP-03	580	96.7	96.74	15.43	14.85	0.4313	0.4313	8949.39	8613.3	293.13	293.13	4426.44	4260.17
FP-04	570	96.3	96.5	23.07	24.23	0.431	0.4311	13152.74	13813.12	293.1	293.11	6389.44	6709.93
FP-05	490	98	97.78	47.26	47.97	0.4321	0.432	23158.14	23503.26	293.21	293.2	9300.48	9439.77
FP-06	490	97.23	97.4	53.46	55.04	0.4316	0.4317	26193.64	26970.59	293.16	293.17	10522.25	10833.76
FP-07	590	95.8	95.37	18.37	17.59	0.4307	0.4304	10839.91	10379.43	293.07	293.04	5455.44	5224.19
FP-08	580	98.4	98.29	53.17	53.22	0.4324	0.4323	30840.57	30869.35	293.24	293.23	15248.08	15262.69
FP-09	520	98.7	98.6	15.82	14.83	0.4326	0.4325	8225.95	7711.58	293.26	293.25	3586.86	3362.67
FP-10	485	98.03	97.96	116.02	115.7	0.4321	0.4321	56271.48	56112.14	293.21	293.21	22251.67	22189.2
FP-11	560	99.68	99.67	97.5	86.18	0.4332	0.4332	54600.29	48260.6	293.32	293.32	26001.24	22982.22
FP-12	440	93.92	93.58	39.49	39.81	0.4295	0.4292	17375.99	17515.62	292.95	292.92	5807.32	5854.88
FP-13	435	98.7	98.6	56.8	52.92	0.4326	0.4325	24708.42	23019.07	293.26	293.25	8051.07	7500.95
FP-14	410	96.6	96.5	27.93	29.45	0.4312	0.4311	11449.25	12073.13	293.12	293.11	3263.85	3441.9
FP-15	550	91.9	92.71	8.49	9.45	0.4281	0.4287	4671.1	5195.52	292.81	292.87	2184.26	2428.99
FP-16	550	83.47	83.7	5.03	5.46	0.4226	0.4228	2764.24	3003.9	292.26	292.28	1295.37	1407.59
RNT-17	480	97.84	98.26	#NUM!	8.44	0.432	0.4323	#NUM!	4049.05	293.2	293.23	#NUM!	1575.51
FP-18	550	90.8	91.24	8.49	9.45	0.4274	0.4277	4671.1	5195.52	292.74	292.77	2184.88	2429.9
FP-19	550	88.8	88.79	3.47	3.18	0.4261	0.4261	1910.35	1749.7	292.61	292.61	894.01	818.83
FP-20	445	85.49	86.13	3.14	3.52	0.4239	0.4244	1397.88	1567.35	292.39	292.44	479.38	537.35
FP-21	550	88.79	89.54	4.74	5.26	0.4261	0.4266	2609.74	2890.76	292.61	292.66	1221.31	1352.57

Plot between  $Q_o$  and  $Q_o'$  to each well, can be seen in figure 5.

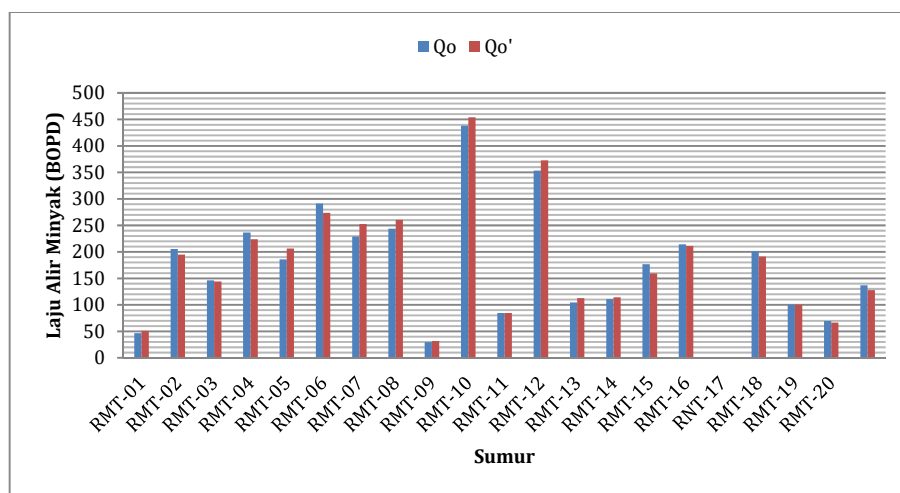

Figure 5. Plot  $Q_o$  and  $Q_o'$  in each well

Where:

$Q_o$  : Oil Flow Rate Data (BOPD)

$Q_o'$  : Oil Flow Rate Calculation Based Functions

Based on the calculations performed to estimate the oil flow rate based on function, then from the twenty-one (21) wells studied, it is known the total of oil flow rate is 3633.68 BOPD. While from the data is known that oil flow rate total of twenty-one well studied is 3605.55 BOPD. From these results, note the difference oil flow rate based on the data of the oil flow rate based function is 28.13 BOPD. The percentage error of both oil flow rate is 0.78%.

After assessing the watercut from water saturation data and Productivity index from permeability data, the thickness of the perforation of each well, then performed the calculations of oil flow rate using both equation for estimating the flow rate of oil in new productive zones.

#### 4. Conclusion

Based on the research are:

1. Estimated oil flow rate can be multiplied by the thickness of the perforation permeability parameters ( $k.h_p$ ) to determine the productivity index with  $r^2 = 0.9964$ . While water saturation parameters can be used to determine watercut of polynomial functions with  $r^2 = 0.9993$
2. The regression coefficient for  $k.h_p$  known by using LINEST function in Excel is  $2.92 \times 10^{-3}$ , intercept is 1.49 while the  $Sw$  regression coefficient is 397.83,  $Sw^2$  is (-5402.47),  $Sw^3$  is 140.53 intercept is (-35). The function equation for estimating Productivity index is  $PI = 2.94 \times 10^{-3} k.h_p - 1.22$  and polynomial equations to estimate water cut is  $WC = 397.83Sw - 402.47Sw^2 + 140.53Sw^3 - 35.90$
3. Oil flow rate estimation based on the function is 3633.68 BOPD while the oil flow rate data is 3605.55 BOPD, the difference is 28.13 BOPD with a percentage of 0.78% error. While the percentage of the average absolute error for each of the wells 5.47%

#### References

- Ariadji, Tutuka. Radjes, Muhammad Tities. 2012. Kuantifikasi Ketidakpastian Pengembangan Lapangan Secara Terintegrasi Surface dan Subsurface dengan Menggunakan Desain Eksperimental. Simposium Ahli Teknik Perminyakan Indonesia. Jakarta
- Gollan, Michael. Whitson, Curtis H. 1996. *Well Performance Second Edition*. Norwegian University Of Science and Technology. Tpir. Trondheim, Norway
- Heinemann, Zoltain E. *Fluid in Porous Media*. 2003. Montanuniversitat. Volume I. Leoben
- Houghton. Simal, Leopold. Hardle, Wolfgang. 2004. *Applied Multivariate Statistical Analysis*. Humboldt University & Catholic de Louvain. Berlin, Germany
- Jothikumat, et.al. *Statistics*. 2004. Government of Tamilnadu
- Kelkar, G. Mohan. *Aplied Geostatistic for Reservoir Characterization*. 2002. Tulsa, Oklahoma
- Koesoemadiata, R.P. 1980. *Geologi Minyak dan Gas Bumi*. Jilid I. Edisi Kedua. Institute Teknologi Bandung
- Mccord. *Reservoir Study and Future Performance Projections*. 1970. Petroleum Consultants. PT. CPI. Dallas. Texas
- Morrison, Faith.A. 2014 *Obtaining Uncertainty Measures on Slope and Intercept of Least Square Fit with Excel's Linest*. Michigan Technology University
- Pratama, Adi. Suharno. Zaenudin, Ahmad. *Analisa Petrofisika untuk Menentukan Potensi Hidrokarbon Pada Sumur ELP-23 Lapangan Prabumulih Menggunakan Metode Inversi*. Jurusan Teknik Geofisika universitas Lampung. Pertamina EP Region sumatra
- Noer, Ahmad. Sugito. 2010. *Statistika Lanjutan*. Edisi Pertama. BPFE-Yogyakarta



**The 7th Indonesia Japan  
Joint Scientific Symposium  
(IJSS 2016)  
Chiba, 20-24 November 2016**

---

- Schmuller, Joseph. 2013. *Statistical Analysis with Excel Third Edition*. Hoboken, New jersey
- Stanley, L.T. 1973. *Practical Statistic for Petroleum engineers*. Petroleum Publishing Company. Tulsa
- Stroud, K.A. 2001. *Matematika Teknik*. Edisi kelima, Jilid I. New York, Erlangga
- Tang, hong. 2007. *Using production Data To mitigate reservoir Connectivity uncertainty*. Louisiana State university. International Petroleum Technology. Dubai
- Supranto, J. 2008. *Statisik Teori dan Aplikasi*. Edisi Ketujuh. Erlangga

---

**Sediment Deposit of Floodplain Formation Resulting From  
Lateral Accretion Surfaces on Tropical Area: Case Study at  
Kampar River, Indonesia**

Yuniarti Yuskar<sup>a,\*</sup>, Tiggi Choanji<sup>a</sup>

<sup>a</sup>*Geological Engineering, Universitas Islam Riau, Jl. Kaharuddin Nasution No 113  
Pekanbaru, 28284, Indonesia*

---

**Abstract**

Kampar Rivers with the length of 413 km with average depth of 7.7 m and wide of 143 m. 60% of river is meandering fluvial system which transport and deposit a mixture of suspended and bed-load (mixed load) along low energy. River channel that moving sideways by erosion is undergoing lateral migration and the top of the point bar becomes the edge of the floodplain and the fining-upward succession of the point bar will be capped by overbank deposits of Kampar River. Along the Kampar Rivers, there are more than 60% of floodplain sediments and almost all of the floodplain formed by bend migration on the suspended-load channels of Kampar watershed. This formation consist of succession of fine to medium sand and silt/mud, with root traces, that form as drapes on the prograding bank. These beds dip mostly channel wards and quickly wedge out as they grade up and onto the floodplain. The depositional model is presented showing how lateral accretion can make a significant contribution to the preservation of fine-grained within channel deposits in contemporary floodplains. The examples presented here demonstrate that analogues to ancient point-bar deposits containing alternating sandstone and shale sequences are common in the low-energy fluvial environments of Riau rivers especially Kampar rivers.

**Keywords**

*Kampar Rivers, lateral accretion, floodplain, meandering, depositional model.*

---

**1. Introduction**

Meanders develop by erosion of the bank closest to the thalweg, accompanied by deposition on the opposite side of the channel where the flow is sluggish and the bed-load can no longer be carried and river is considered to be meandering if there is accumulation of sediment inside of bends. Meandering rivers transport and deposit a mixture of suspended and bed-load (mixed load) a long low energy. The bed-load is carried by flow in the channel, with the coarsest material carried in the deepest parts of the channel. Finer bed-load is also carried in shallower parts of the flow and it is deposited along the inner bend of a meander loop where friction reduce the flow velocity (Nichols, 2009). Type of sediment is formed by meandering pattern are channel deposit, point bar, natural levee, floodplain, oxbow lake, and crevasse splay.

The relative contribution of a variety of accretion deposits to the formation of meandering river floodplains have been the subject of prolonged discussion in the

---

\* Corresponding Author, Yuniarti Yuskar. Tel.: +62-822-6790-2974.  
E-mail address: yuniarti\_yuskar@eng.uir.ac.id

geomorphological literature (Page, et al, 2003). A channel moving sideways by erosion on the outer bank and deposition on the inner bank is undergoing lateral migration and the deposit on the inner bank is point bars and it will show fining-up from coarser material at the base to finer at the top (Nichols, 2009). Migration of meanders produces a general fining-upward point bar deposits and, in turn silty and muddy floodplain deposits (Allen, 1970; Boggs, Jr 2006). Multiple episodes of meander migration produce vertical stacking of fining-upward succession in meandering-river deposit (Boggs Jr, 2006).

Floodplains are dynamic feature that co-evolve with channel so at present no universal theory is available to predict floodplain width in natural rivers (as a function of drainage area, bank-full discharge, or sediment flux, etc) because floodplain morphology dynamically integrates across these and the other factors, over some unconfined time interval in the environment history of the watershed (Patrick Belmont, 2011). In this study we focus on floodplain deposit resulting from lateral accretion surface at river bend of Kampar Kanan River, Riau Province. Lateral accretion surfaces are most distinct when there has been an episode of low discharge allowing a layer of finer sediment to be deposited on the point bar surface (Allen 1965; Bridge 2003; Collinson et al, 2006; Nichols, 2009).

## **2. Overview of Kampar River**

One of the meandering river system in the Riau Province, Indonesia is the Kampar River. Kampar River on the island of Sumatera in Indonesia originates in the mountainous Bukit Barisan of West Sumatra, and empties into the Malacca Strait on the island's eastern coast. The river is the confluence of two big tributaries are Kampar Kanan River and Kampar Kiri River. The tributaries meet in the Langgam subdistrict, Pelalawan Regency, before flowing into the Malacca Strait as the Kampar River. Koto Panjang, an artificial lake upstream of the river, is used to power a hydroelectric generating plant.

In this case, data collected from location in one of the Kampar Kanan river bends at Buluh Cina Village, Kampar District, Riau Province, Indonesia as shows in Figure 1. The River has a length of 413 km and an average depth of 7.7 m and average wide of 143 m. Fluvial meander system develop typical morphology that oxbow lake with tropical rain forest, sand bar and river with fishery product. It has been used as a local attraction. This study is one of the appreciation of Buluh Cina Village community that has been keeping the forest and natural conditions so this area can be used as one of the Geo-tourism in the Riau Province.

### **2.1. Geomorphic and Geological Setting**

Buluh Cina Village is plain area with an elevation of 2 to 6 meter above sea level. The landscape of case study area is characterized mainly by active channels, abandoned channels, natural levee, backswamps and floodplain. The study area is the floodplain of Kampar Kanan River, so this area will flood if higher rainfall. Distribution of geomorphic feature throughout the study area suggests that the landforms were developed mostly during Quaternary. Along The Kampar Kanan River is deposited Young Alluvium (Qh) during Holocene-aged. Young Alluvium (Qh) are consist of gravels, sands and clays.



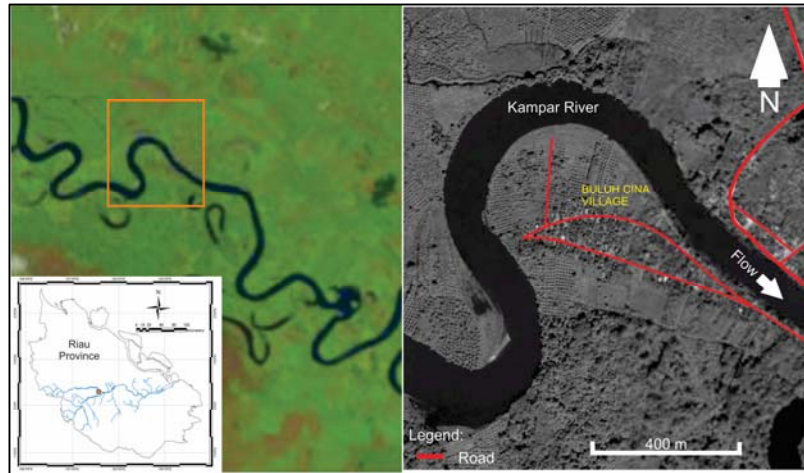

Figure 1. Location of Study Area.

The stratigraphy formation in the Buluh Cina Village are Older Alluvium (Qp) aged Pleistocene to Holocene. This sediments are consist of gravels, sands, clays, vegetation rafts and peat swamps (M.C.G. Clarke, W.Kartawa, A.Djunuddin, E. Suganda dan M.Bagdja, 1982).

Most of sand deposit along Kampar Kanan River has become mining site location, whether they have permission or illegally. This activity not only will affects the deposition process that happen naturally in the river, but also affects the river biota, tourism and water resources become damaged due to the mining. Morphological changes is forming in the Kampar Kanan River happen because of natural levee (riverbank) erosion and sand mining, it make sliding riverbank and deepening of the riverbed.

## 2.2. Floods

Buluh Cina area located as floodplain area from Kampar Kanan River. This water are provided from large catchment area up to 5.321 km<sup>2</sup> came from Gadang Mountain and surroundings, with debit of water about 700 to 1000 m<sup>3</sup>/s and relative slope 0,0008. In headwater part, there are hydroelectric power plant at Koto Panjang that built beside for electricity, and also to control volume of water. If there's any increasing volume due to heavy rain on the top side area and the dam of power plant cannot endure it, the condition will become a big flood that will be affected to this area. And this event has happened in January 2016, which the water of the river rising about 3 m from the condition at dry season, and flooding all the area.

## 3. Methodology

Data collection on this research consist of three location of trench (TR-01, TR02, and TR-03), two drilling data (BC-01 and BC-02), and satellite image from landsat. The methodology for this study are consist of several steps and measurement, starting from scouting field surveys to check condition and to mark the drilling position, and then continued doing trenching at three position which located 2 m and 400 m away from the river. Some of them are already excavated and exposed, and revealed a 1 to 2 meter thick sequence of sediment.

Drilling also conducted at two location up to 5 meter depth using hand auger for coring, located 5 meter from river and 400 meter away from the river. This drilling data

will provide a better visualization of the texture of sediment from bottom to top of the layer. All of sediment that taken from trenching and drilling, will be analyze with sieve analysis by using mesh from 2.38 mm, 1.19 mm, 0.6 mm, 0.297 mm, 0.149 mm, and 0.074 mm to measure the weight each grain size and define the dominate grain size in every layer collected from field.

Interpretation of satellite image are using landsat image from april 1989 until april 2016. This image provide visual image to seek the geometrical changes of the river, and interpret the migration of the channel, and also correlate it with field survey data.

#### 4. Lateral Accretion and Floodplain Deposit

##### 1.1. Lateral Accretion Deposit on Kampar Kanan River at Buluh Cina Village

Based on the comparison of Satellite image data in 1989 and 2016, it shows a migration of the channel that occurred in Kampar Kanan River that located near the Buluh Cina village as shows in Figure 2. The basic dynamics of flow around meanders leads to erosion on the outside parts of bends and deposition on the point bars. Helical flow transport sediment, eroded from the cut bank, across the stream along the bottom and deposits it by lateral accretion on the point bar (Boggs, S.Jr. 2006. p.252). As the channel migrate the top of the point bar become the edge of the floodplain and the fining-upward succession of the point bar will be capped by overbank deposits.

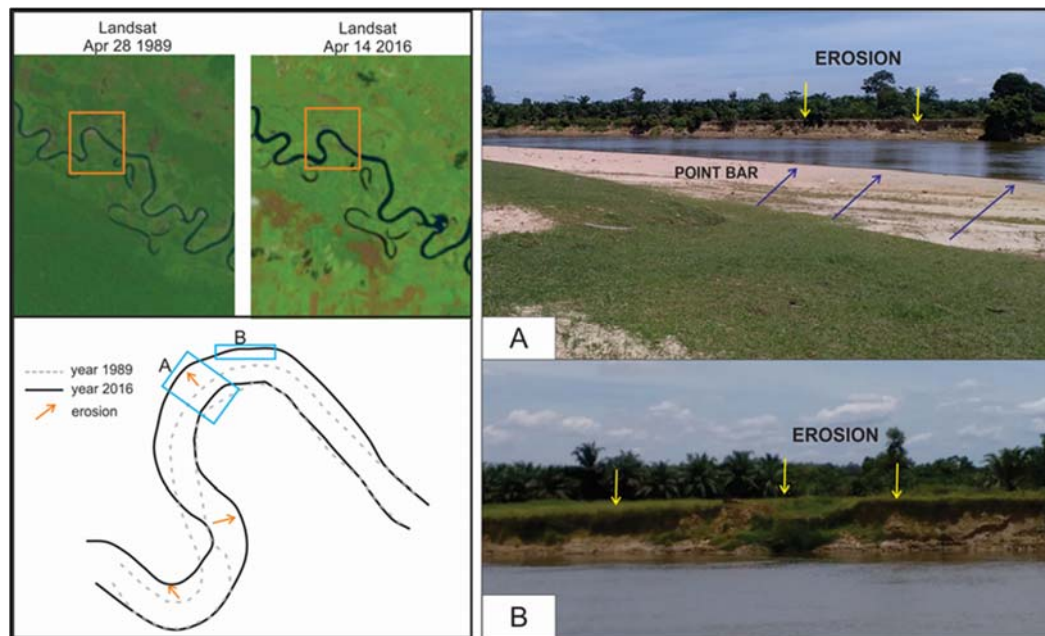

Figure 2. (A) Satellite image that showing geometrical changes the position of the river and image of point bar as result from river migration, and (B). Erosion at the nothern side of the river.

Field observations indicate that lateral accretion consists of a point bar, oblique accretion and overbank deposit. Sediment of point bar deposited medium sand with good sorting and upwards-fining couplets during flood events. Some flood channels become enlarged during floods, and may become the dominant channel (Wood, S.H et al, 2008). Oblique accretion sediment is defined here as the lateral accumulation of fine-grained floodplain deposit by progradation of a relatively steep convex bank in association with channel migration (Page and Nanson, 1982). Oblique accretion are developed on the meandering low energy rivers of Kampar Kanan River. The presence of

oblique-accretion deposits in Buluh Cina Floodplain was demonstrated by preliminary investigations at natural bank exposure, coring to a depth 5 meter, and trenches excavated at Kampar Kanan Rivers.

When the point bars occur, oblique accretion deposit occupy that part of the convex bank directly above at the point bar (Page, K.J 2003). At site oblique-accretion layers consist of sand, muddy fine sand strata dipping conformably with bank surface as shows in Figure 3. Dip angles vary from near horizontal at the top and the bottom to less than 15° while at the bottom; there are point bar deposits with dip angle more than 15°.

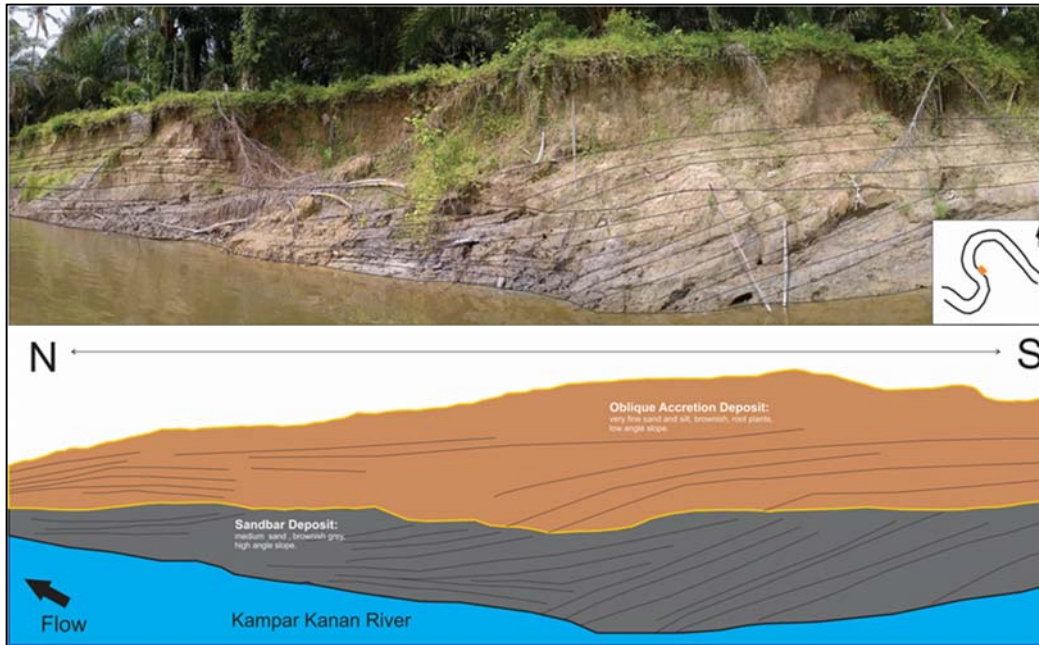

Figure 3. Deposit at western side of the river meander which shows sand bar deposit at bottom position with relative steep slope and deposit of oblique accretion at top with gentle slope than sand bar deposit.

On trench location (TR-01 and TR-03) shows very fine to fine sand sediments, root plant on the top and bioturbation on the top layer. It indicates as oblique accretion deposit. The decreasing rootplant and bioturbation and sediment with medium sand on the bottom layer and it indicates as point bar deposit as show in Figure 4.

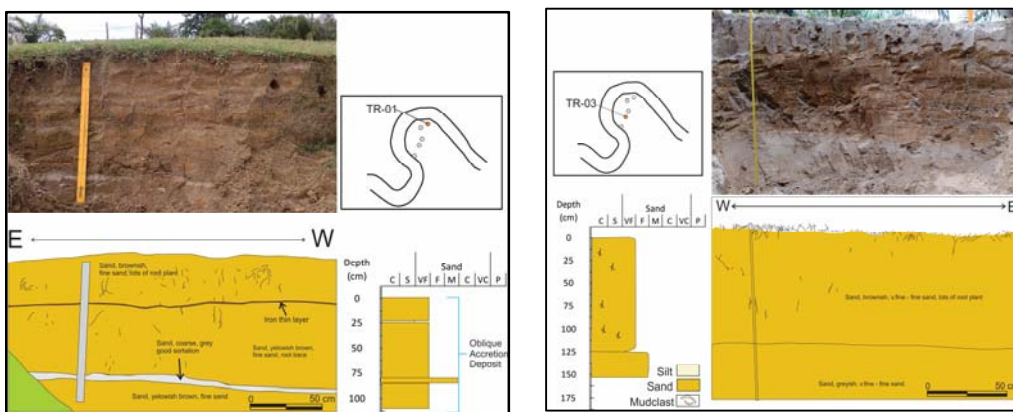

Figure 4. Deposit of lateral accretion which characterize with fine sand sediment at two different location ( TR-01 and TR-03).

On TR-02 (Trench) location consist of very fine sediment at the bottom of the layer (125 to 75 cm) which indicates an oblique accretion deposit, and then silt – mud with 75 m thick that interpret as overbank deposit as shows in figure 5. The boundary between silt and fine sand are gradual contact which affected from different grainsized and hardness, and also activity of organism and pedogenesis. Overbank sediment deposited on a floodplain was identified in the field using standard criteria (Allen, 1965; Brown, 1987; Guccione, M. J, 1993). It was distinguished from channel deposits and colluvium by general lack of gravel, the lateral fining of texture with increasing distance from the channel and general lack of bedding , except proximal to channel (Guccione, M.J 1993).

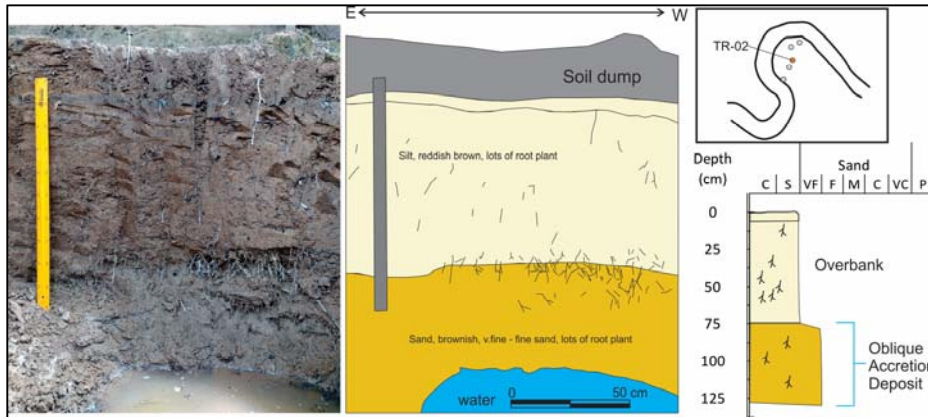

Figure 5. Succession at Trench (TR-02) that shows oblique accretion on bottom of the layer and overbank deposit at the top.

Based on sieve analysis from TR-01, TR02, and TR-03, considered from two different deposit shows that medium sand dominate at the bottom and very fine to fine sand sediment dominate at the upper part as shows in figure 6.

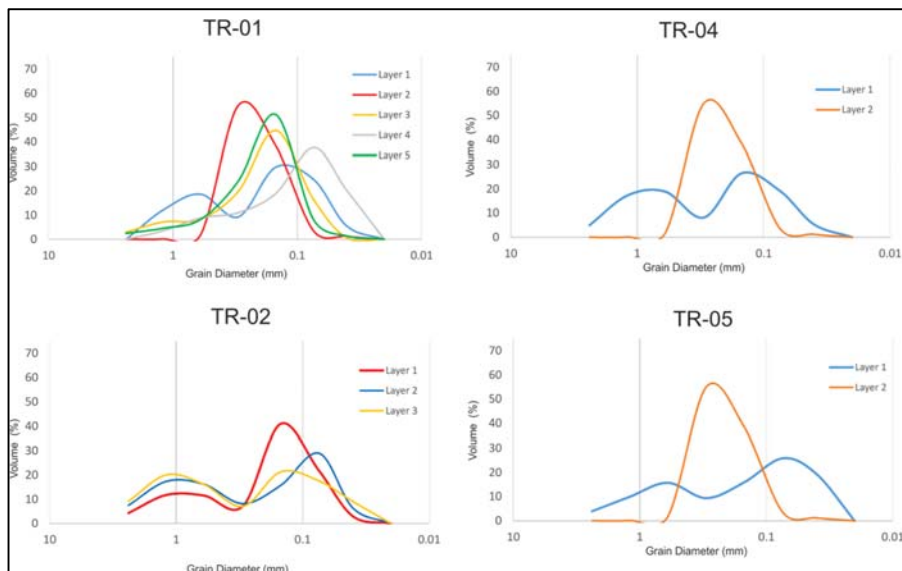

Figure 6. Sieve analysis that shows percentage of grain size distribution of each layer at four location (TR-01, TR-02, TR-04, and TR-05).

## 1.2. Lateral Accretion Deposit on Kampar Kanan River at Buluh Cina Village

Floodplain is a strip of land that borders a stream channel and that is normally inundated during seasonal floods. Sediment is transported over the flooding as bed load and suspended load during floods. The sediment comes from the main channel, the valley sides and the floodplain itself (Bridge, S. John in Posamentier, W. H. And Walker, G. R, 2006 p: 119). Based on drilling data using 5 meter depth of core hand auger, it shows that floodplain formation originated from lateral accretion as sandbar, oblique accretion and overbank. Sandbar deposit located at the bottom and continued with oblique accretion deposit, and covered with overbank deposit at the top. The overbank deposits are not always shown in the floodplain formation, due to erosion process. Stratigraphy of this floodplain formation are showing repetitive deposit of sandbar and oblique accretion that there are two event happened in this area as shows in figure 7.

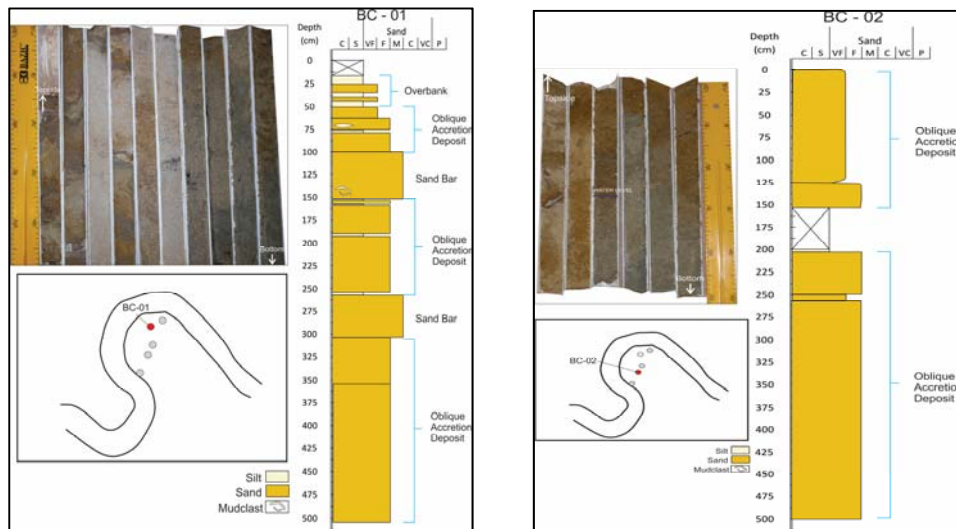

Figure 7. Analysis stratigraphy define from core data (BC-01 and BC-02) .

## 5. Discussion

Based on this research, it considered that lateral accretion gives a big contribution to the formation of floodplain. This formation form two type of deposit which are sandbar and oblique accretion that form at low energy in meandering river. Floods that happen periodically in this area also bring finer sediment such as silt and mud that characterize overbank deposit but not significantly shown in this area. Therefore, in floodplain formation, lateral accretion gives bigger contribution than vertical accretion. Lateral accretion deposit characterize with fine to medium sand while overbank characterize with finer sediment (silt and clay).

The floodplain model that modified by (Page et al, 2003) state that there are three models of stratigraphy produced by oblique accretion for different floodplain settings: floodplain with point bar, floodplain with no point bar and floodplain with point bar and scrolls. Based on the model, this area are include in model of floodplain with point bar as shows in Figure 8.

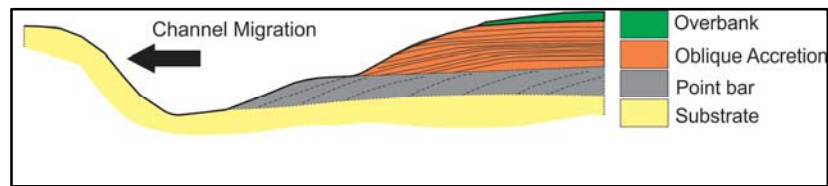

Figure 8. Model of stratigraphy in study area that related with Floodplain model with point bar (modified from Page, et al 2003)

## 6. Conclusion

Floodplain formation in study area are related with model floodplain with point bar which consist of succession of fine sand to medium sand with steep dip beds as sandbar and fine sand with gentle dip bed as oblique accretion deposit, and silt/mud, with root traces as an overbank deposit, all of this deposit form as drapes on the prograding bank. These beds dip mostly channel wards and quickly wedge out as they grade up and onto the floodplain. In this study, showing that lateral accretions are making significant contribution rather than vertical accretion to the preservation of fine-grained within channel deposits in contemporary floodplains.

## Acknowledgements

We would like to say thanks to Universitas Islam Riau for all the support and the students on The Department of Geological Engineering, Faculty of Engineering, Universitas Islam Riau for helping us on this research.

## References

- Allen, J.R.L (1965). A review of the Origin and Characteristic Of Recent Alluvial Sediments. *Sedimentology* 5, 89 – 191.
- Allen, P.A & Allen, J.R (2005) *Basin Analysis: Principle and Applications* (2nd edition). Blackwell Science, Oxford.
- Belmont, P. (2011). Floodplain Width Adjustments in Response to Rapid Base Level Fall and Knickpoint Migration, *Geomorphology* 128 p. 92-102
- Boggs, S. Jr. (2006). *Principle of Sedimentology and Stratigraphy* 4th ed, Pearson Prentice Hall, New Jersey, United States of America.
- Bridge, J. S (2003) *River and Floodplains: Forms, Processes, and Sedimentary Record*. Blackwell Science, Oxford.
- Brown, A.G. (1987). Holocene Floodplain Sedimentation and Channel Response Of The Lower River Severn, United Kingdom. *Z. Geomorph. NF* 31, 293-310.
- Clarke, M.C.G et al (1982). *Geological Map of The Pakanbaru Quadrangle, Sumatra*. PPPG.
- Collinson, J.D., Mountney, N & Thompson, D. (2006). *Sedimentary Structure*. Terra Publishing, London.
- Guccione, M.J. (1993). Grain-Size Distribution of Overbank Sediment and its Use to Locate Channel Position. *Spes. Publs Int. Ass. Sediment* 17 p. 185 – 194.
- Nichols, G. (2009). *Sedimentology and Stratigraphy* 2nd Ed, John Wiley & Sons Ltd, West Sussex, United Kingdom.
- Nichols, G.j. & Fisher, J.A (2007). Processes, Facies and Architecture of Fluvial Distributary System Deposit. *Sedimentary Geology*, 195. 75-90.
- Page, K.J et al. (2003). Floodplain Formation and Sedimen Stratigraphy Resulting From Oblique Accretion on The Murrumbidgee River, Australia. *Journal Of Sedimentary Research* Vol. 73 No.1. Tulsa, Oklahoma, USA.

- Page, K.J., and Nanson, G.C. (1982) Concave-bank benches and association and Floodplain Formation: *Earth Surface Processes and Landforms*, v.7, p.529-543.
- Posamentier, H. W and Walker, R.G (2006). *Facies Models Revisited*, p. 119. Tulsa, Oklahoma. USA
- Wood, Spencer H., Ziegler, Alan D., Bundarasin, T. (2008). Floodplain Deposit, Channel Changes and Riverbank Stratigraphy of Mekong River Area at 14th Century City of Chiang Saen, Northern Thailand, *Geomorphology* 101 p. 510 – 523.

---

## Radiation Performance of X-Band Array Antenna Implemented Using Unequal Power Divider Feeding System

E. T. Rahardjo, M.Erfinza, and F.Y. Zulkifli  
*Antenna propagation and Microwave Research Group (AMRG)  
Department of Electrical Engineering, Universitas Indonesia  
Kampus Baru UI Depok*

---

### Abstract-

This paper presents radiation performance of an x-band array antenna using unequal power divider. A 6x32 element array antenna is designed and fed by corporate feeding network. The feeding network is realized using unequal power divider implemented in stripline transmission line. Simulation results showed that the design of array antenna and its feeding network has an excellent radiation performance.

Keywords – X-band array antenna; Unequal power divider; stripline transmission line; microstrip antenna;

---

### I. INTRODUCTION

The X-band spectrum frequency that span from 8 - 12 GHz is utilized for various applications such as satellite communication, radiolocation, meteorological, maritime radio navigation, radio astronomy and space research. In such radio system, antenna plays an important role to achieve high performance of the system. Recently, numerous antennas in X-band frequency have designed and implemented for purpose of radar application.

Microstrip antenna has been used for many radar applications in X-band frequency because it has many benefits such as compact and low profile [1]-[2]. However, the sidelobe level of the developed antenna is still higher, at the level of >-15 dB.

To suppress the value of sidelobe level, array technique is required from the microstrip with current distribution technique in each sub-array. The unequal power divider that has been designed in [3] is using Chebyshev polynomial technique and has suppressed the value of sidelobe level into 26.4 dB. However, the use of series-feed configuration causes the element to affect each other so that the current distribution is uneven and the array configuration become limited. The using of Chebyshev current distribution for more array is designed in [4] with 32 element configuration which every element is fed with different current value. The implementation adversely and the cost of antenna system is increase because it requires additional power divider and attenuator.

In this paper, an array antenna and its feeding are designed to operate in 9.4 GHz frequency. The array of microstrip antenna is fed using an unequal power divider. A triangular current distribution technique is used to achieve low side lobe level as required by the system.

### II. 1x6 ARRAY ANTENNA and FEED DESIGN

The propose array antenna has a dimension of 6x32 elements. The antenna element is chosen to use a usual rectangular microstrip antenna namely as a conventional antenna. The dimension of the array is designed to fulfill the X-band array antenna with frequency of 9.4 GHz, 100 MHz bandwidth, azimuth beamwidth of 50 and elevation beamwidth of 180 and less than 30 dB sidelobe level for optimal functionality.



The antenna was designed using Taconic-TLY-5 dielectric substrate with dielectric permittivity 2.2 and thickness 0.8 mm. As the first step, a conventional rectangular microstrip antenna is designed and simulated as an element for antenna array. Then, a subarray of 1x6 element is designed using previous antenna element. To obtain the required sidelobe level, the current distribution for each element is calculated by chebyshev polynomial. Unequal power divider is used to obtained current distribution for each element in the subarray [4]. The 1x6 element subarray is shown in Figure 1.

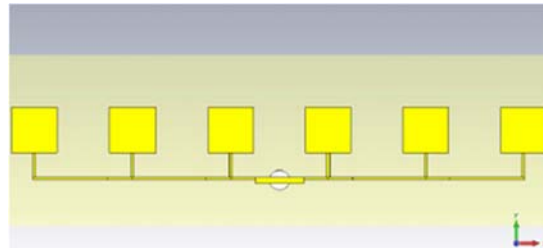

Figure 1. 1x6 element sub array antenna.

The power divider was designed in stripline transmission line using Taconic-TLY-5 dielectric substrate with dielectric permittivity 2.2 and thickness 1.6 mm. The corporate feed configuration with tapered technique is used to ensure the current distribution is following the triangular equation [5]. The width of tapered lines, namely  $Z_t(i)$  and  $Z_f(i)$ , have a specific value obtained from impedance which calculated from equation (1) and (2).

$$Z_t(i) = Z_0 \times 1 + \text{PAPB}^{0,5} \times \text{PAPB}^{0,25} \quad (1)$$

$$Z_f(i) = Z_0 \times \text{PAPB}^{-0,25} \quad (2)$$

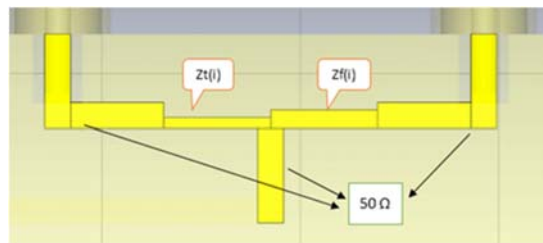

Figure 2. Corporate Feed Unequal Power Divider.

The full designed of unequal power divider is shown in figure 3. The configuration for 16 port in each left and right side is an amplitude reflection of each other that was designed to provide current distribution that following the triangular current distribution

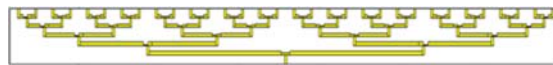

Figure 3. Full Design of 1x32 Corporate Feed Unequal Power Divider.

The simulation is carried out using CST microwave studio. The return loss characteristic, as indicated in Figure 4, show that the power divider works in 9.4 GHz frequency. The value of insertion loss and amplitude from 32 output port of the power divider was compared with triangular distribution in theory as shown in figure 5.

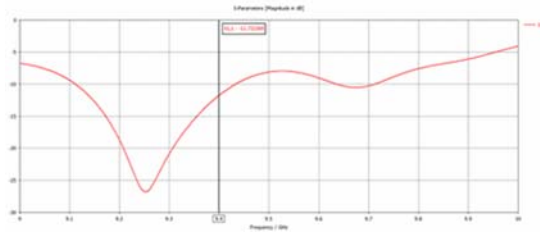

Figure 4. Return loss of 1x32 power divider.

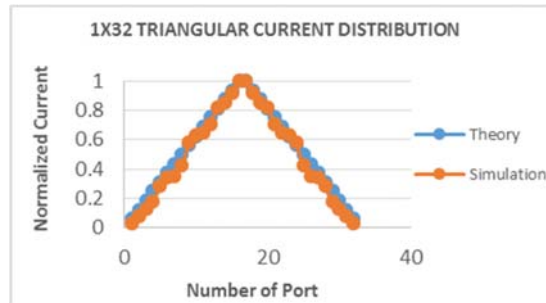

Figure 5. Comparison of triangular current distribution.

### III. ARRAY ANTENNA INTEGRATION DESIGN AND SIMULATION

To achieve higher gain and smaller azimuth beamwidth, the 1x6 subarray is then arrayed for 6x32 elements. The six vertically elements of arrayed antenna which have been designed previously were used to achieve small elevation beamwidth and sidelobe level. Power divider then is used to feed array for the 32 elements horizontally. The design of array antenna system is shown in figure 5. Semi-rigid cables is used to connect between array antenna and the power divider in a perpendicular configuration.

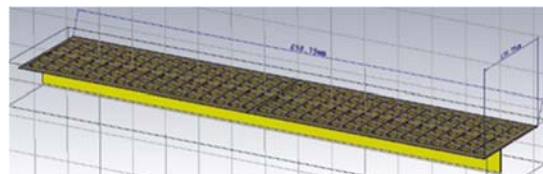

Figure 6. Design of 6x32 array antenna with power divider.

The simulation of 6x32 array antenna is carried out. The result show that antenna works well in frequency of 9.4 GHz, with return loss of -20.01 dB and bandwidth over 100 MHz as shown in figure 7. These results agree with the trend and, thus, the bandwidth is able to cover the desired frequency band from 9.33 to 9.45 GHz.

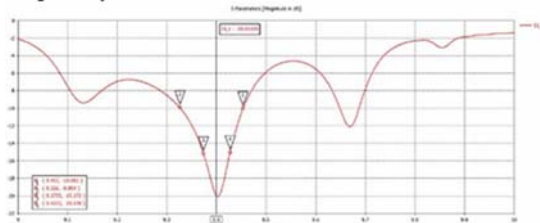

Figure 7. Return loss of 6x32 array antenna.

Figure 8 shows the measured and simulated produce by the propose antenna at 9.4 GHz. On the horizontal plane, in Figure 8(a), the measured antenna gain, azimuth half-power beamwidth and sidelobe level were 26.4 dB, 3.5o and -29.2 dB, respectively. The elevation

half-power beamwidth and sidelobe level on the vertical plane in figure 8(b) were 17.8o and -26.8 dB, respectively.

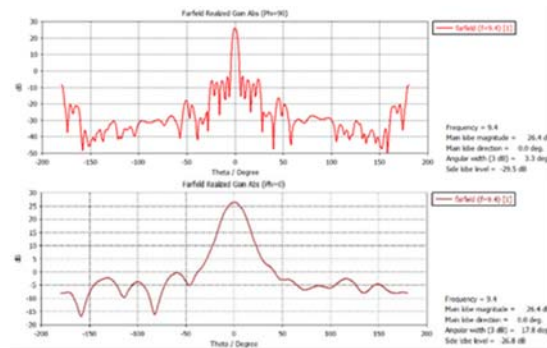

Figure 8. Measured and simulated Radiation Pattern at 9.4 GHz on (a) a horizontal plane and (b) a vertical plane.

#### IV. CONCLUSION

The design of 1x32 unequal power divider as a feeding system of 6x32 array antenna that works in X-band frequency has been described and simulated with excellent radiation characteristic.

#### ACKNOWLEDGEMENT

This research was supported by The Ministry of Research, Technology and Higher Education, The Republic of Indonesia under the National Research Advancement (PUSNAS) with contract no. 0436/UN2.R12/HKP.05.00/2015.

#### REFERENCES

- Hajian. M, Zijderfeld. J, Lestari. A. A, and Ligthart. L. P, "Analysis, Design and Measurement of Series-fed Microstrip Array Antenna for X-Band INDRA: The Indonesian Maritime Radar.
- F.Y. Zulkifli, Y. Wahyu, Basari, and E. T. Rahardjo. "Microstrip Antenna Array for Coastal Surveillance Radar". Jurnal Elektronika dan Telekomunikasi Vol. 13, No. 2, Desember 2013
- F.-Y. Kuo, R.-B. Hwang, "High-Isolation X-Band Marine Radar Antenna Design, "IEEE Transactions on Antennas and Propagation, vol. 62, no. 5, May. 2014.
- E.T. Rahardjo, D. P. Yusuf, and F. Y. Zulkifli, "Microstrip Array Antenna for X-Band Application", Asia-Pacific Microwave Conference Proceedings (APMC), Nanjing, China, December 2015.
- Fitri Yuli Zulkifli, Taufal Hidayat, and Eko Tjipto Rahardjo, "Sidelobe Level Suppression Using Unequal Four-Way Power Divider for Proximity Coupled Microstrip Antenna", Asia-Pacific Microwave Conference Proceedings (APMC), page 1166-1168, November 2013.

---

**Geophysical Modelling Using Gravity Data Of Meteorite Impact  
Crater At Bukit Bunuh, Lenggong, Perak, Malaysia**

**Dewandra Bagus Eka Putra<sup>a</sup>, Abdul Rahim Samsudin<sup>b</sup>, Tiggi Choanji<sup>a</sup>**

*<sup>a</sup>Universitas Islam Riau, Jl. Kaharudin Nasution No. 113, Pekanbaru 28284, Indonesia*

*<sup>b</sup>Universiti Kebangsaan Malaysia, Bangi Selangor 43600, Malaysia*

---

**Abstract**

A geophysical survey using gravity method was conducted at Bukit Bunuh, Lenggong, Perak, Malaysia, to determine the occurrence of a subsurface impact crater, based on the discovery of meteorite impact rock, suevite, in the study area. A standard correction was applied to all the gravity data to produce Bouguer gravity anomaly of the study area. The Bouguer gravity anomaly was used to produce several maps of gravity anomalies by filtering processes and relate them to the geological structure and tectonic history of the study area. Data processing and interpretation were conducted using geophysical software, Oasis Montaj. This software was used in a number of gravity data filtering processes, such as Low Pass Filter (LPF) and the Total Horizontal Derivative (THD). Bouguer gravity anomaly map shows a circular structure in Bukit Bunuh area which is interpreted as a remnant of meteorite impact crater. The gravity anomaly appears to decrease from the edge of the crater and increases at the center. This feature indicates a complex crater structure which has central uplift. The Total Horizontal Derivative map of residual gravity anomaly shows structural trend such as lineaments and faults that dominant to the northwest-southeast direction. A model was produced using GM-SYS 3D software to determine the geometry of the impact crater. The interpreted 3-D model shows a diameter of the impact crater was approximately 2368 m and depth of about 400 m. The model of the crater appears to tilt toward southeast, which illustrates the ancient meteorite that hit this area about 1.83 million years ago possibility came from northwest direction.

**Keywords**

*Keywords:* Geophysics; Gravity; Bukit Bunuh; Impact Crater; Model

---

**1. Introduction**

Gravity survey is a measurement of the gravitational potential field in a series of different locations for a particular purpose. The objective of this survey is to relate the density differences to anomaly gravity changes (Parasnis, 1986). The anomaly gravity changes shows horizontal density differences of subsurface rocks or materials and could be used to determine the subsurface structure (Samsudin, 1990).

A gravity survey was conducted in Bukit Bunuh, Perak, Malaysia. The study was initiated by a discovery of meteorite impact rock, called, suevite (Fig. 1), around Bukit

Bunuh area. The presence of suevite provides an evidence of possible ancient meteorite impact that had taken place in the study area.



Figure 1: Meteorite impact rock, suevite discovered in Bukit Bunuh area

Bukit Bunuh area (Fig. 2) was initially a rubber plantation until it had been replanted with palm oil plantation in 2001. During the replanting period, some suevite boulders and artifacts of archaeological significant were exposed, which was then confirmed by a palaeo-environmental mapping of Lenggong Valley. Since then the area has been set as a centre for archaeological and meteorite impact research lead by Universiti Sains Malaysia. Bukit Bunuh area is believed to be impacted by a meteorite around 1.83 million years ago, which developed an impact crater. However due to tropical weather and erosion, the geomorphology condition of the crater has been destroyed and the crater structure buried by a relatively new sediments.

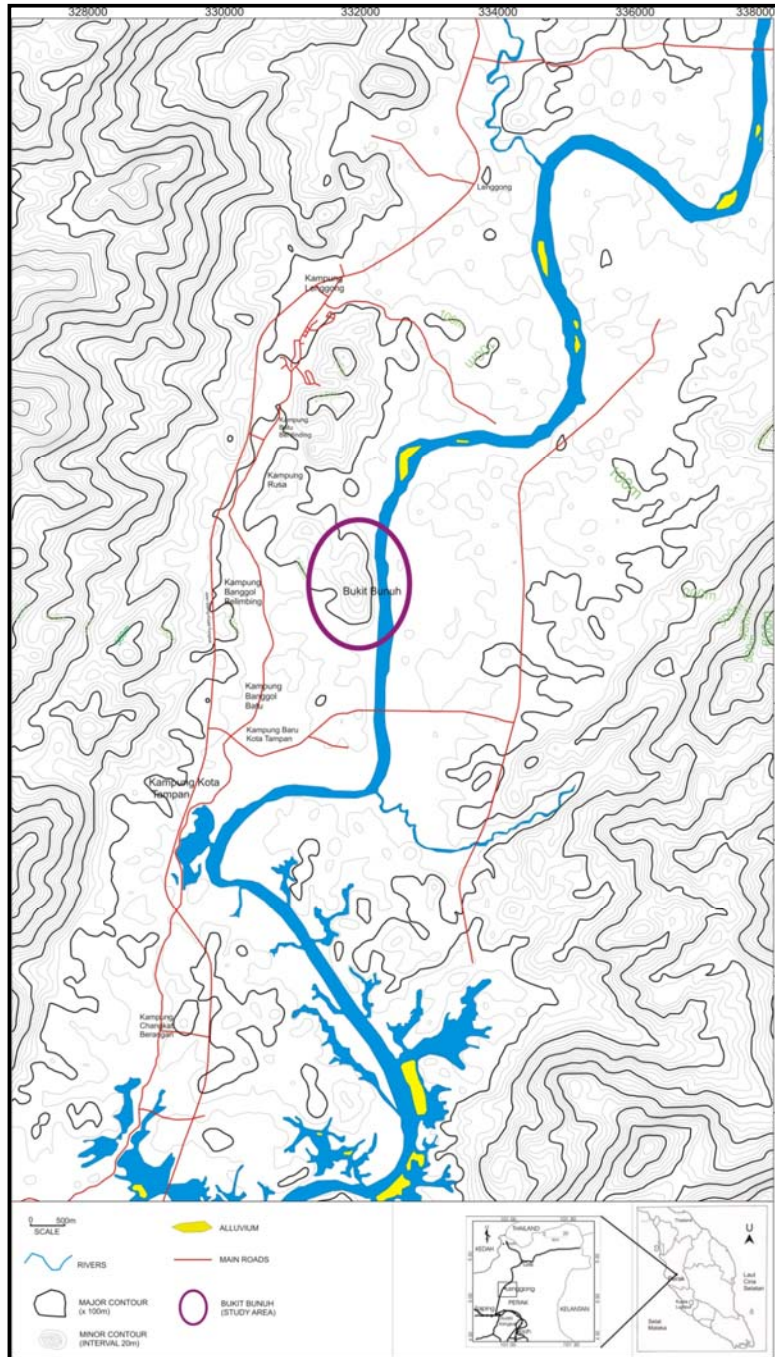

Figure 2: Location map of Bukit Bunuh area

Based on Lenggong topographic map, sheet number 3464, series L7030, scale 1:50 000, issued by Department of Survey and Mapping Malaysia, 1986, Bukit Bunuh is

situated at longitude 100°58.5' East and latitude 5°4.5' North. The study area is a hilly region that could be seen in the topographic map (Fig. 3), indicated by closed contour lines on the eastern and the western part. On the southern part, Bukit Bunuh is border with Raban Lake and Perak River flows on the eastern area.

Geophysical gravity survey can contribute a supporting evidence for meteorite impact structure in Bukit Bunuh. The fulfillment of all criteria would help the study area to be recognized as a World Heritage Site by UNESCO.



**Figure 3: Topographic map of study area**

Based on Geological Map of Lenggong valley issued by Mineral and Geoscience Department Malaysia in 2007, scale 1:200 000 (Fig. 4), the study area consists of

Quaternary sediment and small lithology unit of Tertiary tephra ash and metasediments. While, its basement was dominated by Mesozoic granitic rocks as a concurrence of regional granitic intrusion in Peninsular Malaysia during Triassic (Alexander, 1962). Suevite breccias in form of variable size boulders were found well scattered in the southern area of the Bukit Bunuh (Fig. 5).

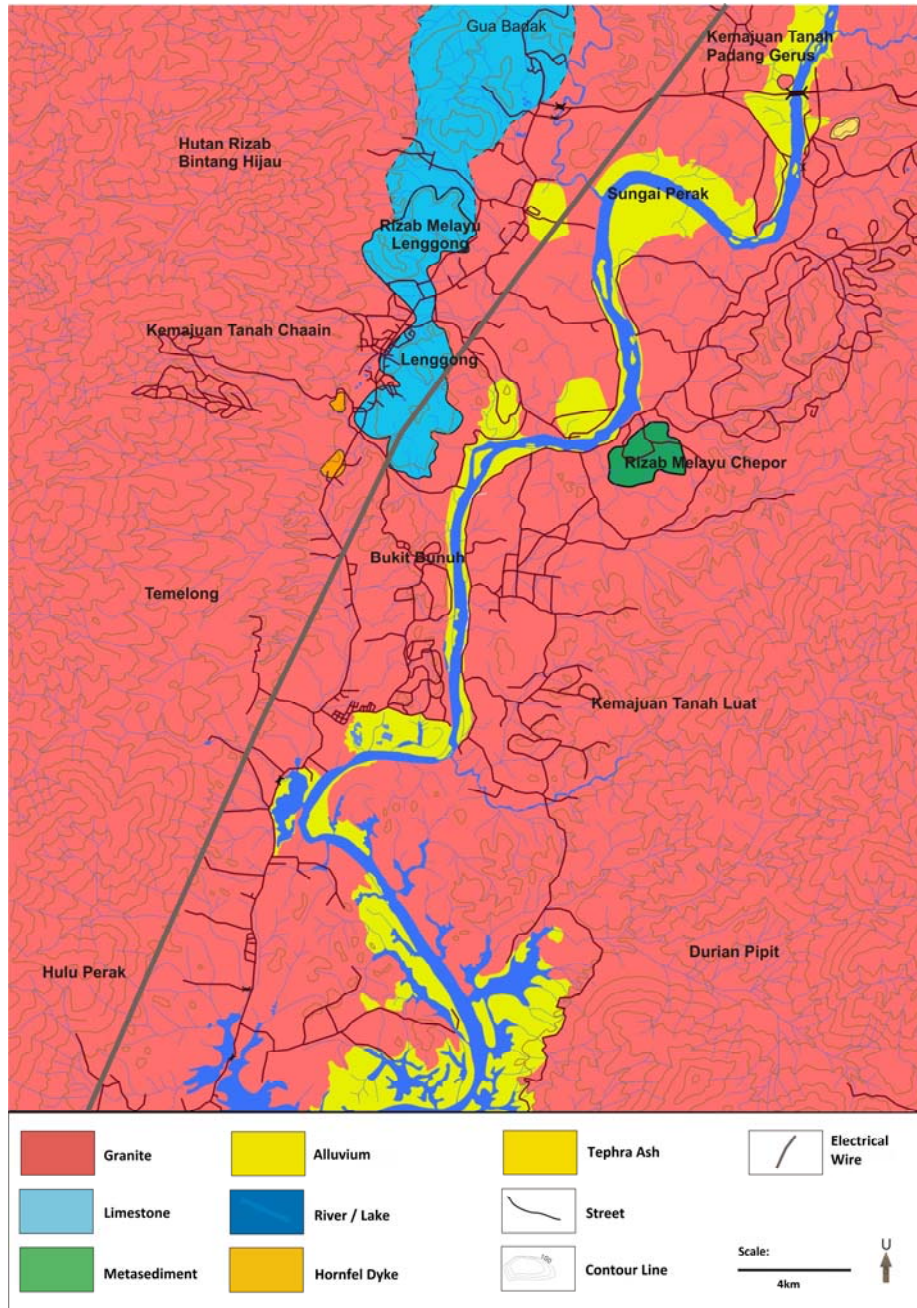

Figure 4: Geological map of Lenggong valley

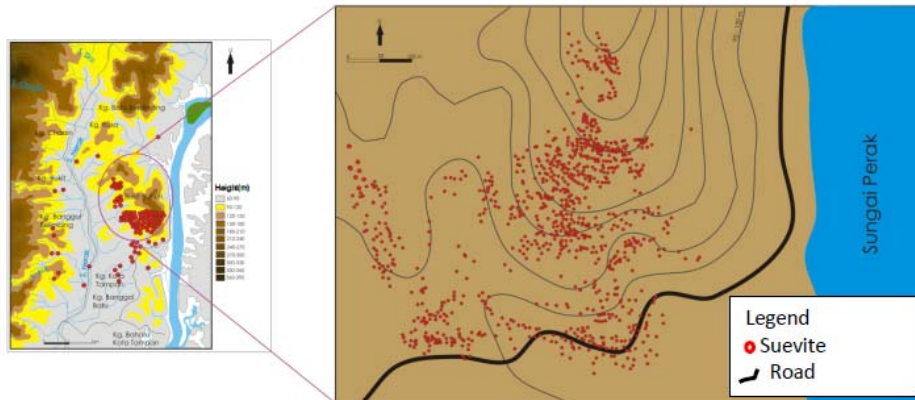

Figure 5: Map of suevite boulders

## 2. Methodology

The gravity survey was conducted using CG5 Scintrex Micro-Gravimeter. A total of 544 gravity stations had been established with approximately 500 m spacing in surrounding area and 50 m spacing in Bukit Bunuh (Fig. 6). The observed gravity data has been tied with an established gravity station (Loke, et al 1983). Wallcae and Ternian altimeters had been used to measure the elevation of gravity stations and the station coordinates determined by using global positioning system (GPS) instrument.

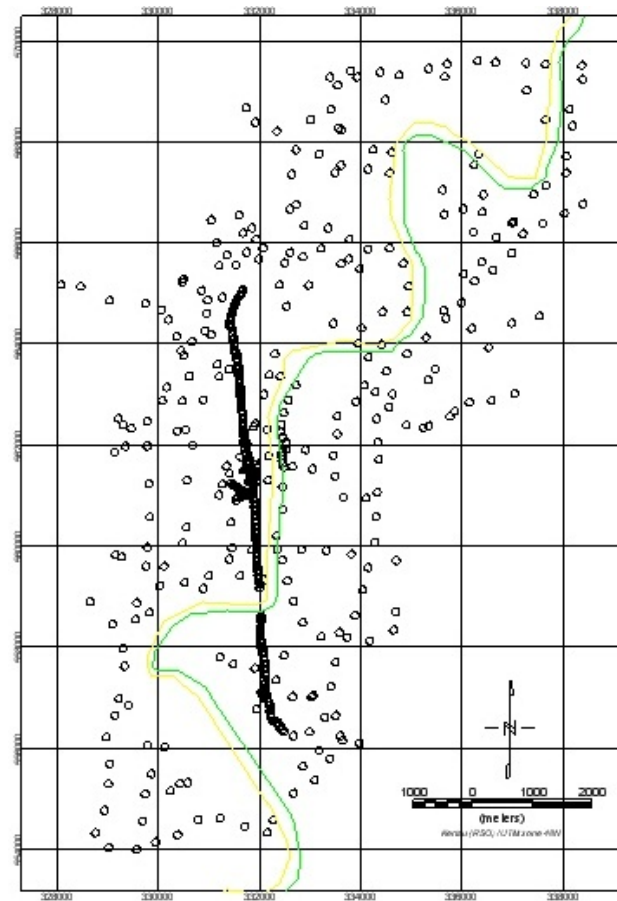

Figure 6: Map of observed gravity stations



The gravity data were corrected for drift, free air, bouguer, latitude and terrain in order to produce corrected bouguer anomaly data of the study area. The gravity data were then processed and analysed using Geosoft Oasis Montaj software to produce several gravity anomaly maps such as, bouguer, regional, residual, THD residual and THD regional anomaly maps, for qualitative and quantitative interpretation. Since about one fifth of known impact craters on Earth are covered with sediments, gravity is the major tool for investigation of these craters (Grieve and Pesonan, 1992). The gravity signature of impact craters is relatively distinctive and the relationship between impact effects and density is somewhat straightforward (Pilkington and Grieve, 1992).

### 3. Result and Discussion

Several anomaly gravity maps had been produced and interpreted by qualitative and quantitative analysis.

#### 3.1. Qualitative Analysis

The bouguer gravity anomaly map (Fig. 7) shows a negative low anomaly and some circular shaped in the study area.

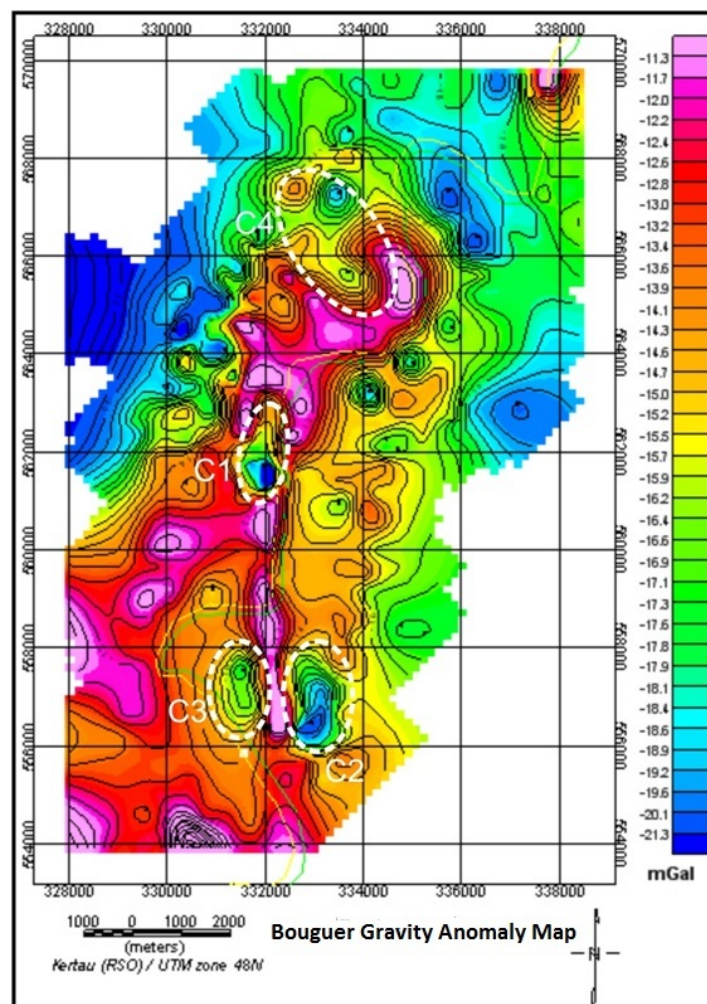

Figure 7: Bouguer gravity anomaly map of the study area

The map shows the occurrence of circular shaped in Bukit Bunuh area (C1). It surrounded by high anomaly with a diameter around 2.5km and interpreted as a remnant of meteorite impact crater. The low gravity anomaly is interpreted to be associated with low-density sedimentary fill, ejecta, and brecciated Suevite. Information from borehole data indicates that the subsurface geology at Bukit Bunuh area comprises of remnant of impact brecciated rocks (suevite) and weathered metasediments which are underlain by granitic rock basement. The bouguer anomaly map also shows the possible occurrences of three others impact craters (C2, C3, C4) located not very far to the northeast and southeast of the Bukit Bunuh impact crater. However, these structures need further detail investigation for confirmation.

Regional and residual gravity anomaly map had been produced to analysed subsurface structures. These maps were derivation of bouguer gravity anomaly map. Regional gravity anomaly map (Fig. 8a) shows the condition of basement. The anomaly tends to decreased in southwest-northeast direction. This indicated either the basement was shallower or alluvium sediment was thinner. Based on the surface geological condition, granite had been found in the southwest part of study area, therefore the first possibility is likely to be acceptable.

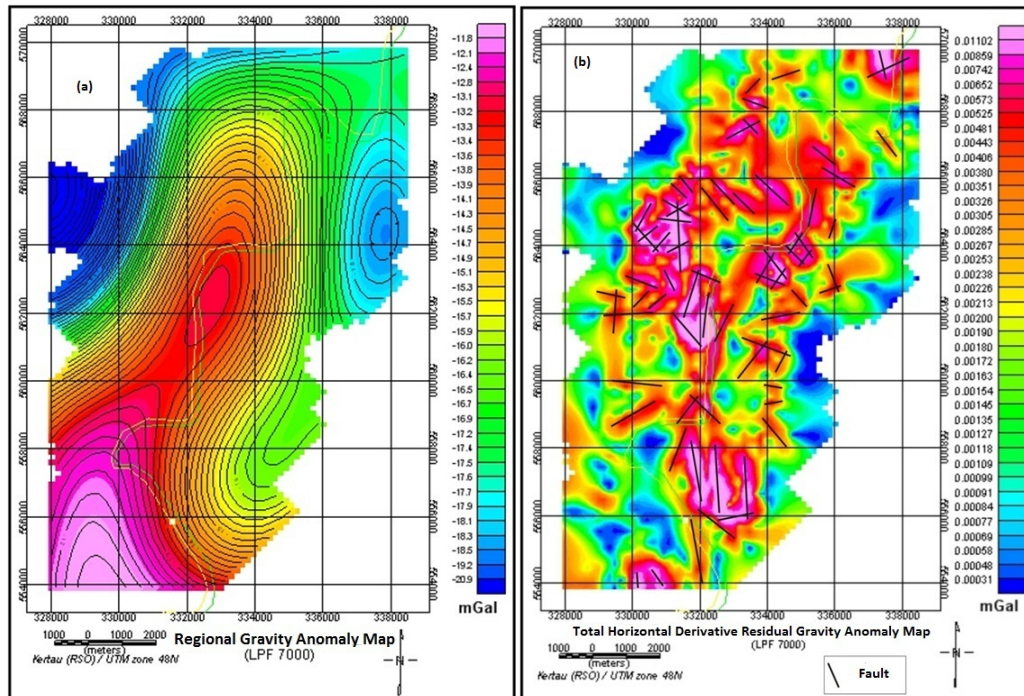

Figure 8: (a) Regional gravity anomaly map shows the condition of basement; (b) THD residual gravity anomaly maps shows the structure of shallower subsurface layer

Residual gravity anomaly map had been derived to produce Total Horizontal Derivative (THD) gravity anomaly map (Fig. 8b) that shows the structural condition of shallower subsurface layer. THD map shows the occurrence of lineaments and fault structures that concentrated in Bukit Bunuh and the direction is dominant to northwest-southeast. This data were supported by the result of rose diagram (Fig. 9) analysis that indicated the same dominant direction of the structures.

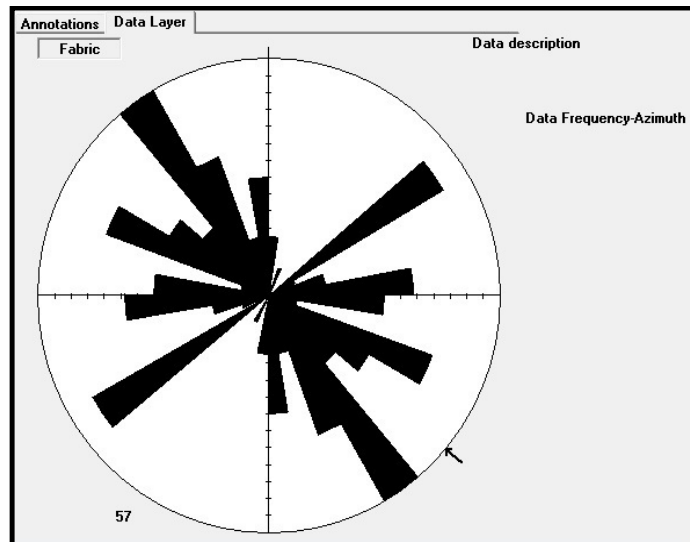

Figure 9: Rose diagram analysis indicated the dominant direction of lineaments and fault structures is northwest-southeast

### 3.2. Quantitative Analysis

An interpreted gravity model had been generated using GM-Sys 3D software. The model constructed based on several borehole data and bouguer gravity anomaly map of the study area. The 3D model (Fig. 10) shows the structure of impact crater is complex because of the occurrence of central uplifts.

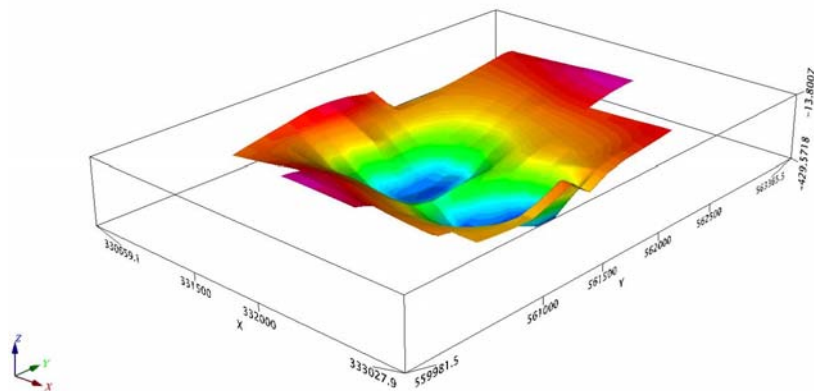

Figure 10: A 3D gravity models shows a complex crater structure with central uplifts

Based on this model, the diameter of impact crater approximately 2368 m and low density material including alluvium sediment, impact breccias (suevite) and metasediment with thickness about 400 m. The thickness of impact crater also could be determined from power spectrum analysis (Fig. 11) and the result had been displayed in a graphic that indicated the estimated layer and depth of impact crater. The graphic shows the subsurface structure divided into four section, 100 m, 130 m, 380 m and 400 m. The basement or the deepest part of impact crater had been interpreted belong to the last section. The 3D model of impact crater appears to tilt toward southeast direction (Fig. 12) suggesting the ancient meteorite that hit Bukit Bunuh area about 1.83 million years ago came from northwest direction.

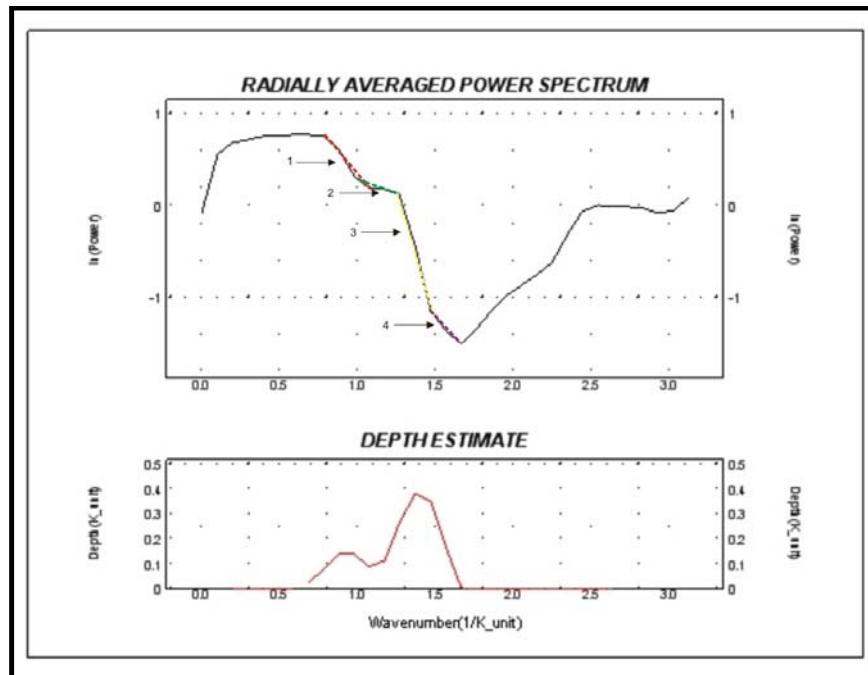

Figure 11: Power spectrum analysis to determine the estimated depth of impact crater

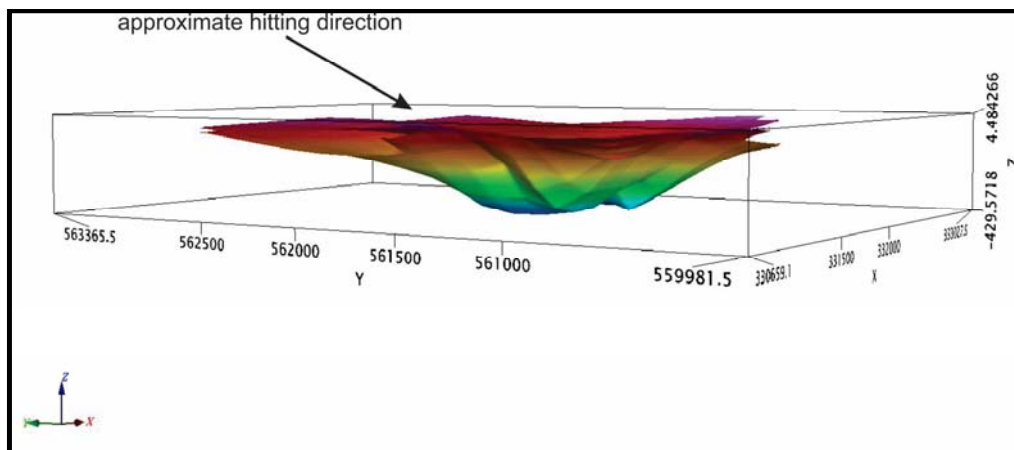

Figure 12: The direction of ancient meteorite that hit Bukit Bunuh 1.83 million years ago approximately came from northwest resulting the impact crater appears to tilt towards southeast direction

## References

- Alexander, J. B. (1962). A Short Outline of the Geology of Malaya with Special References to Mesozoic Orogeny. Geophysical Monograph Series, Vol. 6, pp.81-86. American Geophysical Union, United States.
- Grieve, R. A. & Pesonan, L. J. (1992). The Terrestrial Impact Crater Record. Tectonophysics, Vol. 216, pp.1-30. Elsevier.
- Loke, M. H., Lee, C. Y. & van Klinken, G. (1983). Interpretation of Regional Gravity and Magnetic Data in Peninsular Malaysia. Bulletin of The Geological Society of Malaysia, Vol. 16, pp.1-22. Geological Society of Malaysia, Malaysia.
- Parasnis, D. S. (1986). Principle of Applied Geophysics, Chapman and Hall, New York, United States.

- Pilkington, M. & Grieve, R. A. (1992). The Geophysical Signature of Terrestrial Impact Crater. *Reviews of Geophysics*, Vol. 30, pp.161-181. Wiley Blackwell. United States.
- Samsudin, A. R. (1990). *Geofizik Konsep dan Penggunaan*, Dewan Bahasa dan Pustaka, Kuala Lumpur, Malaysia.

Topic : Socioeconomic Relations

## Introducing A Threshold To Condorcet Improvement

Fumihiro Kaneko<sup>1</sup>

*Faculties of Law, Politics and Economics, Chiba University, 1-33 Yayoi-cho, Inage-ku, Chiba-shi, Chiba, 263-8522, Japan*

---

### Abstract

For the case of three alternatives, an elementary extension of the system of axioms for the Condorcet Improvement is presented in order to expand the indecision region for pairwise voting vectors beyond uniform cycles, The resulting modification of the Condorcet Improvement criterion on pairwise votes is derived. The Condorcet Improvement is the decision criterion on pairwise voting vectors which modifies the Condorcet winner criterion by expanding winner regions over cyclic votes in a manner that the intensity of preference on a pair of alternatives by voters is reflected. In the extension, an axiom is added to eliminate a small influence by a particular type of perturbation on cyclic profiles that intends to discriminate against an alternative by dropping it from the set of candidates for a winner by the Condorcet Improvement. A threshold is used in this axiom in order to identify such a small influence. Graphically in the space of pairwise votes, the extension makes the indecision region to be a triangular swelling of the line segment that is the indecision region of the Condorcet Improvement without a threshold. The winner regions are reduced by eliminating pairwise voting vectors that belong to the expanded indecision region. This article is an abbreviated presentation of the main result in Kaneko (2016).

### Keywords

Pairwise voting; Positional voting; Condorcet winner; Borda rule; Decision with thresholds

---

### 1. Introduction

This article is an abbreviated presentation of the main result in Kaneko (2016), which gives an axiomatic foundation for introducing a threshold to the Condorcet Improvement which intends to expand the indecision region for pairwise voting vectors beyond uniform cycles and derive its consequent modification of the Condorcet Improvement criterion on pairwise vote, for the case of three alternatives. The cyclic coordinate system is used to identify “almost” confused voters, which are non-confused only by discriminating against an alternative slightly. Given a positive threshold less than  $\frac{2}{3}$ , the system of axioms for the Condorcet Improvement is extended with an axiom that an “almost” confused voters with a level of discrimination no more than the threshold is identified with a confused voter. It is proved that, under the extended system of axioms, the indecision region is expanded to a triangular swelling of the line segment  $\left[ \left( -\frac{1}{3}, -\frac{1}{3}, -\frac{1}{3} \right), \left( \frac{1}{3}, \frac{1}{3}, \frac{1}{3} \right) \right]$ , which is the indecision region for Condorcet Improvement without the threshold.

---

1 Corresponding author. Tel.: +1-81-43-290-3584; fax: +1-81-43-290-3584.  
E-mail address: fkaneko@le.chiba-u.ac.jp

The Condorcet Improvement (abbreviated as CI hereafter) is the decision criterion on pairwise voting which modifies the Condorcet winner criterion by expanding winner regions over cyclic votes in a manner that the intensity of preference on a pair of alternatives by voters is reflected. An axiomatic foundation of the Condorcet Improvement is given in Saari (1994) and Saari (1995) for the case of three alternatives. A crucial axiom implies that the region of cyclic votes is partitioned according to a count of preference intensity exhibited in the ranking of alternatives by each voter. It turns out that the Condorcet Improvement is equivalent to the social outcome mapping based on the Borda rule, a particular positional voting method with a symmetric scoring vector.

The role of a threshold in expanding the indecision region of CI is to make a winner robust to a small perturbation of a profile of voters by “almost” confused voters. Since CI generically calls a winner even if a pairwise voting vector is cyclic, any voter who is arbitrarily close to a confused voter can be pivotal. Such a voter can be considered to be a disguise of a confused voter. A disguise has a minimal effect on the selection of a winner if only one alternative is dropped out of being a winner, since the set of candidates for a winner is minimally affected. However, if such disguises are made simultaneously, the pairwise voting vector is generically moved to a winner region of CI. A threshold is used to neutralize a disguise of a confused voter by dropping an alternative from candidates of a winner to a confused voter, in order to eliminate a vulnerability of a winner by simultaneous disguises of a confused voter.

Throughout the analysis, use is made of the cyclic coordinate system for pairwise voting, which is introduced in Saari (1994) and Saari (1995). It represents a profile in view of a grouping of voter types into two groups, each of which creates either a positive or a negative cycle in pairwise voting.

The article is organized as follows. The relevant outset of voting theory and the voting maps, one for pairwise voting and the other for positional voting, are reviewed briefly in the section 2. The expansion of the indecision region by introducing a threshold to CI is presented in the section 3. Remarks on issues related to the result are given in the section 4.

## 2. Outset and Pairwise Voting Map

First, I briefly introduce the outset and the voting maps of concern, which are all taken from Saari (1994) and Saari (1995). In the following, the (l-1)-dimensional basic simplex in the Euclidean space  $\mathbb{R}^l$  is denoted by  $\Delta^{l-1}$ .

Throughout the article, it is assumed that there are three alternatives. The set of alternatives is  $\{c_1, c_2, c_3\}$ . It is assumed that each voter has a strict ordering on the alternatives. There are total  $3! = 6$  strict orderings of alternatives, and they are numbered as in the table 2.1.

Number	Type of strict ordering
1	$c_1 > c_2 > c_3$
2	$c_1 > c_3 > c_2$
3	$c_3 > c_1 > c_2$
4	$c_3 > c_2 > c_1$
5	$c_2 > c_3 > c_1$
6	$c_2 > c_1 > c_3$

Table 2.1. Strict orderings on alternatives

A tuple of strict orderings on alternatives across all voters is called a profile. A strict ordering corresponds to a type of voters. A profile can be represented as a vector in  $\Delta^5$  whose components show the ratio of voters for each type. A profile represented as such is denoted by  $p$ . For  $j \in \{1,2,3,4,5,6\}$ ,  $p_j$  is the ratio of the voters of type  $j$ .

The pairwise voting map is defined as follows. Let ordered pairs of alternatives be numbered as in the table 2.2.

Number	Ordered pair of alternatives
1	$(c_1, c_2)$
2	$(c_2, c_3)$
3	$(c_3, c_1)$

Table 2.2. Pairs of alternatives

A pairwise voting vector is a vector  $q \in [-1,1]^3$ , where  $q_i$  is a relative vote for the first alternative to the second one in the pair of alternatives indexed by  $i$ , for  $i \in \{1,2,3\}$ . The pairwise voting map associates a profile with pairwise voting vector. Specifically, it is a map  $F_3: \Delta^5 \rightarrow [-1,1]^3$  defined by

$$F_3 \equiv \left( \sum_{j=1.2.3} p_j - \sum_{j=4.5.6} p_j, \sum_{j=1.5.6} p_j - \sum_{j=2.3.4} p_j, \sum_{j=3.4.5} p_j - \sum_{j=1.2.6} p_j \right).$$

Its image is a subset of  $[-1,1]^3$  between two planes,  $\sum_{i=1,2,3} q_i = 1$  and  $\sum_{i=1,2,3} q_i = -1$ , and is denoted by  $ImF_3$ .

A pairwise vote has a one-to-one relationship with a normalized Borda rule vote, and in fact CI is equivalent to the Borda rule voting. Hence the threshold imposed on CI can be transferred to the positional voting methods. A positional voting vector is a vector  $v \in \Delta^2$ , where  $v_j$  denotes the total score for the alternative  $c_j$  for  $j \in \{1,2,3\}$ . A normalized scoring vector is a vector  $w_s \equiv (1 - s, s, 0)$  for a  $s \in [0, \frac{1}{2}]$ . For  $k \in \{1,2,3\}$ , the  $k$ -th component of  $w_s$  is the score given to the  $k$ -th ranked alternative. The positional voting map associates a couple of a profile and a scoring vector with a positional voting vector. Specifically, it is a map  $f: \Delta^5 \times [0, \frac{1}{2}] \rightarrow \Delta^2$  defined by

$$f(p, s) \equiv \sum_{j=1}^6 p_j [w_s]_j,$$

where  $[w_s]_j$  is a vector obtained by a permutation of the components of  $w_s$  according to the strict ordering of alternatives indexed by  $j$ , for each  $j \in \{1,2,3,4,5,6\}$ . They are shown in the table 2.3.

Permuted scoring vector	Vector in the component form
$[w_s]_1$	$(1 - s, s, 0)$
$[w_s]_2$	$(1 - s, 0, s)$
$[w_s]_3$	$(s, 0, 1 - s)$
$[w_s]_4$	$(0, s, 1 - s)$



Permuted scoring vector	Vector in the component form
$[w_s]_5$	$(0, 1 - s, s)$
$[w_s]_6$	$(s, 1 - s, 0)$

Table 2.3. Permuted scoring vectors

Given a  $s \in \left[0, \frac{1}{2}\right]$ , the image of the map  $f_s \equiv f(\cdot, s)$ , denoted by  $Imf_s$ , is a convex hull spanned by vectors  $\{[w_s]_j\}_{j=1,2,3,4,5,6}$ . The Borda rule voting corresponds to  $s = \frac{1}{3}$ . The plurality voting corresponds to  $s = 0$ , while the anti-plurality voting corresponds to  $s = \frac{1}{2}$ .

### 3. An Axiomatic Foundation of CI with a Threshold

The purpose of developing CI with or without a threshold is to partition  $ImF_3$  into the following regions;

$D_i (i = 1, 2, 3)$ :  $c_i$  wins,

$D_{i,i+1} (i = 1, 2, 3, \text{ mod } 3)$ :  $c_i$  and  $c_{i+1}$  are tied at the top,

$E$ : no winner is decided.

CI without a threshold introduces a set of axioms on which these regions are identified as an acceptable modification of the Condorcet winner criterion. I introduce a threshold of size  $\varepsilon$  into CI for reducing the influence of “almost” confused voters in a profile. Confused voters are profiles making cyclic votes. In  $ImF_3$ , the direct influence of confused voters appears on the line segment  $\left[\left(-\frac{1}{3}, -\frac{1}{3}, -\frac{1}{3}\right), \left(\frac{1}{3}, \frac{1}{3}, \frac{1}{3}\right)\right]$ , which is the indecision region for CI without a threshold. By introducing a threshold, the indecision region must be expanded to include the line segment in its interior.

In Saari (1994) and Saari (1995), a coordinate system on the set of profiles based on pairwise voting vectors, called as the cycle coordinate system, is introduced. It helps for identifying effects of positive and negative confused voters in the pairwise voting. The cyclic coordinate of a profile  $p$  is a tuple  $(\alpha(p), \beta(p), d(p))$ , where

$$\alpha(p) = F_3 \left( \left( \frac{p_1}{p_1+p_3+p_5}, 0, \frac{p_3}{p_1+p_3+p_5}, 0, \frac{p_5}{p_1+p_3+p_5}, 0 \right) \right),$$

$$\beta(p) = F_3 \left( \left( 0, \frac{p_2}{p_2+p_4+p_6}, 0, \frac{p_4}{p_2+p_4+p_6}, 0, \frac{p_6}{p_2+p_4+p_6} \right) \right) \text{ and}$$

$$d(p) = p_1 + p_3 + p_5.$$

By letting  $T_1 \equiv \{q \in ImF_3 \mid \sum_{j=1,2,3} q_j = 1\}$  and  $T_{-1} \equiv \{q \in ImF_3 \mid \sum_{j=1,2,3} q_j = -1\}$ ,  $\alpha(p) \in T_1$  and  $\beta(p) \in T_{-1}$ . The map defined by  $(\alpha, \beta, d)$  is one-to-one except for profiles for which the sum of components for the value by  $F_3$  is either 1 or -1. For such profiles, either  $\alpha$  or  $\beta$  can be neglected in an obvious way. It is clear that  $F_3(p) = d(p)\alpha(p) + (1 - d(p))\beta(p)$ .

The positive confused voter  $p^c_+$  is the profile  $(\frac{1}{3}, 0, \frac{1}{3}, 0, \frac{1}{3}, 0)$ , and the negative confused voter  $p^c_-$  is the profile  $(0, \frac{1}{3}, 0, \frac{1}{3}, 0, \frac{1}{3})$ . Any convex combination of these profiles is called as a confused voter. The former is a unique profile that has the value of  $F_3$  to be  $(\frac{1}{3}, \frac{1}{3}, \frac{1}{3})$ , while the latter is a unique profile that has the value of  $F_3$  to be  $(-\frac{1}{3}, -\frac{1}{3}, -\frac{1}{3})$ . The difference between  $\alpha(p)$  and  $(\frac{1}{3}, \frac{1}{3}, \frac{1}{3})$  is a measure for the degree of freedom from the positive confused voter, and that between  $\beta(p)$  and  $(-\frac{1}{3}, -\frac{1}{3}, -\frac{1}{3})$  is that from the negative confused voter. It is intended that a threshold is used to identify a profile  $p$  for which each of  $\alpha(p)$  and  $\beta(p)$  are close to positive or negative confused voters, correspondingly.

An axiom for CI without a threshold claims that, if a profile consists of voter types for which an alternative is ranked at the bottom and the other two alternatives are tied in the pairwise vote, then it must be decided that those two alternatives are tied at the top. A confused voter can be perturbed in any small degree to make two alternatives dominate another but are tied each other. A threshold is used to guarantee that such a perturbation does not rank any alternative bellow others socially if the size of perturbation is small. All confused voters are treated equally, so that the effect of a threshold must be uniform over confused voters. Based on this argument, Kaneko (2016) proposes the following set of axioms to refine CI with a threshold  $\epsilon$ .

**Axiom 1.** For each  $i \in \{1,2,3\}$ ,  $D_i$  is an open convex set. For each  $i \in \{1,2,3\} \pmod{3}$ .  $D_{i,i+1}$  is a subset of the intersection of boundaries of  $D_i$  and  $D_{i+1}$  and a convex set.  $E$  is a closed convex set.

**Axiom 2.** The set  $D_1 \cup D_2 \cup D_3 \cup E$  is dense in  $ImF_3$ .

**Axiom 3.** For each  $i \in \{1,2,3\}$ , let  $C_i$  be the set of all pairwise voting vectors for which the alternative  $c_i$  is the winner by CI without a threshold. Then  $D_i = C_i \setminus E$  for all  $i \in \{1,2,3\}$ .

**Axiom 4.** For some  $\epsilon \in (0, \frac{2}{3})$ , the following statements hold.

**4.1.** Let  $p^{c_+}(i, \lambda)$  ( $p^{c_-}(i, \lambda)$ ) be the profile obtained by modifying the positive (negative) confused voter in the way that the type which ranks  $c_i$  at the bottom is increased by  $\frac{\lambda}{2}$  and the type which ranks  $c_i$  at the top is reduced by  $\frac{\lambda}{2}$ . Then  $F_3(p^{c_+}(i, \lambda))$  ( $F_3(p^{c_-}(i, \lambda))$ ) belongs to  $E$  if and only if  $\lambda \leq \epsilon$ .

**4.2.** If a profile  $p$  satisfies  $\alpha(p) = \alpha(p^{c_+}(i, \lambda))$  and  $\beta(p) = \beta(p^{c_-}(i, \lambda))$ , then  $F_3(p)$  is in  $E$  if and only if  $\lambda \leq \epsilon$ .

**4.3.** For a profile  $p$ , let  $p^c$  be the profile having the cycle coordinate  $(\alpha(p^{c_+}), \beta(p^{c_-}), d(p))$ . Also, for each  $i \in \{1,2,3\}$ , let  $p^c(i, \lambda)$  be the profile having the cycle coordinate  $(\alpha(p^{c_+}(i, \lambda)), \beta(p^{c_-}(i, \lambda)), d(p))$ . Then, if  $F_3(p) \in C_i$ ,  $F_3(p) \in E$  if and only if  $F_3(p)$  is non-negatively spanned by  $F_3(p^c)$ ,  $F_3(p^c(i+1, \epsilon))$  and  $F_3(p^c(i+2, \epsilon)) \pmod{3}$ .

With this set of axioms, Kaneko (2016) derives the following refinement of CI.

**Theorem.**

A partition of  $ImF_3$  into  $D_i$  ( $i=1,2,3$ ),  $D_{i,i+1}$  ( $i \in \{1,2,3\} \pmod{3}$ ) and  $E$  satisfies the axioms 1-4 if and only if these sets are determined as follows;

$$E = \{d\alpha + (1 - d)\beta \mid \alpha \in \widehat{T}_1, \beta \in \widehat{T}_{-1}, d \in [0,1]\},$$

$$D_i = C_i \setminus E \quad (i=1,2,3),$$

$$D_{i,i+1} = (bd(C_i) \cap bd(C_{i+1})) \setminus E \ (i \in \{1,2,3\}, \text{mod } 3).$$

where  $bd(C_i)$  is the boundary of  $C_i$  in  $ImF_3$  for  $i=1,2,3$ , and

$$\widehat{T}_1 = \text{thetrianglewithvertices} \left( \frac{1}{3}, \frac{1}{3} + \epsilon, \frac{1}{3} - \epsilon \right), \left( \frac{1}{3} - \epsilon, \frac{1}{3}, \frac{1}{3} + \epsilon \right), \left( \frac{1}{3} + \epsilon, \frac{1}{3} - \epsilon, \frac{1}{3} \right),$$

$$\widehat{T}_{-1} = \text{thetrianglewithvertices} \left( -\frac{1}{3}, -\frac{1}{3} + \epsilon, -\frac{1}{3} - \epsilon \right), \left( -\frac{1}{3} - \epsilon, -\frac{1}{3}, -\frac{1}{3} + \epsilon \right), \\ \left( -\frac{1}{3} + \epsilon, -\frac{1}{3} - \epsilon, -\frac{1}{3} \right).$$

In Saari (1994) and Saari (1995), it is derived that

$C_i = \{q \in ImF_3 \mid 2q_i > q_{i+1} + q_{i+2}, 2q_{i+2} < q_i + q_{i+1}\} \pmod{3}$ , for each  $i \in \{1,2,3\}$ . On the section of  $ImF_3$  by the plane  $\{q \mid \sum_{i=1,2,3} q_i = t\}$  ( $t \in [-1,1]$ ),  $E$  becomes the closed triangle with vertices  $\left(\frac{t}{3}, \frac{t}{3} + \epsilon, \frac{t}{3} - \epsilon\right)$ ,  $\left(\frac{t}{3} - \epsilon, \frac{t}{3}, \frac{t}{3} + \epsilon\right)$  and  $\left(\frac{t}{3} + \epsilon, \frac{t}{3} - \epsilon, \frac{t}{3}\right)$ . The rest of the partition on the section can be easily figured out with these.

The proof of the theorem in Kaneko (2016) derives the partition on the section directly by an elementary calculation. Let  $H_t$  be the intersection of  $ImF_3$  and the plane  $\{q \mid \sum_{i=1,2,3} q_i = t\}$ . Consider any profile  $p$  such that  $F_3(p) \in H_t$ . It is trivial to see that  $d(p) = \frac{1+t}{2}$  for such profiles, so that they have the same  $d$ -coordinate. An elementary calculation shows that  $F_3(p^c_{+(i-1, \lambda)}_{i+k}) = 1/3 + k\lambda$  for  $i \in \{1,2,3\}$  and  $k \in \{-1,0,1\} \pmod{3}$ . Similarly,  $F_3(p^c_{-(i-1, \lambda)}_{i+k}) = -(1/3) + k\lambda$  for  $i \in \{1,2,3\}$  and  $k \in \{-1,0,1\} \pmod{3}$ . Therefore, we have  $F_3(p^c(i-1, \lambda))_{i+k} = \frac{t}{3} + k\lambda$  for  $i \in \{1,2,3\}$  and  $k \in \{-1,0,1\} \pmod{3}$ . Let  $\widehat{H}_i \equiv \{q \in ImF_3 \mid 2q_i = q_{i+1} + q_{i+2} \pmod{3}\}$  for  $i=1,2,3$ . Then  $F_3(p^c(i-1, \lambda)_i)$  is in  $\widehat{H}_i$  and not in  $C_i$ . Since  $F_3(p^c(i-1,0)) = F_3(p^c) = \left(\frac{t}{3}, \frac{t}{3}, \frac{t}{3}\right)$ ,  $\lambda \leq \frac{2}{3}$  guarantees that  $F_3(p^c(i-1, \lambda))$  is in  $bd(C_i) \cap bd(C_{i+1}) \cap H_t$ . By the axiom 3 and 4,

$$D_i \cap H_t = [C_i \cap H_t] \\ \setminus \text{thetrianglewithverteces} \left( \frac{t}{3}, \frac{t}{3}, \frac{t}{3} \right), F_3(p^c(i-1, \epsilon)), F_3(p^c(i+1, \epsilon))$$

$\pmod{3}$ . By the axiom 1 and 2,

$\pmod{3}$ .

They imply that

$$E \cap H_t = \text{theclosedtrianglewithverteces} \left( \frac{t}{3}, \frac{t}{3} + \epsilon, \frac{t}{3} - \epsilon \right), \left( \frac{t}{3} - \epsilon, \frac{t}{3}, \frac{t}{3} + \epsilon \right), \left( \frac{t}{3} + \epsilon, \frac{t}{3} - \epsilon, \frac{t}{3} \right).$$

The theorem follows easily by integrating these sets for  $t \in [-1,1]$ , or along the line segment  $\left[ \left(-\frac{1}{3}, -\frac{1}{3}, -\frac{1}{3}\right), \left(\frac{1}{3}, \frac{1}{3}, \frac{1}{3}\right) \right]$ .

#### 4. Remarks

Kaneko (2016) includes more results related to the theorem. It proposes that, for all scoring voting methods, the image of the expanded indecision region for CI by the one-to-one map from a pairwise voting vector to a scoring voting vector with the normalized Borda scoring vector is adopted as the indecision region, though the maximal translation is proved to be larger than that for non-Borda scoring methods. But it is proved that, by doing so, the threshold value for a pairwise voting on a pair of alternatives which guarantees that a scoring

voting method avoids the indecision is maximized at the normalized Borda method, so that CI discredits the Borda method more than other scoring methods. Another use of a threshold to expand indifference regions in which two alternatives are tied at the top is considered in the article, and it turns out that such a use of threshold does not translate to a meaningful elimination of perturbations by confused voters that misrepresent the preference intensity for two alternatives. A perturbation that a confuse voter breaks a tie between  $c_1$  and  $c_2$  for  $c_1$ 's win by CI is a convex combination of  $(\frac{1}{2}, 0, \frac{1}{2}, 0, -1, 0)$  and  $(0, 1, 0, -\frac{1}{2}, 0, -\frac{1}{2})$ , scaled by a small positive number. In both perturbation profiles, the preference intensity of  $c_1$  over  $c_2$  increases without affecting the vote on a pair  $\{c_1, c_2\}$ . This perturbation of a profile breaks a tie between  $c_1$  and  $c_2$  by moving the pairwise voting vector to the direction  $(2, -1, -1)$  by the small scale, which is a normal vector for the plane dividing  $C_1$  and  $C_2$  that heads toward  $C_1$ . But such a perturbation of a pairwise voting vector is also created by the perturbation profile  $(-1, -\frac{1}{2}, \frac{1}{2}, -\frac{1}{2}, \frac{1}{2}, 1)$  scaled by the same small positive number. This perturbation profile does not manipulate the preference intensity of  $c_1$  over  $c_2$  at all. A perturbation by a misrepresenting confused voter leads to a profile with a negative ratio for some type if a perturbed profile gives a tie between  $c_1$  and  $c_2$  by a pairwise voting vector close to the boundary of  $ImF_3$ , since a type that a misrepresenting confused voter reduces is scarce in such a profile.

The introduction of a threshold into the decision theory for expanding the indecision region is unpopular in two reasons. One is that a threshold are given by the outset and not chosen optimality on some criterion. The other is that the decision theorists are occupied with how to decide, not how to force the indecision. The former is the common problem for all social decision with a threshold. An optimization of a threshold level requires a social interaction of voters other than the voting itself, and it would affect strategically on their voting behaviour. The latter depends on an issue to be voted at hand. If voters are choosing a congressman, a winner must be decided, otherwise registration procedures in the congress are severely restricted and all voters suffer from that. However, if voters are choosing a long-term social investment on infrastructures whose true benefits and costs have not been fully revealed yet,, there is no urgency to decide until a sufficient information on them becomes available.

## References

- Kaneko, F. (2016) A Refinement of the Condorcet Improvement with a Threshold, Economic Journal of Chiba University, Vol.30, No.2, pp.135-175.
- Saari, D. (1994) *Geometry of Voting*, Springer-Verlag, Berlin.
- Saari, D. (1995) *Basic Geometry of Voting*, Springer-Verlag, Berlin.

**Topic :**add selected topic listed in website here

## **The Idea of Multicultural Interconnective with Socio-Religious Values at Trans *Dalam* Community in Pulang Pisau Regency**

Dr. Abdul Qodir<sup>1</sup>

*Vice Rector 1 on Academic Support and Development, State Islamic Institute (IAIN) of Palangka Raya, Jl. G. Obos Komplek Islamic Center No. 24, Palangka Raya 73112, Indonesia*

---

### **Abstract**

This study was aimed at describing a growing multicultural awareness phenomenon which is connected with socio-religious values in a transmigrated community of Trans *Dalam*, Pulang Pisau regency. This study focused on how this phenomenon develops and its background be tracked back. The theory of motivation need for security and the fulfillment of social interaction are major consideration to understand this phenomena. The data were collected through in-depth interviews and field observation technique which are endorsed by the methods of triangulation with data sources and finally the collected data were analysed inductively. The results showed that transmigrated villagers demonstrate identically high motivation to preserve the multicultural awareness, especially ideas to live together in harmony.

Intrinsically, transmigrated community members displayed strong passion and high need for achievement in work and education which appeared on their vibrant nature of togetherness, mutual respect, social solidarity called *silaturahmi* with fellows from different background of ethnics and religions. The passion to help others grew and developed along with the social comfort within inhabitant. They were encouraged to solve social problem together in a congregated meeting. They have held this way of life since 30 years ago and live in peace and harmony while collectively maintaining socio-religious connection and external factors (environment).

Sociologically, the support of community leaders and religious leaders confirmed the desire of citizens to live peacefully. Social support system to fellow citizens without discriminating different ethnic and religious origins. The system was maintained to encourage *gotongroyong* (togetherness) in order to help each other in needs, to smoothly minimize opinion divergent, and to foster tolerance, and mutual *silaturahmi* (social respect). Moreover local government system was an instrumental element to optimize security and social order are monitored by security districts.

### **Keywords**

Value of Socio-Religious, Multicultural Awareness, Transmigrated Community

---

<sup>1</sup> Telp. Fax: +62 536 3222105.

E-mail address: [wr1@iain-palangkaraya.ac.id](mailto:wr1@iain-palangkaraya.ac.id); [abdulqodirjanah@gmail.com](mailto:abdulqodirjanah@gmail.com); Phone: +62 81349775351

## **1. Introduction**

Multicultural ideas have been discussed in many scientific forums. The ideas are also written and analyzed by the experts as well, either comparatively or critically in many papers including those with empirical basis. In spite of that fact, the multiculturalism is not exposed enough, particularly in empirical studies, especially held in rural areas in which it grows, develops and interconnects in socio-religious values. Multicultural can be conceptually learned from *Bhinneka Tunggal Ika* with its idea of socio-religious interconnection in life.

## **2. Focus on the Study**

The empirical study in in rural area reflects the development of multicultural characteristic which needs to be explained, even though from the early stage. This stage will focus on: How and why the multicultural values can develop in Trans Dalam society?

There are many important multicultural ideas we need to understand, because we live in a very huge area and the diversity in its people. This diversity of cultures can be seen and found where we interact with people in workplaces and/or in educational institutions. Furthermore, the multicultural ideas may grow and develop in these places an also in some communities in the society.

## **3. Theoretical Studies**

Multiculturalism is derived from "*multi*" which means plural, "*cultural*" which means culture, and "*isme*" which means ideology.<sup>2</sup> Through the understanding of multiculturalism, the ideas an understanding ways to accommodate the different beliefs in society or community using the concept of supporting of the existence of tolerance, social harmony, and cooperation for good in various behaviors.

Friendly and helpful behavior will make people achieve the harmony in togetherness. Moreover, feelings of being in the same boat of nation in a wide national area with its valuable assets is a potential for the formation of the solidarity aimed by reflecting *Tunggal Ika*.

Based on the observation of the respect people show towards the diversity in race can be seen on the aspects in life and behavioral actions in daily basis, such as:

1. The harmony in life by the concord in a family.
2. Among the society, spirit off helping each other, the cooperation in solving problems.

---

<sup>2</sup> Abdul Munir Mulkan, *Monocultural versus Multicultural approaches*, (Yogyakarta: SI Press, 1996), hal. 205.

3. Solving problems in society by considering the deliberation.
4. The awareness of putting the public interest first above the personal and group orientation interest.<sup>3</sup>

Beside those significant ideas, the other important thing is that knowing the particular prominent figures who socialize multicultural ideas. There are handful of them, they show people what multicultural is and also voice the idea of human rights, the freedom in thinking, and also talk about cross cultural religious dialogs. They are Tilaar, Abdurrahman Wahid (Gus Dur) who familiarize the idea of indigene of Islam, Nurkholis Madjid, with the idea of Islam cosmopolitanism, who is also voices the democracy and pluralism as the basis of the multicultural society.

Other than those, Abdul Munir Mulkan is also a figure who talks about the relation of religion and multiculturalism. There are also younger figures among them, such as Masdar Farid Mas'udi, Ulil Abshar Abdalla, Muqshid Ghazali, Budi Munawar Rachman, Zultan Misrawi, and Lutfi Assaukanie. They support the multiculturalism ideas and voice their idea in democracy in politic, pluralism in society....<sup>4</sup> So, multicultural simply means the diversity which mainly concerns about the willingness of accepting other people regardless the difference.

There are three terminologies, plurality, diversity, and multicultural are used regularly and alternatively to describe the society with differences in its people, such as religion, race, language, and culture.<sup>5</sup>

These three terminologies don't represent the same thing, even though all of them hint to plurality. Plurality concept shows the things that are more than one. This diversity shows that more than one thing means they are different, heterogenic, and cannot be treated the same way. Compare to those two concepts, multiculturalism is relatively new.<sup>6</sup>

Furthermore, Iskandar Zulkarnain explains, that conceptually there is a significant difference between plurality, diversity and multiculturalism. Multiculturalism is the idea of respecting and accepting any communities towards each other despite of the cultures, ethnics, genders, languages, and religions.

If the plurality represents the plural things, then multiculturalism asserts that in every differences, visible or not, has the same portion in public and in society.

---

<sup>3</sup> MPR RI and socialization team for four pillars of nation, 2013, page 11.

<sup>4</sup> Abdul Munir Mulkhan, Monocultural versus Multicultural approaches, page. 195

<sup>5</sup> *Ibid.*, hlm. 4.

<sup>6</sup> Iskandar Zulkarnaen, Multicultural Dakwah, paper presented on Visiting Lecture Session in STAIN Palangka Raya, 2013.

Multiculturalism becomes a response of the new policy towards the community diversities in which are different but also being treated fairly by the country.

Furthermore, multiculturalism means the acknowledgement of *politics of recognition* towards the differences as the entity in society in which needs to be accepted, valued, protected, an ensured of its existence.<sup>7</sup>

By applying the togetherness-sociocultural in life, the social order in society can develop in many aspects. The advancement will be easy to achieve in conducive situation, so the idea of togetherness, respecting each other, betterment, highly motivated and good ethos can raise the awareness of multicultural society in life. Here is the explanation to understand better what multicultural life is.

#### **4. Multicultural Ideas and Its Assessment**

When an idea of multiculturalism is successful or not in the implementation can be seen from the development in the field. Assessing the implementation is not easy, because of the scope of multiculturalism idea and its implementation which is casuistic. It means that it varies and is influenced by the situation and condition of the society itself. Furthermore, the needs of understanding the concept and characteristics of multicultural idea and observation towards the object when conflict cases and problem solver itself appear.

....multicultural education is successful when the process involve every element in society. Tangibly, the education does not involve only particular community or the government but also all of the elements. It is caused by the multidimensional in every aspects of life in the multicultural education.<sup>8</sup>

The change in multicultural education is not oriented on figure justification, statistic and cognitive *ansich* as the assessment of most of education is. It is more likely to know the comfort, tranquility, and tolerance that happens in society so there will be no more conflicts caused by the difference in culture, religion and racial.<sup>9</sup>

Furthermore, H.A.R. Tilaar states that multicultural education becomes one of the vital demands to build the new Indonesia. This education needs more studies to understand the concept and practice better and deeper.<sup>10</sup>

Mahfud, in his analysis of the urgency of multiculturalism education, says the concept of multicultural education has not been studied seriously until now. However, in

---

<sup>7</sup> *Ibid.*, page 5.

<sup>8</sup> Chaerul Mahfud, *Pendidikan Multikultural*, Yogyakarta: Pustaka Pelajar, 2013 hlm 74.

<sup>9</sup>Stephen Hill, Direktur Perwakilan Badan PBB Bidang Pendidikan, Ilmu Pengetahuan dan Budaya, UNESCO untuk kawasan Indonesia, Malaysia, Filipina, dan Timor Leste, dalam chaerul Mahfud, hlm. 200.

<sup>10</sup>Tillar dalam Chaerul Machfud , hlm. 211.



juridical way, the laws of National Education system year 2003 states that the chance to enlighten the people of Indonesia about the multicultural education concept, in article 4 verse 1 about the practical and principle of education implementation which considering the various society cultures values.<sup>11</sup>

Tilaar, also says that our educational system is not experienced enough in multicultural education itself. Hence, it needs to be studied in every aspects about what multicultural educational really is, about the philosophy of content an also the challenges in the implementation process. We should also learn from another countries' experience that have been applying the multicultural education on their pluralistic people in this globalization era.

Multicultural reality in society is an asset to expand the culture strength in a country. As an amazing asset in a country it cannot be obtained easily. Hence, it is clear that such asset is worth to be protected and conserved.<sup>12</sup>

## **5. Alternative Medium for Preventing Conflicts**

The multicultural idea implementation through education is believed as *preventive step*, the real solution for conflicts and dis-harmonization in society in reality with pluralistic matter. In other words, the implementation of this multicultural education can be found an observed in many collective lives as the alternative means in solving socio-culture conflicts.

Today, multicultural education contributes in two significant conditions, for preparing individual to be able to face the new culture in globalization era; and uniting the nation elements itself which consisting of many different cultures.<sup>13</sup> These two conditions involve in education help people to achieve the internal ability to involve to face the live in togetherness.

Indeed, multicultural education values is not given interconnectively with the right portion. Then, school as one of the educational institution can develop multicultural education based on school autonomy. According to the writer, multicultural education is implemented better by using *interconective approach* in religion education subject, by discussing the values in *the universality of Islam for togetherness*.

---

<sup>11</sup>Chaerul Mahfud, *Pendidikan multikultural*, ... 2013, hal 255.

<sup>12</sup> *Ibid*, hlm. 255.

<sup>13</sup> Chaerul Mahfud, *Pendidikan Multikultural.....* hlm 290.

Until now, the number of learners who understand what it is behind the culture in a country is less than we expected. According to Suyanto (2009), the society knows better about the stereotype of race compared to what that race has. In fact, discourse of multicultural education understands well about the meaning behind the culture reality from a race is very essential.

Hence, multicultural education is successful in implementation if a student or individual of a society lives in tolerance, peace, non-conflict with each other regardless the difference in culture, race, language, custom and/or tradition.

## **6. Preservation Regional Root Culture Early**

Mahfud says beside as alternative medium in preservation and problem solver, multicultural education also cultivates every student for stay still with their own root culture they have even when they are face with globalization era. The preservation efforts can be obtained by teaching behavioral matters early. That way, the internalizing of such behavior will be implemented starting from family environment.

Based on *Multicultural of Education* seminar, held by Universitas Negeri Jakarta (UNJ) Stephen Hilf, Fuad Hassan, Siswono Yudo Husodo, and HAR Tilaar as speakers, state that:<sup>14</sup>

Anticipative step is needed to anticipate the globalization challenges, particularly in cultural aspects. Because most students in Indonesia now is way different with children in the same age in past were. The cultures from another countries is adapted without filtering from various media, such television, and internet and much more. The advance in technology and knowledge shortens the distance and ease the interaction of cultures.<sup>15</sup>

In his analysis, Mahfud states that: the challenge in our educational system is very hard and complex.<sup>16</sup> Furthermore, anticipative effort should be designed thoroughly. If it is not perceived seriously with proper problem solver, by means the educational system is responsible for the human resource in this country, the children will be losing their way with the original culture of their own country has.

## **7. Rasa Aman sebagai Kebutuhan Hidup Masyarakat Multikultural**

---

<sup>14</sup>Chairul Mahfud, *Pendidikan Multikultural*, .... hlm. 271.

<sup>15</sup>Fuad Hasan dalam Haerul Mahfud, hal 281.

<sup>16</sup>Chairul Mahfud, *Pendidikan Multikultural*, ....284.

*Need*, as has been discussed by many experts in hierarchy figure, in multicultural context means that *need for security* is a vital matter as it has a very prominent function. Conflicts or local gang fight as has happened in many occasions is caused by the failure attempt of *security condition* in their environment. The background is very complex, but most of them do not respect and accept each other's difference in culture.

As seen in the fourth hierarchy is the need of safety conceptualized by Abraham H. Maslow.<sup>17</sup> He develops the individual motivation theory explaining about kinds of needs and based on the priority level. The individual hierarchy is shown as follows:

1. Actualization of the form-self.
2. Need for pride.
3. Need for ownership and love.
4. Need for safety.
5. Need for physiology interaction (*faali*).<sup>18</sup>

Generally, the hierarchy needs shows the fulfillment stages in life, meaning that individual needs starting from the family. In Trans Dalam, the residents have been staying for 20-30 years live in peace with their multicultural society. However, there should be field research of it to see if this finding can confirm the theory of *need of security* such as feeling of being freed of conflicts, and living in ease with conducive condition.

Maslow also said that individual need is the need of *self-actualization*, for someone to motivate achieving the potential-self.<sup>19</sup> For example, admitting for another's opinion, admitting the truth from other people and self's faulty, and also adapting well with any situation.

The achievement in education also contributes in changes in social status from mobility social theory perspective.<sup>20</sup> By immigrating a few number of Javanese-Banjarish and local Dayakish people to Trans Dalam as new residents with multicultural characteristics, the cultures they have can fuse easily, without many fractions with their original culture, not only accepted by their own people but also in socio-religious matter. Trans Dalam residence, not only grows the socio-religious phenomenon, motilities vertical intrageneration and intergeneration phenomena which can be observed easily. These phenomena, is interesting to be researched viewed from many aspects, whether

---

<sup>17</sup>Abraham H. Maslow, *Motivasi dan Kepribadian*, terj. Nurul Imam, cet. ke-4 (Bandung: Remaja Rosdakarya Offset, 1993), hlm. 43-57. Bandingkan dengan Matt Jarvis, *Teori-teori Psikologi*, terj. SPA-Teamwork (Bandung: Nusa Media, 2010), hlm. 94. Jarvis dua kebutuhan sosial, kebutuhan dihargai, kebutuhan intelektual, kebutuhan estetis, yang puncak adalah aktualisasi diri.

<sup>18</sup> *Ibid.*, hlm. 94.

<sup>19</sup> Matt Jarvis, *Teori-teori Psikologi*, hlm. 93-95.

<sup>20</sup> Anthony Giddens, *Sociology* (Cambridge: Polity Press, 1993), hlm. 249.

from the uniqueness of the rural area itself, the culture holders, the striving for knowledge ethos, trading ethos which way too far from the urban environment.

## **8. Interactions and Sosio-Religius**

Individual interaction happens in many space and time. It is unlimited, hence it is possible for Trans Dalam people for interacted every time, whether in sociology intraindividual pattern, social group interaction, between in the believers of particular religion individually or in a family context.

The interaction happens incidentally and intimately between different believers of religions in the community.

## **9. Data Collection and Data Analysis**

There are at least two communities in Trans Dalam. The location for its people is set by the government, managed by Dinas Kependudukan and Transmigration since it was started in 1987/1988. The area, house, and farm is based on government policy. The people got their own house by drawing to make it fair. The fairness principle is internalized since those people arrived to grow the peaceful, dependable, and content feelings between themselves.

The satisfying feelings of Trans Dalam people is relevant with the fusion effort to make sure the solidarity grows so it will be easier to make change in social, economic, and the understanding of the importance of togetherness.

....in 1997 we arrived here as elementary school teachers, it was when government sent us to transmigration area. It was isolate, then few years later the children were born, the residents numbers were growing. We were recruited as teacher right after we graduated from SPG 1 Palangka Raya. I did not have any chance to continue my study because I have three younger siblings, so we had to take turns to continue our studies. So I worked and tried to apply as elementary school. Open University was first here when there were only few students so we had to go to the county to have the exam. The lecturers are from afar so we had to pay fees for that. It is possible to join forces with other regencies so the exam can be held in Kapuas regency but it is not carried out well just yet...<sup>21</sup>

The farm was dull at first, some residents had difficulties for managing their farm. Some of them successfully make a living from their farm by the help from intensive cultivable local unit. While people from Java were eager to cultivate their farm, some from Banjarish or Kapuas found it was not easy for them to do farming. The experience and patience is needed, so they decided to start trading business. It was also not easy at

---

<sup>21</sup> *Ibid*

first, but as the time went by, it was getting better, admitted a resident originated from Kapuas as follows:

... Dayakish transmigrants are rarely working as farmers. They are reluctant to do so because of the acid level in the land and water was so high that it is hard to cultivate the farm. They earn money by selling crops, also coffee and coconuts. When it is nearly Idul Fitri like this, the price goes down, only Rp 13.000 per kilograms. It is hard to balance with the debits, we sell one and half kilo of coffee for one kilo of sugar. However, when the price goes up, we can get Rp 17.000 until Rp 20.000 so it is quite satisfying. Other than that we also sell local chicken, it is quite expensive when Idul Fitri comes...<sup>22</sup>

There are at least two different psychological characteristics reflected based on two interviews. First the residents who are interested to professional work as an employee of government, such as teacher, nurse rather than working as farmers. Second, the residents know the importance of sending their children to school, having a debt and also working incising rubber tree early in the morning.

Being compare to need theory of Maslow, Trans Dalam Village residents condition is relevant with the theory of the fulfillment for cognitive/knowledge achievement to get into another level of advancement in life, to prepare the children to be able to actualize his potential bringing their rural area's name and also family name. This phenomenon is explained by Jarwis, in which he expands the 5 theory of need to 7. It is the *need for cognitive* which related to educational institution or need for education before making onto the top of the *need for actualization*.

... It is very peaceful here. I have never witnessed any bothering actions around. The concord between different religion believers is very good. When Idul Fitri is around, there is no difference between Christians and Moslems. There are also no differences in treating other people base on their tribes, we only know the elders or *kadus* (village chief). We are united in RT 16, sometimes it is called market area. Most people here are Banjarish, only a few of them are Javanese...<sup>23</sup>

....we like helping each other when they are busy. For example, at this time Idul Fitri is soon, I am as a Christian helping them to prepare for the feast, and when Christmas is around, they will help us back. It is like a routine happening during those time. Men, women, children will visit their houses on those days. The women usually help making snacks and desserts. There is no problem or constraint in living together with many neighbors...<sup>24</sup>

Sociologically, these habits of helping each other appears as the result of interaction in believing and respecting each other. Visiting each other on Idul Fitri or Christmas is also meaningful for both sides, as long as they do not involve in the ritual worship. Because for Moslem, it is clear that in aqidah and worshipping that *Nor will ye*

---

<sup>22</sup> *Ibid*

<sup>23</sup> *Ibid.*

<sup>24</sup> *Ibid.*

*worship that which I worship*, which means both of them must be separated, it is not meant to be interconnected or integrated.

In society aspect, the basic need fulfillment, as called by Maslow as *physical need*, the Trans Dalam communities fulfilling them by doing interconnected interactions. A resident with abundant harvest will share some of it to neighbors or colleagues whose not lucky enough hence no resident is too poor even for eating. As stated by a resident as follows:

...we live in a very humble way, we do not wish for anything fancy in life. However Thank God we are not that poor. We are able to earn money to buy foods as long as we work. It is very peaceful here. There are three tribes living here, Banjarish, Javanese and Dayakish. I have been living here long enough but I have never witnessed any conflicts or frictions because the difference in religion. The melees happen mostly because of the delinquency actions from our elementary student over petty things. However sometimes there are some issues going around which terrify us, but in the end it usually ends as issues....<sup>25</sup>

The productivity skills is developing as well. The residents are smart enough not to make everything complicated. They admit that they live in peace regardless they are Moslems or Christians, Javanese, Dayakish, or Banjarish. This has been implemented in Trans Dalam residents way before many transmigrants come and fuse with the local transmigrants.

...they planted these things they get from the rice field, they planted them to mat or hat. It is their mean of living, they sell them while also sell coffee seeds. They also sold their house and farm. Most of Banjarish people is no longer living here. Only some Javanese people stay in RT 16...<sup>26</sup>

It was admitted by some Banjarish and Dayakish people, that the achievements in education is fulfilled. Another aspect is the ethos in working an education itself. It was admired by the residents of Trans Dalam. Here is a snippet from an interview from a resident:

...Javanese people education level is higher than it was in the past. They send their children to university and college. Most of them were only graduate from elementary or junior high school. However now, their children are mostly bachelors. So it is indeed getting better. For those who do not go to university usually start working in oil palm factory, it is good money so it seems like they enjoy working there...<sup>27</sup>.

They also respect the leader and hard-working people to get higher education level. They also refuse to defend someone's faulty. Psychologically, they are used to live with responsibility of their own actions...

---

<sup>25</sup> *Ibid*

<sup>26</sup> Wawancara dengan Normansyah, 11 Agustus 2013.

<sup>27</sup> *Ibid*.

## 10. Implementation of Interconnective Ideas with Sosio-religious values in Trans Dalam Society

The implementation of multiculturalism ideas do not happen instantly, apart from connected other ideas, for example the implementation grows together with the understanding of the religion, and hence it grows intrinsically. The residents are fit, relieved, assisted, and happy being in the same domicile **with migrant worker (perantau)**. **Migrant workers** are different in their backgrounds, tribe, and religion. However in their daily basis they interact peacefully with the local residents. They respect, help, and admit that living together in peace is very important, as assumed from this snippet of this interview:

...we live peacefully here, we respect and help each other. It is all good. For example, Mrs. Intan's husband is Banjarish. We do not differentiate him just because he is different. We are not bothered by the fact we're living in diversities... In the elementary school here also there is another example, Mrs. Ainun is Banjarish as well, we have been interacting for decades, and she is kind and warm hearted. The headmaster is Javanese, Mr. Tohari is like a family... Yeah, we know each other well and he is a close friend in teaching in the elementary school...<sup>28</sup>

It seems like the bond as the result of the interaction of these three tribes Dayak Kapuas (the local residents) and another transmigrants (Banjarish and Javanese) is quite strong. The bond is focused on the psychological agreement that grows positively. The three tribes (Dayakish, Banjarish, and Javanese) would rather manage and think about their own family internal matters, than meddle the neighbors' business. In another statement, they have quite self-restrain to manage their own will, without forcing and intervening the local residents and another transmigrants about any new ideas.

## 11. Marriage as a Proof of Reforming of Social Religious Interconnection

Compatibility between man and woman from different hometown background increases. Wahyu and Sriwahyuni involve their self in community and finally get married.

... I am married to a transmigrant. Mr. Wahyu is a transmigrant from Java, Bojonegoro. He went here to work in Unit Pemukiman Transmigrasi (UPT). I have my school degree, and joined transmigration program in 1982, I was in Kuala Kapuas which now has become definitive village, in Basarang as now is a

---

28 Wawancara dengan Bu Sri Wahyuni, 50 tahun, di ruang tamu rumahnya, didampingi pak Wahyu, suami yang semula muslim. Dua anak laki-lakinya sudah bekerja di Dinas Pekerjaan Umum, Provinsi, keduanya lulusan Strata 1 Fakultas Teknik dari sebuah Universitas di kota Palangka Raya.

district capital. Now the transmigration employee can choose if they want to work at the district office or any institution....<sup>29</sup>

The marriages in Trans Dalam sociologically becomes a strong will of living together between two people, and it now appears as one of the social institution construction as well as connection with social religious interaction. It can be seen from the success of her two sons who finished their university degree in a university in Palangka Raya.

Mr. Wahyu's family never finished his university degree, yet the sons obtain theirs, so it is what makes him and his wife happy. Their sons re now working full time jobs with big salary so they can help their mother. Mr. Wahyu and Mrs. Sri are thankful because of the marriage of two different culture backgrounds can make as themselves right now. The sons are also living in town which can be reached easily. Mrs. Sri also explains that the marriage that happens between two different cultures will produce children who are smart, strong willed, and devote to their parents. According to the author, this case is worthresearching. This marriage couple are happy to be living together with the transmigrants, as said here:

... I was married in 1982, I am a Dayakish from Kapuas, and we were assigned here in 1982, if I am not mistaken, yes, in 1982. We never move because I always feel like at home living here. I am working as a teacher of elementary school. As my husband, he works in many different areas, and I am staying here all along. He worked in Dadahup, Sebagau, and also Belawan. I have ever moved to Belawan for three years, but then I came back here. My husband is the deputy here in UPT Pangkoh<sup>30</sup>

From the interview, it can be concluded that the wife does not like living in many different locations. It is understandable because the new location for teaching is more remote than the village she was currently living.

Trans Dalam village is a conducive location for Mrs. Sri and Mr. Wahyu because they have already known the people, they are quite close, the workplaces are near, and the farm's pleasing results. Psychologically, particularly motivation psychological as stated by Maslow and Abin Syamsudin Makmun from Universitas Islam Nusantara Bandung, this behavior indicates the growth of extrinsic motivation with the individual *needs* to family, neighbors, and friends' closeness. The peacefulness and closeness grow and develop as conclude from this interview:

....it is safe here, we never had any conflicts. When Idul Fitri comes like this, we visit each other. I am Christian, but we also celebrate it together, the more the merrier. There are only about 4-6 Christian families here, 98% of the total residents are Moslems in Kantan Dalam...<sup>31</sup>

---

<sup>29</sup> *Ibid.*,

<sup>30</sup> Wawancara dengan Bu Sri, 50 tahn di ruang tamu rumahnya. ....

<sup>31</sup> Wawancara dengan Bu Sri, 11 Agustus 2013.



Sociologically, this visiting habit in religious celebrations is one of many interaction ways, consciously or unconsciously. The visits on particular occasion and moments are better than doing that just because job reason or personal reason.

In between believers' context, there is horizontal connection from human to human or *silaturrahmim* (in Islam terminology). There are few communities in Trans Dalam, and this religious communities are led by some prominent figures. Social communities are also found, such as Paguyuban Dulangmas, Paguyuban Paku Wojo (both are for Javanese people) and Paguyuban Dayak Bakumpai. These communities are sociologically may cause conflicts in the future, as well as a place for creating harmony in difference. Among the people have no specific skills and Banjarese residents living near Pasar Rebo (Rebo market) acquire working skills. These skills bring benefits for society.<sup>32</sup>

A residents states his happiness by living together with another transmigrants, as said here

... Banjarish are probably only 17 families here, from Hulu Sungai Selatan Regency, it is less than 2% of the total residents here. However in Pandih Batu is *fifty-fifty*, yes, in the district capital, in transmigrants are almost 99% Moslems. They live in unity and respect each other. Moreover if they are also Banjarish, and they have same religion as we do, it feels like a family.....<sup>33</sup>

Ethnically, even though they are from many different tribes, the habits, customs, and traditions can be changed as the time goes by, the immigrants adapt the habits easily, and they know their place and try to follow the rules. This attitude is very accolade in Islam, because this person is useful for other people. The best human kind is who is useful for another.

Banjarish people are known for their skills in trading, and doing transaction. Geographically, they would rather live around business area than in farming area. They most likely live in area near the mosque, schools, boarding schools, and another Islamic institutions. They pay more attention to the education. They concern about Islamic studies and values. The local leaders of village, market as well as religious ones admits the importance of search of knowledge and pursuit of happiness in the world and hereafter.

This ability for taking the priority for doing good deeds for the hereafter life is relevant with the forming of insan kaafah, insan kamil. Being a trader around pasar Rabu in Trans Dalam is for helping their economic condition. The religious

---

<sup>32</sup>Anthony Giddens, 1999 *Sociology*: Cambridge: Polity Press.Hlm. 88.

<sup>33</sup>Wawancara dengan Normansyah di ruang Tamu rumahnya, di seberang pasar Rebo, 11 Agustus 2013.

motivation is to be able to go to Mecca for Hajj with their own effort, without any help from the government or institution. From psychological aspect, they have high *self-confidence* to reach Allah SWT's bless in short time.

....there are a lot of Javanese, Dayakish, and Banjarish people here... I am Banjarish, and I have two sons, and they have their own families, I also have a grandchild. My daughter in law is Javanese and now living in Sampit....<sup>34</sup>

The marriages between Javanese and another tribe have been changed. The change is discarding the Javanese philosophy. They no longer use the birth day or month to a consideration factor in marriage. The marriage in Mr. Wahyu families happens naturally. Even though they are from different ethnic, they are blessed by both families and finally married in a wedlock. The attraction based on the same belief and education. As in Islam, what Mr. Normansyah's son does is relevant with what hadis recommends, by marrying an interesting woman. His son marries his girlfriend because of her sex appeal and intensive interaction during their study in college.

The marriage story between Mr. Wahyu and Mrs. Sri is a bit different, Mr. Wahyu did *conversion in religious faith* in 1987. Wahyu is from Java and his wife is from Kuala Kapuas. Both of them met in the workplace, and then married because of love with steady family foundation. Both of them have a stable job therefor makes the family ale to produce internal and external quality in life. **Internally, the family possesses nice shaped home with green fresh lawn of varied fruits like rambutan, mangos. A nest of honey bee exist near the house.**

Externally, this family has stale economy condition. The have rubber tree farm, cattle, and renting car so they can pay for their sons' tuition in university. Here is an excerpt of an interview:

.... I was just helping in transmigration office here, I have been working since 1980 and knowing 17 villages so far. In 1980 I was offered to become government employee, but I declined. Yet in 1981 I was offered once again to work in Kalimantan, in transmigration section. The honorary job need at least 5 months to become a full time employee, and the salary at that time was bout Rp 27.000 per month... <sup>35</sup>

Wahyu was not motivate to become government employee in Transmigration office, because the salary was not high enough. Yet, the honorarium salary as a staff in

---

<sup>34</sup>Interview with Normansyah, 11 Agustus 2013.

<sup>35</sup> Interview with Wahyu, the husband of Sri , 11 Agustus 2013.

UPT was way bigger. The honorary status at his workplace is near with his home while being a government employee means he is willing to move to any places.

Mrs. Sri, Mr. Wahyu are Banjarish who live di Trans Dalam. They like being together and form a community around pasar Rebo. The house and the farm were sold, and they decided to buy a house near the market. Therefore, small residence in pasar Rebo, RT 1, is formed as stated here:

...the Banjarish are quite a lot here around the market, pasar Rebo. In another place are rare. We are mostly traders and as transmigrants as well. Our houses and farms were sold. Even though we have some lands, it is usually rubber tree and palm oil tree with paying Javanese people to manage them.<sup>36</sup>

The background of the lands influence the lifestyles of its people. Banjarese locals insist to follow childhood experience they have been through. Normansyah from Ajir Pasar, come along to join transmigration program with his fellow merchants.

Norman and his friends sold their houses near the farms and then built their houses near Pasar Rebo. They have experience in trading so they starting their own business, and as the results it is quite good for earning money even though the market is merely a weekly activity. However he does trading every day.

Another Banjarish people in di Trans Dalam. They are very good in fishing and have many experience. Their skills are admired by the Dayakish and Javanese, as stated here:

... Banjarish likes trading and some of them also very good in catching fish, when dry season comes, they will have a lot of money after selling the fish...<sup>37</sup>

This social religious behavior happens when someone is passed away, they will visit them and send them to the graveyard together. Non-Moslem residents are also coming and help as well as stated in this excerpt:

.. Pak Ronta is from Kapuas, he is Dayakish and works in clinic, if a Moslem passed away, he would visit and send condolences. He stayed in provided house. We would do the same thing if one of his family passed away. There would be no conflict and political gap among residents. They respect each other. If somebody die all community from different background will accompany him to the grave. All moslem, Christian, daakese, banjarese, are living in harmony which would not happen in any place like this. There are some Christians belong to this society, Pak Ponidi from Java, Pak Jenggot residing across the street. They are both very kind to neighbors.<sup>38</sup>

---

<sup>36</sup> Interview with Norman, 53 years old.

<sup>37</sup> Wawancara dan pengamatan.

<sup>38</sup> Wawancara dengan Norman di rumahnya, 11 Agustus 2013.

## 12. Conclusion

Trans Dalam residents are highly motivated to preserve the ideas of multicultural. The process appear intrinsically, starting from the understanding of religion theory for doing good deeds in life. The residents apprehend the means of cooperation that is working together as one, help each other in useful things in life.

They have the spirit and persistence to face the geographical challenges such as the distance with urban area, the weather, land's prosperity, the water acidity level. However they have strong will for fulfilling the *need for achievement*. It is indicated from the spirit in working together, respects, appreciation towards each other, and visiting each other in celebrating religion days reflected the solidarity. It grows steadily to achieve comfortable environment for each other in social external ways, even though it is different indeed. This is the reason they live in peace and harmony.

They are able to overcome many problems to make themselves strong, confident, and able to confront greater problems in life. They have good conception of knowledge, confidence yet do not hesitate to give support, and responsibility so that the peaceful life can be created easily.

The proof of the success of modern mobilization is relevant with vertical social mobility theory. The facts shows that the residents are successful in doing the vertical mobility intrageneration and vertical intergeneration. The implementation of multiculturalism ideas happens in harmony. During their celebration of holy days, they seem to pay less attention on religious differences. This phenomena become particular channels for socio-religious and local economic system.

The growth of multicultural ideas is caused by few things, which can be analyzed sociologically and psychologically. The socio-religious interconnection is influenced by external factors. They are motivated by the surroundings to live in peaceful and safe places that it also support the achievement in working. Intrinsically, Trans Dalam residents are creative to have a new opportunity to make a living, hardworking, and thrifty in spending money. They consider other residents as families.

Sociologically, the village elders and leaders supports the strong will of the residents to live in peace. The social system supports is given so that there is no different treatments for those who live there. Any misconduct actions will be judged fairly. This social system, such as cohesiveness, solidarity, concord, harmony, and *silaturrahim* are preserve together as unity. Beside social system and family system factors, it cannot be denied that the government role with development programs is

essential to the residence itself, as well the peace and order section monitored by the Sector Command and Koramil Pandih Batu area.

## **REFERENCES**

- Abdullah aly, Pendidikan Islam Multikultural di Pesantren, Pustaka Pelajar: 2011. Yogyakarta.
- Conny Semiawan, The Class Large of a Multi, Edin a Pluralistic Sosiology: the Indonesian Cate. Jurnal Antropologi Indonesia. 2004.
- Chaerul Mahfud, Pendidikan Multikultural, `Yogya: ustaka Pelajar, 2013
- Kamanto Sunarto, Multi Ed in Schools: Chanllenges in, It Implementation
- Mulkhan, Abdul Munir, 2004. Pendidikan Monokultural Vs Multikultural dalam Politik.
- Tilaar, H.A.R 2002. Perubahan Sosial dan Pendidikan: Pedagogik Transformart untuk Indonesia, (Jakarta: Grasindo).
- Syahid, Achmad dan Zainudin Daunlay (eds) Rihuh di beranda Satu: Peta Kerukunan
- Sulalah, Pendidikan Multikultural: Didaktika Nilai-Nilai Universitas Kebangsaan, Malang: UIN Maliki Press. 2012.
- Umat Beragama di Indonesia. 2001. Jakarta: Pusat Litbang Keluhuran Beragama RI.
- Whid, Abdul 2001, Pengulangan Negara, Agama, dan Kebudayaan, (Depok: Desantara).

**Topic : Law**

**LEGAL DEVELOPMENTS OF FIDUCIARY IN INDONESIA :  
A SPECIAL REFERENCE TO INTANGIBLE MOVING SECURITY  
OBJECTS**

Achmad Busro<sup>a</sup>, Yuli Prasetyo Adhi<sup>a</sup>, Dewi Sulistianingsih<sup>b</sup>, and Indah Susilowati<sup>c</sup>  
<sup>a</sup>Faculty of Law, Diponegoro University (UNDIP). Jl. Prof. Soedarto, S.H. Semarang 50275,  
Indonesia.

<sup>b</sup>Faculty of Law, Universitas Negeri Semarang. Kampus Sekaran Gunungpati  
Semarang, 50229, Indonesia

<sup>c</sup>Faculty of Economics and Business, Diponegoro University (UNDIP).  
Jl. Prof. Soedarto, S.H. Semarang 50275, Indonesia.

Corresponding author's email: [indah-susilowati@rocketmail.com](mailto:indah-susilowati@rocketmail.com)

---

**Abstract**

Fiduciary is a transfer of ownerships of goods on the trust basis using the transfer mechanism of property rights on the goods belonging to the debtor to the creditor, although the goods remains in the debtor's possession. The legal development of fiduciary in Indonesia experiences a significant growth, particularly in the objects fiduciary in the security of moving intangible objects. The existence of legislation has influenced the development of fiduciary law in Indonesia (Act No. 28 of 2014 on Copyrights). The copyrights Act governs the fiduciary security object as an intangible object secured using fiduciary.

This study aims to formulate the development of intangible moving security objects as fiduciary security objects in Indonesia. This paper is intend to analyze the occurrence of fiduciary using intangible moving security objects. The research question raised is how is the execution of intangible collateral objects in fiduciary. Furthermore, this research proposes a strategy for executions towards fiduciary security objects in the form of intangible moving objects.

**Keywords**

Keywords: Fiduciary; Security-Objects; Intangible; Moving-Objects; Indonesia

---

**Introduction**

Insurance agencies in Indonesia are the ones that bring debtors and creditors together for the purpose of granting or obtaining loans or account payables. The existence of the agency is definitely necessary for the development of trade and investment in Indonesia. The investment and trade require funds and they can be obtained through bank credits. Banks, in order to grant a credit, require the debtors to provide collaterals to guarantee repayment of the debt. It serves as a precaution against the possibilities of risks in repayment of the credit/ loan. A collateral is something given

to the creditor(s) to induce trust that the debtor will fulfill his obligations and can be valued in money.

One of the security institutions in Indonesia is a fiduciary institution. The word fiduciary, which originally comes from a word "fides", means trust<sup>1</sup>. Therefore, under these circumstances, the legal relationship between the debtor(s) (the provider of fiduciary) and the creditor (the beneficiary of a fiduciary) is a relationship which is based on trust. The principle underlying the relationship of both parties is the principle of trust. The fiduciary provider believes that the beneficiary will restore the property rights over the goods which have been delivered, after having paid his debt. Similarly, the beneficiary of a fiduciary believes that the provider will not abuse the collateral that is in his possession.

A fiduciary is an ownership transfer of goods on the basis of trust using a delivery mechanism of property rights on goods belonging to the debtor to the creditor, while the goods remain in the debtor's possession. A fiduciary is security rights over movable goods either tangible or intangible and immovable goods, like a building which cannot be encumbered with a mortgage, which remain in the control of the fiduciary provider, as collateral for the repayment of certain debt, which make the beneficiary more preferable than other creditors.

Fiduciary objects are regulated in Article 1 paragraph 2 and 4, Article 2 and Article 3 of Fiduciary Act (UUJF). Article 2 says that the Act is applicable to any treaty which aims to encumber a good with fiduciary and subsequently confirmed by Article 3 which states that the Act is not applicable to: 1) a mortgage related to land and buildings, so long as the laws and regulations applied deciding on such objects shall be registered; 2) mortgages on vessels registered with a gross tonnage of the size of 20 (twenty) m<sup>3</sup> or more; 3) mortgages on the aircraft and 4) pawning. Fiduciary objects mentioned in the article 1 paragraph 2 are moving objects, either tangible or intangible, and immovable ones particularly a building which can not be encumbered with a mortgage. In addition, the article 1 number 4 defines the objects as everything that can be owned and transferred, either tangible or intangible, registered or unregistered, movable or immovable which can not be encumbered with a mortgage. In the nutshell, a fiduciary object is an object that its ownership can be owned and transferred, whether it is tangible or intangible, registered or unregistered, movable or immovable which can not be encumbered with mortgages.

The decree of the Ministry of Justice and Human Rights, Directorate General of Administrative Law to the Regional Office of the Ministry of Justice and Human Rights Jakarta No. C. HT. 06-10-01 dated on February 24, 2010 states that: (1) the rights of the fiduciary object is material in nature; (2) project terms, rent, contract or leasing, as well as other individual rights cannot be defined as the objects being used as the object of fiduciary; (3) an insurance policy can not be used as an object of fiduciary insurance for it is inherent to an individual who owns it and it can not be transferred.

Fiduciary objects especially on the intangibles experience a significant growth. Act No. 28 in 2014 on Copyrights has set the development of intangible objects which can be insured using the fiduciary. Copyrights act also governs copyrights as objects of fiduciary. An artist can use his work as a fiduciary to obtain loans from banks. It is stated

<sup>1</sup> Gunawan Widjaya and Ahmad Yani, *Jaminan Fidusia*, Raja Grafindo Persada, Jakarta, 2005, p.115.

in Article 16 clause (3) which reads, "copyright can be used as objects of fiduciary," This article does not necessarily make banks easily give loans. The settings in Article 16 paragraph (3) does require a further elaboration. It is associated with a guarantee for the bank to get a payment certainty of the loan from the artist. The payment certainty from a loan guaranteed using the copyright is due to whether the songs are salable or not. In general, banks are willing to give a loan to the recipient as long as he can provide something from his possession to ensure the continuity of the debt payment.

The use of copyrighted work as a fiduciary in Indonesia is just recently possible since the enactment of Act No. 28 in 2014. Therefore, its provision order is still from being complete. The problem which occurs in Indonesia is that the provision on the use of copyright as collateral in bank lending system is not fully available, as well as the unavailability of assessment institution having the ability to assess the economic value of the copyright. In some countries like the United States, an insurance of intangible goods such as copyright is already set. Software developers can get help from a financial institution. The settings in article 16 (3) related to and even dependent on other acts, as mentioned in the article 16 paragraph (4) that the "The provisions on copyright as an object of fiduciary referred to in paragraph (3) shall be implemented in accordance with the legal provisions". The closest legal provision is Act No. 42 in 1999 on Fiduciary.

A copyright can be encumbered as a collateral in the form of fiduciary as set forth in UUJF, not on the objects encumbered by the copyright itself, but more on the economic value inherent in the copyright<sup>2</sup>. For the next development, we need to observe further by conducting research to find out the development of the intangible insurance object that can be pledged fiducially. Fiduciary objects which develop due to the new provisions in the Act will result in other provisions of the fiduciary that are related to the manufacturing process of the fiduciary insured using intangible objects. It is possible that, just like a copyright that becomes an object of fiduciary, other rights in intellectual property such as trademarks, patents, industrial design rights, etc to be used as fiduciary objects. It is interesting to examine the extent to which intangible objects can be encumbered fiducially, such as securities-stocks, bonds, drafts, money order deposits, etc. This research is important considering that previously the object used as collaterals in a fiduciary was a moving object but in its development disembodied movable objects or immovable property which can not be encumbered with mortgage can also be used.

### **A Share as a Fiduciary Object**

Property right is an absolute power given to an entity by the law to directly control an object regardless the whereabouts of the object itself<sup>3</sup>. Gunawan Widjaja defines an object as anything or any right that can be governed by the property right, or in other words anything or any right that can be owned<sup>4</sup>. In addition, Sri Soedewi Masjchoen, defines an object as: "... similarly, an object is firstly any tangible good that can be perceived by the senses, but intangible items can be included as an object as well. In short, juridically, an object is defined as anything that can become a property object of

<sup>2</sup> See, Sudjana, *Hak Cipta Sebagai Jaminan Kebendaan Bergerak Dikaitkan Dengan Pengembangan Obyek Fidusia*, Jurnal Mimar Hukum, Volume 24, Nomor 3, Oktober 2012, p. 416.

<sup>3</sup> CST.Kansil and Christine S.T Kansil, *Modul Hukum Perdata; Termasuk asas-asas Hukum perdata*, Pradnya Paramita, Jakarta, 2004, p. 161.

<sup>4</sup> Gunawan Widjaja, *Seri Hukum Bisnis : Memahami Prinsip Keterbukaan dalam Hukum Perdata*, PT. Rajagrafindo persada, Jakarta, 2006, p. 16.



article 499 of the Civil Code"<sup>5</sup>. In the Civil Code, the word "zaak" is not only applied to tangible goods, like article 580 of the Civil Code determines that some of the rights mentioned in the article as "immovable objects". Article 511 of the Civil Code also mentions some rights, interest money, payables and billing as moving objects<sup>6</sup>. So, in the legal system of the Civil Code the word "zaak" bears two meanings. First, it denotes tangible goods. Secondly, it denotes a part of assets. In the latter definition (i.e. as a part of assets) what can be included as "zaak" are any goods other than the tangible ones, some specific rights which are included as tangible goods, as well as some specific rights as intangible goods. According to the western civil law system as stipulated in the Civil Code, objects can be distinguished in tangible goods (lichamelijk) and intangible goods (onlichamelijk), movable goods and real estate, goods that can be used up (verbruikbaar) and goods that cannot be used up (onverbruikbaar), readily available goods (tegenwoordige zaken) and goods that will still be available in the future (toekomstige).

The immovable goods can be classified into: (1) characteristic-based immovable goods; land and everything on its surface, for example trees, small plants. (2) purpose-based immovable goods, for example machines used in a manufactory. (3) legal-based immovable goods. This can be in the forms of rights on the immovable goods, like the usufruct of the goods, mortgage, and so on. The movable goods can be classified into:<sup>7</sup> (1) characteristic-based movable goods, article 509 of civil code defines it as any transportable goods, like tables, or goods which can move by themselves like livestock. (2) movable goods based on law provision in article 511 of civil code are rights of usufruct of the goods, utilizing right, shares of the NV and so on.

It can be concluded that a share is included as a movable good as governed by the statutory provision namely article 511 of civil code. From the above classification, a share can be categorized as a movable good. Aside from the code, act number 40 in 2007 about Limited Liability Company, categorizes a share as a movable good and gives the holder rights over it. This classification results to limiting security institution to accept only movable goods as the collateral. When a share is used as a collateral, there will be a property insurance because the share is used as a collateral pledge and a fiduciary.

Article 60 paragraph (1) states "A share is a movable good and grants the holder rights as mentioned in article 52". There are holder's rights inherent in a share as set forth in the article 52 of Act number 40 in 2007 as follows: (a) attending and voting in shareholder meetings; (b) receiving dividend payments and remaining asset liquidation proceeds; (c) executing other rights under the Acts.

Those rights are applicable after the shares are recorded in the register of shareholders on behalf of the owner. Provisions in letters a and c do not apply to a particular class of shares as defined in the Acts of Limited Liability. Each share grants its owner an undividable right. In the case of 1 (one) share held by more than 1 (one) person, the rights arising from these shares are used by pointing 1 (one) as the joint representative.

<sup>5</sup> Sri Soedewi Masjchoen Sofwan II, *Hukum Perdata; Hukum Benda, Liberty, Yogyakarta*, 1981, p. 13.

<sup>6</sup> Ibid, p. 14.

<sup>7</sup> Ibid, p.21.

Article 60 paragraph (2), mentions that "Shares may be collateralized by liens or fiduciary to the extent not otherwise provided in the articles of association". These provisions provide two options for security institutions, namely: (1) liens; (2) fiduciary.

Under Act number 42 in 1999 on fiduciary, the assignment of the movable objects is recently not only by liens but also by a fiduciary. For immovable in the form of land right with security rights as stipulated in Act number 4 in 1996, can also be with a fiduciary for immovable objects which can not be encumbered with a mortgage.

The provision of 1150 of the Civil Code states that there are two parties involved in the mortgage agreement which are that the pledgor (debtor) and the recipient (the holder) of the pledge (the creditor). In article 1150 of the Civil Code, it is also known that the mortgage agreement is an accessory agreement, which serves as an additional agreement to the primary agreement, that is a loan agreement. The purpose of this agreement is to prevent the borrower from being negligent to repay the loan money or interest.<sup>8</sup>

If a share is not at the mercy of the insured, then it will be secured in a fiduciary institution. In Article 1 paragraph 1 of Fiduciary Acts, a fiduciary is defined as the transfer of ownership of a good on the basis of trust with the provision that the good whose ownership right is transferred remains in the control of the owner. Article 1 paragraph 2 mentions that a fiduciary is an insurance right over movable goods both tangible and intangible and immovable goods particularly a building can not be encumbered with a mortgage as stipulated in Act No. 4 in 1996 on Mortgage which remains in the Fiduciary provider's possession, as a collateral for the repayment of a certain debt, which gives priority position to the Fiduciary Beneficiary against other creditors.

The provisions of Article 60 paragraph (2) of Act No. 40 in 2007 states "Shares may be collateralized by liens or a fiduciary to the extent not otherwise provided in the articles of association". The provision explains that beside a share may be encumbered with liens or a fiduciary, it also explains that this imposition of liens and fiduciary may not be able to be implemented, if there are provisions the articles of association of a company prohibiting the shares in the company to be encumbered with liens or fiduciary.

The next provision, in Article 60 paragraph (3) states that the share mortgage or fiduciary that have been registered in accordance with the provisions of the legislation shall be recorded in the register of shareholders and special register as referred to in Article 50. Article 50 explains that the Board of Directors the Company shall hold and maintain a register of shareholders, which includes at least: (1) the name and address of shareholders; (2) the amount, number, date of share acquisition owned by the holder, and its classification in terms of issued more than one class of shares; (3) the amount paid on each share; (4) the name and address of the person or legal entity who has a lien on the shares or the recipient of the shares and fiduciary lien acquisition date or the date of registration of the fiduciary; (5) a description of depositing shares in other forms as referred to in the Article 34 paragraph (2). The record aims to provide legal certainty for both the fiduciary holders and the shareholders. The other shareholders, and all parties

---

<sup>8</sup> Djaja S Meliala, *Hukum Perdata Dalam Perspektif BW*, Nuansa Aulia, Bandung, 2012, p. 127.

involved in the company know that the shares in the name of the holder are being encumbered with the fiduciary.

Article 60 paragraph (4) states that the voting rights on the shares encumbered with liens or fiduciary remain on the shareholders. This reaffirms the principle of law that does not allow the transfer of rights regardless of the ownership of shares. whereas other rights outside the voting rights such as the right to the dividend may be contracted in accordance with the agreement between the holder of the mortgage.

### **A Copyright as the Object of Fiduciary**

The development of insurance law in Indonesia, especially on moving intangible objects, is applicable to copyrights. A copyright can be used as loan collateral because it has an economic value and can be transferred in whole or in part due to inheritance, grants, wills, a written agreement or any other cause justified by the legislation. The suitable type of insurance to copyright is a fiduciary for the transfer of objects as the object of fiduciary is done on the basis of trust in which the objects remain in the possession of the debtor. A copyright also meets the requirements defined in Article 1 (2) Acts on Fiduciary Insurance.

Initially, the Copyright Act did not regulate copyrights as a collateral object. Due to the issuance of the latest legislation on copyright i.e. Act No. 28 in 2014 on Copyrights in Article 16, paragraph 3 expressly states that a copyright can become an object of fiduciary. In the Act, it is also mentioned that in practice a copyright can be an object of fiduciary by following the procedures set up by the Law Fiduciary. In this case copyright has an economic value, but because it is an intangible good, it is difficult to determine its economic value, unlike chattels, for example cars, land or jewelry.

A copyright can be used as one of fiduciary objects since it has an exclusive right owned by its holder/ creator which is called economic rights. If a piece of work has an economic right, it has an economic value. The economic value obtained by the author or copyright holder can be in the form of the economic use of his creation. The instances of economic use are obtaining a reward for the use of his creation or earning royalties in the event of a contract/ license agreement. Therefore, parties entitled to ensure a copyright is the creator or copyright holder.

The regulations in the Article 16 paragraph (3) are related to and even dependent on other acts, as stated in Article 16 paragraph (4) that the "*Provisions on copyright as an object of fiduciary referred to in paragraph (3) shall be implemented in accordance with the legislation provisions.*" The closest legislation provision is Act No. 42 in 1999 on Fiduciary.

Article 1 point 2 of Fiduciary Acts says: "A fiduciary is security rights over movable goods either tangible or intangible and immovable particular building cannot be encumbered with mortgage rights as stipulated in Act No. 4 in 1996 on the Mortgage right that remains in the possession of the Fiduciary provider, as a collateral for the repayment of certain debt, which gives priority position to the Fiduciary Beneficiary against other creditors." A copyright has already met the requirements defined in the Article 1 point 2.

Article 1 point 2 of Fiduciary Acts says: "A fiduciary is security rights over movable goods either tangible or intangible and immovable particular building cannot be encumbered with mortgage rights as stipulated in Act No. 4 in 1996 on the Mortgage

right that remains in the possession of the Fiduciary provider, as a collateral for the repayment of certain debt, which gives priority position to the Fiduciary Beneficiary against other creditors." A copyright has already met the requirements defined in the Article 1 point 2.

A copyright as a fiduciary object in Indonesia is relatively new after the enactment of Act No. 28 in 2014. Therefore, the order of its setting is still incomplete. Problems faced in Indonesia are the absence of provisions regarding the use of copyright as a collateral in bank lending system and the unavailability of the assessment institutions that have the ability to provide an assessment of the economic value of the copyright.

Banks in Indonesia have not recognized a copyright as a collateral for loans due to several obstacles in its implementation. The obstacles are related to problems of the values, market, ownership and copyright filing authority as an insurance object. These obstacles rise because there are no regulations specifically stipulating a copyright to be a insurance object. These circumstances pose a considerable risk for the banks when receiving a copyright as an insurance object.

Banks in Indonesia have not recognized intellectual property, especially a copyright as a loan collateral using fiduciary method because there are several obstacles in its implementation. The obstacles are related to problems of the values, market, ownership and copyright filing authority as an insurance object. These obstacles rise due to primary problems regarding the absence of regulations specifically stipulating a intellectual property right especially a copyright to be a insurance object. These circumstances pose a considerable risk for the banks when receiving a copyright as an insurance object.

A copyright as an intangible movable has an economic value and is transferable, by a sale and purchase agreement. A copyright can be used as a fiduciary due to its inherent economic value, as stipulated in Article 16 paragraph (3) of Copyrights Acts that a copyright can be used as an object of fiduciary. The problem is that a copyright as a fiduciary certainly cannot be confiscated because its holder is adhered to it. This implies that law actually has protected a person's ownership as a copyright holder. However, in the terms of the contract itself, the debtor shall submit an object of fiduciary within the framework of the execution of the fiduciary because, in general, creditors are willing to give a loan to the debtor provided that he can provide wealth to ensure the continuity of his debt. A collateral is important not to be owned by the creditors, but if later the debtor breaches the contract and cause a bad debt, the insurance goods can be auctioned and the proceeds will be used as the debt repayment.

The recent development in the insurance law particularly on moving intangible objects like copyright is its recognition as a fiduciary object. This leads to a great opportunity to fiduciary development. However, the provisions on copyright as a fiduciary object are not perfect and thus it is necessary to set up implementation regulations governing the use of a copyright as a fiduciary object in Indonesia. This regulation will be enforced as a strong legal basis for the use of a copyright as a collateral.

### **Conclusions**

Act No. 40 in 2007 on Limited Liability stipulates that shares, which are the capitals of a company, may be encumbered by a mortgage and a fiduciary. Stocks are

moving objects, as stipulated in Article 60 of Limited Liability Act and in accordance with with the Article No. 511 of the Civil Code. According to Act No. 42 in 1999 on Fiduciary, a stock is a moving object which can also be burdened with a fiduciary.

The Copyright Act No. 28 in 2014 on Copyrights already well contains provisions about the use of copyright as an object of fiduciary. However, more specific regulations are needed as the implementing regulations of the regulations on how copyright can be used as a fiduciary. These regulations are needed to clarify the implementation of copyright as a fiduciary object, mainly to assess the appraisal of the copyright, in order to have a clear legal certainty. Besides, bank or non-bank financial institutions need to be given information on the law in order to provide credit loans with a copyright as the collateral. Therefore, the Act No. 28 in 2014 on Copyright can be workable and useful for the society.

#### REFERENCES

- Kansil, CST and Christine S.T Kansil. (2014). Modul Hukum Perdata; Termasuk asas-asas Hukum perdata. Pradnya Paramita. Jakarta, Indonesia.
- Meliala, Djaja S. (2012). Hukum Perdata Dalam Perspektif BW. Nuansa Aulia. Bandung, Indonesia.
- M. Ponto, Chintia. (2015). Aspek Hukum Eksekusi Jaminan Fidusia Serta Implikasinya Dalam Praktik Perbankan, *Lex Privatum*, Vol. III/No. 3/Jul-Sep/2015, p. 17.
- Sofwan, Sri Soedewi Masjchoen. (1981). Hukum Perdata; Hukum Benda. Liberty. Yogyakarta, Indonesia.
- Sudjana, Hak Cipta Sebagai Jaminan Kebendaan Bergerak Dikaitkan Dengan Pengembangan Obyek Fidusia, *Jurnal Mimbar Hukum*, Volume 24, No. 3, Oktober 2012, p. 416. Yogyakarta, Indonesia.
- Widjaya, Gunawan and Ahmad Yani. (2005). Jaminan Fidusia. Raja Grafindo Persada. Jakarta, Indonesia.
- Widjaja, Gunawan. (2006). Seri Hukum Bisnis : Memahami Prinsip Keterbukaan dalam Hukum Perdata. PT. Rajagrafindo Persada. Jakarta, Indonesia.

**Topic:** Socioeconomics Relations

## **The Effect of Communication Skills on Job Opportunities for Japanese University Students**

Yosuke Yoshioka \*

*Chiba University, 1-33 Yayoi-cho, Inage, Chiba, 263-8522 Japan*

---

### **Abstract**

Regarding job opportunities for Japanese university students, the educational credentials hypothesis has been supported, which emphasizes that the students from the higher-ranked or more famous universities are more likely to become employees of larger companies. Previous studies in Japan have supported the hypothesis; whether students are hired by larger companies is significantly affected by the rank of their universities, regardless of other control variables such as their family backgrounds and their specific university experience. However, the students' communication skills have been regarded as an important factor in their job hunting (*syuu-katsu*) in Japan and they have been not included in these empirical explanatory models.

We conducted an online - based panel survey at the following two points: when students were in universities in the spring of 2015 and when they started working after graduation the following spring. Consequently, we received information from 156 respondents such as the universities they belonged to, their communication skills as measured by their assertiveness scores from their fourth year, outcomes of their seeking employment, and more.

The results obtained using multivariable analysis show that regardless of the students' assertiveness scores and the other control variables, university type affects the outcomes; students from public or high ranked private universities are more likely to be hired by larger firms or public sectors than those from other universities. We conclude that the educational credentials hypothesis is still supported in Japan after controlling for the student's communication skills.

### **Keywords**

Job opportunities; communication skills; online-based panel survey;  
Japanese university students

---

## **1. Introduction**

### *1.1. Research Question*

Regarding job opportunities for Japanese university students, the educational credentials hypothesis has been supported. This hypothesis emphasizes that the students

---

\* Tel.:+81-43-290-2290  
*E-mail address:* yoshioka@chiba-u.jp

from the higher-ranked or more famous universities are more likely to become employees of larger companies that many students wish to enter. This hypothesis has been mainly explained by signaling theory (Spence 1974), which indicates that, employers receive a signal about a students' potential ability through his or her educational credentials.

Many previous Japanese studies have shown that the educational credentials hypothesis and signaling theory are persuasive. For example, Hirasawa (2010), in his empirical explanatory model, found that outcomes of job hunting, especially whether students become employees of large companies, are significantly affected by their university types, which are classified by ranks. These two variables are interconnected in Hirasawa's model, regardless of other variables such as the students' family backgrounds, university lives, such as club activities or records, and methods of job hunting, such as utilizing institutional networks through alumni or recruiters.

However, the students' communication skills are not included in Hirasawa's model. In the traditional Japanese employment system, characterized by lower turnover rates or seniority-based wages, employers ask students not "What can you do?" but "Who are you?" They see the students' personalities as one of the most important factors in job hunting (*syuu-katsu*). Many Japanese employers evaluate the students' communication skills through oral examinations and group discussion. These skills might act as mediators between the two variables of university type and outcome of job hunting. Therefore my research question is as follows: do university types affect job-hunt outcomes regardless of students' communication skills?

### *1.2. What are communication skills?*

When we answer this research question, one of most difficult issues to be considered is identifying the communication skills that are demanded by employers in large companies? First, we focused on two previous studies, Iwawaki (2004) analyzed recruitment articles from job-placement magazines, and the Japan Institute of Labor (2000) analyzed a company survey. Both previous studies show that company recruiters in large-sized firms demanded students who acted autonomously and recruiters in middle or small sized firms demanded the ability to work cooperatively. Then, we focused on research in personality psychology. Fujimoto and Daibo (2007) found three categories of advanced communication skills of Japanese university students: assertiveness, other acceptance and regulation of interpersonal relationships. By taking account the report of Iwawaki and the Japan Institute of Labor, we hypothesized that employers in large companies demand communication skills, especially assertiveness, from Japanese university students.

## **2. Methods**

### *2.1. Online-based panel survey*

It is difficult for new workers to response past assertiveness scale, which is key concept in this research, remembering by cross-sectional survey. In order to ascertain both the students' communication skills and the final outcomes of their job hunts, we conducted a panel survey at the following two points: when students were in universities in the spring of 2015 and when they started working after graduation the following spring. It was very difficult to choose students from various universities by random sampling. We conduct an online-based panel survey. This means that we chose a sample from access panels owned by an online research agency. In early June 2015, we created a survey for senior university students who planned on graduating from 4-year colleges in March of the next year. Figure 1 shows our empirical model based upon the result of the online-based panel survey.

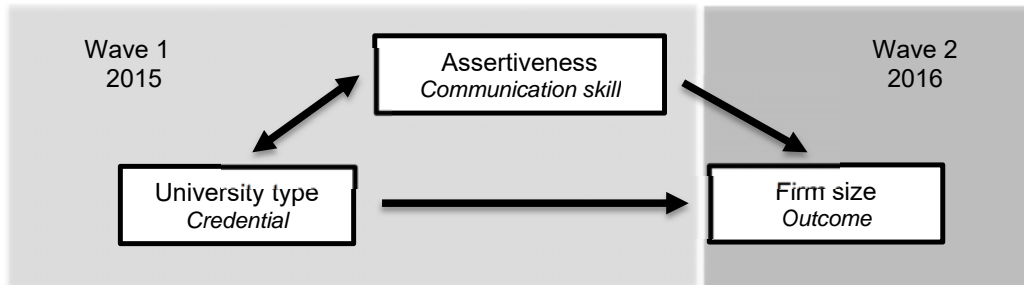

Figure 1. Empirical model based upon the results of an online-based panel survey

We restricted the cases to students wished to work and who had not yet decided upon their careers, and we excluded students who wished to go on to post graduate school. Consequently, the Wave 1 respondents comprised 500 students, an equally number of which were male and female. From the end of April to early May 2016, we followed up them. Consequently, we get information on 212 respondents in Wave 2. The ratio of follow-up was about 42%; 67 cases withdrew from the access panels, and we have been unable to contact them. If we regard the number of persons who were contacted as the denominator, the ratio of follow-up becomes about 49%. We removed some cases in which the answers about some unchanging variables were contradictory between the waves, wherein the students did not transfer from education to work, and wherein the students became either employers or self-employed in Wave 2. Consequently, in our empirical model, we were restricted to 152 employees who were holding their first jobs in 2016.

## 2.2. Variables

The main variables were university type, firm size, and the students' assertiveness. We simply divided university types into 3 categories. Group A is national and public universities. Group B is high-ranking private universities categorized on the basis of degree of difficulty of their entrance examinations. Group C is low-ranking private universities. On average, Groups A and B comprise higher-ranking, more famous universities than dose Group C.

Regarding assertiveness, we used a scale derived from a previous study (Fujimoto and Daibo 2007). The scale consists of the total scores of 4 items and has high reliability ( $\alpha = .862$ ; see Appendix for more information on these items). In our analysis, we divided the scale into 3 categories: high, middle, and low assertiveness. The each categories had almost the same frequencies.

We divided the firms where the graduates were employed by size into the following 2 categories, as was done in previous study (Hirasawa 2010); the first category comprised firms with more than 1,000 employees or that were in the public sector, and the second category included firms with fewer than 1,000 employees.

Then, we included some control variables in our model in reference to the previous research. We included gender (male / female) and major (natural science / social science and humanities). For the students' family backgrounds, we used the information about the number of household goods they had when they were 15 years old. For the students' university lives, we used information about how passionately they attended club activities and their academic performance in university classes. For methods of job hunting, we collected information in Wave 2 about whether they accessed their OB / OG and job recruiters.



### 3. Results

First, we will describe the associations found between the main three variables: university type, students' assertiveness, and firm size. These variables are interconnected as follows.

- Significant correlation between university type and students' assertiveness: The students from Groups A and B tended to have higher scores for assertiveness than those from Group C (see Figure 2).
- Significant correlation between university type and firm size: The students from Groups A and B were more likely to have become employees at large firms or in the public sector than those from Group C (see Figure 2).
- Significant correlation between students' assertiveness and firm size: The higher the level of assertiveness a student had, the more likely he or she was to have become an employee at large firm or in the public sector (see Figure 3).

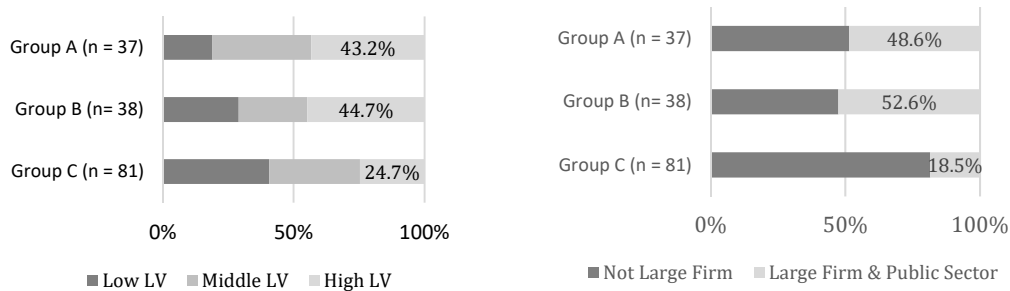

Figure 2. University type and Assertiveness (Wave1); University type and Firm size (Wave2)



Figure 3. Assertiveness (Wave1) and Firm size (Wave2)

The results obtained using multivariable analysis and a binary logit model show that regardless of the students' assertiveness and other control variables, university type affects employment-seeking outcomes; students from public or high- ranking private universities are more likely to be hired by larger firms or the public sectors than those from low- ranking private universities.

### 4. Conclusion

In our analysis, we conclude that the educational credentials hypothesis is still supported in Japan after controlling for the students' communication skills. This credential implies that direct proof of vocational skill ("What can you do?") is not as important as proof of past entrance examination efforts ("Who are you?") because,

unlike other countries, many students in Japan start to search for and secure jobs long before they graduate. This information is important to comprehending the Japanese recruitment system and job opportunities.

## **Acknowledgements**

This work was supported by JSPS KAKENHI Grant Numbers JP15K17198, JP15H03405 and JP16H03691.

## **Appendix**

4 items for assertiveness (Fujimoto and Daibo 2007) as follows. Respondents choose from 7 choices: I 'm very bad (1) ~ I 'm very good (7).

- I take the initiative in discussions.
- Without taking into account others, I define my ideas and opinions.
- In order to convince opponents, I cope with them flexibly in discussions.
- I argue logically and coherently.

## **References**

- Fujimoto, M and I Daibo. (2007). ENDCORE: A Hierarchical Structure Theory of Communication Skills. *Int. The Japanese Journal of Personality*, Vol.15, No.3, pp.347-61. Japan Society of Personality Psychology, JP.
- Hirasawa, K. (2010). Test of some hypothesis about Japanese university students' job opportunity. In T. Kariya and Y. Honda (Eds.). *The Sociology of Transition from University to Work: Empirical Studies of the Changing Mechanisms in Contemporary Japan*, p. 61-85. Tokyo University Press, Tokyo, JP.
- Iwawaki, C. (2004). A study of the Desirable Characteristics for New University Graduates: Comparative Analysis of the Published Statements of Recruiters from Large Japanese Companies 1991-2001. *Int. The Journal of Educational Sociology*, Vol.74: pp.309-27. The Japan Society Educational Sociology, JP.
- The Japan Institute of Labor (2000). *Human Resource Management for University Students in Reform Term (JIL Report No. 128)*. The Japan Institute of Labor, JP.
- Spence, M. (1974). *Market Signaling: Informational Transfer in Hiring and Related Screening Processes*, Harvard University Press, Cambridge, US.

**Topic :** Law

## **WHERE DOES THE REAL INTEREST OF SHARED FISH STOCKS IN INDIAN OCEAN STAND FOR**

**Rachma Indriyani, Moch. Najib Imanullah\***

*Faculty of Law, University of Sebelas Maret, Jl. Ir. Sutami 36A, Surakarta 57126, Indonesia*

---

### **Abstract**

The Indian Ocean is rapidly emerging as one of Prima Donna fisheries where resources exist that represent most important assets. In its development, along with the growing demands of technology and economy and food needs of each country, the exploration and exploitation of fisheries on the high seas has been increasing. The 1982 UNCLOS governs that coastal states should cooperate in the organization of sub regional and regional levels in exploring transzonal types of fish species. Common interests between countries in the high seas fisheries management is encouraging the formation of regional fisheries organization which is better known as RFMO. Through provision of the United Nations Fish Stocks Agreement (UNFSA), RFMOs are identified as key institutions bringing together countries that have a common interest in managing a particular fish stock or the fish resources of a particular region and who adopt common binding management rules that apply to all members. However this article argues on how RFMOs in Indian Ocean can guarantee access to fisheries that conform to the real interest criteria of shared fish stocks.

### **Keywords**

RFMO, Indian Ocean, shared fish stocks, the real interest

---

### **1. Introduction**

The biggest challenge for international regimes addressing common resources is that states need to establish credible principles of cooperation and mutual benefit in order to effectively tackle declining resources. The international legal regime applicable to the high seas addresses the scarcity issue in two ways: it establishes some principles of equitable use and appropriation, and it sets up institutions to manage and distribute the resources.

Intergovernmental organizations such as RFMOs set up the structure for constructive discussion and implementation of conservation measures for stock management. They provide a mechanism for nations to agree on conservation measures, but do not provide a consequential legal system for enforcement or monitoring. RFMOs, however, are notoriously weak on incentivizing compliance and sanctioning non-compliance. That kind of matter,

---

\* Corresponding author. Tel.: (+62) 82226604018  
*E-mail address:* rachma.indriey@gmail.com

somehow, are factors of what motivates States to ignore regulation and act in a manner inconsistent with international law that there is more to be gained from fishing outside international regulations than within them. As a result, the opaque commitments contained in fisheries agreements have not typically resulted in better conservation of shared resources.

Regional Fisheries Management Organizations (RFMOs) have been established, in the main, to facilitate co-operation between countries with a common interest in the management of fish stocks. Article 8(3) of the UN Fish Stocks Agreement, RFMOs are required to admit “States having a real interest” in a particular fishery. Further, Article 10 (b) the UN Fish Stocks Agreement requires States to “agree, as appropriate, on participatory rights such as allocations of allowable catch or levels of fishing effort”. Although the term ‘real interest’ is not further defined, it could be taken generally to mean any States that are interested in entering the fishery, namely new entrants. Mostly, RFMOs have been opened for its membership in categories : member and cooperating non-member. Different categories of membership imply different responsibilities. What more important is, as long as RFMOs remain unclear to determine how real interest should be interpreted and accommodated, it will produce difficulties in any stable allocation agreement, because an ever-increasing number of states may seek access to scarce resources.

A major critical issue concerning article 8 is the notion of “real interest” as it is used in paragraph 3 which reads as follows :

*“States having a real interest in the fisheries concerned may become members of such organization or participants in such arrangement. The terms of participation in such organization or arrangement shall not preclude such States from membership or participation; nor shall they be applied in a manner which discriminates against any State or group of States having a real interest in the fisheries concerned.”*

Article 8 paragraph 3 of the FSA as stated above establishes certain restrictions, namely, only states with a ‘real interest’ in the fisheries governed by the RFMO may become a member of that organization and have access. This requirement goes much further, regional fisheries may simply not be open to certain states, regardless of whether they agree to play by the rules or not.

The real interest matter is obviously related to *Pacta Tertis* principle that this provision can only apply to States which have become Parties to the 1995 Fish Stock Agreement. The privileged position given to those States in paragraph 4 as follows :

*“Only those States which are members of such an organization or participants in such an arrangement, or which agree to apply the conservation and management measures established by such organization or arrangement, shall have access to the fishery resources to which those measures apply.”* will very probably lead to arguments based on the principle of *Pacta Tertis* that this provision can only apply to those States which have become Parties to the 1995 Agreement.

Furthermore, it can be concluded that the introduction of the concept of ‘real interest in the fisheries concerned’ clarified the scope of the right and obligation of cooperation. The concept could be interpreted in two ways. First, the concept can be interpreted to mean that states are entitled to participate in RFMO on the ground that they have a real interest. Second, such states may become members of or participants in RFMO with the competence to establish conservation and management measures. The terms of participation of such RFMO shall not preclude such states from membership or participation, nor shall they be applied in a manner which discriminates against any state or group of states having a real interest in the fisheries concerned. First and foremost, high seas fishing states

are qualified as having a real interest. Next questions arise such as to what extent the state concerned needs to be engaged in the fishery or research and whether the intention to engage in the fishery or research or past fishing record qualify the state whatsoever.

That is clearly define in determining which States could be subject to member countries, RFMOs require its member who wish to join membership should be based on real interest of fisheries criteria. However, they have no more elaboration on this problem, but in practical matter, somehow, quota allocation would be determined by catch history record.

Joyner and DeCola write: “[t]rue, all states may in principle enjoy the same rights to exploit living resources of the high seas. But, it is believed, only states having distant-water fishing fleets will be able to harvest them without having to share benefits with other nations”. If the coastal state in the region cannot afford to invest in costly high seas fishing fleets, the special recognition of developing states through, say, favourable allocation of fishing opportunities will not be meaningful unless the entitlement is transferrable to other states. The increased participation in high seas fisheries through support activities might be one solution particularly where the stock is fully-exploited and the states should not develop their fishing capacities.

## 2. Recent Development in High Seas : From Open Access to Upscale Club

The development of high seas fisheries policy and management in general can be classified into three distinct phases. The *first phase* was the period until the 1970s when most parts of the world’s oceans were international waters marked by open-access fisheries, while the coastal states’ jurisdiction over maritime zones did not encompass but a narrow belt of three nautical miles along the coast lines. This phase saw a considerable increase of both fishing effort as well as advances in technology which allowed greater catches. At the same time states perceived the need for cooperation on the regional level so as to reduce resource conflicts and to prevent overfishing on the high seas. The first fisheries management bodies were established. The *second phase* was that of the “enclosure of the seas” from the mid-1970s through the extension of coastal state jurisdiction to 200 nautical miles and the reduction of the scope of international fisheries management following UNCLOS III. The development of high seas fisheries management entered into its *third phase* in the early 1990s with the international community’s growing concern about overfishing and the adoption of groundbreaking political and legal instruments such as the 1992 Rio Declaration, the 1995 UN Fish Stocks Agreement and the 1995 FAO Code of Conduct for Responsible Fisheries, which created a whole new framework for the governance of high seas fisheries. To these three phases can be added a *fourth phase* which has seen the adoption of various international instruments into reformed Conventions and RFMO practices. This has also seen the implementation of the principles in these instruments in practice.

Until recently, open access meant that all nations could navigate freely and exploit the resources of the high seas. The right of open access, however, is no longer absolute. Two global treaties that form the building blocks of the legal framework applicable to the high seas temper this principle.

### 2.1 *The 1982 UNCLOS*

The 1982 United Nations Convention on the Law of the Sea (UNLCOS) states that all States have the freedom to sail fishing vessels flying their flag on the high seas. An essential

prerequisite to operating a ship on the high seas is thus for the ship to acquire the flag of a State, usually through the act of registration of that ship with the State. Because the high seas are not subject to the jurisdiction of any State, in order to preserve public order, the right to navigate on the high seas must be restricted to those vessels, which through their link to a State, are subject to its jurisdiction and can therefore be held to account for compliance with international rules to which the State subscribes. Article 87 (2) of the UNCLOS qualifies the right by linking open access to the interests of other states. The UNCLOS at Article 91 allows for every State to fix conditions for the grant of its nationality to ships, for the registration of those ships and for the right to fly its flag with the requirement that there must be a genuine link between the State and the ship. It doesn't specify the definition of genuine link should be, leaving room for vessel owners to register their vessels with the States implementing the weakest conservation and management measures

Article 116 and 117 of UNCLOS similarly subjects the right of open access to other treaty obligations (like obligations under RFMOs), and to the rights, duties, and interests of coastal states in relation to fisheries governance. Equally relevance Article 118 is the duty UNCLOS places on all States to co-operate in the conservation and management of living resources of the high seas, including through the establishment of regional and sub regional fisheries management organizations. Thus, while UNCLOS reaffirms the right of open access, it imposes important restrictions on state use of scarce natural resources, and most provisions of UNCLOS are considered to constitute customary international law

## 2.2 *The 1995 UNFSA*

The provisions of UNCLOS have been elaborated in the 1995 United Nations Fish Stock Agreement (FSA) that augments the legal regime applicable to straddling and highly migratory fish stocks for its seventy-seven members. The purpose of the FSA is to ensure the long-term conservation and sustainable use of straddling fish stocks and highly migratory fish stocks through effective implementation of the relevant provision of the Convention. In particular, the FSA requires states parties to adopt measures of conservation and management, and cooperate in accordance with the convention on (i) measures to ensure long-term sustainability, (ii) use of the best scientific advice, and (iii) the prevention or elimination of overfishing. It imposes a duty to cooperate by providing that members, and those who want to access resources, have to respect a management regime. It also stipulates that parties who are not members of the regional regimes, or who refuse to apply conservation measures, can be denied access to the fishery resources. Nonetheless, unless provisions of the FSA evolve into customary international law, they do not create obligations for third parties. Second, the FSA does not specifically address allocation, although it determines the high seas component of straddling and highly migratory fish stocks, and the distribution of high seas portions of stocks between RFMO member states and non-member states.

## 3. The Real Interest of RFMO membership

In addition to making access to RFMOs upon its membership, Article 8 (3) of the FSA establishes certain restrictions, namely, only states with a 'real interest' in the fisheries governed by the RFMO may become a member of that organization and have access. This requirement goes much further, regional fisheries may simply not be open to certain states, regardless of whether they agree to play by the rules or not. This is not merely a condition of the exercise of the freedom to fish, it is an exception to this venerable principle. The practical

necessity of such a limitation on membership arises from the fact that many of the world's fisheries are already fully exploited or over-exploited.

Most RFMOs allow any state to join, even states that are not located in the region (the so-called distant water fishing nations). Moreover, an increasing number of RFMOs permit non-parties to adhere to the goals of the organization as non-contracting members in order to increase compliance.

Another weaknesses in RFMO governance are widely acknowledged as a driver of the allocation problem. As Meltzer writes, "the determination of allocations is often a bitter behind-the-scenes 'horse-trading exercise'(based on political leverage and negotiated exchanges) that can be a less than effective means of deciding how the fish pie is split . . . ." RFMOs are created and run by states. Each state gets one vote; no RFMO permits non-state actors like nongovernmental organizations (NGOs) into the decision-making process directly, although many grant NGOs observer status.

### 3.1 *New Entrant Problem*

The larger the number of participants, the harder it is to achieve a stable cooperative arrangement with equitable allocation arrangements. Broader membership aimed to increase compliance, at the same time, broad membership also creates the unfinished issue of new entrants. All states are expected to do conservation on fisheries stock through management of RFMOs, meanwhile it is also difficult at making stable allocation agreement. Accepting a new entrant and offering access to the resource would mean lower catch possibilities for existing member countries. That matter could be arisen to another possibilities that whether RFMOs should open new fisheries area to accommodate new entrants. In practice, where access to the resources managed by the RFMO has not been formally allocated, a new entrant may be at a significant disadvantage. Even if an RFO is able to agree on the level of quotas for fish stocks, equally difficult decisions are necessary on how to allocate that quota among the member countries.

Some States which are members of RFMOs may resist the new members for fear of losing a share in fisheries which are already fully exploited or over-exploited thereby encouraging the possibility of non-members with an interest in the fishery to engage in unauthorised fishing activities. Additionally, members may be reluctant to share the returns of their investment in the fishery with new-comers. A new comer admitted into such a fishery will be considered to be a "free rider" whose participation could result in non-cooperation by the existing members. In situations where tuna stocks are oversubscribed and fully allocated among members of an RFMO, cooperation within the framework of the RFMO may then result in the adoption of new allocation criteria. Nonetheless, it is suggested that, according to Article 8(3) and (4) of the UN Fish Stocks Agreement, new entrants must be offered a 'just and reasonable' share of the TAC (Total Allowable Catch) under an RFMO management plan.

Most organizations also do allocation based upon historical catch records, so that each country has a fixed percentage of the quota. There are two primary reasons why this measure is ubiquitous. First, historically, past catch has been viewed as fair by states. Second, historical catch is reasonably easy to quantify. Historical catch favors existing players, and therefore acts as a disincentive for states that are not currently members of RFMOs to join. Historical catch reflects the policy preference of the original members of the organizations, illustrating that redistribution is not a major objective in most of the international organizations tasked with managing the high seas.

From contrary perspective, that equally important to be considered, what about countries which have not formerly fished a particular stock but wish to develop their fishery? Where a state has little or no catch history, the chances of receiving a viable allocation would appear to be slim. Equally important, how do we ensure that developing countries have the opportunity and human and financial resources to first, engage with RFMOs managing stocks that partly occur in their EEZs to ensure that they regulate fishing in their EEZs in a sustainable way and that the RFMO ensures sustainable exploitation of these stocks outside their EEZs, and second, participate in high seas fisheries if they wish to? Most States, particularly developing coastal States are not able to determine the TAC for lack of financial and technical resources, moreover many developing States are still lack of sophisticated on either equipment or size of fleets. In result, broad access obscures the identity of the real parties in interest to fish on the high seas.

### 3.2 *Indian Ocean Tuna Commission (IOTC)*

The Indian Ocean Tuna Commission (IOTC) is an intergovernmental organization mandated to manage tuna and tuna-like species in the Indian Ocean and adjacent seas. The Objective of the Commission is to promote the conservation and optimal utilization of tuna and tuna-like stocks covered by the IOTC Agreement, and to encourage sustainable development of fisheries. In accordance with Article V of the IOTC Agreement, the main functions of the IOTC are to keep under review the conditions and trends of the stocks and to gather, analyse and disseminate scientific information, catch and effort statistics and other relevant data. The current status of the stock in areas which covered by IOTC had suspected overfished and overfishing. Unreported/underreported/misreported fishing, transshipment and collaboration with Irregulated Unreported Unregulated (IUU) listed vessels are another main issue in this area.

One of the most difficult tasks for the RFMO institution is to keep members motivated to continue membership and participate in the conservation of the fish stocks. If this balance is not achieved, motivation can move in the direction of free riding and non cooperation. In the case of the RFMO, the management structure must be self enforcing since there is no independent third party enforcement agency, and no court system. If the fish stock collapses, the RFMO will have failed in its mandate to conserve the high seas, what's more there are no real world consequences for such condition. Importantly, RFMOs are only accountable to their members and as such if an RFMO is underperforming there are no formal higher-level accountability arrangements to ensure that performance improves. Therefore, to detect and deter such non compliance, strong measures are needed to ensure the integrity of allocations should be implemented, including penalties for breaches of national allocation and reductions in allocations for breaches of other conservation measures. One fundamental approach that could be better employed for RFMOs is to limit or deny access to the fisheries resources under their purview to fishing vessels of members that do not comply with the measures adopted by the RFMOs, including any obligations to report fisheries data. Another approach is for all members of RFMOs to deny licenses to fish and port access to any vessels identified by the RFMO as having been involved in IUU fishing, even if the vessels have subsequently been renamed or registered in new States.

In overcoming quota allocation for each member, basic principle must be considered, *inter alia*, first, the development and implementation of quota allocation system should ensure the sustainability of fish stock. For that matter, a portion of the stock should be allocated to reserve stock or for the new entrance. The sum of all countries quota should not exceed the Total Allowable Catch (TAC). Second, the utilization of the resources should be



distributed among members that consider historical management, geographic location/proximity to the resources, the fisherman livelihood and the socio economic level of development of the country. Last, the quota allocated for each country should be given to the member country based on their membership statute and their level of compliance to the IOTC resolutions.

#### **4. Conclusion**

The common pool nature of the international fisheries regime is such a trigger for fisheries activity. Under this regime, the freedom to fish the high seas is granted to all States equally and as such the individual fisher has every incentive to regard such fisheries resources as if they were non-renewable. In effect, any of individual fisher acting to conserve and invest in marine resources would be making an unsound and irrational commercial decision. In such system, the over-exploitation of marine resources will occur unless all States find the political will necessary to exercise control over vessels registered to their flag.

RFMOs have an important role to play in the system of global fisheries governance. As international fora, they are the primary mechanism that allows for co-operation between and among fishing countries and coastal States in line with the requirements and responsibilities under UNCLOS and the UNFSA. Their role is particularly important for the conservation of straddling and highly migratory fish stocks which often move from a country's EEZ to another or to the high seas. Stocks of such fish species can be sustainably fished only if coordination across all the different zones inhabited by the stock allows for coherent management.

However, it is acknowledged that the articulation of such a policy would not be easy given the provisions of Article 116 of UNCLOS and Article 8 of the UNFSA. It remains unclear as to how 'real interest' should be interpreted and accommodated. It should be noted that there appears to be an inherent tension between provisions which provide for 'real interest' and the global community's desire for healthy fisheries and ecosystems. From many RFMOs experiences, nations which are not members in regional bodies, as such they not abide to convention, have prioritised their merely socio- economic interest rather than conservation measures. As a result, the opaque commitments contained in fisheries agreements have not typically resulted in better conservation of shared resources.

#### **References**

- Andrew Serdy. (2011). *Postmodern International Fisheries Law, or We are All Coastal States Now*, 60 INT'L & COMP. L.Q
- Elise Anne Clark. (2011). Compliance Enforcement in Regional Fisheries Management Organisations to which Australia is a Party. Faculty of Law, University of Tasmania Hobart
- Erik Franckx, (2000). Pacta Tertiis and the Agreement for the Implementation of the Straddling and Highly Migratory Fish Stocks Provisions of the United Nations Convention on the Law of the Sea
- Gordon R Munro. (2003). Implementation of the Provisions of the UN Fish Stocks Agreement: Conditions for Success- The Case of Developing Fishing Nations in IDDRA, *Policy Research: Options for Strengthening National, Sub-regional and Regional Institutions and Policies to better Address Developing Countries' Needs\**

- G.T. Crothers, L. N. (2007). High Seas Governance: A Framework for the Future? . Marine resource Economics Volume 21
- Joyner and De Cola, Chile's Presential Sea Proposal, in Yoshinobu Takei. 2008. Filling Regulatory Gaps in High Seas Fihseries : Discrete High Seas Fish Stocks, Deep-Sea Fisheries and Vulnerable Marine Ecosystems.
- Kristen E. Boon. Overfishing of Bluefin Tuna : Incentivizing Inclusive Solutions, Journal of University of Louisville Law Review, Vol. 52:1
- Mbendo Jane Rowena. (2011). Management of tunas in the Indian Ocean: a study of Kenya's Implementation of international and regional conservation and management measures for Tuna, Doctor of Philosophy thesis
- Michael W Lodge et al. (2007). Recommended Best Practices for Regional Fisheries Management Organizations : Report of An Independent Panel To Develop A Model For Improved Governance By Regional Fisheries Management Organizations.
- Patricia Devaney. (2005). Regional Fisheries Management Organizations: Bringing Order to Disorder. Papers on International Environmental Negotiation
- Peter Orebech et al. (1998). The 1995 United Nations Straddling and Highly Migratory Fish Stocks Agreement: Management, Enforcement and Dispute Settlement. The International Journal of Marine and Coastal Law, 119, 126.
- Strengthening Regional Fisheries Management Organisations. 2009. OECD
- Willcock, A. et al. (2006). Follow the leader : Learning from experience and best practise in regional fisheries management organizations. WWF International and TRAFFIC International.

**Topic:** Humanities

## **Our use of Descriptive Names and Singular Thoughts**

Satsuki Ikeda

*Graduate School of Humanities and Social Sciences, Chiba University, 1-33 Yayoi-cho,  
Inage-ku, Chiba City, 263-8522, Japan*

---

### **Abstract**

A descriptive name is a name whose reference is exclusively fixed by a definite description. In using a descriptive name, we have a descriptive thought that contains, as its component, the general concept expressed by the name's reference-fixing description. However, I believe that in using a descriptive name, we sometimes have a singular thought, or a thought that does not comprise such a general concept but in fact comprises the name's referent itself. To support my view I will first survey two prominent theories on this issue—Acquaintance Theory and Semantic Instrumentalism. Acquaintance Theory claims that in order to have a singular thought, we must first have an acquaintance relation to the object in question. This means that in using a descriptive name, we can never have a singular thought about its referent. On the other hand, Semantic Instrumentalism maintains that by simply using a descriptive name, we can always have such a singular thought, regardless of whether the very referent exists or not. In my opinion, the former idea is wrong in taking an acquaintance relation itself as a necessary condition for our grasp of singular thoughts, and the latter idea is implausible in that it cannot offer any tenable grouping of singular thoughts. Considering this, I will argue that it is our possession of proper information that is really essential to our grasp of such a thought, and we inevitably rely on our linguistic and social activities to obtain the appropriate kind of information.

### **Keywords**

Acquaintance; Descriptive Names; Information; Singular Thoughts

---

### **1. Introduction**

Suppose I wish to own a book-shop one day and name the shop "Sunny Sides." This name would refer to whatever uniquely satisfies the description "the book-shop that I own." "Sunny Sides" is a typical descriptive name, or a name whose reference is exclusively fixed by a definite description<sup>1</sup>. Moreover, it is generally believed that in using a descriptive name, we have a descriptive thought that comprises, as its component, the general concept expressed by the name's reference-fixing description<sup>2</sup>. However, I

---

<sup>1</sup> Famous examples of actual descriptive names include "Unabomber," which will be discussed later, and "Vulcan," which referred to the planet that was assumed to be circling inside Mercury's orbit. Examples of theoretical descriptive names include "Julius," which refers to the inventor of the zip (Evans (1982), (1985b)), and "Newman 1," which refers to the first baby born in the 21st century (Kaplan (1989a)), etc.

<sup>2</sup> Gareth Evans evidently supports this conclusion (Evans (1985b)) despite offering detailed arguments that seem to provide strong grounds against it (Evans (1982), (1985a)). My discussion in this paper draws considerably from those arguments, which claim that it is our possession of information derived from the relevant object that plays an essential

propose that in using a descriptive name, we sometimes have a singular thought, or a thought that does not comprise a general concept but the name's referent itself. This paper will support this view and clarify how we can arrive at a singular thought while using a descriptive name.

## 2. Preliminary Discussions

### 2.1. *Two theories considered*

To have a singular thought about an object is to think about the very object in question. This characterization implies that in order to have a singular thought, we have to think of an object in a very distinct way without thinking of it as the unique satisfier of any description. Consequently, what are the conditions required for us to have a singular thought? Concerning this, Robin Jeshion once pointed out two extreme positions and argued that one of them claimed too strong a condition for our having a singular thought about an object, and the other too weak a one<sup>3</sup>. To begin with, I would like to give a brief overview of these two positions—Acquaintance Theory and Semantic Instrumentalism—because I believe that each of them does include something worth serious consideration, although they do not seem to be tenable as they are just as Jeshion insisted.

Acquaintance Theory claims that, in order to have a singular thought, we must first have an acquaintance relation to the object in question. This claim requires that someone in our language-speaking community is acquainted with the object and identifies it as the unique bearer of the name<sup>4</sup>. However, a descriptive name is a linguistic device that is introduced into our language-speaking community without any relation to such an acquaintance or acquaintance-based identification. The use of a descriptive name in itself clearly does not constitute any acquaintance relation between the user of the name and the name's referent. If such a relation does exist between the user of the name and its referent, the name would not function as a descriptive name but would refer to the relevant object based on that acquaintance relation. In other words, its reference would not be exclusively confined by a definite description. Thus, Acquaintance Theory denies any possibility of our having a singular thought about the relevant object while using a descriptive name. This position, which may be characterized by the slogan “no acquaintance, no singular thought,” seems to have been the most widely accepted view in the philosophy of language<sup>5</sup>.

On the other hand, Semantic Instrumentalism, as Jeshion specified it, stands out by its rather liberal attitude toward the question at hand. According to this position, we can have a singular thought about the referent of a descriptive name simply by using the very name, given some other minor conditions are satisfied. Indeed, it even claims that we can have a singular thought about an object that has not yet come into existence, on the condition that we can construct and use a descriptive name whose reference is fixed by a definite description that is uniquely satisfied by the object in question. Thus, if Semantic Instrumentalism is correct, we can have a singular thought about any object from the past, present, or future, as long as we can construct and use an appropriate descriptive name, or, as Jeshion defined it, “descriptively introduced referential terms” (DIRTs)<sup>6</sup>.

### 2.2. *Singularity of thoughts*

According to Semantic Instrumentalism, we can have a singular thought simply by using a descriptive name, which means that in using the name, we can have a type of thought that cannot be obtained by thinking of the referent as the unique satisfier of any description. Given that the reference of a descriptive name is exclusively fixed by a

---

role in our grasp of a singular thought.

<sup>3</sup> Cf. Jeshion (2010).

<sup>4</sup> Cf. Jeshion (2010), p. 109.

<sup>5</sup> For example, Bach (2008), Evans (1985b), McCulloch (1985), Recanati (2010), etc.

<sup>6</sup> DIRTs are a group of linguistic devices whose references are exclusively fixed by a definite description (cf. Jeshion (2010), p. 105). Instead of proper descriptive names, those terms include Kaplan's so-called “dthat” expressions (cf. Kaplan (1989a), especially p. 521) and deferred pronouns or demonstratives.

definite description, this idea is rather problematic to support and has actually raised some powerful arguments contradicting it. For example, Evans (1985b) maintains that the sentence “Julius is F”—formed by using a descriptive name “Julius” whose reference is fixed by the definite description “the inventor of the zip”—has exactly the same content as the sentence “The inventor of the zip is F.” In other words, according to Evans, we come to grasp exactly the same *descriptive* thought when we understand these two sentences. However, if Semantic Instrumentalism is right, our introduction, and use of a descriptive name of itself should enable us to have a singular thought about its referent. Evans criticizes this by saying that it is implausible that we can create a completely new type of thought just by “the stroke of a pen.”<sup>7</sup> However, I think that the most serious problem with Semantic Instrumentalism lies in the fact that it cannot give us a tenable grouping of singular thoughts in the first place. If we are to classify a group of thoughts into a unified category, that categorization should be related to some distinctive character of our behavior and psychology, which can be explained by the underlying thoughts of that category. The problem is that there is no distinctive character of our behavior and psychology which is observed in *all* the cases of our use of a descriptive name, that is, in *all* the cases of our having a “singular thought” as Semantic Instrumentalism calls it. For example, my behavior and psychology when using “Sunny Sides” in the situation described above, will be quite different from when I use the name after I actually open the book-shop. It is essential that we acknowledge this difference if we are to correctly understand my use of the name “Sunny Sides” in each situation. The concept of thought is primarily connected to this kind of difference, which shows how we understand the term in question. However, we will end up cutting off that connection if we conclude, according to Semantic Instrumentalism, that I have exactly the same “singular thought” in both situations. As far as I can see, our idea of singular thought as a thought about a particular object entails that an object does, or did, exist. This, in turn, seems to suggest that singularity of thought, as we understand it, depends on there being a substantial connection between the subject and the object that can be manifested as a change in the subject’s state of knowledge according to the object’s state of affairs. Of course, we cannot expect any non-existent object to have such a causal effect on the subject’s state of knowledge. This clearly has something to do with the difference of my behavior and psychology observed in the two cases of my use of “Sunny Sides” mentioned above. Given all this, our grasp of singular thoughts, or thoughts about a particular object, cannot simply depend on our action or manipulation, such as our use of descriptive names. Rather, it must be a matter of that substantial connection between the subject and the object, which is manifested as a systematic change in the subject’s state of knowledge, and behavior and psychology, based on the object’s state of affairs.

Thus, if this kind of connection always requires the subject to have an acquaintance relation to the object in question, we will be forced to conclude that our use of a descriptive name can never involve our grasp of singular thoughts about the referent of that name. In my opinion, however, the connection cannot be constituted by the acquaintance relation itself. Certainly, if the acquaintance relation does hold between the subject and the object, there must be, or have been, an object to be thought about anyway. In addition, if the subject himself is currently perceiving the object, or remembering his own experience of having perceived it, we may be allowed to say that the subject is connected to the object in the manner required for having a singular thought about it. However, as Jeshion argued, when the subject is acquainted with the object via a communication chain, that is, on the basis of some other person’s experience of having perceived the object, it is difficult to explain how the subject can have a singular thought (if any) about the object, given that our experience can never be transferred to another person<sup>8</sup>. An acquaintance relation that extends between the subject and the

---

<sup>7</sup> Cf. Evans (1985b), pp. 200-202.

<sup>8</sup> Cf. Jeshion (2010), p. 110.

object as long as someone in the relevant community has perceived the object and identified it as a unique bearer of the name in question, seems to give us a merely partial explanation of how to grasp a singular thought about that object.

If such a connection actually extends between the subject and the object, we can expect the subject's state of knowledge to change according to the object's state of affairs. From time to time, such a connection is sustained because of a communication chain between the subject and the object, even if the subject has not perceived the object himself. For example, we can gain information about the words and actions of a person we have never met through communicating with others. Based on that knowledge, we often form a certain opinion about the person, which will naturally change as we acquire more information about him. This observation suggests that what constitutes a proper connection and makes our thought a singular thought about a particular object, is *not* any perceptual experience of that object by someone in the relevant community, *nor* any acquaintance relation which originates from that perceptual experience for that matter. Rather, it is information that is often received from the object and transferred to the subject through an acquaintance relation that constitutes the required substantial connection between the subject and the object<sup>9</sup>. This type of information, unlike perceptual experience, can certainly be transferred to the subject who has never perceived the object through a communication chain as mentioned above. It is quite remarkable to see the power of that substantial connection, of affecting the subject's state of knowledge, ultimately consisting in this type of information that is transferred to the subject and sometimes updated. Moreover, this information is not necessarily obtained by someone's perceptual experience of the object in question, but can be derived from the works created by the object, or historical material that tells us about the object's words or actions. If all these considerations are correct, we can say that Acquaintance Theory has identified the means to receive and transmit this type of information, that is, a perceptual experience of the object in question and an acquaintance relation that originates from such an experience. However, as I see it, to have a singular thought about an object is to acquire information from the very object itself, and that is quite different from having an acquaintance relation to the object in question through which we can sometimes receive or transmit information.

### 3. Case Studies

#### 3.1. *Recapitulation and ensuing deductions*

Once again, what is essential to having a singular thought about a particular object is, in my opinion, a precise connection to the object in question. Moreover, if I am right in my assumption that this kind of connection does not depend on having an acquaintance relation to the relevant object, there seems to be no obstacle for sustaining such a connection between the user of a descriptive name and the name's referent as long as the referent really exists, or existed. In this section, I would like to examine some real cases of our use of a descriptive name, and clarify in more detail how such an exercise can involve our grasp of a singular thought of the relevant object.

#### 3.2. *Two cases considered*

The first case we shall deal with is one where the descriptive name has, as its referent, an object that actually exists, or existed. However, even an examination of such a case cannot conclude that all such cases of our use of a descriptive name involve our grasp of a singular thought about its referent. For example, let us now introduce a descriptive name "Conan" by means of fixing its reference through the definite description "the last Naumann's elephant which lived in Hokkaido." This descriptive name clearly satisfies the condition that it has, as its referent, an object that must have really existed in Hokkaido. However, given the arguments in the previous section, it is difficult to contend

---

<sup>9</sup> Cf. Evans (1982), (1985a) and footnote 2.

that we can arrive at a singular thought about Conan in using “Conan,” because we do not have any information, which can claim to have received from that particular Naumann’s elephant. Thus, we are not connected to Conan in the manner required for having a singular thought about it. This means that our state of knowledge, and our behavior and psychology cannot be affected by Conan’s state of affairs. At most, we can conclude that, in using “Conan,” we have a general thought, which involves a general concept expressed by the name’s reference-fixing description. In this type of case, where a descriptive name is introduced in an entirely ad-hoc manner, we can naturally conclude that in using a descriptive name we can never arrive at a singular thought about its referent. Indeed, some influential discussions about the relation between our use of descriptive names and singular thoughts have focused on this type of ad-hoc descriptive names<sup>10</sup>.

However, there is another type of case where the user of a descriptive name has a more substantial knowledge about the referent. One example is the use of the descriptive name “Unabomber” before its referent was identified. This descriptive name was introduced to refer to the person responsible for the serial bombings that occurred between the late 1970s and the 1990s in the United States of America. The Unabomber, later identified as Theodore Kaczynski, repeated the offense 16 times, targeting airline companies and universities, until his arrest in 1996. He even claimed responsibility for the bombings through a leading newspaper. Naturally, people who lived in the USA at that time must have used the name “Unabomber” while discussing his character, actions, and motives, even before he was actually identified. It is not too difficult to believe that some of them might have even refrained from visiting airports or universities because of such conversations. As far as I can see, we essentially behave the same way with regard to people who have already been identified in our language-speaking community, such as Abraham Lincoln or Adolf Hitler. We discuss their personalities or influences, express various emotions toward their behavior, and decide to adopt or avoid a certain action based on such discussions or emotions. Of course, the point here is that in both cases the subject’s behavior and psychology seem to be significantly affected by information about a certain object, which the subject himself has never perceived. Not only in the latter case where an object has already been identified as the bearer of the name at hand, but also in the former case where such an identification is yet to be made, the subject seems to receive information from the relevant object and, therefore, is in a position to have a singular thought about it<sup>11</sup>.

### 3.3. *Non ad-hoc or “information-based” use of descriptive names*

In using a descriptive name, if we compare the way “Unabomber” was introduced and used with the way “Conan” was, we will observe a distinctive feature, which seems to play a crucial role in our grasp of a singular thought about the relevant object. Mainly, our positive involvement in collecting and communicating information derived from the very object by using the exact name. “Unabomber” was first introduced into the relevant community against a very different background from the case of “Conan,” in that, from the outset, the name “Unabomber” was linked with information derived from its referent since the police must have obtained some information from the Unabomber during their investigation. Indeed, it was exactly because such information had been obtained that they introduced the descriptive name “Unabomber.” In other words, “Unabomber,” unlike “Conan,” was not introduced into the relevant community in an ad-hoc manner. Rather, it was introduced in connection with some information from its referent in the first place with the intention of being used to collect and communicate relevant information that would be accumulated and updated as time went by. When the name became common knowledge in the community, information from the Unabomber also was transferred by

---

<sup>10</sup> “Julius” and “Newman 1” mentioned in footnote 1 are typical examples of ad-hoc descriptive names.

<sup>11</sup> As was discussed in the previous section, identification of the object in question, or an acquaintance relation between the subject and the object based on such an identification, is different from the subject’s possession of information from the very object.

using the name more widely than ever before. This strikingly contrasts with the case of “Conan,” whose use was a completely personal matter and did not amount to any collection and communication of information from its referent. In short, our introduction and use of “Conan” had nothing to do with our collecting and communicating information from the relevant object, which should be characterized as an essentially linguistic and social activity. On the other hand, the introduction and use of “Unabomber” was indeed related to that kind of activity, and the fact that it actually provided people with the right kind of information, was ultimately responsible for their grasp of a singular thought about the Unabomber. Of course, information that was communicated using “Unabomber” may have included those that did not originate from the Unabomber at all. If no information from him had been included, then, while using the descriptive name, the subject could have grasped no singular thought about the Unabomber. In reality, however, more and more information from the Unabomber came to be connected with “Unabomber” as he repeated offenses. This is crucial for people to have a singular thought about him, given that their possession of such information plays an essential role in their grasp of such a singular thought. The subject who did obtain some information from the Unabomber must have been able to grasp a singular thought about him while using “Unabomber,” even if he connected other information that did not originate from the Unabomber with “Unabomber”. If the subject found some incorrect information in connection to “Unabomber,” he would have immediately discarded it. This suggests that it was only information from the Unabomber that could affect the subject’s behavior and psychology. Thus, only the Unabomber could be connected to the subject in a way that characterized the grasp of a singular thought about a particular object.

#### 4. Concluding Remarks

If all these considerations are on the right track, it follows that our use of descriptive names, which is meant to be a linguistic and social activity like the example given above, can actually widen the range of objects of which we can have a singular thought. If that is the case, it follows that descriptive names are uniquely important for our having a singular thought about a variety of objects that exist or existed throughout the world. In fact, the following passage suggests that a more or less similar view may underlie Semantic Instrumentalism.

“...The notion that a referent can be carried by a name from early past to present suggests that the language itself carries meanings, and thus that we can *acquire* meanings through the instrument of language. This frees us from the constraints of subjectivist semantics and provides the opportunity for an *instrumental* use of language to broaden the realm of what can be expressed and to broaden the horizons of thought itself. / On my view, our connection with a linguistic community in which names and other meaning-bearing elements are passed down to us enables us to entertain thoughts *through the language* that would not otherwise be accessible to us. Call this *the Instrumental Thesis*. / ...It urges us to see language, and in particular semantics, as more autonomous, more independent of the thought of individual users, and to see our powers of apprehension as less autonomous and more dependent on our vocabulary.”<sup>12</sup>

Of course, Semantic Instrumentalism emphasizes the point that our use of a descriptive name of itself allows us to grasp a singular thought about its referent. However, the passage cited above clearly requires us to be connected to some or other language-speaking community in order to grasp such a thought. The problem, in my view, is that Semantic Instrumentalism has interpreted this connection as having nothing to do with our linguistic and social activity discussed above, which is collecting and communicating information from the relevant object. If my arguments so far are correct, we are forced to

---

<sup>12</sup> Kaplan (1989b), pp. 603-604.



conclude that, even in the case of an ordinary proper name from which the passage starts its consideration, our receiving and holding information from the referent is what is essential for us to have a singular thought about it. This information is often transferred to us through the linguistic and social activity carried out by using the very name. Thus, Semantic Instrumentalism makes a good point in stating that our use of descriptive names against a background of some language-speaking community would enable us to have a singular thought that would otherwise not be accessible to us. However, it would be a grave error to conclude that our use of descriptive names *quite generally* enables us to have a singular thought about its referent, regardless of whether the use is related to any linguistic and social activity.

## 5. References

- Bach, K. (2008). What does it take to refer? In Lepre, E. and Smith, B. eds., *The Oxford Handbook of Philosophy of Language*, pp. 516-554. Oxford: Clarendon Press.
- Evans, G. (1982). *The Varieties of Reference*, Oxford: Clarendon Press.
- Evans, G. (1985a). The Causal Theory of Names. In Evans, G., *Collected Papers*, pp. 1-24. Oxford: Clarendon Press.
- Evans, G. (1985b). Reference and Contingency. In Evans, G., *Collected Papers*, pp. 178-213. Oxford: Clarendon Press.
- Jeshion, R. (2010). Singular Thought: Acquaintance, Semantic Instrumentalism, and Cognitivism. In Jeshion, R. ed., *New Essays on Singular Thought*, pp. 105-140. Oxford: Oxford University Press.
- Kaplan, D. (1989a). Demonstratives. In Almog, J. et al. eds., *Themes from Kaplan*, pp. 481-563. New York: Oxford University Press.
- Kaplan, D. (1989b). Afterthoughts. In Almog, J. et al. eds., *Themes from Kaplan*, pp.565-614. New York: Oxford University Press.
- McCulloch, G. (1985). A Variety of Reference? In *Mind*, 94 (376), pp. 569-582.
- Recanati, F. (2010). Singular Thought: In Defense of Acquaintance. In Jeshion, R. ed., *New Essays on Singular Thought*, pp. 141-189. Oxford: Oxford University Press.

**Topic : Humanities**

**Ecological Anthropological Analysis of Nyale Foraging and the  
Sasak Calendar System in Lombok**

Shingo Odania<sup>a\*</sup>, Takuro Furusawa<sup>b</sup>, Masanori Sato<sup>c</sup>, and Hana Shimizu-Furusawa<sup>d</sup>

<sup>a</sup>*Faculty of Letters, Chiba University, 1-33 Yayoicho, Inage, Chiba, 263-8522, Japan*

<sup>b</sup>*Graduate School of Asian and African Area Studies, Kyoto University, Yoshida-Honmachi, Sakyo-ku, Kyoto 606-8501, Japan*

<sup>c</sup>*Research Field in Science, Science and Engineering Area, Kagoshima University, Kagoshima 890-0065, Japan*

<sup>d</sup>*Department of Gene Diagnostics and Therapeutics, Research Institute, National Center for Global Health and Medicine, 1-21-1 Toyama, Shinjuku-ku, Tokyo 162-8655, Japan*

---

**Abstract**

In Lombok Island of West Nusa Tenggara province, Indonesia, Nyale foraging is observed annually only at the spring tide around February. Nyale worms, which are identified into the family Eunicidae of Annelida, behave in mass spawning for reproduction once a year. Around West Nusa Tenggara province, people forage a part of Nyale bodies containing sperm and eggs for self-consumption or selling in market. Nyale are assumed to be rich in protein and micro-nutrients, hence people think Nyale consumption to enhance their health condition.

When viewed from a cultural issue, Nyale foraging in Lombok accompanies Bau Nyale Festival, derived from a story of Putri Mandalika. The main practitioner of Bau Nyale and oral tradition of Putri Mandalika is the Sasak, who have their own lunar calendar system. The date of Nyale appearance is fixed as "20th October" in Sasak calendar, then other dates are corrected by the date of "20th October". The dates around "1st January" in Sasak calendar is believed to be an ideal period for rice planting. Because rice cultivation has been the main subsistence of the Sasak, Nyale foraging has cultural and ecological significance for daily life in Lombok.

This study analyses the systematic relation between Nyale foraging and other cultural issues, in order to reveal the rationality of indigenous practices in Lombok. In addition, by describing Bau Nyale Festival as a tourism resource from different angle, sustainability of indigenous practices is discussed.

**Keywords**

*Keywords:* Lombok; Sasak; Nyale; Calendar system; Ecological Anthropology

---

**1. Calendar system and anthropology**

From the beginning of Anthropology, calendar systems have been one of important subjects for revealing cultural diversity and universality [e.g. Tylor 1859].

---

\* Corresponding author. Tel.: +81-43-290-2298; fax: +81-43-290-2298.  
E-mail address: odani@faculty.chiba-u.jp

Although almost all people in the world realize and accept western calendar system (precisely Gregorian calendar system) at present, local societies still use their local calendar system also in combination with their own cultural contexts. At present, coexistence of calendar systems is not only Anthropological issue but also social and political issue. For example, Northern European countries are relatively tolerant to receive refugees from Middle eastern countries, then refugees following Islamic calendar system practice Ramadan with difficulty under the condition that hours of daylight are too long in summer of Northern European countries [The Local 2015].

Originally, a calendar system of a local society has been referenced the local environment: astrological phenomenon, fluctuation of temperature and precipitation, biological phenomenon and so on. The need of agricultural practices is discussed as the primary factor of the invention of local calendar system [e.g. Steward 1949]. It is no wonder that the fluctuation of biological phenomenon should effect on agricultural practices. Moreover, astrological phenomenon and climate fluctuation also effect agricultural practices directly, or are used as indicators of biological phenomenon. Classical ecological anthropology has been eager to describe the relation between seasonal or annual cycle of agriculture (e.g. Rappaport 1968). However, recent studies tend to be indifference to the relation between local environments and calendar systems.

In this study we aim to describe the relation between Nyale Foraging and the Sasak Calendar System in Lombok as a case study. The Sasak, who are the majority of Lombok in Indonesia, annually forage Nyale, a kind of annelid worms. Because Nyale worms spawn regularly every one year, the regularity can be used to correct their calendar. By describing details of biological phenomenon of Nyale spawning, foraging practices and their calendar system, we will discuss flexibility of local calendar system. Problems of Ramadan above mentioned are caused by high mobility in modern global world. However, global world still consists of a lot of local societies, and mobile people also rely on some sort of local bases. Problems will never be solved without understanding the way of construction of local contexts.

## **2. Lombok Island in Indonesia**

Lombok is an island in West Nusa Tenggara province, Indonesia. Between Lombok and Bali island, the Lombok strait lies, which is one of the landmark of Wallace's Line. Wallace's Line is a biogeographical boundary separating Austrasia ecozone (characterized by marsupial's habitat) and Indomalaya ecozone (characterized by placental mammal's habitat). Although mammals of Lombok island should be only marsupials originally, by artificial introduction of buffalo, deer or monkeys there are placental mammals at present.

The capital of West Nusa Tenggara and largest city in Lombok is Mataram. The climate features measured in Mataram are showed in Figure 1 and Figure 2. Seasonal temperature change is slight, while seasonal precipitation change is relatively remarkable. Under an influence of monsoon, precipitation decreases in dry season from April to September, and precipitation increases in wet season from October to March.

Number of population of Lombok Island was 3,394,280 at 2015 [Integrated Processing and Statistics Dissemination Division 2016: p.95]. The majority of Lombok is the Sasak. Number of the Sasak at 2010 was 2,838,239 [Ananta, Arifin and Hasbullah 2015: 299], that is, over 80% of Lombok population is occupied by the Sasak. With regard to other ethnic group, the Balinese inhabit around 10-15%, and the small remainder (the Javanese, the Peranakan or the Sumbawanese) also inhabit. Most of the Sasak are Muslim, so that they use Islamic Calendar combined with Western (Gregorian) calendar in their daily life. However, the Sasak have their own calendar system, so called Sasak calendar, which is used especially for ritual dating.

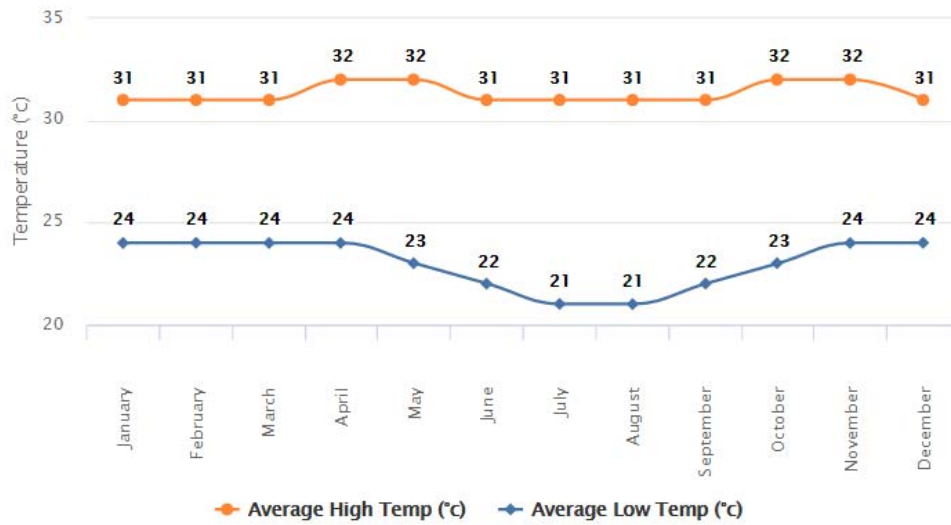

Figure 1. Temperature change in Mataram on average from 2000 to 2012. (The data are referred following website [World Weather Online 2016]: <http://www.worldweatheronline.com/mataram-weather-averages/west-nusa-tenggara/id.aspx>)

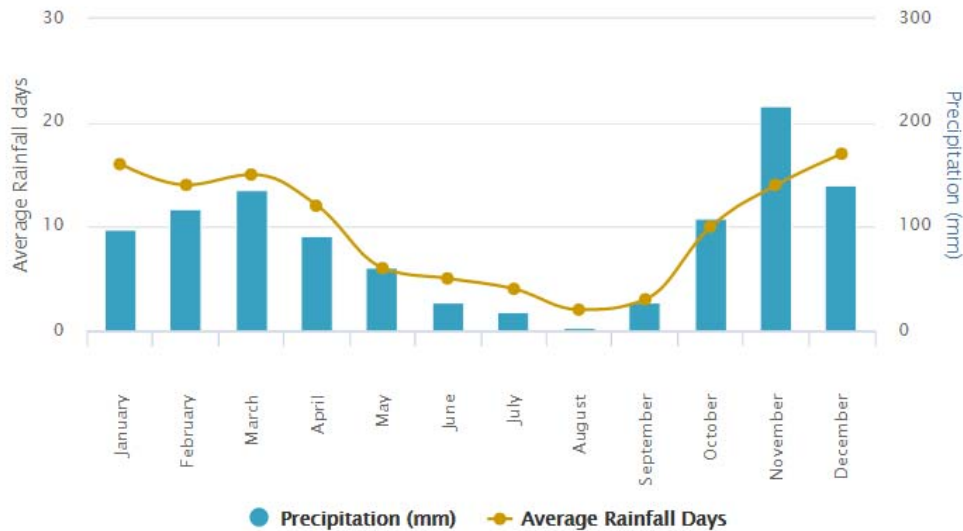

Figure 2. Precipitation change in Mataram on average from 2000 to 2012. (The data are referred following website [World Weather Online 2016]: <http://www.worldweatheronline.com/mataram-weather-averages/west-nusa-tenggara/id.aspx>)

Majority of Lombok engage in primary industry including agriculture, forestry, hunting and fisheries (table 1). The main crop in agriculture is paddy rice (Wetland and Dryland total): 1,005,822 tons per year at 2014 (The data are referred from Table 5.1.2 of *Nusa Tenggara Barat Province in Figures 2016* p.212). Judging from these data, main subsistence of the Sasak is paddy rice cropping.

Table 1. Number of workers in Lombok Island.

Number of Persons	Agriculture, Forestry, Hunting, and Fisheries	Mining and Quarrying	Manufacturing Industry	Electricity, Gas, and Water	Construction	Wholesale Trade, Retail Trade, Restaurant	Transportation, Warehousing, and Communication	Financial, Insurance, Real Estate, and Business	Community, Social, and Personal Services	Total
	829,993	34,544	199,542	3,191	156,641	459,137	69,790	24,356	350,309	2,127,503

(The data are referred and modified from Table 3.2.5 of *Nusa Tenggara Barat Province in Figures 2016* p.112)

Nyale foraging is observed at some parts of the southern coast of Lombok, mainly at Pantai Seger, Pantai Kuta, Pantai Selong Belanak, Pantai Tanjung Aan or Pantai Batu Kijuk. Pantai Seger is believed the best point for catching Nyale, and the main spot relating the legend of Putri Mandalika mentioned later locates their also. Observation of this study was conducted mainly at Pantai Seger (Figure 3). The stages of Bau Nyale festival (celebrating Nyale foraging and Putri Mandalika) stand around main foraging spots. The biggest stage stands on Pantai Kuta.

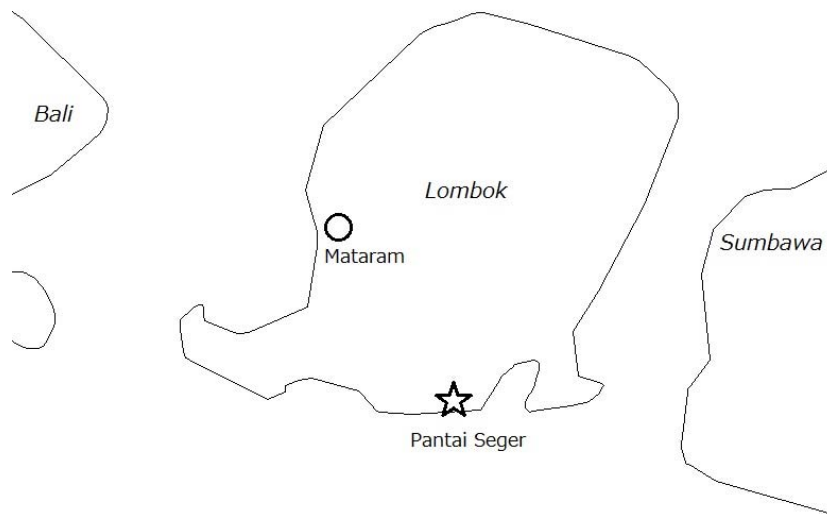

Figure 3. Location of Pantai Seger.

### 3. Nyale

Nyale is assumed to be a kind of annelid worms of the family Eunicidae. Same customs of foraging worms of Eunicidae as an attractive food resource are observed other Islands in Pacific Ocean. Foraging Palolo worm in Samoa, Fiji, or Vanuatu Islands have been most well studied [Caspers 1984, Miller and Pen 1959, Mondragón 2004], which is identified as *Palola viridis* or *Eunice viridis*. In Samoa, Palolo worm's mass spawning is observed at spring tide from October to November. The worm cut off and release their posterior parts fulfilled with sperm or eggs. Some populations in Samoa, Vanuatu, Fiji or other Islands in Pacific Ocean forage and eat the reproductive portion of the palolo worms.

Because the custom of eating the eunicid worms is observed in geographically contiguous areas from Lombok island to eastern islands reaching to Samoa, it is reasonable to classify Nyale into *Palola viridis*. However, it is also possible to assume that Nyale belongs to some different species. At first, the spawning and foraging period

of Palolo in Southern Pacific Islands is from October to November, while the period of Nyale is from February to March. At second, we observed two types of Nyale, that people consumed or traded in markets. One type has green or brown skin without chaetae (bristles) (see Picture 1), on the other hand, another type has red or orange skin with chaetae (see Picture 2.). The green and brown type is same shape that former studies reported, so that it is reasonable to classify this type into *Palola viridis*. However, because another type is assumed to be other species, biological survey to identify the species of Nyale is needed yet.



Picture 1.



Picture 2.

In Lombok, a festival so called Bau Nyale is hold simultaneously with Nyale foraging between February and March. Although it is still needed to study biologically whether Nyale spawning can be observed only once between February and March or plural times in a year, The Sasak focus on the time between February and March. Nyale foraging and this festival is used for correcting their calendar mentioned later. Such practice correcting calendar by Palolo spawning was observed in other population in Pacific Islands [e.g. Mondragón 2004].

#### 4. Nyale foraging

In 2016, Nyale foraging started from 27<sup>th</sup> February at Pantai Seger. From around 20<sup>th</sup> February, some people started to searching Nyale, and stalls for Bau Nyale festival were preparing. However, because most people think Nyale would appear after several days after full moon (i.e. spring tide) of February and Full moon was 21<sup>th</sup> February in 2016, Nyale appearance was predicted around 25<sup>th</sup> February. Some rumor was heard that professional fishermen had caught Nyale in offshore on dawn of 26<sup>th</sup>. Thousands of people crowded to Pantai Seger or other foraging spots from evening of 26<sup>th</sup>.

The mass spawning of Nyale was observed from 3:00 o'clock on 27<sup>th</sup>. People chatted, looked around stalls or fell asleep for waiting, then as soon as Nyale appearance they entered shallow to catch Nyale simultaneously. They used a kind of net called "Solok" to catch Nyale: some could catch about 1kg of Nyale, or some could not catch any. Until sunrise, people continued catching.

Already on 27<sup>th</sup> morning, selling of Nyale started in local markets. Nyale in good condition, which contained only Nyale's body, were sold about 15,000 IDR / 100g (about 120 Japanese Yen). The one in bad condition, which contained seaweeds or other rubbish, were sold about 3,000 IDR / 100g (about 25 Japanese Yen). People said that the one in good condition was caught by professional fishermen in offshore and the one in bad condition was caught by nonprofessionals in seashore.

Because our research ended 29<sup>th</sup> February, we could not observe the duration of Nyale spawning. However, people think Nyale spawning continues about one month. The idioms in Sasak language, Nyale Poto, Nylae Tanga and Nyale Punutuk, represent

Nyale spawning timing and duration. Nyale Poto, which means first Nyale Spawning, is thought to occur a full moon of late February. Nyale Tanga, which means middle Nyale Spawning, is thought to occur around the next spring tide (that is next new moon). Nyale Punutuk, which means last Nyale Spawning, is thought to occur the next spring tide (That is next full moon). People said the amount of Nyale capture was the most in Nyale Poto, in Nylae Tanga slightly declined, and after Nyale Punutuk there were no Nyale observed.

People prefer to eat raw Nyale, when it is in good condition. Stale one or the one in bad condition is cooked to “Pepes”, in which grained Nyale is mixed with spices and roasted in Banana or other large leaf. People believe that consuming Nyale guarantees their health in one year.

## **5. Bau Nyale festival and Putri Mandalika**

Bau Nyale festival is hold around Nyale Poto period, that is from late February to early March. In 2016, the period was from 22th to 29th February. Traditionally, the festival was a ritual practice of private sector. However, at present, public sector participates to hold the festival then the festival is not only a ritual practice but also tourist attractions. The ministry of Tourism and Culture of West Nusa Tenggara province organizes many kinds of events and decides dates of events. The events were as follows: social meeting, beauty contest to name Miss Putri Mandalika, stick fight contest, Wayang shadow playing, musical performance on stage and so on. Main audience of these events are assumed to the Sasak people, however, not a few foreign tourists also visit to see events.

The ritual aspect of Bau Nyale was formed by the legend of Putri Mandalika. The story is as follows. Once upon a time, the king of Lombok had a beautiful daughter named Putri (princess) Mandalika. Because of her beauty, many men including some princes asked to marry. To prevent all of them to be disappointed, she could not decide and reply. Then, the king held an archery competition at the Seger beach to decide ideal husband. However, there was no winner, because all participants had same ability and equipment. Then the participants started to argue and resulted in fighting. Soldiers following princes also started to fight, so that war came to near breaking out. Putri Mandalika did not want war and hurt many people. Then, she said that “I do not want to be one’s wife. I don't want to hurt many people. I will change to something that everybody can satisfy. I will change to Nyale that all of you can share and enjoy”. She jumped to the sea and disappeared. After that, suddenly a lot of sea worms appeared on the beach. People realized that she had changed to sea worms.

## **6. Correction of Calendar**

The Sasak fix the date of starting Nyale Poto on “20<sup>th</sup> October” in Sasak calendar. Because of Sasak calendar is lunar calendar system, length of one year would be shorter than 365 days without intercalation. Other lunar calendar systems in the world adopt various ways of correction. For example, Islamic calendar never insert intercalation and leaves the one year cycle faster than solar calendar systems. Chinese calendar system insert intercalation and fix the last new moon before “yushui”, that is 29.5 days before vernal equinox, on the new year day in order to adjust one year to be 365days. The custom of the Sasak that fixes the date of starting Nyale Poto has the same function to adjust lunar calendar system to the period of revolution of the earth.

Table 2 shows the date of the first appearance of Nyale from 2000 to 2014, which surveyed at Pantai Kuta by preceding study (Igarashi 2014). From this data, we can see regular appearance once a year. Palolo worms take the opportunity of the biggest sea

level change at the spring tide near to autumnal equinox, in order to diffuse their fertilized eggs to broader space [Caspers 1984]. Nyale is also assumed to have same behavior, although the period of spawning at the spring tide near to vernal equinox oppositely. Equinox is the phenomenon caused by revolution of the earth, and spring tide is the phenomenon caused by revolution of the earth of moon. Using the date of Nyale appearance to adjust lunar calendar system to the solar cycle is one of ideal way of correction of calendar.

Table 2. The date of the first appearance of Nyale.

Year	Date
2000	24 Feb.
2001	13 Feb.
2002	3 Feb.
2003	21 Feb.
2004	10 Feb.
2005	28 Feb.
2006	17 Feb.
2007	7 Feb.
2008	26 Feb.
2009	15 Feb.
2010	4 Feb.
2011	25 Jan.
2012	12 Feb.
2013	1 Jan.
2014	19 Feb.

The new year day in Sasak calendar is around from middle April to early may in Western calendar, which is 70days after the date of starting Nyale Poto (“20<sup>th</sup> October”). Around new year day it is the end of wet season and the start of dry season. People think that this period is ideal to rice planting. Even at present, main subsistence of the Sasak is paddy rice cultivation. It is reasonable for the Sasak or other Lombok people to correct calendar by Nyale appearance and adjust the new year day to the ideal date for rice planting.

## 7. Globalization and local calendar system

Former studies of ecological anthropology discussed that calendar systems of local society have been referred the local environment and the need of agricultural practices are the primary factors of organizing of local calendar systems. This study has verified these discussions by describing the case of the Sasak’s practices. They enjoy and profit by Nyale foraging, and at the same time they correct their calendar for paddy rice cultivation. Although consuming and cerebrating Nyale seem to be strange from outsider, they are reasonable in local ecological and social system.

At present, Bau Nyale festival is not only a ritual practice but also tourist attractions, in which foreign tourists participate too. The legend of Putri Mandalika is relatively well-known to tourists, because the story is quite impressive and beauty contest to name



Miss Putri Mandalika is held in the festival. However, logical aspect of Nyale foraging and Bau Nyale festival also should be highlighted more. The foreigner can understand the implication of “strange” customs in the context of the Sasak culture and their environment. Moreover, the Sasak also can revalue their own custom in scientific context.

Indigenous practices would be vulnerable in global world, if people felt “strange” or “primitive”. Otherwise, the practices would be treated troublesome conventions by outsider. Local calendar systems and relating ritual practices are one of the typical subject about this issue. Some calendar systems have disappeared without logical analysis in local cultural or environment context. Contradiction between migrant’s calendar system and local environment of a foreign country causes some problems. In order to keep indigenous practices sustainable, scientific studies for logical explanation in local context are needed. Moreover, when these practices attract tourists as one of cultural resources, logical explanation will enhance the value of resource.

## Acknowledgements

This study was financially supported by KAKENHI Grant-in-Aid for Challenging Exploratory Research, entitled "Integrated Area Study on Sea Worms as Traditional Cuisine in Asia Pacific" (FY 2015-15: PI = Takuro Furusawa).

## References

- Ananta, Aris., E.N. Arifin, M.S. Hasbullah. (2015). *Demography of Indonesia's Ethnicity*, Institute of Southeast Asian Studies, Singapore.
- Caspers, H. (1984). Spawning periodicity and habitat of the palolo worm *Eunice viridis* (Polychaeta: Eunicidae) in the Samoan Islands, *Marine Biology* 79 (3), pp. 229–236.
- Igarashi, Tadataka. (2014). Palolo, Celestial Body, and Indigenous Calendars, *Interdisciplinary Workshop on Traditional Calendars and Old Astronomical Records in Asia*, on 25th July 2014, The Kyoto University Museum, Kyoto.
- Integrated Processing and Statistics Dissemination Division. (2016). *Nusa Tenggara Barat Province in Figures 2016*, Integrated Processing and Statistics Dissemination Division, Jakarta.
- Miller, C.D. and F. Pen. (1959). Composition and Nutritive Value of Palolo (*Palola siciliensis* Grube), 191-194 *Pacific Science* 13 (2), pp.191-194.
- Mondragón, C. (2004). Of Winds, Worms and Mana: The Traditional Calendar of the Torres Islands, Vanuatu, *Oceania* 74 (4), pp.289–308.
- Rappaport, R.A. (1968). *Pigs for the Ancestors: Ritual in the Ecology of a New Guinea People*, Yale University Press, New Haven.
- Steward, J. H. (1949). Cultural Causality and Law: A Trial Formulation of the Development of Early Civilizations, *American Anthropologist*, 51 (1), pp. 1-27.
- The Local. (2015). New Ramadan Rules to Help Nordic Muslims in Midnight Sun, <https://www.thelocal.se/20150612/new-ramadan-rules-to-help-nordic-muslims-in-midnight-sun> Last Accessed 24 October 2016.
- Tylor, E. B. (1859). *Anahuac; or, Mexico and the Mexicans: Ancient and Modern*, Longman, Green, Longman and Roberts, London.
- World Weather Online. (2016). <http://www.worldweatheronline.com/mataram-weather-averages/west-nusa-tenggara/id.aspx> Last Accessed 24 October 2016.

**Topic :** Sosio-Humaniora

**A Preliminary Study on the Experience of Indonesian Certified  
*Kaigofukushishi*/Candidate Who Work at Japanese Nursing  
Home in Japan: A Result from Participant Observatory**

**Nazalia Kurnia Dewi**

*Chiba University, 1-33 Yayoicho, Inage Ward, Chiba, Chiba Prefecture 263-8522 Japan*

---

**Abstract**

Indonesia and Japan signed Economic Partnership Agreement (EPA) in 2007. One of the agreement is to send Indonesian nurses to work as *kanggo-shi* (nurse) in hospital and as *kaigo fukush-ishi* (caregiver) in nursing home in Japan. In this paper I will try to explain the experiences of Indonesian nurses who work as caregiver in Japanese nursing home based on my preliminary study using method participant observatory in Japan. I will write three important points in order to give a balance accounts. Once delivered to the nursing home most of them found themselves really shocked with the contents of their new work. Because they are not allowed to perform any medical actions but to assist only on daily live of residents. Second is the communication issue. Although making communication with the resident using Japanese is a hard task, they found another way to communicate with the residents, that is with *sabar* (patient) and *bercanda* (make jokes). The last one is even they felt let down with the work of caregiver after work and learn about *kaigo* (care), they have diverse opinions toward *kaigo*. Some of them say that *kaigo* is a new knowledge for them that can be implemented in Indonesia once they return.

Key words: Indonesia-Japan EPA, Indonesian caregiver/*kaigo fukush-ishi*, *Kaigo*, Nursing Home, Care

---

**1. Introduction**

Japan and Indonesia signed Economic Partnership Agreement (EPA) in 2007. One of the agreement is to accept Indonesian nurses to work as nurses (*kanggo-shi*) in Japanese hospital and as caregiver (*kaigo fukush-ishi*) in Japanese nursing home. This accepting began in 2008. However they must passed the National Board Examination (*Kokka Shiken*) to become registered nurse and caregiver in Japan. Before they passed the National Board Examination they treated as candidate (*kouhosha*), and work as well as study at the hospital and nursing home.

In this study I will focus only to Indonesian nurses who work as caregiver in Japan. I will try to describe some of their experiences while working in Japanese nursing home.

All Indonesian nurses sent to Japan all have background as registered nurse in Indonesia. However, nurses who chose the path of caregiver, in Japan they no longer a “nurse” and their work place is not in the hospital but in a nursing home. Their job is no longer doing some medical actions but to fulfill non-medical daily needs of the residents. This changing identity can bring some unpleasant experiences for them. Communication also becomes an important issue in a work that requires a lot of contact with other people such as caring work. With exist difference in language they might also experience some problems in communicating with residents they care about. How they deal with this communication barrier is important to us to know. However it should be noted that unwanted experience could turn to be a good experience if we change our way of thinking. And this is occurred to both of Indonesian nurses that I would describe their experiences in this journal.

Therefore the aim of this study is to making description about the experiences of Indonesian nurses who work as caregiver in nursing home in Japan. To describe their experiences is necessary in order to know how they exactly feel about their work and life. And further to show that although at the first they suffered disappointment but by changing their perspective about *kaigo* (care), the experiences they gained in Japan can make positive contribution toward their futures.

## **2. Methodology**

This article was based from interview and participant observatory conducted from February to April 2016 at Himawari (pseudonym) nursing home in eastern Japan. I worked as part timer with them and lived with one of the seven Indonesian nurses who work in this nursing home. I did the same work with them from feeding to bathing, but I did not making records or transfer the residents. The interview was conducted during their holiday from one to two hours.

The total number of Indonesian nurses working in this nursing home was seven, four female and there male. Their ages ranges between 25 to 34. Their educational background is D3 (three year vocational nurse), and one of the nurse had an experience working as an emergency nurse for five years in Jakarta. And only one of the nurse is married. Although in EPA scheme Indonesian nurses who work at the nursing home have not passed the national examination is called caregiver candidate (*kaigo fukushi-shi kouhoshu*), and who already passed called certified caregiver (*kaigo fukushi-shi*), in this study I will refer them as “Indonesian nurses”. From the participant observatory and in-depth interview of seven Indonesian nurses, I select two interviews, Sari and Tomi (both are pseudonym).

## **3. Introducing Sari and Tomi**

I will introduce the experience of Sari and Tomi. Sari is a 27 years old female nurse from East Java. After graduated from the nurse school she applied as caregiver to EPA program. She was motivated by the fact that salary of caregiver in Japan is high compares to nurse salary in Indonesia. However economical reason is not the only reason for Sari to apply to EPA program. She says that she wanted to learn about Japanese nursing. She is arrived in Japan in 2011 and already passed the Caregiver National Board Examination. However she decided to return to Indonesia. The next nurse is Tomi. He is a male nurse from West Java and born in a nurse family. He is 31 years old. Tired of being an emergency nurse in Jakarta, he decided to apply to EPA program. Instead of choosing nurse path he chose to enter caregiver path. He is arrived in Japan in 2014, and now working as caregiver candidate and also study to prepare for the Caregiver National Board Examination.

#### 4. Daily Works at Himawari Nursing Home

There are four shifts in this nursing home. Morning shift from 7 AM to 15.30 PM, day shift from 9 AM to 17.30 PM, late shift from 11 AM to 19 PM, and night shift from 16.30 AM to the next day 10 AM. Below is an example of Himawari nursing home's daily routine for the day shift.

09:00-09.10	Morning briefing
09-10-10:00	Toileting assistance, changing diapers, return used diapers to collecting area writing records
10:00-12:00	Bathing (only certain day)
10:00-10:30	Prepare for noon tea and liquid diet (some residents consume a liquid diet)
10:30-11.30	Transfer the residents to the hall, feeding the residents with liquid diet, serving noon tea, lunch preparation
11:45-12.30	Serving lunch, feeding residents who need assistance, collecting eating utensil and return it to the kitchen, writing records (make record about how much the residents eat or drink, usually only percentage)
12:30-12:45	Toileting assistance
12:45-13.45	Lunch break
13:45-14:30	Changing diapers and return it to collecting area
14.00-16.30	Bathing (only certain day)
15:00-15.30	Preparation for snack and afternoon tea
15:30-16.00	Fold the resident's clothes and return it to their rooms
17.00-17.30	Preparation for tea and dinner

However depend on the actual situation, there are some cases causing delay in the daily routine.

#### 5. Sari and Tomi's Experiences in Himawari Nursing Home

I will describe some experiences of Sari and Tomi when they entered a Japanese nursing home. About how they felt when they found the truth about their job, how they deal with residents, and about how they gain a new positive perspective about their work.

##### 5.1 Imagination vs Reality

In the previous study, there are two main reason why Indonesian nurses working in Japan. First is to get higher salary and second to obtain knowledge about nursing in Japan (Hirano and Wulansari, 2009). As I pointed above, the main reason for Sari to come to Japan is to get high salary and learn about nursing in Japan. However, Sari as well as other Indonesian nurses who work in this nursing home admitted that they do not have a clear picture of what is *kaigo* and what is the content of their work. It is true that before they leave for Japan there was a an explanation about the work content of caregiver such as feeding and taking the residents for a walk. They argued that the other part of work such as lifting and transfer the residents, changing diapers, and cleaning job was absent from the explanation. They are also forbidden to perform any kind of medical actions. Hence they were surprised by the content of their work when they delivered to nursing home.

"First time I came to this nursing home I was shocked by the content of the work. The daily activities do not content the medical elements. I felt my character as nurse was killed. I think we all Indonesian nurses sent to Japan to work as caregiver feel the same way" (Sari)

This finding is similar to Wulansari and Alam (2010). In their study they found that Indonesian nurses who work at the hospital in Japan feel disappointed because they only allowed to perform non-medical care before passing the National Board Examination.

Before came to Japan, Sari worked several months as nurse at hospital in East Java. As she explained, nurse's main work in Indonesia is to give an injection, infusion, and provide medicine. Therefore when she was sent to the nursing home and knowing that her work was limited to the fulfillment of the basic humane care she felt very disappointed.

### **5.2 Sabar and Bercanda as A Way to Communicate with Residents**

Indonesian nurses sent to Japan learned Japanese language six months before going to Japan and six months after arrived in Japan. However for some nurses, the Japanese language is still an obstacle in their daily works. They have trouble in communicating with the residents. For example, some who sent to rural areas have difficulty to understanding the local dialect (*hougen*), which is completely different with the Japanese standard they learned. And also one of the most important in their works is to write a daily care note (*kaigonisshi*). Daily care note can be a hurdle for them because they have to write it in *kanji* (chinese character). And in some nursing home daily care note is handwriting. As demonstrated above, in order to become registered caregiver they first must passed the National Board Examination. Therefore they work and study for the National Boards Examination preparation at the same time. Because they have to learn *kaigo* in Japanese, they found it difficult especially to understand technical jargon. However despite in this difficult circumstance, Tomi says that the most important way to communicate with the residents is with *sabar* and *bercanda*.

"It is hard to communicate with *orang tua* (elder people). But to build a trusting relationship with the residents who have dementia or not is to repeat the same thing everyday, we have to be patient. For example say your name everyday to them. If we do it with patient, we will have close relationship with them. You will see, that even residents who have dementia will remember you. And don't forget to *bercanda* (make jokes) with them. They need it, it's an entertainment for them" (Tomi)

Tomi, every time ofuro (bath) time comes, will be wearing pink or blue apron and tied a small towel on his head and greet "*irasshaimase*" (welcome) to all the residents who will be bathed. One day there was one resident who come to him and asking the same question all day, and he said "see, that is why we have to be patient". This kind of communication makes Tomi the most favorite caregiver in his floor. One day when Tomi did not come to work, a resident name Tachikawa (pseudonym) asked about Tomi to Sari. "Where is Tomi?" Sari replied "He is not coming today, but don't worry I will take care of you today" but then she denied her "Oh no, I prefer Tomi", and Sari was burst to laugh.

### **5.3 Kaigo as New Knowledge**

As I pointed above Sari and Tomi's background is registered nurse in Indonesia. Before came to Japan they did not have a clear picture about their work. When they found out the truth about their work they feel disappointed because what they imagined and the reality was very different. However after they learned about *kaigo* and practiced it they gained a new perspective about *kaigo*.

"*Kaigo* can certainly be applied in Indonesia by applied it directly to the society. It can be practiced in community health center or by opening a clinic on my own. I receive patients at home and explain to them how to care for older people, or how to care older people with dementia. For example if there is a dementia patient who can't move his

legs, I can do rehabilitation. Doesn't mean that *kaigo* have to be applied only in nursing home, but we can apply directly in the society" (Tomi)

"I realized that nursing is not always something about medical or pharmacological. In Japan the nursing technology is very improved but there is also rehabilitation. What I think the most important thing that I learned in here is called *rengkei* (cooperation). The hospital cooperated with the rehabilitation center to get the patients recovered from his/her illness. Its very different with Indonesia. I want to bring *kaigo* to Indonesia when I return someday. I want to practice it for my family or for people in my village. Or if I can for the people in Indonesia" (Sari)

Sari and Tomi realized that *kaigo* is a knowledge that can be applied in Indonesia. Working in Japanese nursing home benefit them in how they planning for the future. *Kaigo* is a manifestation of their future when decided to return to Indonesia. Not only for them, *kaigo* that brought to Indonesia by Sari and Tomi is a benefit also for the people around them. They can become agents of change in society about how to understand and care for the elder people.

## 6. Conclusion

I have described the work experiences of Sari and Tomi. As we can see from above description, there is a positive change of Sari and Tomi's point of view for *kaigo*. When they first being sent to Himawari nursing home, due to the lack of information concerning *kaigo* and caregiver's main work, they felt disappointment. However after they learned and practiced *kaigo* in their daily work, they found *kaigo* as a new knowledge and can be practiced in their society. Experiences and knowledge they gained in Japan help them to plan for their future. In this study also we can see that the Japanese language still a hurdle for Indonesian nurses to prepare for their National Board Examination. However in practice in their daily works at the nursing home, the Japanese language is not a barrier in communicating with the residents. In fact, Tomi found a way to communicate with the residents. That is with *sabar* and *bercanda*. This way of communicating makes him the most wanted caregiver in his floor.

*Kaigo* is a new notion for Indonesian nurses. Aging society and *kaigo houken* (long-term care insurance) are two things that distinguish between Indonesia and Japan society. And the impact of the differences is felt directly by Sari and Tomi who work in nursing home in Japan. I believe that the experiences of Indonesian nurses, who work in Japan, like Sari and Tomi's experiences, could give a positive influence for the Indonesian society in the future.

## Acknowledgement

The author wish to express her gratitude to all Indonesian nurses who participated in this study. Thank you for the trust and allowed me to stepped in into your lives and share all the stories. I would like to express gratitude also to all the staff in Himawari nursing home. Thank you to let me in and helped me learn about *kaigo*.

## References

- Bachtiar, Alam and Wulansari, Sri Ayu. (2010). Creative Friction: Some Preliminary Considerations on the Socio-Cultural Issues Encountered by Indonesian Nurses in Japan. In *Bulletin of Kyushu University Asia Center*, Vol 5, pp. 183-192
- Hirano, Yuko Ohara and Wulansari, Sri Ayu. (2009). The Japan-Indonesia Economic Partnership Agreement Through the Eyes of Indonesian Applicants: A Survey and a Focus Group Discussion with Indonesian Nurses. In *Bulletin of Kyushu University Asia Center*, Vol 3, pp. 77-90



**Topic :** Socioeconomics Relations

**The Response Of Public In Palangka Raya To Bank Muamalat  
Indonesia (BMI) Palangka Raya Branch**

Ali Sadikin, SE, MS11

*Head of Magister on Islamic Economics, Graduate Program, State Islamic Institute (IAIN)  
of Palangka Raya, Jl. G. Obos Komplek Islamic Center No. 24, Palangka Raya 73112,  
Indonesia*

---

**Abstract**

The main concepts on Islamic banking are the principle of justice and not charge interest system. Through the prohibition of interest in Islam so that Islamic economics experts in agreement that re-organization of Islamic banking should be implemented based on partnerships (*shirkah*) and profit sharing (*mudarabah*). In other review, the characterized of socio-cultural conditions as well as religious of public in Palangka Raya those are the number of Muslim as majority and the level of religious life (based on researcher observations), those things assumed have an influence to public response on factors of product, service, socialization, benefit and social setting.

Author collects data used questionnaires and interview methods, to analyze the public response and public perception to the existence of Bank Muamalat Indonesia. The aims of this research are (1) to find the public response to the existence of Bank Muamalat; (2) to find and analyze the public response toward Bank Muamalat Indonesia used scoring method to the questionnaire.

Based on the result of this research discovered that for the most part of public of Palangka Raya (respondents) accept and respond positively to the existence of Bank Muamalat Indonesia (BMI) Palangka Raya Branch. At the aspects of product, service, benefit and setting social are in accordance as expected (adequate). While, public response (respondents) at the aspect of socialization is still less and needs to be improved

**Keywords**

Public Response, Bank Muamalat Indonesia

---



# **The Response Of Public In Palangka Raya To Bank Muamalat Indonesia (BMI) Palangka Raya Branch**

## **1. Background**

Islamic economics development in accordance with the progress of Islamic financial institutions as the prime mover of financial institution. As one of the highest Moslem citizens in the world, it was quite unfortunate that Islamic financial institutions newly flourished in the late 1990s, after recommendation of Majelis Ulama Indonesia (Indonesian Council of Ulama) was released in the workshop on bank interest on 18-20 August 1990. Indonesia was left behind compared to Middle East countries, even from Malaysia.

At the era of 1940s, the concept of Islamic bank had emerged. Banking system in Islamic economics based on profit and loss sharing concept. The general principle is anyone who want to earn the outcome from savings, should be willing to take risks, the bank will also share the company's losses if they want the outcome of their capital gains.<sup>2</sup> Mit Ghamr Lokal Saving Bank was the first modern Islamic bank in Mesir. In Manila also established Philipine Amanah Bank in 1973 and Dubai Islamic Bank in 1975, placed in Dubai.<sup>3</sup>

After going through a long process though a bit late, at the end of 1991, precisely on 1<sup>st</sup> November 1991 was the signing of the Deed of Establishment of PT Bank Muamalat Indonesia.<sup>4</sup> Then on 1<sup>st</sup> May 1992, Islamic financial institutions, such as Bank Muamalat Indonesia, Bank Perkreditan Rakyat Syariah and Asuransi Takaful started to operate. Along with the emergence of those Islamic financial institutions, an Islamic financial institution also established in Palangka Raya that is Bank Muamalat. Contemporary Moslem scholars have been formulated Islamic banking products, which

---

<sup>2</sup>Muhammad, 2001, Bank Syari'ah: Analisis Kekuatan, Peluang, Kelemahan dan Ancaman, Ekonosia, Kampus Fakultas Ekonomi UII, Yogyakarta.

<sup>3</sup>M. Syafi'i Antonio, Bank Islam dari Teori ke Praktek, Jakarta: Gema Insani Press, 2001, p. 18 and p. 25.

<sup>4</sup>Syamsul Anwar, Permasalahan Produk-produk Bank Syari'ah: Studi tentang Bai Muajjal (P3M, IAIN Sunan Kalijaga, 1995), p. 17.

have been adjusted to the concepts of muamalat contained in *fiqih* books by *ulama*<sup>5</sup>, sourced from Al-Qur'an and Hadith.

Characteristic of those financial institutions above, showed from the products offered that assumed be able to give sense of fairness and more Islamic. Those financial institutions have implemented their products in line with *qawaid al fiqhiyah*<sup>6</sup> so that expected will be able to meet Moslem's desire, especially to transact with no *riba* (usury) or interest which has been a polemic.

The peculiarity of Islamic bank is it used an approach which prioritize sense of justice, and forbids an interest. Through the prohibition of interest in Islam, the experts of the modern economy agree that re-organization in banking should be implemented based on partnerships (*shirkah*) and profit sharing (*mudarabah*).<sup>7</sup> Replaced an interest mechanism, some *ulama* believe that in an individual project funding, the best instrument is profit sharing.

However, as the result of a field observation, in practice it should be recognized that the transaction of muamalat activities often incompatible with the concepts of Islam, as happened in Palangka Raya. A lot of transaction practices on muamalat which incompatible with revelation. In muamalat cases, some people rarely heed the norms and ethics that regulated in Al-Qur'an and Hadith, whereas almost everyone knows the prohibition of *riba* (usury). Its indication can be viewed from the loss among community or business institutions. For example in this case is habit of public in Palangka Raya, especially around author's neighborhood who still borrowing money (debt) to the loan sharks while borrowing money to Islamic bank. Some traders prefer to borrow fund to an investor who are preparing a fund but asking for interest (usury) in a row.<sup>8</sup>

---

<sup>5</sup>*Ulama* is an expert on Islamic law. In this paper, *ulama* identified as an expert in Islamic economics who participate actively in the implementation of the concepts of Islamic values to the operational of Islamic banking, which is being developed nowadays.

<sup>6</sup>Rules of *fiqih* or the principles of Islamic law.

<sup>7</sup>Nejatullah Siddiqi, *Kemitraan Usaha dan Bagi Hasil dalam Hukum Islam*, (Jakarta: Dana Bhakti Prima Yasa, 1992), p. 1.

<sup>8</sup>Based on author's observation to people who involved debts with loan sharks style.

Actually, it is a reality that Moslem community in Palangka Raya obey the rules of Islam in field of ibadah (worship/*ibadah mahdah*), But unfortunately *Tuan Guru* (ulama in Palangka Raya) seem do not change too much on religious life of Moslems in *muamalat* aspect.

In the context of mutual benefit in business, Bank Muamalat exists to serve the community, especially in Palangka Raya as well as Central Kalimantan. In one side, product of Bank Muamalat is needed by people to be business partners and develop business. But in another side, operational of Bank Muamalat still experiences many obstacles to implement its products. This case caused not only by material regulations (its substance) in form a concept of its products, but also influenced by external factor that is behaviour of stakeholders of muamalat in general. These things greatly affects the response of public in Palangka Raya to Bank Muamalat Indonesia (BMI) Palangka Raya Branch.

## **2. Literature Review**

The research by Ashanul In'am (1996) on "Performance Analysis of BMT" more oriented to "want to know or examine" the hypothesis about opportunities and obstacles faced by BMT in the economic empowerment of people through its business strategies consisting of site selection, prices and services. This research states that BMT has high opportunity to carry out its mission and empower small business.

Other research on How BMT give credit to customer with no interest system by Yustikosari (1996) oriented to credit with mudharabah system practiced by BMI without binding the customer through contractual system as customer or creditor and debtor, but both in balanced position, that is as partners. He also concluded that the existence of Bank Muamalat Indonesia is more independent than conventional bank.

This superiority, is a characteristic from Islamic bank and distinguish it from non-Islamic financial institution system. As stated by Abd. Adhim (1998) in his research on comparative between Bank Perkreditan Rakyat (BPR) with Profit Sharing system and

Bank Perkreditan Rakyat with interest system (conventional). The result of this research concludes that profit sharing system has positive double values. It means that BPR through profit sharing system not only plays its role as financial institution but also implements Islam mission that is *Amar Ma'ruf Nahi Munkar*.

In international scale, banker and Islamic economist also have done research on various aspects related to Islamic banking. Comparative study did by Abdul Gader A., and Gahrani S., on "*Islamic and Commercial Banking Role in Economic Development: A Comparative Financial Evaluation*" in 1990 that compared three Islamic banks (Bahrain Islamic Bank, Faisal Islamic Bank, in Bahrain and Dar Al mal Al Islamic with non-Islamic bank (*Nation Commercial Bank* in Saudi Arabia and Saudi American Bank). The result of this research shows that: 1) Islamic Bank tends to maintain a higher ratio between cash and deposit than non-Islamic bank; 2) Percentage of equity capital (*equity*) to total assets in Islamic bank is higher than traditional bank that operated in same region; 3) Islamic Bank shows higher profit ratio than traditional bank that operated in same country; 4) Islamic Bank is more efficient than commercial bank which proved by the ratio of non-interest expense with gross revenue (Metwally, 1995 : 149).

Anwar Iqbal Qureshi (1973 : 113) in his book "*Islam and the Theory of Interest*" explains specifically about Islam and credit. He states that Islamic banking is consistent to Islamic doctrine wisely avoids things that harm for one side, and also put capital owner and trader in same level, and combine their interests. If there is someone who has fund without experience or skill that needed to run a business, and also another one who does not has fund but skill that needed by Islamic business institution, as seen in Islamic banking practice that combines those both interests through fund from the first person and skill from the rest would be permitted because profitable if combined to business institution in order to get profit proportionally.

Anita Rahmawati, in 1999/2000 through her dissertation: Controversy on Validity Status of Murabahah in Islamic Banking: Study of Product Implementation of

BMI Semarang Branch. In this research, main theme is focused to controversy of a product of Islamic bank that is *murabahah*. This research is not too different with research by Syamsul Anwar, because the product *bai bi saman ajil* in the principle is developed from *murabahah*. But, this research has more value because this is field research which is in BMI Semarang Branch. Its difference with research by author is this does not look for the response of public (*muamalat* behavior) to the product, as well as the difference of research location.

Based on those researches above show explicitly the positive dynamics on growth rate and system of operationalization of Islamic banking. In addition, the system that has been implemented by Islamic bank and Islamic financial institutions with no interest is responded positively by public. It caused by an assumption that interest is prohibited and contains the element of exploitation.

### **3. Research Methods**

This research uses descriptive analysis method that draws and explains about the response of public in Palangka Raya to Bank Muamalat Indonesia (BMI) Palangka Raya Branch and the response of public in Palangka Raya to the factors of product, services, socialization, benefit and social setting of public of Palangka Raya in form of table and percentage.

Data of this research collected through: questionnaire, interview and documentation. Through those methods valid data would be collected that related to the problem of research.

### **4. The Results of Research**

#### **a. Response of Public to Bank Muamalat Indonesia**

Data collecting as one method of this research has done during March to April 2006. Data collecting methods that choosed are questionnaire used checklist. The questionnaire spread to respondents consists of: (1) Bank Mualamat practitioners, either management or employee, (2) customers; (3) public figure/*tuan guru (ulama)* (4)

public non-customer. For respondent who not knowing about Bank Mualamat will get an explanation, especially for non-customer respondent. The result of this research about the response of public in Palangka Raya to Bank Mualamat Indonesia (BMI) Palangka Raya Branch can be viewed on the tables below:

- a. Based on respondent knowledge

**Table 1.1. Response of Public Based On Knowledge**

<b>Opinion of Respondent</b>	<b>Frequency</b>	<b>Percentage</b>
Know	12	8 %
Just know	74	49.3%
Know little	35	23.3%
Do not know	29	19.3%
<b>Total</b>	<b>150</b>	<b>100 %</b>

*Source: Result Data of Questionnaires*

From the table 1.1. known that 12 respondents (8%) stated they know about the concept of Bank Mualamat. 74 respondents (49%) stated they just know about the concept of Bank Mualamat. Whereas 23,3% stated they know a little thing about the concept of Bank Mualamat. And 29 from 150 respondents (19,3%) stated they do not know about the concept of Bank Mualamat. From this research as the table above concludes that mostly people in Palangka Raya have little knowledge on the concept of Bank Mualamat. Based on that respondents little knowledge so that needed a proactive effort from Bank Mualamat to inform and explain to public about the concept of Bank Muamalat.

- b. Based on Source of Information

**Table 1.2. Response of Public Based On Source of Information**

<b>Respondent's Opinion</b>	<b>Frequency</b>	<b>Percentage</b>
Mass media	59	39,3%
Advertisement	0	0

Friend/relation	47	31,3%
Others	44	29,3 %
<b>Total</b>	<b>150</b>	<b>100%</b>

Source: Result Data of Questionnaires

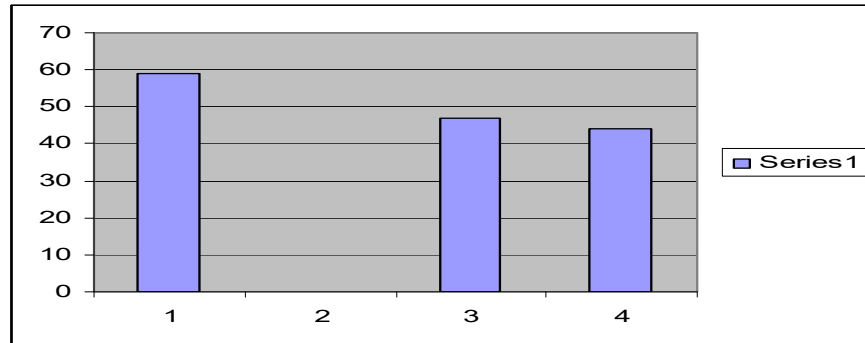

Source: Result Data of Questionnaires

Table 1.2. Response of Public Based On Source of Information

Grouping based on source of information displayed above (table 1.2.) has shown 59 respondents (39,3%) stated that they got information about Bank Muamalat from mass media. No respondent (0%) has gotten information about Bank Muamalat from advertisement. 47 respondents (31,3%) got information from friend/relation. 44 respondents (29,3 %) got information about Bank Muamalat from other media such as social gathering, associations and others.

Based on result of research about source of information that people get about Bank Muamalat Indonesia, mass media plays big role to socialize Bank Muamalat Indonesia (BMI) Palangka Raya Branch. Therefore, mass media is very effective to improve people's knowledge in Palangka Raya.

Furthermore, friend/relation and other media also play effective role to give information about Bank Muamalat. However, if explored further, people will give information about anything (including bank) if they feel satisfied from that thing. Based on those facts, so management of Bank Muamalat should prioritize customer satisfaction.

c. Based on Types of Respondent

**Table 1.3. Types of Respondent of Research**

<b>Respondent's Opinion</b>	<b>Frequency</b>	<b>Percentage</b>
<i>Bank Muamalat's Employee</i>	12	8%
<i>Customer</i>	68	45,3%
<i>Non-Customer</i>	62	41,3%
<i>Public Figure</i>	8	5,3%
<b>Total</b>	<b>150</b>	<b>100%</b>

*Source: Data from Result of the Questionnaires*

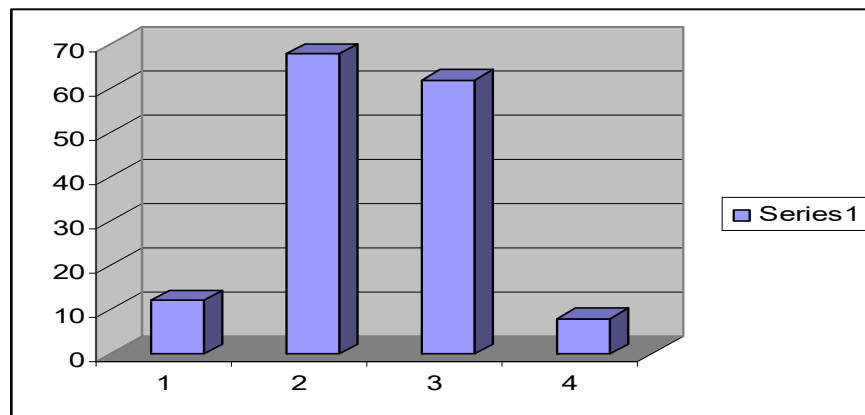

*Source: Result Data of Questionnaires*

Information above in table 1.3. shows a general description of respondent based on its types, that majority of respondents of Bank Muamalat Palangka Raya Branch are both customer (45,3%) and non-customer (41,3%). The next frequency came from employee of Bank Muamalat (8%) and public figure (5,3%). Based on types of respondent that show majority of respondents are customer and non-customer.

**b. Public Response to Product, Service, Socialization, Benefit and Social Setting**

As in the data of public response on Bank Muamalat, data of public response about (1) product; (2) service; (3) socialization; (4) benefit (5); and social setting collected through questionnaire instrument in collecting. Data collecting could be described as follows:

a. Public Response to the aspect of Product

Result data of research about public response on product of Bank Muamalat



composed to 5 categories; strongly disagree, disagree, doubtful, agree, and strongly agree. Result of research as in the table 1.4. below:

**Table 1.4. Public Response to the Aspect of Product**

<b>Respondent's Opinion</b>	<b>Frequency</b>	<b>Percentage</b>
Strongly disagree	2	1,3 %
Disagree	3	2,0 %
Doubtful	32	21,2 %
Agree	85	56,7 %
Strongly Agree	28	18,7 %
<b>Total</b>	<b>150</b>	<b>100 %</b>

*Source: Result of the Questionnaire*

Based on the result of research above, can be known that mostly respondents agree with the product of Bank Muamalat (56,7 %), followed by doubtful (21,2%), strongly agree (18,7%), disagree (2,0%) and strongly disagree (1,3%) as the last. The conclusion is mostly respondent agree with the product of Bank Muamalat. For further details can be viewed in pie chart below:

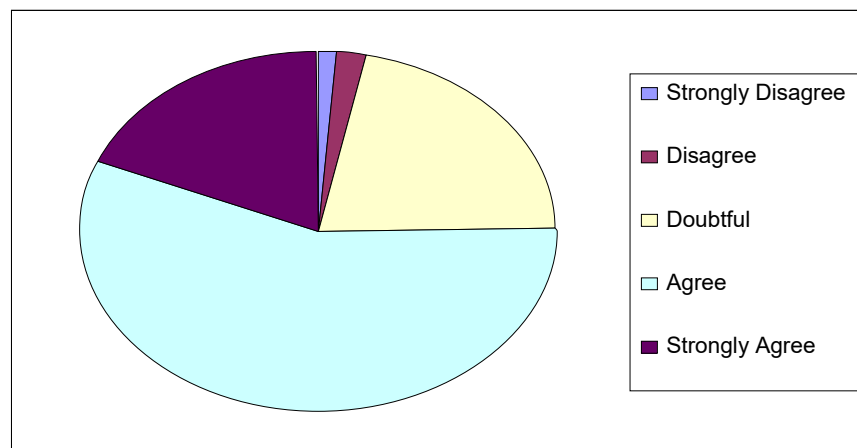

Source: Result Data of Research

b. Public Response to the aspect of Service

Result data of research on public response about service aspect of Bank Muamalat composed to 5 categories; very low, low, normal, high and very high, that can be viewed in the table 1.5. as follows:

**Table 1.5. Public Response to the Aspect of Service In Bank Mualamat**

Respondent's Opinion	Frequency	Percentage
Very low	3	2,0 %
Low	13	8,7 %
Normal	47	31,3 %
High	68	45,3 %
Very high	19	12,7 %
<b>Total</b>	<b>150</b>	<b>100 %</b>

Source: Result of the Questionnaire

Based on result data of research above, can be known that mostly respondents rate "high" for service aspect (45,3%), and the rest 31,3% rate normal, 12,7 % rate very high, 8,7% rate low and 2% rate very low for the quality of service aspect. The conclusion is mostly respondents agree with service model of Bank Muamalat as one of the factors of consideration by customer. For further details can be viewed in pie chart below:

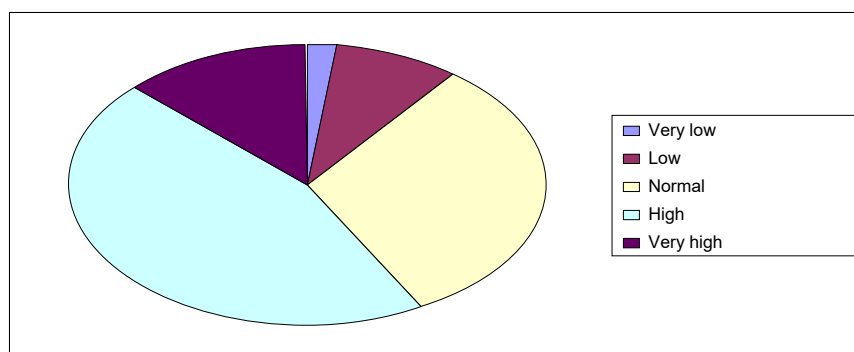

Source: Data from questionnaire

### c. Public Response to the aspect of Socialization

Socialization aspect is an important aspect to make Bank Muamalat Indonesia (BMI) known by public. Socialization aspect that has been implemented by Bank Muamalat Indonesia (BMI) Palangka Raya Branch evidently gets low rating from public in Palangka Raya. It means that product of Bank Muamalat Indonesia Palangka Raya Branch is not much known by people.

Respondent's statements to the aspect of socialization can be viewed from public awareness on Bank Muamalat Indonesia (BMI) Palangka Raya Branch. Those

statements composed in the table 1.6. below:

**Table 1.6. Public Response to the Aspect of Socialization**

<b>Respondent's Opinion</b>	<b>Frequency</b>	<b>Percentage</b>
Very low	13	8,7 %
Low	24	16 %
Average	79	52,7 %
High	34	22,6 %
Very high	0	0
<b>Total</b>	<b>150</b>	<b>100 %</b>

*Source: Result of the Questionnaire*

From the result of questionnaire in the table 1.6. above known that socialization factor is very decisive for public awareness to the concepts or products which are owned by Bank Muallamat. From the questionnaire known that socialization aspect is still less intense. 52,7% of respondents have average knowing on products of Bank Muallamat Indonesia Palangka Raya Branch, while 16% have low knowing on products of Bank Muallamat Indonesia Palangka Raya Branch.

Socialization by Bank Muallamat Indonesia has a significant value to affect the public use Bank Muallamat's services. However, based on those respondent's opinion above, socialization that has done by Bank Muallamat shows an unsatisfactory result. This socialization must always be implemented so that public in Palangka Raya who mostly are *Muslim* will know, understand and desire to use Islamic bank services at last, so the purpose of Islamic bank establishment (Bank Muallamat Indonesia) as an alternate means for Muslim to avoid interest system will be achieved. Socialization aspect of Bank Muallamat Indonesia (BMI) Palangka Raya Branch is not quite optimal as showed below:

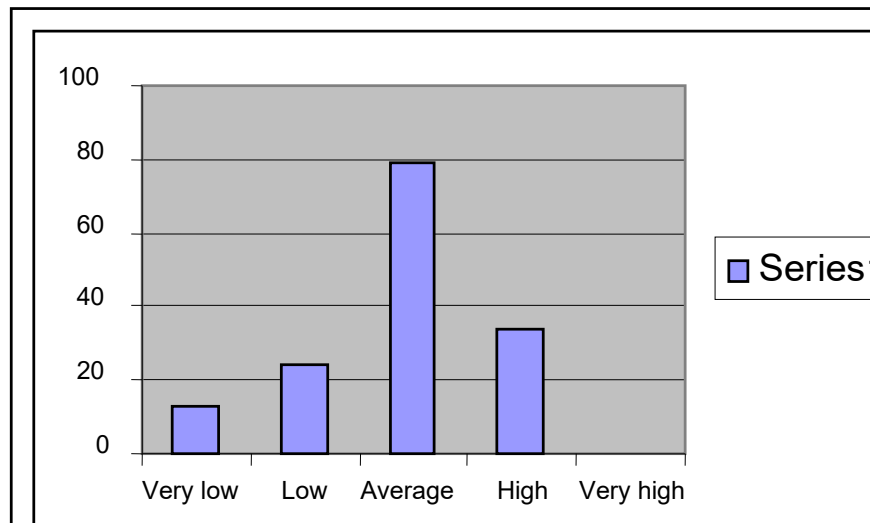

*Source: Result of the Questionnaire*

According to one customer of Bank Muamalat Indonesia who is living in Kereng Bangkirai Urban Village, Sebangau sub-district, which majority people living there are Muslim, that mostly people in his neighborhood do not know about products offered by Bank Muamalat Indonesia. Moreover, there are some people do not know that Bank Muamalat Indonesia Palangka Raya Branch is exist.<sup>9</sup> Indeed, it related to lack of effort to socialize its products, especially from Bank Muamalat Indonesia Palangka Raya Branch itself. Consequently, it is needed to socialize Bank Muamalat Indonesia Palangka Raya Branch more intensive.

d. Public Response to the aspect of Benefit

Public statement on the existence of Bank Muamalat Indonesia (BMI) Palangka Raya Branch for the most part respond positively, it means that they welcome to the existence of BMI. It can be viewed from respondent's answer on the aspect of benefits which exist in the concept of Bank Muamalat Indonesia, those are tauhid (Oneness of God), social (togetherness) and economy. In a review of aspect of the anti-usury (anti-riba), there are various opinion of respondent between agree and disagree. The answer of respondent on the aspect of benefits that exist in Bank Muamalat can be viewed in the

---

<sup>9</sup>This is further strengthened by opinion of some students who interviewed by author.

table 1.7. as follows:

**Table 1.7. Public Response to the Aspect of Benefit**

Respondent's Opinion	Frequency	Percentage
Strongly Disagree	0	0%
Disagree	22	21,3%
Doubtful	32	19,3%
Agree	66	44%
Strongly Agree	23	15,3%
Total	150	100%

*Source: Result of Questionnaire*

Based on result of the questionnaire in the table 1.7. above is known that public response to the aspect of benefit given by Bank Muamalat is quite high. 44% of respondents agree, while 21,3% disagree, and the rest are 19,3% stated doubtful and 15,3% strongly agree.

When author talk to some people of Kereng Bangkirai Urban Village in informal interview, their reason in choosing to use banking is their needed to withdraw funds, without consider which is *haram* (forbidden) or not. Indeed, in this case, the concept of *haram* (forbidden) of banking interests is very thin. People thought, if there is any bank that allow interests, why should looking for Islamic bank, especially if its location is not strategic. This thought generally used by Muslim in Palangka Raya, in addition to emergency reasons.<sup>10</sup> So that needed a proactive effort from all parties who know and understand about muamalat to explain to public. Those public opinion above can be viewed visually as follows:

---

<sup>10</sup>Author heard this thought when author did an interview. It was also opinion by some respondent who are non-customer of Bank Muamalat.

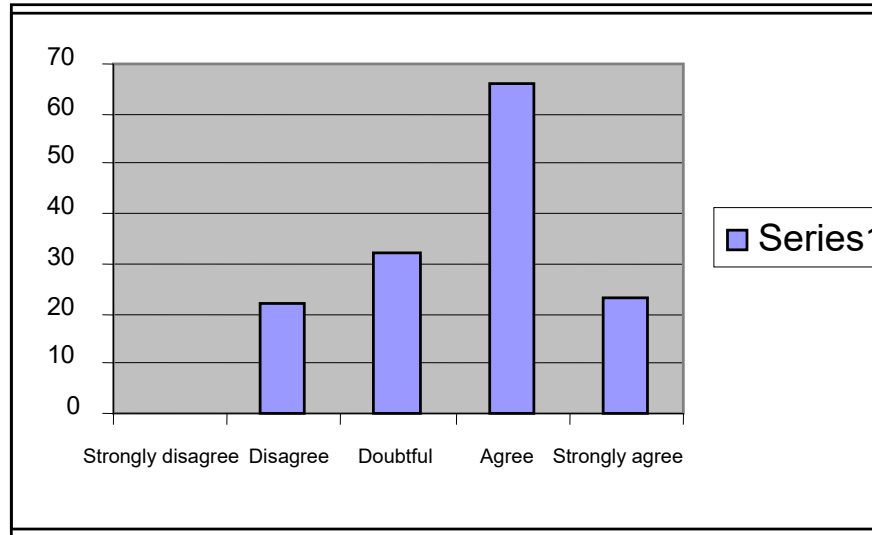

Source: Result Data of Questionnaire  
Diagram on Public Response to the Aspect of Benefit

Actually, whether interest is same with *riba* (usury) or not had been discussed by MUI (Indonesian Council of Ulama) in workshop on Bank Interests and Banking at Cisarua, Bogor on 19-22 August 1990. In that workshop, it was recognized about two opinions on bank interests, those were an opinion which believed that bank interests is *riba* (usury) and forbidden, and other opinion which assumed that bank interests is *halal* (permitted). Hereinafter, in the 4<sup>th</sup> National Conference of MUI period of 1990-1995 on September 1990 in Jakarta, both ulama (expert in Islamic law and economics) who believed that bank interests is *haram* and ulama who assumed that interest is *halal* they agreed to develop a system and procedure of banking which is non-interest. This agreement contained in The Broad Outlines of the Work Programme of Indonesian Council of Ulama 1990-1995.<sup>11</sup>

Polemic of the existence of bank interests itself become an obstacle for growth and development of Islamic bank. According to Muhammad Hasbi's opinion that Islamic bank nowadays is getting less attention by people due to the controversy of legal status of bank interests. Furthermore, and this is an expectation of Islamic

<sup>11</sup>Karnaen Perwata Atmadja, "Peluang dan Strategi Bank Tanpa Bunga dengan Sistem Bagi Hasil dalam Bisnis Perbankan di Indonesia", in Hamid Busyaib and Mursyidi Prihantoro (ed.), *Bank Tanpa Bunga* (Yogyakarta: Mitra Gama Widya, 1993), p. 1-2.

banking practitioners, government through MUI (Indonesian Council of Ulama) should unite public perception on bank interests to release *fatwa* (legal opinion or legal pronouncement) that declare bank interests is *haram* (forbidden), and people must switch to Islamic bank based on shariah as an alternative.<sup>12</sup>

e. Public Response to the aspect of Social Setting

Social setting aspect is a characteristic of people condition in Palangka Raya that may affect public response on Bank Muamalat Indonesia Palangka Raya Branch. That thing above can be viewed from the result of questionnaire contained in table 1.8. as follows:

**Table 1.8. Public Response to the Aspect of Social Setting**

Respondent's Opinion	Frequency	Percentage
Very low	9	6%
Low	39	26%
Normal	42	28%
High	55	37%
Very high	5	3%
<b>Total</b>	<b>150</b>	<b>100%</b>

Source: Result Data of Questionnaire

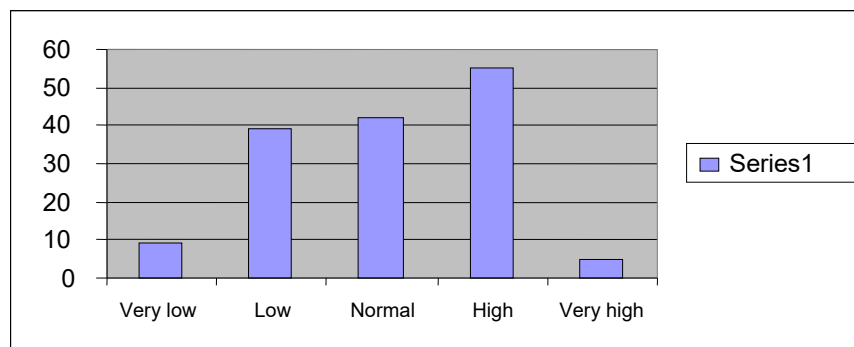

Source: Result Data of Questionnaire

As table 1.8. above can be known if mostly respondents agree that social setting

<sup>12</sup>When author interview an Islamic bank practitioner in Palangka Raya.

aspect has significant role (37% for high option), while 28% choosed normal and 26% choosed low. It means that characteristic of people condition is an important thing for Islamic economics development, in this case is Bank Muamalat Indonesia Palangka Raya Branch. Based on respondent's opinion in the table 1.8. above, social setting aspect has significant role for public in Palangka Raya to respond the existence of Bank Muamalat Indonesia Palangka Raya Branch.

## **5. Conclusion**

Based on analysis result to 150 respondents through questionnaire, so according to problem formulation in this research can be concluded as follows:

1. Public response to Bank Muamalat Indonesia (BMI) Palangka Raya Branch is good (positive). It showed by the result of research which mostly people in Palangka Raya (respondent) respond positively to the existence of Bank Muamalat Indonesia (BMI) Palangka Raya Branch.
2. Public response on the aspects of product, service, socialization, benefit and social setting is conformity to the expectation. In simple words, people in Palangka Raya accept the product and they are pleased with the performance of Bank Muamalat Indonesia (BMI) Palangka raya Branch.



## REFERENCES

- A, Chotib, 1962. *Bank dalam Islam*, Jakarta: Bulan Bintang.
- Abdurraahman, Masduha. 1992, *Pengantar dan Asas-asas Hukum Perdata Islam (Fiqih Muamalat)*, Surabaya: Central Media.
- Alsa, A, and Santoso, F.H. 1997. "Faktor-faktor Pendukung dan Penghambat bagi Dosen Kelompok Ilmu Sosial-Humaniora dalam Melakukan Penelitian melalui Lembaga Penelitian Gadjah Mada", *Jurnal Psikologi*, Years XXIV No. 1 June.
- Anwar, Neja Syamsul, 1995. *Permasalahan Produk-produk Bank Syari'ah: Studi tentang Bai Muajjal*, Yogyakarta: P3M IAIN Sunan Kalijaga.
- Anwar, Syamsul, Permasalahan Produk-produk Bank Syari'ah: Studi tentang Bai Muajjal (P3M, IAIN Sunan Kalijaga, 1995).
- Arifin, Zainul, 1999. *Memahami Bank Syariah*, Jakarta: P.N. Alvabet.
- BAPPEDA & BPS, Kota Palangka Raya dalam Angka (Palangka Raya: BPS, 2005)
- Basyir, A. Azhar, 2000. *Asas-asas Muamalat (Hukum Perdata Islam)*, Yogyakarta: Perpustakaan Fak. Hukum UII.
- \_\_\_\_\_, 1994. *Refleksi Atas Persoalan Keislaman: Seputar Filsafat, Hukum, Politik dan Ekonomi*, Bandung: Mizan.
- \_\_\_\_\_, 1993. *Asas-Asas Muamalat (Hukum Perdata Islam)*, Yogyakarta: Perpustakaan Fak. Hukum UII.
- Busyaib, Hamid dan Mursyidi Prihantoro (ed.), 1993. *Bank Tanpa Bunga*, Yogyakarta: Mitra Gama Widya.
- Fauzi, Yuslam. "Peranan, peluang dan Tantangan Bank Syari'ah Sebagai Salah Satu Lembaga Pemberdayaan Umat dalam Memasyarakatkan Ekonomi Syari'ah", Article in National Seminar on Islamic Economics and Congress of KoKaSEI - Indonesia, Semarang, 12 May 2000.
- Muslehuddin, Muhammad, 1994. *Sistem Perbankan dalam Islam*, Jakarta: Cet. II, PT. Rineka Cipta.
- Nadirsyah, 1999. "*Bunga Bank dalam Perspektif Islam*", *Yurisdiksi* First Edition.
- Perwataatmadja, H. Karnaen dan H. Syafi'i Antonio, 1992. *Apa dan Bagaimana Bank Islam*, Yogyakarta: PT. Veresia Grafika.
- \_\_\_\_\_, 1992. *Peluang dan Strategi Operasional Bank Muamalah Indonesia*, in M. Rush Karim (Ed) *Berbagai Aspek Ekonomi Islam*, Yogyakarta: Tiara Wacana dan FE UII.
- Priyono, A.E., 1998. "Periferalisasi, Oposisi, dan Integrasi Islam di Indonesia (Menyimak Pemikiran Kontowijoyo)", in Dr. Kontowijoyo, *Paradigma Islam*, Bandung: Mizan.

- Siddiqi, Nejatullah, *Kemitraan Usaha dan Bagi Hasil dalam Hukum Islam*, (Jakarta: Dana Bhakti Prima Yasa, 1992).
- Singarimbun, Masri dan Sofyan Effendi, 1989, *Metode Penelitian Survey*, Jakarta: LP3ES
- Supardi, 2005. *Metode Penelitian Ekonomi & Bisnis*, Yogyakarta: UII Press
- Syafi'i, Muhammad Antonio, "Konsep Syariah dalam Bank Islam", Article *Short Course: Bank Syariah Prospek dan Operasional*, Penyelenggara: Lembaga Pendidikan dan Pengembangan Bank Syariah (LPPBS).
- Syihab, Umar, 1996. *Hukum Islam dan Transformasi Pemikiran*, Semarang: Dina Utama.
- Law No. 10 of 1998 jo Law No. 7 of 1992 on Banking, Jakarta: First Edition, Sinar Grafika.
- Wahid, Agus, 1995. Dilema BMI di Tengah Tuntutan Umat, *Ulumul Qur'an* No. 4, Vol. Vi.
- Ya'qub, Hamzah, 1999. *Kode Etik Dagang: Pola Pembinaan Terkait Hidup Alam Berekonomi*, Bandung: CV. Diponegoro
- Yusdani, 2002. "*Transaksi (Akad) dalam Perspektif Hukum Islam*", Yogyakarta: Millah, Vol. II, MSI UII.

**Topic :** Socio-Humaniora

## **Fairytale Roles in Family Communication as Effort to Encourage Early Childhood Development: Literature Study**

Uha Julaeha<sup>a</sup>, Anissa Faradilla<sup>b</sup>

<sup>a</sup>*Communication Science Faculty, Padjadjaran University, Jalan Raya Badung-Sumedang  
KM 21, Jatinangor 45363, West Java, Indonesia*

<sup>b</sup>*Psychologic Faculty, Padjadjaran University, , Jalan Raya Badung-Sumedang KM 21,  
Jatinangor 45363, West Java, Indonesia*

---

### **Abstract**

Fairytale becomes a family communication tools needed to teach moral values in children. However, there are still a few families applying fairytale in their communication activities. Increasingly rampant child care services prove that many parents are not confident in their ability to care for children. Moreover, anxiety of parents toward the child inaction in adapting establish parents enter their children to school as early as possible without considering the readiness of the child. This affects the creativity of parents serve communication. Whereas, the family as the smallest institution in a society authoritative the child's basic independence. The data from this research based on literature review. Based on Pupung Puspa Ardini researches data entitled "*Pengaruh Dongeng dan Komunikasi Terhadap Perkembangan Moral Anak Usia 7-8 Tahun*" with 60 children samples which be placed on experimental class and control class between fairytale and folktale, the most average high communication skill occurs from fairy tale class. It happened because fairytale have variety plots with various vocabularies. Continuously, fairy tale able to provide reciprocal emotionally and psychologically. The seriousness of the parents in finding the fabled quality reading material is needed to support their children's development. With consistently storytelling activity, parents have a duty to prepare the best reading material for their children and applicable to the real environment.

### **Keywords**

Family Communication, Psychology, Parenting, Parent-children Interaction, Fairytale.

---

## **1. Introduction**

### *1.1. family communication*

Family communication simultaneously manipulates interpersonal communication. Family Communication more than just the exchange of words between family member. (Thames, s.a.). On family communication, there are two

---

\* Corresponding author. Tel.: +62-8967353403;  
E-mail address: uhajula@gmail.com

orientation patterns: *conversation orientation* and *conformity orientation*. *Conversation orientation* refers the degree where members of a family noticed communication as a primary tool to maintain family trust. And *conformity orientation* refers the furthest degree family believe that communication should emphasize homogeneity of attitudes, beliefs, and values. (Koerner & Fitzpatrick, 1997, 2014).

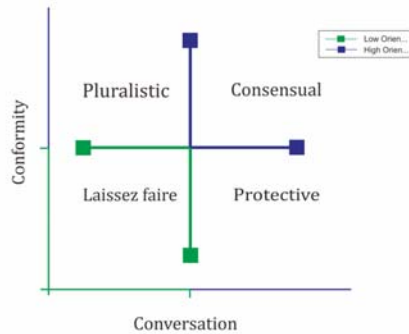

Figure 1. Four Types Family Communication Pattern (Koerner & Fitzpatrick, 2004)

The effect of two dimensions of communication in families created four family types that are qualitatively different: *consensual*, *pluralistic*, *protective*, and *laissez-faire* (see on fig.1.). In *Consensual* families, parents are very interested in what their children have to say, but at the same time, the parents consider themselves the final decision makers. They resolve the tension by listening to their children and spend time and energy in explaining their decision, value and beliefs and decisions hoped that their children understand the reasoning behind their decisions. *Pluralistic* families are characterized by open, consentrained discussions that involve all family members and a wide range of topics. Parents do not feel a need to be in control of their children, to make decisions for them or to agree with their decisions. Opinions are openly discussed and evaluated based on argumentative support rather than on who promotes the argument. *Protective* families are characterized by an emphasis on obedience to parental authority and by little concern for conceptual matters or for open communication within the family. Parents tend to make decisions for the children and see little value in explaining their reasons to their children. *Laissez-faire* families are characterized by few and often lifeless interactions between family members that involve only a limited number of topic. Parents tend to believe that all family members should be able to make their own decisions. In contrast to other families, parents show little interest in their children’s decisions; therefore, conflicts are rare. (Koerner & Fitzpatrick, 1997, 2014; 2004; Alm, 2015).

Family communication enable to establish communication climate between their members. And influence child acquisition to adopt communication from their parents. Moreover, family as a smallest institution member unit of society, is the first teacher on explaining daily activities as child's basic independence.

Unfortunately, Increasingly rampant child care services prove that many parents are not confident in their ability to care for children and depending on the caregiver. Another for example, anxiety of parents toward the child inaction in adapting establish parents enter their children to school (pra-school; kindergarten) as early as possible without considering the readiness of the child. Whereas, parents do not

certainly know how that school nurtures their children. They only know from school branding.

### *1.2. Childhood development*

Development influence personality and it is important to individual traits. Individu's personality formed when their child especially early childhood. Early childhood period spanned the years from birth through age 8. (NAEYC, 2009). Its boundaries refers to the child who have not reach school age.

Generally, human learn behavior from interaction, and observation of social context. (Bandura, 1986). Bandura (1997) said that the new response patterns are acquired by direct experience or by observation (in the form of modeling, imitation, and vicarious experience). Two important components are symbolic activity (allows individu to process information and to remember it using words and idea that serve for future behavior) and self-regulatory capacities (the ability to monitor one's own behavior according to antecedents and consequences).

### *1.3. Fairytale*

Folklore is plural form form 'folk' and 'lore'. Folk is a similar word with 'collective and keep of physical, social, and cultural. Lore has mean of hereditary culture heritage. There are so many kinds of folklore. One of them be formed by folk-prose like myth, legend, and folktale. (Bascom, 1965). Civilization which has time dimension encounter form presentment evolution. Folktale rated folk-prose old version and the modern version is a fairy tale. Fairytale becomes a family communication tools needed to teach moral values on social context for children. It happened because fairytale has variety plots. However, there are still a few families applying fairytale in their communication activities.

According to Bowlby theory (1958), there are two kinds of attachment: secure and insecure. Positive relationship formed from prepared secure. (Santrock, 2011). Parents-child secure could become a quality time form. Quality time is not just how many parents spend time together with their children, but also how much quality activities have been done with their children. Fairytale could bridge to form an attachment because fairytale activities require activities together between parents and children. Attachment build trust-feeling both of them.

Furthermore, fairytale enables become one way to fulfill physical, social, and emotional needed by its plot. Fairytale also can expand socio-emotional of child by extending moral value about good or bad behavior.

## **2. Material and Methods**

### *2.1. Literature Material Collection*

This research is using literature study taken from various published journals. The journal from Internet sources is entirely free full text. It retrieval used three primary subjects: family communication, early childhood, and fairy tale. Appropriate journal selected manually based on the needed topic to be included as literature.

### *2.2. Method Discussion*

This research used descriptive paragraph to explain literature review. Research object concentration began by asking questions: "Is there role to encourage early childhood development through the kind of fairytale on family communication?". Research discussion started out with a discussion about family communication, then the problems occur in family communication that make gape for children to express their feelings. Especially between parents and early childhood. After that, the author finds alternative solution to build communication between parents and early childhood as effort to negotiate problems on these family communication by interactive fairytale. The kind story is fairytale to help encourage child development.

### 3. Discussion

The ability of parents to make a communicating climate affects family communication. Probably, children often feel discomfort in expressing their feel caused parenting problems like excessive sanction, hyper protection, insufficient requirements, encouragement of infantilism, and undeveloped parental feeling. There are differences in the orientation of family communication between father and mother (especially fathers to sons) can be entered in the communication approach based on gender. A good family interaction represents the climate and good family atmosphere. In hope, family communication pattern has entered a phase consensual type. Where the parents give an opportunity to their children to define themselves by reviews their own way.

Parents usually have spare time during weekday and weekend. Parents should prepare quality time to interact with their children proved that they show an affection for the child.

Table 1 Activities carried out strenghtening relationship (Havigerová, 2015)

Rank	Activity (Categorised)	Absolute Frequency	Relative Frequencies
1	Talking	25	17.99%
2	Reading	22	15.83%
3	Games	19	13.67%
4-7	outdoor Activities	13	9.35%
4-7	Interests and Hobbies	13	9.35%
4-7	Works	13	9.35%
4-7	Just Being Together	13	9.35%
8	physical Contact	12	8.63%
9	Sport	8	5.76%
10	Learning	1	0.72%
TOTAL		139	100%

The table above describes interaction frequency on weekdays (5 days x 4 hours) and weekend (2 days x 10 hours) between parent-child. The results showed that the activity of reading into the second interaction is often done. And most quality interaction time is on weekdays.

Based on the data Researches Pupung Puspa Ardini entitled "Pengaruh Dongeng dan Komunikasi Terhadap Perkembangan Moral Anak Usia 7-8 Tahun" or in English is "Tales Influence and Communication Against Childhood Moral Development 7-8 Years", the average number of children who have high communication skills lies in

the modern fairy tale compared to the class folktale. This is cause modern fairy tale has a groove varied with diverse vocabulary.

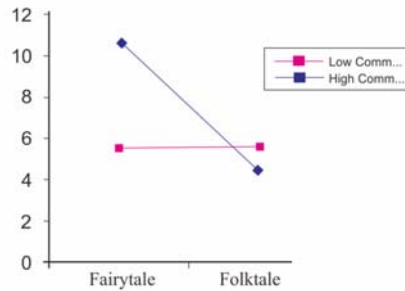

Figurev2. The average score of Communication and Moral Development of Tale (Ardini, 2012)

The picture above explains the differences fairy tale quality affects communication abilities. There are four results of research stretcher: wide fairytale storyline is very interesting children to continue to listen to stories and enrich children's vocabulary information; there are significant interactions between fairy tale with communication capabilities. Groups of children with high communication skills have a higher courage to express the ideas of the story when the storyteller gives a chance to choose the storyline, making it easier to gain an understanding of social values; moral development of children who have high communication skills and given a modern fairy tale fantasy is higher than children who are given the traditional fairy tale. They have the ability to be more spontaneous and daring convey ideas when modern fairy tale fantasy takes place; and moral development of children aged 7-8 years who have poor communication skills have no differences between the groups were given a fairytale modern fantasy and traditional storytelling. This is because the traditional tales and modern fantasy are interesting for children to observe.

#### 4. Results

The best approach might be a parent do to build a family communication, such as:

1. Listeners / Active listening. Listen carefully what their want. Encourage children to talk and express feeling.
2. Be open-minded. When parents speak with their childhood with preaching. Indirectly, the child is limited in the act or say something. Thus, communication is merely instructions.
3. Avoid to speak up. Avoid say anything that could hurt and make-traumatic.

Fairytale potentially to approach family communication pattern. Activity in story telling has two-way interaction between the communicator (the parent) and communicant (the kids). Thus, fairy tales can be used for activities both indoors and outdoors on the parent-child quality time. The feedback that appears a proactive action depends on the presentation of a fairy tale. Content can be presented in the form of a fairy tale: reading with intonation in accordance with the flow; kinesthetic by demonstrating specific grooves; or use hand puppet. So choosing a fairy tale in interacting not be an obstacle because every parent has a different storytelling skill.

In the narrative fairy tale, often illustrated how to behave in a good society. Therefore, fairytale is able to stimulate the communication of children emotionally

and psychologically. For example illustrates the value and ethics to be aware of how to respect the old and cherish the young; improve emotional intelligence in order to develop of sympathy and empathy; stimulate children have a large imagination, able to think out of the box; improve verbal skills, and develop interest in reading to improve their language skills.

How to tell stories that can be used:

- a. Read a narrative. The most basic way is used for parents who have difficult to express themselves. These difficulties can be covered by adding image features on a book of fairy tales. So the children’s imagination on the picture has an audial effects from the narrator. To make more attractiveness, bring more than one book to choose by children.
- b. Using a hand puppet, both finger puppets and hand puppets. Supporting equipment like that was intentionally provided by parents to tell stories. It also shows the seriousness of parents in the storytelling. And usually, parents who use this method have been adept at processing into a form kinesthetic imagination.
- c. Using appliances. Such as kitchen utensils, toiletries, and so on. It is shown that every activity, there are many lessons to be drawn. And trigger the child's imagination. Fairy tales activity could be done during the hours weekdays. Usually when weekdays, all family have free time. And is used to gather with family. The best time to gather is between 19:00-up to bedtime.

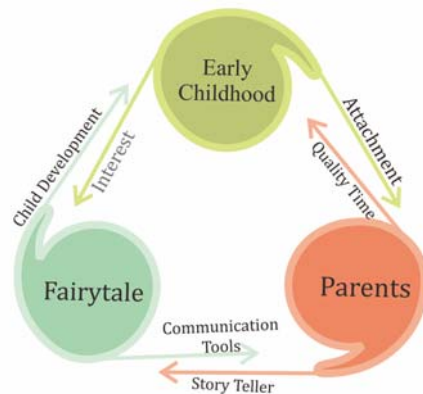

Figure 3. Concept of Interaction Fairytale-family (Julaeha; Faradilla, 2016)

## 5. CONCLUSION

Fairy tale has a proper test to use in the system of teaching and learning activities of children through adolescence. Through communication family, fairy tale has a potential to promote early childhood development. This is occurring cause there are various interactions in a fairy tale, in the presence of a fairy tale. At least by reading the narration. Thus, fairy tales can be applied to the family. Even though every family has different skills to telling a story.

Continuously, fairy tale able to provide reciprocal emotionally and psychologically. The seriousness of the parents in finding the fable quality reading material is needed to support their children's development. With consistently storytelling activity, parents have a duty to prepare the best reading material for their children and applicable to the real environment.



## REFERENCE

- Anderson, J. A. (2016). Communication Descending. *The International Communication Gazette*, 0(0), 1-9.
- Ardini, P. P. (2012). Pengaruh Dongeng dan Komunikasi Terhadap Perkembangan Moral Anak Usia 7-9 Tahun. *Jurnal Pendidikan Anak*, 44-58.
- Bakar, A. A., & Afthanorhan, A. (2015). Confirmatory Factor Analysis on Family Communication Patterns Measurement. *219(Social and Behavioral Sciences)*.
- Brown, J. A. (2016). Parent-Implemented Communication Intervention: Sequential Analysis of Triadic Relationship. *Topics in Early Childhood Special Education*, Vol.36(2); 115-124.
- Cress, C. J., et al. (2013). Contingent Interactions Between Parents and Young Children With Severe Expressive Communication Impairments. *Communications Disorders Quarterly*, 34(Communications Disorders Quarterly), 81-96.
- Danandjadja, J. (1984). *Folklore Indonesia: Ilmu Gosip, Dongeng, dan lain-lain*. Jakarta: Grafiti Pers.
- Dawn O. Braithwaite. (2006). *Engaging Theories in Family Communication: Multiple Perspectives*. United States of America: Sage Publications.
- Grebelsky, T. (2016). Verbal Versus Nonverbal Primacy: Children's Response To Parental Incongruent Communication. *Annual International Scientific Conference Early Childhood Care and Education 2016* (pp. 1-26). Moscow: Elsevier.
- Havigerova, J. M., et al. (2015). Common Activities of Parents and Preschool Children Strengthening Their Relationship. *Social and Behavioral Sciences*, 197-201.
- Hergenhahn, B., & Matthew H. Olson. (2010). *Theories Of Learning*. Jakarta: Kencana.
- Hurlock, E. B. (1978). *Child Development 6th ed*. USA: Mc-Graw-Hill.
- Kopp, C. B. (n.d.). *The Child: Development In A Social Context*. Los Angeles.
- Kulikovskaya, I. E., & Andrienko, A. (2016). Fairy-tales for Modern Gifted Preschoolers: Developing Creativity Moral Values and Coherent World Outlook. *Annual International Scientific Conference Early Childhood Care and Education 2016* (pp. 53-57). Moscow: Elsevier.
- Medford, E., & McGeown, S. (2016). Social, Emontional and Behavioural Influence on Young Children's Pre-Reading and Word Reading Development. *Journal of Applied Developmental Psychology*, 54-61.
- Patmonodewo, S. (2003). *Pendidikan Anak Prasekolah*. Jakarta: Rineka Cipta.
- Runcan, P. L., et al. (2012). The Role Of Communication in The Parent-Child Interaction. *Social and Behavioral Sciences*, 904-908.
- Samokhvalova, A. G. (2016). Parenting Mistake as a Factor in Communication Difficulties in Children. *Annual International Scientific Conference Early Childhood Care and Education 2016* (pp. 123-127). Moscow: Elsevier.
- Santrock, J. W. (2011). *Child Development 13th Ed*. New York: Mc Graw-Hill.
- Schrodt, P., et al. (2009). Family Communication Patterns as Mediators of Communication Competence in the Parent-child Relationship. *Journal of Social and Personal Relationship*, 26(6-7), 853-874.
- Shabas, S. (2016). Relationships Between Parents and Preschool-Age Children Attending Kindergartens. *Annual International Scientific Conference Early Childhood Care and Education 2016* (pp. 269-273). Morcow: Elsevier.
- Wildova, R., & Jana, K. (2015). Early Chilhood Pre-reading Literacy Development. *WCES 2014* (pp. 878-883). Elsevier.
- Yildirim, A. (2016). Creativity in Early Childhood Education Program. *WCLTA 2010* (pp. 1561-1565). Elsevier.
- Young, N. A. (2013, March 1). *Early Childhood Education From Birth Through Age 8*. Retrieved October 28, 2016, from NAEYC: [https://www.naeyc.org/files/naeyc/NAEYC\\_ECE\\_Bto8\\_Handout\\_2013.pdf](https://www.naeyc.org/files/naeyc/NAEYC_ECE_Bto8_Handout_2013.pdf)

Zhdanova, S. Y., et al. (2016). Mother's Knowledge of Child Individuality as a Parent-child Relationship Development Factor. *Annual International Scientific Conference Early Childhood Care and Education 2016* (pp. 413-417). Moscow: Elsevier.

**Topic :** Socioeconomics Relations

**Economic Thought Of Ibn Taimiyah On Market Mechanism In  
Perspective Of Moslem Scholars**

Dr. Ahmad Dakhoir, SHI, MHI<sup>a</sup>, Itsla Yunisva Aviva, M.Esy<sup>b</sup>.1

<sup>a</sup>Lecturer of Economic Law, State Islamic Institute (IAIN) of Palangka Raya, Jl. G. Obos  
Komplek Islamic Center No. 24, Palangka Raya 73112, Indonesia

<sup>b</sup>Lecturer of Islamic Economic, State Islamic Institute (IAIN) of Palangka Raya, Jl. G. Obos  
Komplek Islamic Center No. 24, Palangka Raya 73112, Indonesia

---

**Abstract**

According to the capitalist economy concept, the best market is free market which the prices for goods and services are determined by supply and demand principle. Consequently, role of the government in economic must be minimized. Otherwise, market in socialist paradigm, it should be kept from fall into greedy capital owner so that monopoly of means of production will not happen. By its thought, government should determine the prices as well as distribution and supply of goods so there is no excuse for free market. On other side, Islamic Economics considers that market, government and people are equal (*iqtishad*), there is no sub-ordinat makes one more dominant than others.

This paper aims to study IbnTaimiyah Thought of market mechanism in Islamic Scholars perspective.

Conclusion of this paper draws thought of Ibn Taimiyah that point out the beauty of market (the beauty of market mechanism as a mechanism of economy), with all its shortcomings. Governmental intervention in market is justified in specific cases.

**Keywords**

Market Mechanism, Economic Thought, Ibn Taimiyah

---

---

<sup>1</sup> Telp. Fax: +62 536 3222105.

E-mail address: [ahmad.dakhoir@iain-palangkaraya.ac.id](mailto:ahmad.dakhoir@iain-palangkaraya.ac.id) ; Phone: +62 81230665255

Email address: [itsla.yunisva@gmail.com](mailto:itsla.yunisva@gmail.com) ; Phone: +62 81957042050

# Economic Thought Of Ibn Taimiyah On Market Mechanism In Perspective Of Moslem Scholars

## 1. Background

Market practices basically should show right values according to norms and values which are justified. All forms of economic system wish to minimize shortcomings, poverty and trouble from human life. It means that an economic system works to create distributive justice among society.<sup>2</sup> Two notions in an economic system which have become reference and barometer of the world, those are capitalist economic system and socialist economic system, evidently can't provide satisfactory answers for all of the world's economic problems such as to control the mechanism of market activities which is unstable nowadays, in fact they make matters worse.<sup>3</sup>

Capitalist economic system wants the market to play important roles in an economic system and treats the market as a mechanism who is capable to solve economic problems. The core questions in an economic system are (1) what should be produced, (2) how to produce, (3) for whom goods and services are produced, these questions are believed to be responded well by the market.<sup>4</sup> A slogan in a capitalist economic system is *Laissez Faire* originated from French which means "Let them do their work as they wish". Essentially, this system gives full freedom to the community to determine their economic activities, as well as prices and market mechanism.

The market should not be interfered by anyone including the government. The government's role in a national economy is limited to the provision and development of infrastructures and public administration. An active government intervention will decrease the efficiency of economic activities. With the power of its invisible hand, the market will respond and control all of the economic problems harmoniously. A capitalist economic system is also known as a free market economic system. In this system, economic activities are controlled completely by the market mechanism or invisible hand.

On the other side, a socialist economic system which is created by Karl Marx wants to maximize the role of the government. The government should take control of all sectors of the economy to ensure equity for people starting from the means of production to redistribute to the workers, so that they benefit the work as well. The market in a socialist paradigm should be kept from falling into the greedy hands of the capitalist so that a monopoly of the means of production will not happen and they will not exploit workers to get profit as

---

<sup>2</sup>Abdullah Abdul Husain at-Tariqi, *Ekonomi Islam : Prinsip, Dasar dan Tujuan*, translated by M. Irfan Syofwani, (Yogyakarta: Magistra Insania Press, 2004), First Edition, p. 44.

<sup>3</sup>*Ibid.*, p. 48.

<sup>4</sup>Hendri Anto, *Pengantar Ekonomika Mikro Islami*, (Yogyakarta: Ekonisia, 2003), p. 314.

much as possible. Therefore, equilibrium will not happen, otherwise inequity will happen in the public economy. Government should play a significant role to realize equilibrium and equity of economy in market.<sup>5</sup>

According to this system, prices are determined by government, distributions of goods are controlled by government, so there is no freedom of the market. Citizens are workers who have to produce according to their capabilities and will get paid adjusted with their needs. All of economic activities or production should strived collectively. There is no private business, all enterprises, including farm, are state enterprises. What and how much production determined by central planning of the government and strived by state directly.

In contrast to the capitalist and socialist economic systems, Islamic economic considers that market, government and people are equal (*iqtishad*), there is no subordinat makes one more dominant than others. Islam places market in an important position of economic and ensure its independency. Market determines production methods and prices without interference that can upset the balance of the market. Despite the fact, hard to find a market that operate itself fairly. Distortion of the market still happens so that potentially detrimental to the stakeholders.

Market that operate itself (*laissez faire*), without controlling, in fact leads to market dominance by capital owner (capitalist), infrastructure ruler and owner of resources. Asymmetric information that can be a problem without solution by market. Government in Islam perspective has the same role as market, to control and supervise economy, ensure the competition in market running perfectly, equitable information as well as economic fairness. Its role as a ruler does not make it dominant, because state must not interfere market that running in balance, their role just needed when the distortion happened in market system. Even though Islamic economic still provides the opportunity, in certain cases, to do the price intervention when traders harm consumers through monopoly and cheating.

Thought of Ibn Taimiyah about market mechanism actually focused on price movements happened at the time, but he put it on market mechanism frame. Price mechanism is a process running based on gravitational pull among producers and consumers either from market output (goods) or input (production factors). As for the prices defined as money that states a purchase value of a thing. A fair price is price (value of goods) that paid for a thing or certain object which at the time and place the goods be given.<sup>6</sup> He showed *the beauty of market* (the beauty of market mechanism as a

---

<sup>5</sup><http://shariaeconomics.wordpress.com/tag/mekanisme-pasar-dalam-perspektif-ekonomi-islam/> accessed on 25 June 2013.

<sup>6</sup>Pusat Pengkajian dan Pengetahuan Ekonomi Islam (P3EI) UII Yogyakarta in collaboration with Bank Indonesia,

mechanism of economy), with all its shortcomings. He refused a price intervention which may disturb the freedom mechanism. As long as the fluctuation of supply and demand caused by natural factors. Intervention in market is justified in specific cases and also specifically.<sup>7</sup>

## 2. Market Mechanism In Islam

Islam is a perfect religion. Islam regulates about values, ethics and guidance of way of life comprehensively. Islam also completes other earlier religions and regulates all aspects of human life both issues of *aqidah* and *muamalah*. In muamalah aspect, Islam regulates relationship among human being in order to meet their daily needs including guidance of how to manage market and all form of its mechanism.

The teachings of Islam very appreciate market as a place of *halal* (legal) and *thayyib* (good) transaction so that is the most ideal mechanism of allocation and distribution of economic resources. In market, people are free to transact according to their needs and desires. Market mechanism is a power that are mass (impersonal) and natural so that reflect condition of people's economy comprehensively. In a perfect competition market, there is no one may control the market. Appreciation of Islam on market mechanism according to the word of Allah said the transaction or commerce should be done in a good way based on the principle of mutual pleasure (*rida*) so that created fairness. According to the word of Allah in Al-Qur'an, An-Nisa [verse 29]:

*"O you who have believed, do not consume one another's wealth unjustly but only [in lawful] business by mutual consent. And do not kill yourselves [or one another]. Indeed, Allah is to you ever Merciful".<sup>8</sup>*

Mutual pleasure condition contrary to tyranny, that is a condition when one side pleased and other side in misery. In price case, the fuqaha formulate it as the price of the equivalent. The price of the equivalent concept or *thaman al mithl* has important implication in economics that is the competitive condition of market.

---

*Ekonomi Islam*, (Jakarta: PT RajaGrafindo Persada, 2012), p. 307.

<sup>7</sup>*Ibid.*

<sup>8</sup>Departemen Agama RI, *Op.cit.*, p. 83.

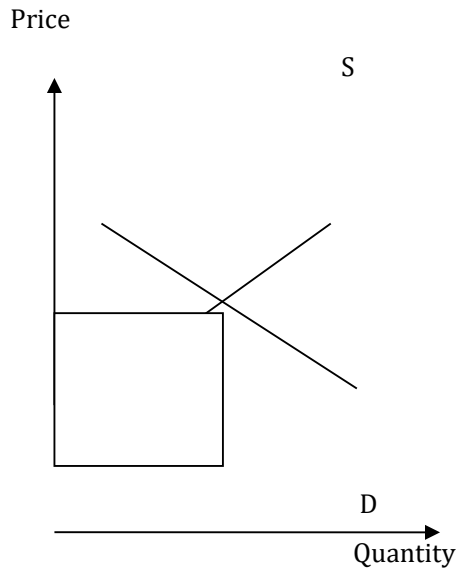

Market equilibrium will happens when links between supply and demand curves meet in condition of '*an taraddim minkum* (mutual pleasure). If this equilibrium disturbed, government should do an intervention to the market.

In Islamic economic concept price fixing determined by the power of supply and demand. In the concept of Islam, supply and demand should be happened in mutual pleasure, there is no one forced to transact at a certain price level.

*Monopoly, duopoly, oligopoly* in the meaning of only one, two or more seller are not prohibited in Islam, as long as they do not take advantage above normal profits. It is a consequence of the price of the equivalent concept. Producer who operate it with profits positively will attract other producers to go into that business, so the supply curve will shift to the right, number of output which is offered will increase and prices will decrease. New producers will keep on entering to this business until the prices drop down so that economic profit will be zero. In this case, old producers in market will not have an incentive to exit from the market and new producers who did not enter this market will not have an incentive to go into the market.<sup>9</sup>

However, Islam rejected market concept of free competition without restriction when it ignores norm and ethics. This market will not realize the objectives to reach *falah* nor distort it. In Islamic market, market actors pushed by spirit of competition to achieve kindness and collaboration and mutual assistance at once in a frame of Islamic values and morality. Islamic market is a free co-opetition market. Market actors not only pursuit of profit materially but also blessings of Allah. Market will be a place of commodities transactions where only *halalan thayyiban* so that *haram* will be abandoned. Market activities also reflects fair play competition, honesty, transparency

<sup>9</sup>Adiwarman Karim, *Op.cit.*, p. 153.

and justice with the result that just price as a prices created. In other word, this market does not contain deviation from Islamic values and morality.<sup>10</sup>

Islam regulate the competition in market should be done fairly. All forms that can make inequity are forbidden. Inequity and injustice mentioned above are:<sup>11</sup>

1. *Talaqqi Rukban* forbidden because trader in the suburbs got profit from inequity by village seller on prevailing prices in town. Prohibition for village seller to go into the town (entry barrier) will make uncompetitive market.
2. Reducing the scales is forbidden because the goods sold with the same price but the weight is less.
3. Hiding the defective items is forbidden because seller will get higher price for poor quality of goods.
4. Replacing dried dates with wet dates is forbidden because weight of wet dates are not the same with dried dates that replaced.
5. Replacing a peck of good quality of dates with two pecks of medium quality of dates is forbidden because each of those quality of dates have their own prices. The prophet Muhammad ordered to sell dates and then buy other dates used money.
6. *Najasy* transaction is forbidden because the seller asks other man either to praise or to bid his goods with high price so that other people will interested and come to him.
7. *Ikhtikar* is take advantage above normal profits through sell the goods less for higher price and it is forbidden.
8. *Ghaban faa-hisy* (large) is sell above the market price and it is forbidden.

### **3. Market Mechanism Of Ibn Taimiyah In Perspective Of Adiwarmar Karim**

Ibn Taimiyah has a clear understanding about the condition in free market which the prices determined by supply and demand power. He said:

*“Rise and fall in price is not always due to injustice of some people. Sometimes its reasons is deficiency in production or decline in import of the goods in demand. Thus, if the desires for the good increase while its availability decrease, its price rises. On the other hand if availability of the good increases and he desires for its decrease, the price declines. This scarcity and abundance may not be caused by the action of any people, it may be due to a cause not involving injustice, or sometimes it may involve injustice. This is totally Allah’s omnipotence that created desire in the depths of the human heart”.*<sup>12</sup>

---

<sup>10</sup>P3EI UII Yoyakarta and BI, *Op.cit.*, p. 83.

<sup>11</sup>Adiwarmar Karim, *Op.cit.*

<sup>12</sup>Ibnu Taimiyah, *Majmu’ Fatawa Syaikh al-Islam*, (Riyadh: Matabi’ al-Riyadh.1963), Vol. 8 p.583, in Adiwarmar Karim, *Sejarah Pemikiran Ekonomi Islam*, (Jakarta: PT RajaGrafindo Persada, 2012), Third Edition, p. 364



Based on the statement above, we will know that at the time of Ibn Taimiyah, fluctuation of the prices assumed as the effect of despotism of the traders. According to the Ibn Taimiyah, that assumption is not always true. He explained specifically various of economic reasons of the fluctuation of the prices as well as the role of market power in this case.

Ibn Taimiyah mentioned two supply resources, those are local production and import of demanded goods (*ma yukhlaq aw yujlah min dzalik al-mal al-matlub*). To draw this demand of goods, he used the term *raghbah fi al-syai* which means the desire for something, that is goods. The desire is the most important factor of demand, other factor is people's income but it was not mentioned by Ibn Taimiyah. The change of supply draws as the supply fluctuation of goods, due to two factors those are local production and import.<sup>13</sup>

Other factors that affect supply and demand are the intensity and magnitude of demand, lack or abundance condition of the goods, trusts as well as discount and cash payment. Demand of the goods is fluctuating occasionally. The fluctuation depend on the numbers of supply, numbers of people who want it, and people needs of that item. If this interpretation is correct, Ibn Taimiyah has correlated the high price with intensity of needs as the relative importance of goods to the buyer's total needs. If needs are larger, the prices will increase, and otherwise.<sup>14</sup>

Statement of Ibn Taimiyah above shows something known as changes in the supply function (supply) and demand, that is happened when demand increases on the same price and supply decreases on the same price or otherwise, demand decreases on the same price and supply increases on the same price. If supply decreases and demand increases at once, the prices will rise certainly and vice versa.

However, both of these changes is not always in tandem. If demand increases while supply stable., the prices will increase. Ibn Taimiyah explained:

“If people sell their goods in a way that is acceptable generally without despotism and prices rise as a consequence of decrease in the number of goods (*qillah al-syai*), or increase in the number of population (*katsrah al-khalq*), this condition caused by Allah's omnipotence”.<sup>15</sup>

In the statement above, Ibn Taimiyah mentioned that price increases caused by decrease in the number of goods or increase in the number of population. Decrease in the number of goods may be called as decreased supply, whereas increase in the number

---

<sup>13</sup>Adiwarman Karim, *Sejarah Pemikiran Ekonomi Islam*, (Jakarta: PT RajaGrafindo Persada, 2012), Third Edition, p. 365.

<sup>14</sup>Adiwarman Karim, *Ekonomi Islam Suatu Kajian Kontemporer*, (Jakarta: Gema Insani, 2001), p. 160-161.

<sup>15</sup>Ibnu Taimiyah, *al-Hisbah fi al-Islam*, (Kairo: Dar al-Sha'b,1976), p. 24, in Adiwarman Karim, *Sejarah Pemikiran Ekonomi Islam*, (Jakarta: PT RajaGrafindo Persada, 2012), Third Edition, p. 365.

of population may be called as increased demand. The price increases caused by decreased supply or increased demand characterized as Allah's omnipotence to show that market mechanism is impersonal.<sup>16</sup>

Quotes above indicate that when want to analyze the implication of supply and demand changes to the prices, Ibn Taimiyah did not consider effect of price level to the level of demand and supply. Moreover, he stated that price fixing determined by government through a way cutting profits of traders will lead it to damage prices, the concealment of the goods by the traders as well as it will damage public welfare.<sup>17</sup> In other word, government policy like that can lead it to disappearance of goods from market. Ibn Taimiyah realized if supply of the goods is decreasing it will make the prices fall down drastically. Accordingly, Ibn Taimiyah was so conscientious when observed links between prices and supply of the goods.

Ibn Taimiyah noted any factors that affect demand and its consequence to the price, those are :<sup>18</sup>

1. People's desire (*raghbah*) to every kind of goods which are different and always changing. This changing according to the lack or not of items those demanded. If the number of the goods is less it will be more desirable for people.
2. The number of enthusiasts (*tullab*) to the items. If the numbers of people who want an item is bigger, price of that item will rise and otherwise.
3. Low or high the needs of an item as well as level of needs. If the needs is high, price will rise. Otherwise, if the needs is low, the price will down.
4. The quality of buyer. If the buyer is moneybags and trusted to pay debts, the given price will be lower. Otherwise, the given price will be higher if the buyer is insolvent.
5. Type of money that used. The price will be lower if payment use money that is commonly used (*naqd ra'ij*) than money that is rarely used.
6. The aim of the transactions wants reciprocal ownership among both sides. Price of an item that available commercially lower than price of an item that is not available in the market. And price will be lower if payment is made in cash than installment payment.
7. The number of the costs by producers or sellers. Higher cost of production will make the price higher as well, and vice versa.

---

<sup>16</sup>Adiwarman Karim, *Sejarah Pemikiran Ekonomi Islam*, (Jakarta : PT RajaGrafindo Persada, 2012), Third Edition, p. 366.

<sup>17</sup>Ibnu Taimiyah, *al-Hisbah fi al-Islam*, (Kairo: Dar al-Sha'b,1976), p. 41, in Adiwarman Karim, *Sejarah Pemikiran Ekonomi Islam*, (Jakarta: PT RajaGrafindo Persada, 2012), Third Edition, p. 366.

<sup>18</sup>Ibnu Taimiyah, *Majmu' Fatawa*, Op.cit., Vol. 29 p.523-525 in Adiwarman Karim, *Sejarah Pemikiran Ekonomi Islam*, (Jakarta: PT RajaGrafindo Persada, 2012), Third Edition, p. 366.

#### 4. Market Mechanism Of Ibn Taimiyah In Perspective Of Veithzal Rivai

Ibn Taimiyah explained about market mechanism that, in his point of view, fluctuation of the price level is not always as consequence of injustice that has done by someone, but frequently appear because either underproduction or the number of imports has decreased. Increased demand that not balanced with increased supply or production of the goods will push up the price of goods. Whereas, increased supply or production followed by decreased demand will lower the prices.<sup>19</sup>

The concept of just price/price of the equivalent related to the aspect of economy, whereas the concept of just compensation/compensation of the equivalent related to ethics and law. According to Ibn Taimiyah in perspective of Veithzal Riva'i, just price is more dynamic determined by interaction between supply and demand as well as affected by the desire of someone to the business activities. In other side, just compensation is a normative phenomenon that durable because it is a well established habits.

Scarcity problems, that is an important problem of economy viewed from classic economics, it can be caused by no one, but it can be caused by injustice or inequity in economic activities. Then explained that supply of goods coming from two resources these are local (domestic) and import. The number of goods supply affected by number of stock that available while demand determined by desire of people which income is the main component that affected demand.<sup>20</sup>

Factually, factors that affected demand according to Ibn Taimiyah are as follows:<sup>21</sup>

1. People's demand is various (people's desire). This factor depend on number of goods that available, a goods will be preferred if the number of goods is smaller (scarce) than plentiful.
2. Depend on the number of people who need the goods (*consumer*). Higher enthusiasts will make the value of goods higher as well.
3. It also affected by needs intensity of a goods. The higher its intensity will make value of goods be more higher.
4. It affected by the quality of consumers. If consumer is moneybags and trusted so that the price of goods will be lower than if consumer is an insolvent.
5. It also affected by the types of money which used as a payment instrument. If use money that commonly used, that price will be cheaper compared to the money that rarely used.

---

<sup>19</sup>Veithzal Riva'i and Andi Buchari, *Islamic Economics: Ekonomi Syariah Bukan Opsi Tetapi Solusi!*, (Jakarta: PT Bumi Aksara, 2009), p. 375.

<sup>20</sup>*Ibid.*,

<sup>21</sup>*Ibid.*, p. 375-376.

From those descriptions above, factually the thought of Ibn Taimiyah noticeably is relevant to the economic principles nowadays.

### **5. Market Mechanism Of Ibn Taimiyah In Perspective Of Muhammad**

Ibn Taimiyah explained clearly about mechanism of exchange, free market economy and how the fluctuation of prices happened due to supply and demand, despite he did not read books about market mechanism.<sup>22</sup> In this case, Ibn Taimiyah said:

*“Rise and fall in price is not always due to injustice of some people. Sometimes its reasons is deficiency in production or decline in import of the goods in demand. Thus, if the desires for the goods increase while its availability decrease, its price rises. On the other hand if availability of the good increases and he desires for its decreases, the price declines. This scarcity and abundance may not be caused by the action of any people, it may be due to a cause not involving injustice, or sometimes it may involve injustice”.*<sup>23</sup>

At his time, it was an assumption that price increases is an effect of injustice and unlawful act by seller, or it may be caused by market manipulation, so that Ibn Taimiyah denied it directly. His denial stated as quotation above. Therefore, if demand for goods increase while its availability decrease, its price rises, and vice versa. Scarcity and abundance of the goods may be due to fair action, or may be unfair action.<sup>24</sup>

According to Ibn Taimiyah, supply may come from domestic production and import. The changes of supply draws as a fluctuation of number of the goods that offered, while demand determined by desire and income. High or low of price increases that happened is Allah’s omnipotence. As affirmed by Ibn Taimiyah below:

*“If people are selling their goods according to community accepted manner without any injustice on their part and the price rises due to decrease of the community or due to increase in population, then this is due to God’s doing”.*<sup>25</sup>

Those matters shows essential that impersonal. Differentiated also by Ibn Taimiyah, factors that cause shifting between demand and supply curves, these are auto market pressure and unlawful act by seller, for example hoarding. And other factors are intensity and the number of demand, scarcity or abundance of the goods, the condition of trust and discount from spot cash.

Ibn Taimiyah also explained that the effect of changes in demand and supply to the market prices, he did not identify the higher or lower effect of prices on quantity that demanded or offered. However, in his book named *al-Hisbah*, he showed that government policy will affect supply and demand, as follow:

---

<sup>22</sup>Muhammad, *Ekonomi Mikro Dalam Perspektif Islam*, (Yogyakarta: BPFY-Yogyakarta, 2004), p. 357.

<sup>23</sup>Ibnu Taimiyah, *Majmu’ Fatawa Shaikh al-Islam Ahmad Ibnu Taimiyah*, (Riyadh: al-Riyadh Press, 1381), Vol. 8, p.583 in Muhammad, *Ekonomi Mikro Dalam Perspektif Islam*, (Yogyakarta: BPFY-Yogyakarta, 2004), p. 357.

<sup>24</sup>Muhammad, *Op.cit*.

<sup>25</sup>Ibnu Taimiyah, *Al-Hisbah fi al-Islam*, (Cairo: Dar al-Sha’b, 1976), p. 24 Muhammad, *Ekonomi Mikro Dalam Perspektif Islam*, (Yogyakarta: BPFY-Yogyakarta, 2004), p. 358

*“In that administrative setting of too low a price that the leaves no profit result in a corruption of prices, hiding of goods (by sellers) and destructions of people’s wealth”.*<sup>26</sup>

Demand for the goods oftentimes changed. The changes depend on the number of availability, the number of people who desire the goods, and high or low the level of needs for the goods. If it correct, Ibn Taimiyah has correlated the high price with intensity of needs as the relative importance of goods to the buyer’s general needs. If needs are larger, the prices will rise, and vice versa.<sup>27</sup>

In other side, Ibn Taimiyah identified other factors that determine supply and demand which it can affect the market prices, as follows:<sup>28</sup>

1. Intensity and the number of demand.
2. Scarcity and abundance of the goods.
3. Condition of charge account/debts.
4. Discounted of spot cash.

As Ibn Taimiyah stated below:

*“People’s desire is of different kinds and varies frequently. It varies according to the abundance or scarcity of the good demanded. A good is much more strongly desired when it is scarce than when it is available in abundance. It varies also depending on the number of demanders. If number of persons demanding a commodity is large, its price goes up as against whwn their umber is small. It is also affected by the strength and weakness of the need for the good and by the extent of the need, how great or small is the need for it. If the need is great and strong, the price will increase to an extent greater than if the need is small and weak. Price also varies according to the customer with whom exchange is taking place. If he is well-off and trustworthy in paying debts, a small price from him is acceptable to the seller which (price) would not be acceptable from one who is known for his insolvency, delay in payment or refusal of payment due”.*<sup>29</sup>

Prices also affected by level of trust to those who involved in the transaction. If someone is quite rich and trusted to pay his credit, the seller will be happy to transact with him. But, if his credibility in credit is doubted, the seller will doubt to transact with him and will set the higher price.<sup>30</sup>

The things should be noted about competition and imperfection of market is that Ibn Taimiyah never use the term “competition” (this concept appear lately in evolution of economic thought), whereas he explained condition of perfect competition that be a jargon of contemporary economy, this case shows clearly that he realized the

---

<sup>26</sup>*Ibid.*, p. 41.

<sup>27</sup>Muhammad, *Op.cit.*, p. 359

<sup>28</sup>*Ibid.*,

<sup>29</sup>Ibnu Taimiyah, *Majmu’ Fatawa, Op.cit.*, Vol. 29, p. 523-525 in Muhammad, *Ekonomi Mikro Dalam Perspektif Islam*, (Yogyakarta: BPFY-Yogyakarta, 2004), p. 359.

<sup>30</sup>Muhammad, *Op.cit.*,

assumption on market competition is unambiguous. Furthermore, he wrote “to force people to sell objects which are not obligatory to sell, or restrict them from selling a permissible object, are injustice and therefore, unlawful.”<sup>31</sup> In term of contemporary economy, it is clearly shows full freedom to enter or exit the market. Hereafter, he criticized collusion between buyer and seller.<sup>32</sup> The homogeneity and product standardization, explained by Ibn Taimiyah: “advocated in his condemnation of adulteration of the product and of fraud and deception in its presentation for sale”.<sup>33</sup> Ibn Taimiyah pointed the knowing of market and commodities, as well as sale and purchase contract, depends on approval and approval needs knowledge and understanding.<sup>34</sup>

Ibn Taimiyah opposed excessive regulation when market forces independently determines the competitive prices. With still consider imperfection market, he recommended if sellers hoard and sell for the higher price than normal price even people need the goods, so that sellers should sell it at equivalent price level. This concept synonymous with fair prices. Furthermore, if those are elements of monopoly (especially in market of foodstuff and other basic human needs), government should prohibit the monopoly power.<sup>35</sup>

In *Al-Hisbah fi al-Islam* explained about restriction of individual economic freedom in certain cases, including restriction on pricing of goods and services.<sup>36</sup> Ibn Taimiyah explained the restriction of economic freedom that individual is fully authorized to keep his property and no one can take other property without permission and agreement that justified, except in certain cases that clearly they should give it,<sup>37</sup> such as spending zakat from our property.

The implication of statement that Islam based on market mechanism are the doctrines of economic that proposed by Ibn Taimiyah as follows:<sup>38</sup>

1. People are free to enter and exit the market.
2. Good information about power and commodities that traded in the market is indispensable.
3. The elements of monopolistic should be removed from the market.
4. In case of this freedom, Ibn Taimiyah recognized the effects of increased demand and decreased supply to the prices.

---

<sup>31</sup>Ibnu Taimiyah, *Al-Hisbah, Op.cit.*, p. 41 in Muhammad, *Ekonomi Mikro Dalam Perspektif Islam*, (Yogyakarta: BPFE-Yogyakarta, 2004), p. 360.

<sup>32</sup>*Ibid.*, p. 25.

<sup>33</sup>*Ibid.*, p. 21.

<sup>34</sup>Muhammad, *Op.cit.*, p. 360.

<sup>35</sup>*Ibid.*,

<sup>36</sup>Ibnu Taimiyah, *Al-Hisbah, Op.cit.*, in Muhammad, *Ekonomi Mikro Dalam Perspektif Islam*, (Yogyakarta: BPFE-Yogyakarta, 2004), p. 375.

<sup>37</sup>Monzher Kahf, *The Economic Views of Ibn Taimiyah*, Unpublished Paper, 1976 in Muhammad, *Ekonomi Mikro Dalam Perspektif Islam*, (Yogyakarta: BPFE-Yogyakarta, 2004), p. 375.

<sup>38</sup>Muhammad, *Op.cit.*, p. 376.

5. Deviation from economic freedom practices on the level, such as perjury, incorrect scales and others. In addition, commodities that traded should follow the norms of Al-Qur'an such as commodities does not contain alcohol, prostitution and gambling.

Therefore, the conclusion is Ibn Taimiyah has clearly perception on market condition, that in market should exist honesty, transparency and freedom to choose the important formulation. So, it related to the appreciation and evaluation of the analyzing in relevance to the market and mechanism of price fixing.

## **6. Conclusion**

Market mechanism is a power that are mass (impersonal) and natural so that reflect condition of people's economy comprehensively. In a perfect competition market, there is no one may control the market. Appreciation of Islam on market mechanism according to the word of Allah said the transaction or commerce should be done in a good way based on the principle of mutual pleasure (*rida*) so that created fairness.

Market mechanism that be expected is an equilibrium among supply and demand which determine the prices, so that created normal prices in the market. The success of market mechanism is it can allocates factors of production efficiently and pushing up for the economic development.

Ibn Taimiyah has his clearly point of view on freedom market, which the prices determined by supply and demand power. Because market in Islam is an element that not operate itself so that it unite itself with individual, people and the state. All of those elements related each other and operate in combination to realize prosperity in the world and the hereafter. Islam recognizes market mechanism as long as it works with fair, equitable, mutual pleasure and there is no distortion. Generally, he showed the beauty of market (the beauty of market mechanism as a mechanism of economy), with all its shortcomings. For this reason, he denied the intervention to push and determine the prices (price intervention) so that will disturb the freedom mechanism. As long as rise and fall of supply and demand are caused by natural factor. However, we should realize that market mechanism will not always work perfectly, often the distortion will happen. Therefore, the intervention will be justified for a certain specific cases and also specifically.

## **REFERENCES**

Anto, Hendri, *Pengantar Ekonomika Mikro Islami*, Yogyakarta: Ekonisia, 2003.

At-Tariqi, Abdullah Abdul Husain, *Ekonomi Islam: Prinsip, Dasar dan Tujuan*, translated by M. Irfan Syofwani, Yogyakarta: Magistra Insania Press, 2004, First Edition.

Chamid, Nur, *Jejak Langkah Sejarah Pemikiran Ekonomi Islam*, Yogyakarta: Pustaka Pelajar, 2010.

Kahf, Monzher *The Economic Views of Ibn Taimiyah*, Unpublished Paper, 1976 in Muhammad, *Ekonomi Mikro Dalam Perspektif Islam*, Yogyakarta: BPFE-Yogyakarta, 2004.

Karim, Adiwarmanto, *Sejarah Pemikiran Ekonomi Islam*, Third Edition, Jakarta: PT RajaGrafindo Persada, 2012.

Muhammad, *Ekonomi Mikro Dalam Perspektif Islam*, Yogyakarta: BPFE-Yogyakarta, 2004.

Pusat Pengkajian dan Pengetahuan Ekonomi Islam (P3EI) UII Yogyakarta in collaboration with Bank Indonesia, *Ekonomi Islam*, Jakarta : PT RajaGrafindo Persada, 2012.

Riva'i, Veithzal dan Andi Buchari, *Islamic Economics : Ekonomi Syariah Bukan Opsi Tetapi Solusi!*, Jakarta : PT Bumi Aksara, 2009.

<http://shariaeconomics.wordpress.com/tag/mekanisme-pasar-dalam-perspektif-ekonomi-islam/> accessed on 25 June 2016.



**Topic :** Humanities

## **Deployment of a Digital Textbook Conforming to a Textbook**

YOSHIDA, Masami<sup>a,\*</sup>, TAKANO, Tsutomu<sup>b</sup>

<sup>a</sup>*Faculty of Education, Chiba University, Chiba, Japan*

<sup>b</sup>*Tokyo Shoseki Co. Ltd., Tokyo, Japan*

---

### **Abstract**

This article argues for digital textbook dissemination in Japan. Digital textbooks project was distinguished in its range, budget, dissemination, and involvement of schools among ICT education projects in Japan. In addition, it enclosed characteristics of 100% conforming to textbooks and curriculum. The results of detailed interviews with a publisher and extensive social factors were introduced to clarify the barrier and future role of digital textbooks. Some political and technological issues were identified to improve dissemination. In addition, we have become aware of communicating with foreign agents over differences in curriculum.

### **Keywords**

Digital textbook; Digital materials; Textbook publisher; International communication; Educational policy

---

## **1. Introduction**

The teachers' edition of digital textbooks were developed after revision of school curriculum in Japan. Digital textbooks for elementary schools, lower secondary schools, and high schools published in 2011, 2012, and 2013, respectively. These digital textbooks have mediated lesson materials involving not only the content of textbooks, but also audio/visual materials and simulations. Digital textbooks were designed to facilitate the following functions (Textbook Publishers Association of Japan, 2015).

- To provide easy to understand explanations
- To offer textbooks through using various modalities
- To improve students' lesson involvement

Subsequently, the students' edition was introduced in 2013.

So far, we have met various mediated materials in education, but the project regarding digital textbooks was distinguished in its range, budget, dissemination, and involvement. In addition, it enclosed characteristics of 100% conforming to textbooks and curriculum.

---

\* Corresponding author. Tel.: +81-43-290-2615; fax: +81-43-290-2615.  
*E-mail address:* yoshida-m@faculty.chiba-u.jp

Unfortunately, there are a limited number of international reports regarding diffusion of digital textbook in Japan, and this study summarizes current dissemination and acceptance of digital textbooks in schools. It also discusses the future of this field and possible international communication.

The methods included a review of documents and interviews at a publisher to collect concrete dissemination facts.

## 2. Specification and Variety of Digital Materials

The production and development of digital textbooks are not independent activities of publishers. CoNETS (Connecting to the next education for teachers and students) is a syndication of digital textbook publishers in Japan that has coordinated specification of digital textbook. The syndication covers 12 textbook companies among 42 textbook publishers. Although each digital textbook has characteristic component, the system of digital textbooks is similar. Then, we selected a leading publisher to know more details.

The following statements are based on the interview at Tokyo Shoseki Co., Ltd. (Takano, T., 2016).

### 2.1. *Digital textbooks*

Digital textbooks in the market are categorized as the following three types.

#### a) Digital textbook, teachers' edition

- Content development: HTML5, Java Script
- System data provision: DVD/ Download from a server of contracted organization (e.g. a rural education office)
- Terminal: Computer
- Measure for an infringement on copyright: Digital Rights Management (DRM)
- Monitor: LCD or Interactive white board (IWB: Wired and interactive display with a server controlled as well as white board function of more than 50 inch, 260 million IDR, installed as a standard lesson media in Japan, see Figure 1)



Figure 1. Interactive White Board

- Fee: DVD 9.5 million IDR/textbook (one time contract, selectivity rate 90%) or download (one year contract, selectivity rate 10%) 2.5 million IDR/textbook
- Functions: In addition to the digital view of a textbook, various tool buttons appear in the screen. The following statements are a list of familiar functions.
- Display
  - Enlarge contents
  - Change font

Read aloud with speed control  
 Transparency  
 Black and white reversal  
 Spot light (focusing)  
 Marker.

- Interactive
  - Over writing, hiding and moving
  - White board
- Informative
  - Link to animation or video
  - Web links
  - Link to digital dictionary
  - Visual contents list
  - Additional exercises
- Customize
  - Rearrange textbook contents
  - Insert photo
  - Slide show of selected parts

b) Digital textbook, students' edition, EPUB3 version

This version is distributed as a supplement of the teachers' edition

- Content development: EPUB3 (Same format as the International Digital Publishing Forum: IDPF)
- Terminal: Tablet
- System data provision: Download from a server of a school
- Functions: Mainly this offers display functions in teachers' edition.

c) Digital textbook, students' edition, digital materials version

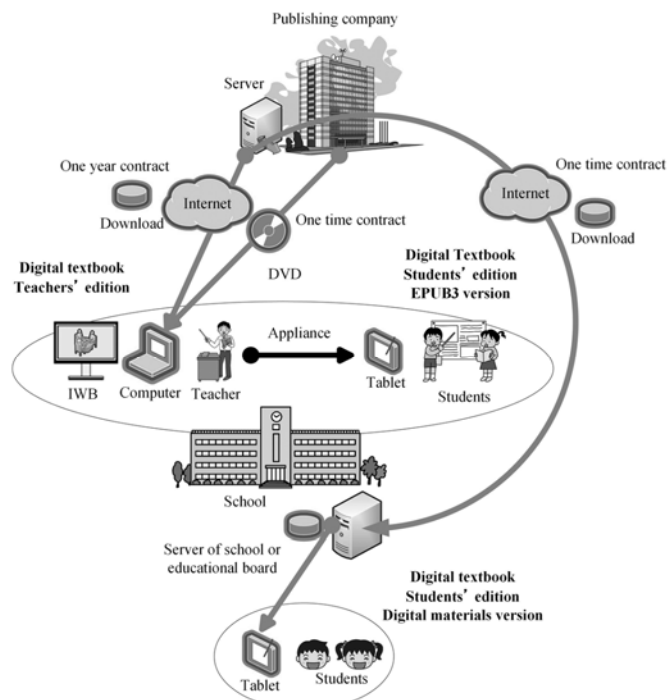

Figure 2. Distribution of Digital Textbooks

Content development: HTML5, JavaScript, This version includes digest of textbook contents.

- Terminal: Tablet or PC
- System data: Download from a server of contracted organization (e.g. a school or a rural education office)
- Functions: Digest of contents of teachers' edition.
- Fee: One year contract and cover all students of a subject, 2.5 million IDR/textbook

Figure 2 shows the variety of digital textbooks and methods of distribution.

## 2.2. Other digital materials in terms of a textbook

### a) Worksheet database

About 5,000 sheets for elementary schools and 5,000 sheets for lower-secondary school have been developed.

- Content development: PDF and word processor files
- Selectivity rate: About 22% of elementary schools and lower secondary schools.
- Functions: Worksheets for drill, exercises of essential items, achievement tests, follow up exercises, and applied exercises. Possible to customize items by a teacher in charge if needed.
- System data: Provide service via Web (see site view in Figure 3). Data are stored in a server of publisher. Content delivery network (CDN) service is used to improve access response.
- Fee: 8.7 million IDR/year per subject



Figure 3. View of web service site (left) and sample worksheet (right) of worksheets database

### b) Audio visual materials

There are 2,200 titles for elementary graders, and 1,500 titles for lower-secondary graders.

- Data: Data are stored on a server at the school (see Figure 4).
- Fee: 12-25 million IDR/grade per subject (one time contract)

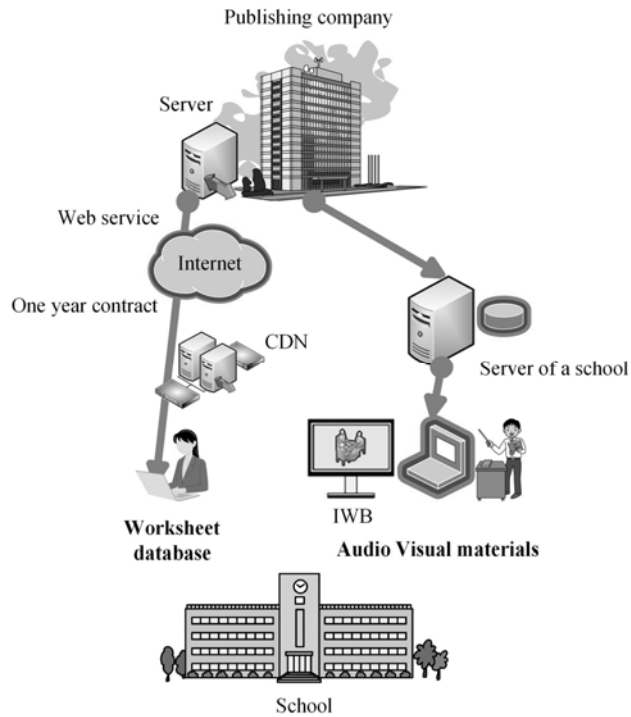

Figure 4. Other Digital Materials

Figure 4 shows the other digital materials and way of distribution.

### 3. Facts in Schools

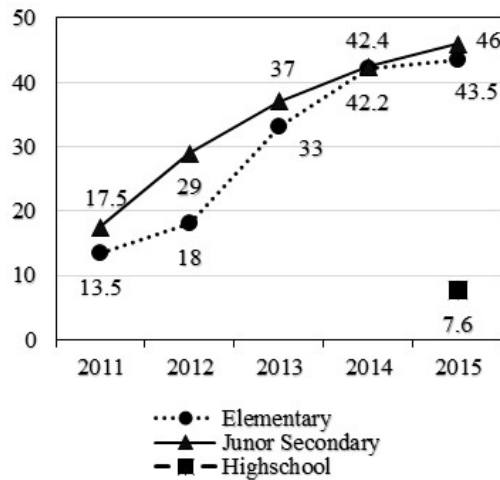

Figure 5. Dissemination Rate (%) of Digital Textbooks.

The Internet penetration rate in Japanese schools is 100%. All schools can introduce online services.

The dissemination rate of all digital textbooks is shown in Figure 5 (Textbook Publishers Association of Japan, 2015). The data show the rate of schools adopting digital textbooks. However, data from the dominant digital textbook show that the actual commercial product is uncovered. However, the digital English textbook in lower secondary schools has been adopted most frequently—it reached 30% of schools based on interviews with a leading publisher. This publisher has about 55% of the textbook market share (Takano, T., 2016).

### 3.1. *Benefit to use digital textbooks*

Reported benefit to use digital textbooks as described by the publishing company include (Takano, T., 2014):

- 1) Concrete explanations. They turn their eyes more from a desk toward a teacher.
- 2) Increase concentration on a main point of discussion.
- 3) Introduce a new mode of explanation via moving arrows on the screen.
- 4) Introduce a dynamic iconic view to embed arrows. This involves psychographic images of moving, action, changing, and depth of focus.
- 5) A tablet with a sensor can introduced for real time analysis. Augmented reality (AR) functions can also be included (see details in 5.1).

On the other hand, teachers' opinions of Genesis digital textbooks were also reported (National Institute for Educational Policy Research, 2012). As a result, only one percent of teachers had used a digital textbook, and their potential opinions of digital materials were analyzed based on the following four factors.

- 1) Digital materials are useful to develop highly integrated lesson materials.
- 2) Digital materials can offer cues on lesson planning that needs to be developed.
- 3) Digital materials enhance motivation to study the content.
- 4) Known benefits to using digital materials materialize.

On these grounds, digital textbooks and digital materials are effective at improving lesson preparation.

## **4. Barrier for Dissemination of Digital Textbooks**

It has been five years since digital textbooks were installed, but dissemination rates are still increasing slowly. This is because of the following issues.

### 4.1. *Governmental promotion*

The Ministry of education, culture, sports, science and technology (hereinafter MEXT) operate an educational project regarding ICT in education (MEXT, 2015). However, a concentration on disseminating digital textbooks remains unclear, and the size of the total budget is insufficient to cover digital materials that are installed at all schools.

The budget plan for promoting learning using ICT is 114 billion IDR.  
The breakdown of this is as follows.

- Project to promote the educational use of ICT: 21 billion IDR
- Project to support rural governments to enhance ICT education: 37 billion IDR
- Project to investigate and maintain educational quality via ICT in depopulating societies: 18 billion IDR

- Project to develop progressive educational management system: 16 billion IDR
- Project to measure the effect of harmful environments on youth: 16 billion IDR
- Other projects: 7 billion IDR

#### 4.2. *Anticipated challenge*

The following statements show the upcoming challenges to dissemination.

- Promotion: Educational policy to introduce digital textbooks
- Infrastructure: Congestion control is a problem when a teacher uses classroom techniques in a computer room. It is particularly difficult to access audio-visual contents in cyberspace by all students at the same time.
- All textbooks in Japan are authorized by MEXT. Screening systems are approved only in the paper version, but the guidelines only authorize digital textbook after an argument (Impress Corporation, 2016).
- Law: There should be laws for exceptions to copyright or extravagant contracts for digital textbooks (MEXT, 2016). In addition, the current law can only cover the cost of paper textbooks in compulsory schools. Therefore, the meeting of the Investigative Commission for Digital Textbooks of Student Edition reluctantly proposed that cost of digital textbooks should be covered by a guardian (Asahi Interactive, 2016; Nikkei Inc., 2016).
- Consensus: Digital textbooks require a new pedagogical viewpoint. Tamura, Y. (2014) reviewed the following warning of instruction using digital textbooks.
  - 1) Learning becomes standardized
  - 2) Learning is only focused on getting the right answer.
  - 3) Because the opportunity to write disappears, students' ability to write decreases.
  - 4) The communication between a teacher and students stops.
  - 5) It is difficult to judge the answer with plural solutions such as a proof.
  - 6) Immediate feedback, namely, the game sense, disturbs the development of intellectual thinking.
  - 7) Programmed learning does not improve intellectual thinking and decision-making.

#### 4.3. *Consideration on the use of digital textbook in foreign countries*

The following record is a summary of interviews from a manager of ICT department in a publisher (Takano, T., 2016).

- There are fatal differences in academic explanations among countries. This requires studies of the similarities and differences.
- Math: The contents of elementary 1st grade is nearly the same, but many difficulties are seen after the 2nd grade.
- The appropriateness of visual contents is not adaptable among countries—especially in science, health and physical education, and world geography.
- It is difficult to extend copyright—especially visual contents.
- Translation of the digest would be possible for foreign educators.
- Digital textbooks can contribute to Japanese-language training.

Now, exchange and sharing educational digital contents are used including activities of open educational resource (OER); however, the introduction of our experience and know-how to develop a qualified textbook are another possible area of international communication. Thus far, an investigated publisher has the following cases of technical transfer with international agents.

These include: India (content production), Saudi Arabia (qualified printing for textbook), Vietnam (technical transfer of textbook development system), Mongol (development of digital materials), China (online content delivery and publishing) and Egypt.

On the other side, the publisher has used offshore production in China, Vietnam, and Taiwan. Thus, the production of textbooks and materials are expanding.

## 5. Future View

### 5.1. Textbook AR (Augmented Reality)

After installing APP in a tablet or smartphone, audio/visual information appears when a student holds a tablet over the textbook (see Figure 6). A student can learn more details of the subject area knowledge or have an interactive mode of trial (Kyoiku Katei Shinbun Co., 2015).

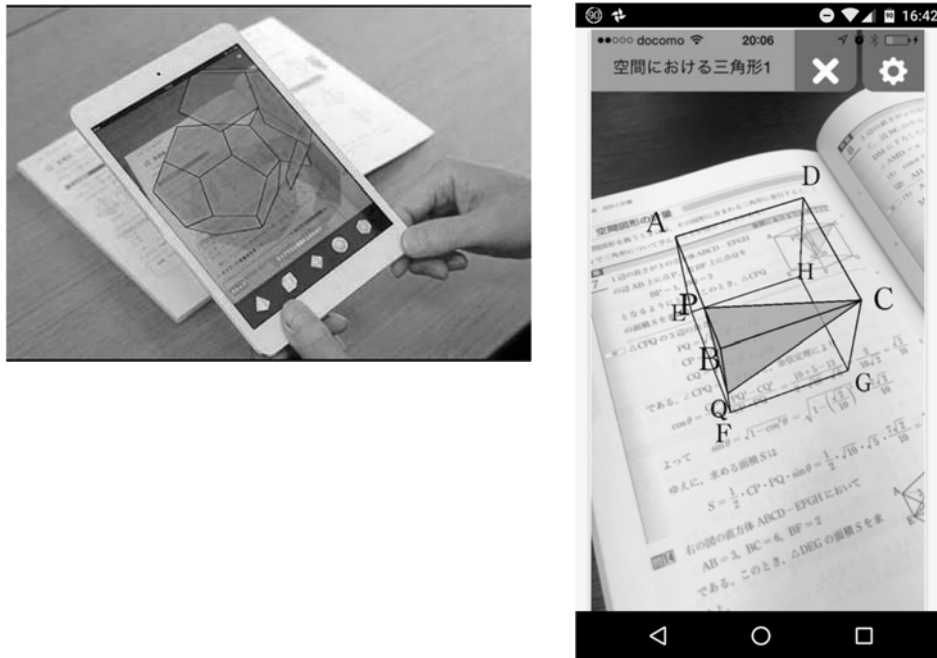

Figure 6. View of Textbook AR.  
(Cited from Tokyo Shoseki Co., 2015)

### 5.2. Space for free writing

In the students' edition, the following activities are under development: annotation (add free writing into contents); spacing (insert space under exercise); popup (create a new page during an exercise); and automated recording of their writing. (Kobayashi & Kato, 2016).



### 5.3. *Participative digital textbook*

Communicative functions for the teachers' edition have emerged. This allows teachers to upload their photo into a cloud, and the system arranges data in a service site with positioning data of GPS (The Education Newspaper, 2015).

In addition, the function of collection of learning history, cloud computing, collaborative learning, and automated disaster alert are in the trial stage (JAPET, 2013; NTT Communications Co., 2013); however, these are not ready to be standard because of security reasons (Uchida Yoko Co., Ltd, 2014).

## 6. Final Remarks

It is known that the media has no effect on student outcomes. Student outcomes involve the quality of the curriculum materials, instructional method, and student learning preferences (Western Interstate Commission for Higher Education, 2010).

For instance, we know that car navigation systems are convenient. While, we could still reach our destination with a paper map, the media decreases our stress and lets us focus on driving. Similarly, digital textbooks offer the same influence—they allow students to focus on learning.

## Acknowledgment

This study was developed based on our report at the Seventh International e-Learning Conference organized by Ministry of Education, Thailand on 28th July, 2016 (Yoshida, M. and Takano, T., 2016).

## References

- Asahi Interactive, Inc. (2016). Ministry of education, culture, sports, science and technology will introduce "digital textbook" by placing the burden on a guardian. Retrieved from <http://goo.gl/E86bHE>
- Impress Corporation. (2016). News: Problems and future of "digital textbook." From the symposium of the association of digital textbook & teaching. Retrieved from <http://goo.gl/hzJ9QO>
- JAPET. (2013). Investigational study on using advanced ICT in educational area, 2013 (pp. 141). Tokyo: Japan Association for Promotion of Educational Technology.
- Kobayashi, N., & Kato, N. (2016). A model of digital textbooks for learners. For the activity writing in textbook and the problem of official approval. IPSJ SIG Technical Report, 2016-CE-134(10), 1-8.
- Kyoiku Katei Shinbun Co. (2015, July 6). To master formulation competence through difficult exercise of mathematics, Kyoiku Katei Shinbun, p. 3.
- MEXT. (2015). Major items of the budget request plan for 2016 fiscal year. Tokyo: MEXT Retrieved from <http://goo.gl/1hftU8>.
- MEXT. (2016). Summary of points of discussion for midterm report, Retrieved May 18, 2016, from <http://goo.gl/3rwWuN>
- National Institute for Educational Policy Research. (2012). Investigation of situation for installation and use of digital materials. Retrieved from Tokyo: <https://goo.gl/s18Z2x>
- Nikkei Inc. (2016). "Digital textbook" will be introduced in 2020. Expert committee proposed a plan. Retrieved from <http://goo.gl/Gv5IRf>
- NTT Communications Co. (2013). Outline of the tryout project regarding learning and educational system to use advanced information and communication system technology such as cloud. NTT Communications Co. Tokyo.

- Takano, T. (2014). Present and future view of digital textbook. *Activities of Tokyo-Shoseki Co., LTD. Computer and Education*, 36, 25-29.
- Takano, T. (2016) Situation of dissemination of digital textbook/Interviewer: M. Yoshida.
- Tamura, Y. (2014). Status of digital textbooks. *Journal of Information Processing and Management*, 57(5), 307-314.
- Textbook Publishers Association of Japan. (2015). Present situation and issues of digital textbook. Retrieved from <http://goo.gl/ikGwai>
- Tokyo Shoseki Co., Ltd. (2015). Introduction of textbook and syllabus. Introduction of "textbook AR". Retrieved from <https://goo.gl/WGaEku>
- The Education Newspaper. (2015, May 14). Participative digital textbook. Allowing teachers to upload their photos to Web. *The Education Newspaper*. Retrieved from [https://www.kyobun.co.jp/education-ict/20150514\\_01/](https://www.kyobun.co.jp/education-ict/20150514_01/)
- Uchida Yoko Co., Ltd. (2014). "Investigational study to promote effective use of ICT in education areas." from <http://goo.gl/c6g1ef>.
- Western Interstate Commission for Higher Education. (2010). No significant difference. Retrieved May 15, 2016, from <http://goo.gl/g10W6l>
- Yoshida, M. & Takano, T. (2016). Overview of Digital Textbooks in Japan, Paper presented at The Seventh International e-Learning Conference 2016. *Disruptive Innovations in Education*, July 28-29th (Presentation on 28th), at Bangkok International Trade and Exhibition Center: Bangkok, Thailand, Program P.2.

**Topic:** Education

## **An Inquiry into the Meaning-Making Process of Japanese Learning in Higher Educational Institution in Indonesia**

Fatmawati Djafri\*

*Waseda University Graduate School of International Culture and Communication Studies,  
1-6-1 Nishiwaseda, Shinjuku, Tokyo 169-8050, Japan*

---

### **Abstract**

Over the past ten years, Indonesia has become one of the countries in the world with significant increasing number of Japanese learners. The recent survey of Japanese education overseas conducted by Japan Foundation in 2012 pointed out Indonesia as the country with the second largest Japanese learners after China. It indicates the indisputable fact that Japanese has become a language of considerable significance in foreign language education in Indonesia. Furthermore, the growing bilateral cooperation and the spread of Japanese pop cultures also give a great influence. Many young people, especially in high schools, are motivated to study Japanese and eager to continue their study to higher educational institutions. In accordance with it, many Japanese departments were established in universities across the country.

This paper discussed two studies conducted in an Indonesian university to explore affective factors constituted in the meaning-making process of Japanese learning in higher educational context. The first study was conducted using quantitative method to examine foreign language anxiety and its relation to motivation and learners' perception of teachers' behaviours among learners of five foreign language majors, namely Japanese, Korean, Arabic, French, and English. Results indicate Japanese learners tend to have higher anxiety associated with classroom procedures. The second study was conducted using narrative inquiry to investigate the process of motivational change among Japanese learners. These studies proposed some key roles Japanese department as a higher educational institution plays in fostering global human resources. The implications provide important insights into foreign language education planning in Indonesia.

### **Keywords**

*higher educational institution; Japanese learners; foreign language anxiety; motivational change; meaning-making.*

---

## **1. Background**

Surveys on Japanese language education overseas conducted by The Japan Foundation since 1974 has always shown constant increase of Japanese language learners in Indonesia. Particularly since 2000s, there was a rapid growth of Japanese learners, from 85,221 learners in 2003 to 272,719 learners in 2006 (Furukawa, Kitani, & Nunoo,

---

\* Corresponding author. Tel.: +81-80-3695-1980. E-mail address: fatmawati.djafri@akane.waseda.jp

2015). Furthermore, the latest survey conducted in 2012 even shows an astounding fact, that is Indonesia has reached 872,411 learners and by this, Indonesia has become the second country in the world after China with the largest number of Japanese learners. The number has increased 21.8% from the data collected in 2009 survey. It indicates the growing needs of Indonesian people to learn Japanese language and in order to meet the demand, many Japanese language institutions in second and higher educational level were established, increased 18% in three years since 2009 (The Japan Foundation survey, 2013). During the period of 1995-2005, based on the long-term higher education development plan of the Indonesian government, many undergraduate and graduate program of Japanese language were established in universities across the country (Furukawa, Kitani, & Nunoo, 2015). The growing bilateral cooperation and the expansion of Japanese industries into Indonesian market are among factors that play significant roles in the rapid growth of Japanese language learners and institutions in Indonesia. After the ratification of Indonesia-Japan economic partnership agreement (EPA) in 2008, the flow of investment, goods, and people between the two countries was enhanced even more. According to the survey conducted by Teikoku Data Bank (TDB) in 2014, there were 1,763 Japanese companies established in Indonesia, increased 39.3% compared to the data in 2012 survey.

However, The Japan Foundation surveys also demonstrated the increasing number of unenthusiastic Japanese learners who show little or no interest in learning Japanese. According to the survey, especially in the Southeast Asian countries, the problem of insufficient interest has provoked significant responses. Similarly, among problems Japanese language educational institutions in Indonesia are dealing with, insufficient interest among learners and declining number of learners are constantly increasing in 2006, 2009, and 2012 surveys. As well as in general context, higher educational institutions were also facing the similar problems as shown in the table below.

Table 1. Problems of Japanese language education in Indonesian higher educational institutions (from the Japan Foundation survey of overseas Japanese language educational institutions)

Problems	2006	2009	2012
Insufficient interest among learners	12.2%	27.1%	33.1%
Declining number of learners	22.6%	27.8%	28.6%

There are some particular social contexts in which this phenomenon took place. In Indonesia, we still find general opinion saying that foreign language learning does not have a good prospect in the future, and there are people who choose to study foreign language in university as the last option after failing university entrance national exam (hereinafter national exam). Majoring language studies in university is seen as less promising option in the future compared to other majors such as medical, engineering, or economics studies. Nevertheless, graduating from higher educational institution is considered to be a bridge to the future employment and participation in the society, regardless the major. Therefore, when one could not enter his/her priority major, he/she would choose language studies major in order to be able to study in the university to get a graduation diploma. However, in reality, studying language is not an easy task as they have imagined before. Being a Japanese learner and then Japanese teacher in university, the author frequently observed cases where learners were anxious about their language ability and performance inside language classroom. In some cases, they even decided to quit in the middle of the course.

To get a better understanding of the apparent paradox of the circumstances mentioned above, a comprehensive study of how affective factors, such as motivation and

foreign language anxiety (hereinafter FLA), influence Japanese language learning in Indonesian higher educational context is indispensable, not to mention study focusing on learners' voice inside and beyond the classroom. Furthermore, study on how learners made meaning of their language learning is of considerable significance in the field, especially when we are aiming for the improvement of Japanese language education in Indonesia. To pay more attention to learners' voice and their language learning experience is an issue of great importance. Therefore, two studies were conducted using quantitative and qualitative approaches. Each studies would be further explained in the next section.

## 2. Study 1

Study 1 focused on the anxiety in learning a foreign language experienced by Indonesian university students. How FLA has come into the spotlight was triggered by phenomena observed by the author, both as learner and then teacher of Japanese language at an Indonesian university. The author has seen many cases in which learners of Japanese language experience some signs of anxiety inside the classroom. The signs were similar with those summed up by Oxford (in Yanling & Guizhen, 2006) as FLA signs:

- General avoidance: "forgetting the answer", showing carelessness, cutting class, coming late, low level of verbal production, lack of volunteering in class, seeming inability to answer even a simplest question.
- Physical actions: squirming, fidgeting, displaying jittery behaviours, being unable to reproduce the sounds or the intonation of the target language even after repeated practice.
- Physical symptoms: complaining about headaches, experiencing tight muscles.
- Other signs of anxiety in which may reflect cultural differences: over-studying, perfectionism, social avoidance, conversational withdrawal, lack of eye contact, image protection or masking behaviours (exaggerated smiling, laughing, nodding, joking).

MacIntyre & Gardner (1994) define FLA as the feeling of tension and apprehension specifically associated with second language contexts, including speaking, listening and learning. It is a universal phenomenon found not only in English language (Sila, 2010), but also in other languages as well, such as Spanish (Noels, 2001), French (Rodríguez & Abreu, 2003), and less commonly taught languages, such as Arabic (Elkhafaifi, 2005) and Japanese (William & Andrade, 2008). Furthermore, the unfamiliar writing and phonological systems found in less commonly taught languages appear to produce greater anxiety in learning compared to the commonly taught ones (Elkhafaifi, 2005). Factors influence FLA are both internal and external, including learners' motivation (Bandura, 1997) and their belief in second language acquisition (Horwitz, Horwitz, & Cope, 1986), as well as those derived from the environment, such as teacher's teaching styles and the relationship with learners (Noels, Clément, & Pelletier, 1999). This study intended to examine how FLA relates to learners' motivation and their perception of teacher's behaviors and to investigate the interaction between these variables within the foreign language classroom context.

### 2.1. Research Design

The purpose of study 1 was to examine the level of FLA among Indonesian undergraduate learners of Japanese, Korean, Arabic, English, and French. Furthermore, the study intended to see whether it is related to learners' motivation and their perception of teacher's behaviours inside the classroom.

There were 5 research questions (hereinafter RQ) in this study. (RQ1) To what extent FLA manifested in learners of five different foreign languages? (RQ2) Is there differences in FLA level between alphabet languages group and non-alphabet language group? (RQ3) Do learners' motivation and their perception of teacher's behavior simultaneously affect their FLA experiences? (R4) Does learners' motivation affect their FLA? (RQ5) Does learners' perception of teacher's behavior affect their FLA?

There were 3 main instruments used in this study. The first instrument was Foreign Language Anxiety Scale, adapted from Foreign Language Classroom Anxiety Scale (FLCAS) constructed by Horwitz, et. al. (1986). The scale consists of 34 items with item-total correlation coefficients ranging from 0.303 to 0.696, and alpha reliability coefficient 0.933. The second instrument was learners' motivation scale, adapted from Language Learning Orientation Scale (LLOS) constructed by Noels, Pelletier, Clément, & Vallerand (2003). The adaptation version consists of 22 items with item-total correlation coefficients ranging from 0.301 to 0.569, and alpha reliability coefficient 0.866. The third instrument was learners' perception of teacher's behaviors scale. It was adapted from instruments used in two previous studies, the instrument to measure the perception of teacher's communication styles (Noels, et. al., 1999) and the instrument to investigate the relation between teacher's behaviors and learners' intrinsic motivation (Pelletier & Vallerand, 1996). The modified version consists of 9 items with item-total correlation coefficients ranging from 0.453 to 0.663, and alpha reliability coefficient 0.845. Along with these three instruments, the participants were asked to fill open-ended additional questions and background information concerning their language learning.

Participants were undergraduates of Japanese language program of an Indonesian university who were in second year of their four-year study program. There were a total of 182 participants, consist of 30 English learners, 47 Japanese learners, 32 Arabic learners, 43 French learners, and 30 Korean learners. The questionnaires were distributed in the end of each language classes. After the explanation of the study and informed consent form by the author, participants were asked to fill out the questionnaires.

## 2.2. Findings and Discussion

The data was analyzed using 3 methods of analysis. To answer RQ1, one-way ANOVA was applied. The mean scores showed that Japanese learners has the highest level of FLA (100.30), followed by Arabic (92.59), French (91.63), Korean (90.30), and English (83.07) learners. Furthermore, significant difference was apparent between Japanese and English learners' sample groups ( $p=0.000$ , mean difference=17.231) after the analysis using post-hoc test. RQ2 was analyzed using independent sample T test, and the result showed there is a significance difference between alphabet language sample group and non-alphabet language sample group, in which the latter (mean=95.28) has higher level of FLA compared to the former sample group (mean=88.11).

To analyze the relationship between FLA, learners' motivation and their perception of teacher's behaviors in RQ3, RQ4 and RQ5, multiple regression analysis with backward method was applied. Learners' motivation variable was removed in model 2. The result suggested that learners' motivation and their perception of teacher's behaviors are not simultaneously affect their FLA (R square value=0.026,  $p=0.095$ ). While in model 1 where learners' motivation was included, the coefficient for this variable had  $p$  value=0.863, while learners' perception variable has  $p$  value=0.035. This indicated that the latter significantly affects FLA, while the former do not determine FLA. The analysis of additional open-ended questionnaires also showed teacher-related situations is the biggest cause of FLA, followed then by class-related situations in all sample groups, except

English learners' group. However, all sample groups shared similarity of their perceived ability in anxious classroom environment. They perceived their language ability as being in average or low level when they get anxious while learning language in the classroom.

The findings of the study confirm that Japanese learners have the highest FLA level, followed by Arabic, French, Korean, and English learners. Different writing system of Japanese, including the application of three different kinds of characters at the same time, and the gradual increasing of difficulty as the learners move to intermediate and advanced level, are some factors contribute to it. There is also a difference in foreign language anxiety levels between alphabet (English and French) and non-alphabet (Japanese, Korean, and Arabic) languages group, in which the non-alphabet one has a greater anxiety level. Besides the different writing system factor, the fact that English is the most common foreign language learned in Indonesia, in which many English learners are also engaging in informal English language institutes, might be one of the factors that makes English learners less anxious compared to other foreign language learners.

Learners' motivation and their perception toward teachers' behaviours do not simultaneously affect FLA of Indonesian undergraduate students. As a matter of fact, it shows only a very small contribution to FLA. Furthermore, learners' motivation in language learning is not a predictor FLA of Indonesian undergraduate students. One of the explanations for it is that the external factors, for example classroom environment, give bigger influence than the internal one, such as motivation, for most Indonesian learners. On the other hand, learners' perception of teachers' behaviours is one of the predictor for FLA of Indonesian undergraduate students. The explanation is similar with the previous one, especially among Japanese learners, in which almost half the those participated in the study attribute teacher's behaviours as the source of their anxiety inside foreign language classroom. The learning procedures and environment inside the classroom also contributes to the occurrence of learners' FLA.

### 2.3. Conclusion

This study proposed some recommendations for further research of FLA and for foreign language teaching practitioners. Teachers, especially in Japanese classroom, need to assess their approach in error correction as well as their behaviours toward learners. This study also found that teacher's behaviours, such as discouraged comments and harsh manner in correcting learners' language errors, over-dominating inside the classroom, and inflexible teaching method that make it hard to understand the materials, were related to a higher level of FLA. Young (1991) suggested that teachers need to be more friendly, relaxed and patient, made learners feel more comfortable, encourage them to speak out, and emphasize that mistakes are part of language learning process. Teachers can do more pair work or small group work and language games to reduce FLA. Working in pairs or small group provides a lot of opportunity for learners to practice their foreign language, to help each other, and to gradually build their self-confidence in speaking in front of others.

Study 1 was conducted using quantitative approach and were able to determine the tendencies of foreign language learners inside foreign language classroom. However, much less is known about the changing process of learners during their study in the university and how it relates to social and cultural contexts beyond the foreign language classroom, especially Indonesian Japanese learners who have shown higher level of FLA compared to other foreign language learners. For that reason, study 2 were designed to be conducted in a qualitative manner, as further explained in the next section.

### 3. Study 2

Study 2 was conducted to investigate the motivational change and the meaning making process of Japanese learning experienced by Indonesian Japanese learners who were majoring Japanese language program at an Indonesian university. This process was analysed based on Dörnyei's (2005, 2009) L2 (second language) Motivational Self System. There are three components in this theoretical framework: (1) Ideal L2 Self (the image of self who can speak L2 one would like to become), (2) Ought-to L2 Self (the image of self in which one believes one ought to become to meet others' expectations or to avoid possible negative outcomes), and (3) L2 learning experience (related to learning environment and experience). This study aimed to understand the dynamics process of learners' identity construction and negotiation through the interaction between their ideal and ought-to selves with their learning experiences during their Japanese study in university. Therefore, 3 RQs were developed in the study. (RQ1) How did learners' motivation change? (RQ2) What factors did influence the change? (RQ3) How did this change relate with the image of learners' future L2 self?

In order to grasp the sociological aspect of the motivational change, the concept of 'investment' proposed by Norton (1995) was also taken into consideration. It argues that *"If learners invest in a second language, they do so with the understanding that they will acquire a wider range of symbolic and material resources, which will in turn increase the value of their cultural capital. Learners will expect or hope to have a good return in that investment, a return that will give them access to hitherto unattainable resources"* (Norton, 1995: p.17). It is important to incorporate Norton's view of investment into the analysis since we are inclined to see learners from dichotomous point of view: motivated/unmotivated, good learner/bad learner, etc. The framework of 'investment' argues that language learners' motivation, anxiety, and self-confidence related to language learning process need to be understood as parts of learners' relationship to larger social structures (Norton, 2013: p. 156). They are socially constructed in learners' experiences, connected to their changing identities and desire for the future.

#### 3.1. Research Design

To get a better understanding of motivational change and the meaning making process in Japanese learning, qualitative method using narrative inquiry was considered to be the most suitable approach for data collection. The participants who agreed to be interviewed were 17 Japanese learners in their last year of study at university. In-depth semi structure interviews followed by questionnaires of participants' background information were conducted and the collected data were then transcribed and coded. Based on initial motives for learning Japanese in university, participants were divided into 2 general groups: those who decided to enter Japanese program because they have failed national exam and those who enter because of the interest in learning Japanese. Furthermore, there were 5 categories emerged from the data: (1) future self-image integrated with Japanese, (2) difficulties in learning Japanese, (3) conflict of selves, (4) support of others, and (5) expanded network.

#### 3.2. Findings and Discussion

The result found that among 17 participants, 8 of them chose to continue their higher education in Japanese major because they have failed national exam and because of the scholarship opportunity. The interviews further show that they preferred other majors when they applied for national exam. Japanese major has been a save second or last choice for them in order to be able to enter university. Moreover, the influence of family



members, especially parents, and close friends who are already studying Japanese or went to Japan, as well as their high school Japanese teacher is of considerable significance in their decision in choosing Japanese major. The result is similar with the research conducted by Kobari (2014) who also shows significant number of learners with similar motivations as mentioned above in choosing Japanese language education major in university.

Further analysis of in-depth interviews pointed out 5 learners: Sheila, Santi, Isti, Adel, and Dedi (all pseudonyms), who went through a notable motivational changes over their three-year period of study. Sheila, Santi, and Isti are among those 8 participants, meanwhile Adel and Dedi are among other group of participants whose great interest in anime and manga have motivated them to choose Japanese major in the first place and turn down other offers. From the analysis of their stories as well as other participants, 5 categories as mentioned earlier were emerged and become important factors in the dynamic process of motivational change. The process itself were divided into three stages: (1) the initial stage, where learner starts to learn Japanese in university, (2) the confirmation/practical stage or the anxious stage, where learners begins to question the further meaning of their Japanese learning, and (3) the development stage or the withdrawal stage, where learner decides what to do with their further investment in Japanese learning. Furthermore, the changing from one stage to another is caused by what the author called “turning point”. The first turning point marked the changing process from the initial stage to the confirmation/practical stage or the anxious stage, and the second turning point marked the changing process from the confirmation/practical stage or the anxious stage to the development stage or withdrawal stage.

In the cases of Sheila, Santi, and Isti, they have various motivations when they started to learn Japanese in university. Sheila without background of Japanese learning felt the urgency to keep up with her classmates and get good grades. Santi who failed the national university entrance exam is motivated because of her interest in anime, manga and J-Pop since her teen years. Meanwhile Isti needed to maintain her good grades for the sake of scholarship. Japanese was easy in the beginner level for them and somehow they still could manage the difficulties in learning Japanese. Support from families and their best friends also motivated them to keep going.

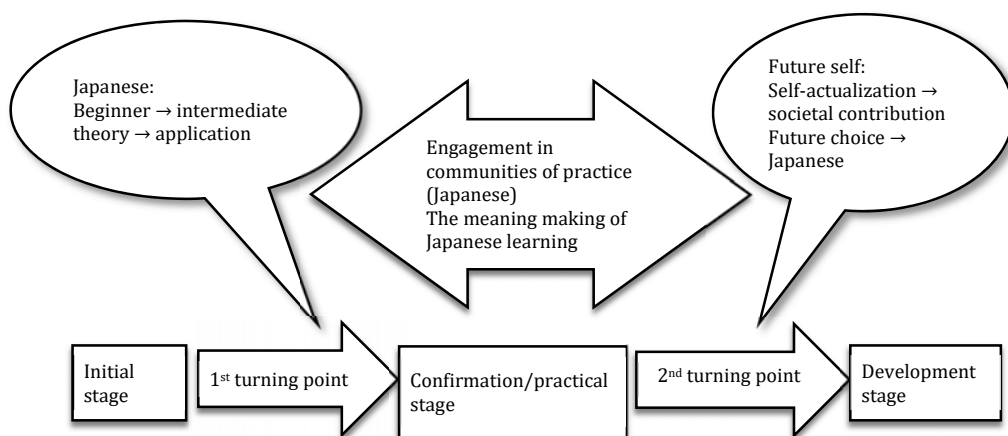

Figure 1. The process of motivational change experienced by Sheila, Santi and Isti

However, the transition from beginner to intermediate level, followed by the application of theoretical Japanese, become the first turning point for them in thinking

more about the meaning of their Japanese learning. The ought-to L2 self who is required to have the necessary Japanese capability to deal with intermediate level is in conflict with the real L2 self who is still lack of Japanese skills and the ideal L2 self as a competent Japanese learner. Some strategies learners applied in this stage are by practicing their Japanese through engagement in expanded networks with communities of practice and by measuring and confirming their Japanese proficiency through Japanese Language Proficiency Test (JLPT). This stage is significant for learners because it enables them to engage in the meaning making process of their Japanese learning, to connect their learning with those other than themselves, and to reconstruct their own identity within those new connections. This also prepares them to the development stage where they could develop the more concrete image of their future L2 self. As they prepare for future course after graduation, self-actualization related to societal contribution with Japanese as intermediary is being integrated into their future L2 self. For Sheila, her future L2 self is to become member of Japanese translator's community with competent Japanese skills, especially in grammar and Kanji. For Santi, it is to be able to pursue new field of study in Japan by utilizing her Japanese skills. While for Isti, her future L2 self is to become a competent Japanese teacher and for that reason, she wants to continue her study to higher level of education, especially related to Japanese language education.

Meanwhile in the case of Adel and Dedi, both have turned down other opportunities of learning in order to pursue their interest in anime and manga by enrolling in Japanese studies in university. They were highly motivated learners of Japanese in the initial stage of their learning. Up to this point, the Japanese learning was very much related with their own interest. However, the similar turning point as experienced by Sheila, Santi and Isti also happened to them. The shift from beginner to intermediate level has triggered them to engage in the meaning making process of Japanese learning. The difference is on their expanded networks of communities of practice they participated in. Adel actively participated in an international event with people from various countries, including Japan. Still, the required competence in this community of practice was not Japanese, therefore Adel was encouraged to practice other skills. The interaction with different fields and people somehow has made her reflect on her own Japanese skills and how she would be able to actively participate in the future society. She doubted her lack of Japanese skills would be sufficient for her future. This leads her to withdrawal stage where she decided to take another course after graduation. The similar case also happened to Dedi who in the end came to the conclusion that his Japanese skills is only for his self-interest and he needs to acquire other skills to be able to contribute to the future society.

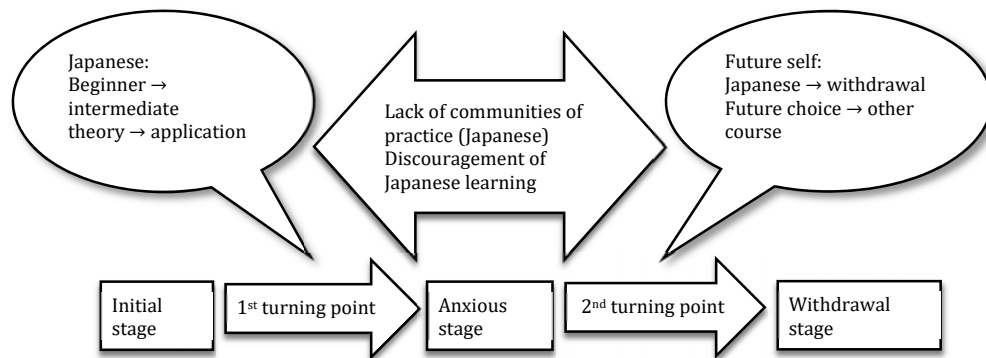

Figure 2. The process of motivational change experienced by Adel and Dedi

### 3.3. Conclusion

From the analysis of learners' motivational change during their three-year of study in university, it is inferred that learners' investment in Japanese learning is greatly related with learners' identities and their perception of Japanese as symbolic capital. The stories of five learners described above show that becoming the member of wider L1 (first language) and/or L2 societies who has access to resources such as employment and professional status is one thing that make learners invest in Japanese learning. This investment is expected to increase the value of their symbolic capital and open more access to resources of their desire and future L2 self. In other words, it reflects the meaningful connection between learners' commitment to learn language and their changing identities (Norton & Toohey, 2011). Furthermore, the study also found the significance of the meaning making process through participation in communities of practice related to Japanese language. The negotiation of meaning involves participation as a member of community of practice and reification as the process to make something more concrete through practice (Wenger, 1998). As learners made meaning of their own learning, Japanese gradually becomes integrated with their self, a process of what Wertsch (1998) refers to as "appropriation".

Based on the findings, this study proposed some significant points higher educational institutions should focus on, in order to encourage and facilitate learners' development, such as to make a connection between Japanese learning and the future, and to realize the importance of future imagination for learners to help them making their investment in language learning. Other suggestions are to foster learners' capacity to have multiple future options and to be able to choose the most relevant one, as well as to provide opportunity to get connected with various communities of practice.

### References

- Bandura, A. (1997). *Self-Efficacy: The Exercise of Control*, W.H. Freeman and Company, New York, United States.
- Dörnyei, Z. (2005). *The Psychology of the Language Learner: Individual Differences in Second Language Acquisition*, Lawrence Erlbaum, Mahwah, New Jersey.
- Dörnyei, Z. (2009). The L2 Motivational Self System. In Z. Dörnyei & E. Ushioda (Eds.) *Motivation, Language Identity and the L2 Self*, pp. 9-42. Bristol, UK: Multilingual Matters.
- Elkhafaifi, H. (2005). Listening Comprehension and Anxiety in the Arabic Language Classroom. *Modern Language Journal*, Vol. 89, No. 2, pp. 206-220. Wiley-Blackwell, United States.
- Furukawa, Y., Kitani, N., & Nunoo, K. (2015). Indonesia no Koukou Daigaku Nihongo Kyoushi e no Shitsumonshi Chousa ni Miru Nihongo Gakushuu no Imizuke no Henka [Changes in the Meaning of Japanese Learning as Seen from Questionnaire Survey of Indonesian High Schools' and Universities' Japanese Teachers]. *The Japan Foundation Bulletin of Japanese Education*, No. 11, pp. 7-19. The Japan Foundation, Japan.
- Horwitz, E. K., Horwitz, M. B., & Cope, J. (1986). Foreign Language Classroom Anxiety. *The Modern Language Journal*, Vol. 70, No. 2, pp. 125-132. Wiley-Blackwell, United States.
- Kobari, N. (2014). Penelitian Dasar Terhadap Motivasi Mahasiswa yang Memilih Keahlian Pendidikan Bahasa Jepang. *Jurnal Bahasa dan Sastra*, Vol. 14, No. 2, pp. 117-130. Indonesia Education University, Indonesia.
- MacIntyre, P.D., & Gardner, R.C. (1994). The Subtle Effects of Language Anxiety on Cognitive Processing in the Second Language. *Language Learning*, Vol. 44, No. 2, pp. 283-305. Wiley-Blackwell, United States.
- Noels, K.A. (2001). Learning Spanish as a Second Language: Learners' Orientations and Perception of Their Teachers' Communication Styles. *Language Learning*, Vol. 51, No. 1, pp. 107-144. Wiley-Blackwell, United States.

- Noels, K.A., Clément, R., & Pelletier, L.G. (1999). Perceptions of Teachers' Communicative Style and Students' Intrinsic and Extrinsic Motivation. *The Modern Language Journal*, Vol. 83, No. 1, pp. 23-34. Wiley-Blackwell, United States.
- Noels, K.A., Pelletier, L.G., Clément, R., & Vallerand, R.J. (2003). Why are You Learning a Second Language? Motivational Orientations and Self-Determination Theory. *Language Learning*, Vol. 53, No. 1, pp. 33-63. Wiley-Blackwell, United States.
- Norton, B. (2013). *Identity and Language Learning: Extending the Conversation*, 2nd edition, Multilingual Matters, Bristol, United Kingdom.
- Norton Peirce, B. (1995). Social Identity, Investment, and Language Learning. *TESOL Quarterly*, Vol. 29, No. 1, pp. 9-31. Wiley-Blackwell, United States.
- Norton, B. & Toohey, K. (2011). Identity, Language Learning, and Social Change. *Cambridge Journals of Language Teaching*, Vol. 44, No. 4, pp. 412-446. Cambridge University Press, United Kingdom.
- Pelletier, L.G., & Vallerand, R.J. (1996). Supervisors' belief and subordinates' intrinsic motivation: A behavioral confirmation analysis. *Journal of Personality and Social Psychology*, Vol. 71, No. 2, pp. 331-340. American Psychological Association, United States.
- Rodríguez, M., & Abreu, O. (2003). The Stability of General Foreign Language Classroom Anxiety across English and French. *The Modern Language Journal*, Vol. 87, No.3, pp. 365-374. Wiley-Blackwell, United States.
- Sila, A.Y. (2010). Young Adolescent Students' Foreign Language Anxiety in Relation to Language Skills at Different Levels. *The Journal of International Social Research*, Vol. 3, No. 11, pp. 83-91. Ordu University, Turkey.
- TDB (2014). Tokubetsu Kikaku: Dai 2 kai Indonesia Shinshutsu Jittai Chousa [Special Program: The Second Field Survey of Business Expansion to Indonesia]. Teikoku Data Bank, Tokyo, Japan. <http://www.tdb.co.jp/report/watching/press/pdf/p140605.pdf>. Last Accessed 15 June 2015.
- The Japan Foundation (2008). *Kaigai no Nihongo Kyouiku no Genjou: Nihongo Kyouiku Kikan Chousa 2006 Nen Kaichouban* [The Current Situation of Japanese Language Education Overseas: Japanese Educational Institutions Survey Year 2006 Revised Edition], Bonjinsha, Tokyo, Japan.
- The Japan Foundation (2011). *Kaigai no Nihongo Kyouiku no Genjou: Nihongo Kyouiku Kikan Chousa 2009 Nen* [The Current Situation of Japanese Language Education Overseas: Japanese Educational Institutions Survey Year 2009], Bonjinsha, Tokyo, Japan.
- The Japan Foundation (2013). *Kaigai no Nihongo Kyouiku no Genjou: 2012 Nendo Nihongo Kyouiku Kikan Chousa yori* [The Current Situation of Japanese Language Education Overseas: From the Fiscal Year 2012 Japanese Educational Institutions Survey], Kurosio Publisher, Tokyo, Japan.
- Wenger, E. (1998). *Communities of Practice: Learning, Meaning, and Identity*, Cambridge University Press, Cambridge, United Kingdom.
- Wertsch, J. V. (1998). *Mind as Action*, Oxford University Press, New York, United States.
- Williams, K. E., & Andrade, M. R. (2008). Foreign Language Learning Anxiety in Japanese EFL University Classes: Causes, Coping, and Locus of Control. *Electronic Journal of Foreign Language Teaching*, Vol. 5, No. 2, pp. 181-191. National University of Singapore, Singapore.
- Yanling, Z., & Guizhen, J. (2006). Anxiety in Foreign Language Classroom. *China English Language Education Association Journal*, Vol. 29, No. 6, pp. 96-103. China English Language Education Association, China.
- Young, D.J. (1991). Creating a Low-Anxiety Classroom Environment: What does Language Anxiety Research Suggest? *The Modern Language Journal*, Vol. 75, No. 4, pp. 426-439. Wiley-Blackwell, United States.

**Topic :** Sosial Science and Sustainability

**The Support of Public Works And Community Housing  
Development Ministry On Poverty Eradication Through Special  
Fisherman Home**

Hakim, S.Pd, M.Pd<sup>a</sup> and Arin Fithriana, S.IP, M.Si<sup>b</sup>

*a.Lecturer of Architecture Technique Faculty, Budi Luhur University, Budi Luhur University, Highway Ciledug, North Petukangan, South Jakarta 12260, Indonesia*

*b.Lecturer of International Relations, Social and Politics Faculty, Budi Luhur University, Budi Luhur University, Highway Ciledug, North Petukangan, South Jakarta 12260, Indonesia*

---

**Abstract**

This study describes the support of Public Works and Housing Development Ministry on people in meeting the housing needs for the fishing community through the development of special homes in all parts of Indonesia based on the filing of local government. This particular home using conventional building typologies / walls and wooden stilt home. This study uses a qualitative methodology with descriptive analytical research by collecting primary and secondary data that refers to the form of structured interviews and field observations supported by literature relating to the theme. This study uses a series of theories and concepts such as the State, SDGs, Poverty and Special Home concept for fishermen. The results of this study show that the support of the Public Works and Public Housing Ministry as government institutions in alleviating poverty as a form of implementation on fulfilling the needs in the field of housing and settlement for fishing communities was corresponded to the attainment of SDGs program.

**Keywords: Poverty, State, Custom Home, Sustainable Development Goals (SDGs)**

---

**1. Background**

Indonesia is the largest archipelago in the world that consists of 17,508 islands with a coastline of 81,000 km and Sea area of 3.1 million km<sup>2</sup>. According to UN Convention in 1982, Indonesia has the potential of biological resources and non

---

<sup>a</sup> Budi Luhur University, Highway Ciledug, North Petukangan, South Jakarta, Telephone : +6221 5853753; Fax : +6221 7371164, [hakim\\_hr@yahoo.com](mailto:hakim_hr@yahoo.com)

<sup>b</sup> Budi Luhur University, Highway Ciledug, North Petukangan, South Jakarta, Telephone : +6221 5853753; Fax : +6221 7371164, [arin\\_030302@yahoo.com.au](mailto:arin_030302@yahoo.com.au)

biological abundance. This causes most people to stay and occupy the area around the coastal areas as well as dependent as fishermen. As a nation state that has a vast sea area and fertile land, it should Indonesia become a prosperous nation. Becomes unnatural when the wealth of such a large turn out to be prosperous. Indonesian territory that is wide enough to be part of the power and wealth of Indonesia as a nation-state. On the other hand the power and wealth could be turned into a potential threat to the survival of the nation state. . With a coastline and vast ocean that is so, ideally coastal communities have the welfare of higher than inland communities, given the natural resources and biodiversity of Indonesia is abundant in the region of the sea. But in fact, especially in coastal communities directly border to another state or frontier area, the real condition is different. Some fisherman in coastal border area life in lack condition, both social and economic life. This condition can worsen the national integration and sovereignty of the country. Fishermen society is a society living in coastal regions with their main livelihood is to utilize the natural resources found in the ocean in the form of fish, shrimp, seaweed, coral reefs and other marine resources. Life in the oceans to form their characteristics into characteristics that are very hard and full of risks, especially the risk that comes from natural factors.

Fishermen have a very substantial role in promoting human life. They included an agent of development is the most reactive to environmental changes. It is more open than the group of people living in the interior into a stimulator to accept the development of modern civilizations. In such context arises a positive stereotype about identity, especially fishermen and coastal communities in general. They are considered more educated, insights on life is much broader, more resistant to the trials of life and tolerant of differences. Revenue fishing communities directly or indirectly, will greatly affect their quality of life. Revenue from the sea is a major source of income, or even the only way for them. The size of the revenue will greatly affect their lives, especially in their ability to manage the environment in which they live.

In general, there are two (2) categories of fishermen in Indonesia are traditional fishermen and modern fishermen. Traditional fishermen are fishing the workings assisted by using inadequate equipment or are still using manual tools such as using a canoe with paddle means by human power or catch fish with nets. While modern fishing is fishing the workings uses sophisticated equipment such as by boat or catch fish using a tool such as trawl.

In the daily life of traditional fishermen oriented to meet its own needs, in terms of the allocation of the catch is sold more widely used for everyday basic needs, especially food and not reinvested for expansion of business scale. Fishing conditions mentioned above are compounded by increasingly limited and the high price of land for housing and settlement, narrowing access to the fishing communities to obtain housing and livable neighborhoods. The reality conditions above shows that the low level of social welfare in coastal areas, as shown on the distribution of disadvantaged areas that dominate the area and the archipelago. One reason is the lack of investment value (including facilities and infrastructures) supporting marine and fisheries sector.

The existence of settlements of fishermen are intimately associated with the source of fishing, the area of distribution of the catch and the beach area, where the beach should be easily reached by public with transport and good road network, enriched with a variety of social activities, economic and cultural dazzling without damaging the environmental compatibility to develop settlements in the coastal areas are built or improved facilities and infrastructure fishing settlement. Development of infrastructure is expected to be the center of formation and development of fishing communities, the center of economic activity and where the processing and marketing of fishery products integrated. It would be multiplayer effect of development.

If the fishing community is only able to meet their basic needs then other needs such as improved management of settlements as well as facilities and infrastructure would be abandoned, this will lead to environmental degradation of their settlements as

housing conditions that have been damaged cannot be repaired, the local roads damaged nor serious attention, be completed due to financial constraints of the fishing communities who live in the neighborhood, so the development environment of fishermen has decreased (stagnation conditions of the settlement) as the stagnation of the development of a residential neighborhood and fulfillment facilities and infrastructures existing support can even have an impact on the emergence of seedy neighborhood (slump area) and will affect the development of global settlement conditions for growth and development of the region is the physical manifestation of economic activity. Problems in drainage and sanitation networks are also not treated immediately, and many more problems that they are not exist in the neighborhoods.

## 2. Issues

Based on the background and the above problems, there is support from the Ministry of Public Works and Housing of the people meet the need for a place to stay that's habitable for Fishermen community. The home care program under the auspices of the Director General Provision of Housing, the Directorate of Special Housing with a special home delivery work for fishermen.

This government program is part of a national action plan on achieving the Millennium Development Goals (MDGs) which continues on Sustainable Development Goals (SDGs) with a target of achieving by 2030. This action plan form implementation of global agreements that occurred on 25-27 September 2015 in a meeting grand headquarters of the UN (United Nations), New York, United States. This meeting is a continuation of the agreement document MDGs. When the 193 UN member states unanimously adopted a document entitled "Transforming Our World: The 2030 Agenda for Sustainable Development". SDGs have a foundation that is five aspects; People, Planet, Prosperity, Peace, and Partnerships who want to achieve three lofty goals in 2030 in the form of ending poverty, achieving equality and tackling climate change. Based on the seventeenth of development goals, this study focused on the target of poverty alleviation through development by the Directorate of Custom Home, Custom Home Supply Directorate of the Ministry of Housing PUPR.

For more mapped the problems it will be explained using the following analysis models



Figure 1. Groove formation Custom Home Assistance Program

Based on these ideas, the discussion of the study include Indonesian fisherman poverty in Indonesia's border area, achievement of Sustainable Development Goals and national development and the implementation of special housing assistance program.

## 3. Indonesian Fisherman Poverty in Indonesia's Border Area

According to J. G. Starke Border is one of the most important manifestations of territorial sovereignty. As far as the border was explicitly recognized by the treaty or generally recognized without the assertion, then the border is part of a state's right to the territory. Borders are often interpreted as an imaginary line on the Earth's surface that separates the territory of one country to another. This border is in the form of land

border and maritime border. Land border is the locus of points or lines separating the mainland and parts thereof into two or more regions of different power, while the border waters of which the territorial waters or territorial waters.

Poverty is a condition of economic inability to meet the standard of living of average people in an area. The inability of these is characterized by low ability of income to meet basic needs in the form of food, clothing, and housing. The ability of low income will also have an impact reducing the ability to meet the standards of the average life such as public health standards and educational standards. Conditions of the poor people can be known by poverty that lack ability to meet the standards of living.

Definition of poverty which is currently used as a study popular development is poverty that is often found in developing countries and the third world countries. The issue of poverty in these countries is not just a form of incapacity earnings, but has spread in the form of its social and political powerlessness. Poverty was also considered a form of construction problems that caused their negative impact on economic growth is not balanced so that widening income gap between the community and the income gap between regions (inter region income gap). Development studies today are not only focused its study on the factors that cause poverty, but also identify all aspects that can make the poor.

Indonesian border region poverty is evident by the lack of infrastructure which is owned by the region. Lack of good transportation, communication, health care, education, the economy and everything that related to human needs including energy and water. Therefore, the Indonesian border area is part of the development of the national spatial plan. Based on Government Regulation 26 of 2008 on Spatial Planning, the border region of Indonesia are in the development of Indonesian Archipelagic Sea Lanes (AKLI) and the Exclusive Economic Zone (EEZ). As government regulation, in the figure bellow shows the location of the border of Indonesia, which became part of the development of the national territory. 10 boarders location in 26 cities as centre of national strategic activation (figure 2)

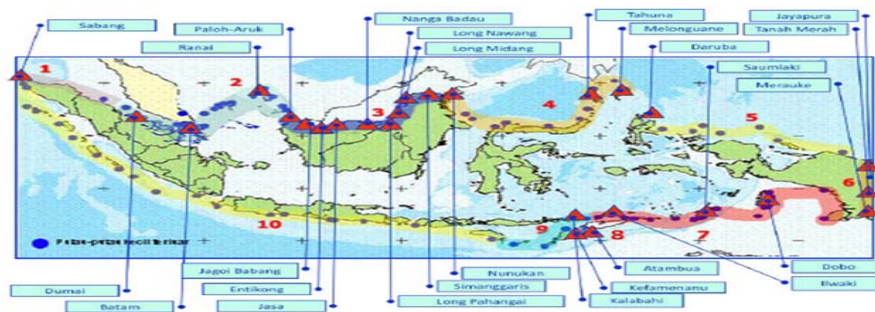

Sumber: Peraturan Pemerintah No. 26 Tahun 2008

Figure 4.1. Location Border region of Indonesia.

Figure 2. Location Border region of Indonesia.

As the image area locations Indonesian border, seen, that the border area is largely underlined the coast of Indonesia. So in generally, which cultural, social and economic communities living on the border in accordance with the conditions of their environment. In general the people in the coastal border area are fishermen. Fishermen border in Indonesia synonymous with simplicity and even poverty. This is evident from the exchange rate of Indonesian fishermen compared to other agricultural sectors the exchange rate is still quite small even in 2007 was only 9.62 percent of the total value of agricultural exchange. Very small compared to the area of marine waters of Indonesia. This condition is directly proportional to the fishing conditions. This means that if the exchange rate of small fishermen, then so does the income of fishermen is also small. This revenue will impact on their welfare. On the other hand the border region is remote



area far enough from the center of government, so some border areas experiencing gaps in development. Not just the fishermen, but also impacts on the environment where the fishermen live, including infrastructure, education, health and other social services.

Some border areas are located on the coast with the lives of fishermen that still require attention welfare, among others are ; District Sebatik East Kalimantan, District Tahuna, Sangihe, North Sulawesi, District Atambua, Belu, East Nusa Tenggara, Kampung Skouw Sae, Muara Tami District , Kota Jayapura

#### 4. Achievement of Sustainable Development Goals (SDGs) and National Development

Since the reign of Joko Widodo, the national development agenda developed through "Nawa Cita" which consists of nine development priorities. Nawa Cita developed in the National Medium Term Development Agenda (RPJMN) 2015-2019. On the other hand, there is a global agreement related to the Sustainable Development Goals (SDGs) for the period 2016-2030. To follow the global agreement, the Indonesian government needs to translate and integrate into the national development agenda and regional development.

There are four main focus areas of UNDP and the government of Indonesia as a form of convergence Nawa Cita and SDGs, that gap, Environment and Energy, Governance (anti-corruption) and Global partnership. In connection with the research focus of poverty reduction through the development of Custom Homes by the Directorate of Special Home Supply, Directorate of the Ministry of Housing - PUPR, the convergence seen in Nawa Cita 3 and 5. In Nawa Cita 3 emphasizes on the development of suburbs. In this case the outskirts covers the border area which is the area most edge of the national territory of Indonesia. Construction of the suburban part of efforts to maintain the unity of Indonesia. suburban areas, especially in border area as potentially experiencing disintegration, especially if there are social and economic inequality are quite high and uneven development. While in Nawa Cita 5, one form of a prosperous Indonesia Program is to ease the people to get a home to stay.

Table 1. Convergence Nawa Cita, RPJMN and SDGs:

Nawa Cita	RPJMN	SDGs
N.3. Indonesia build from the periphery to strengthen these areas and villages within the framework of a unitary state	Section 6.3. Indonesia build from the periphery to strengthen these areas and villages within the framework of a unitary state. - Laying the foundation of basic commencement of asymmetric decentralization - Distributing development among regions, especially in eastern Indonesia - Tackling poverty	G1. Ending poverty in all places in all forms
N.5. Improving the quality of human life by increasing the quality of education and training with Indonesia Pintar program, as well as the improvement of social welfare programs and prosperous Indonesia Indonesia Work by encouraging land reform and land ownership program, program sequence village houses or flats cost sera subsidized social security for the people	Chapter 6.5. Improving the quality of human life and the people of Indonesia; - Building on population and family planning - Developing education: implementing Indonesia Pintar program - Build health: implementing the program Healthy Indonesia - Improving the welfare of marginalized people: Indonesia implement the program of work - Improving the welfare of the community through sustainable livelihood.	G1. Ending poverty all over the place in all its forms

Based on the suitability or convergence between the Nawa Cita, Medium Term Development Plan and the destination SDGs, it needs real implementation of the policy. Ending poverty would not be an easy and smooth. Inter-sectoral collaboration and awareness is necessary that poverty eradication as a common goal and not an individual goal. One way to alleviate poverty is to meet the basic needs of society. The housing needs is one of the basic necessities of human life, thus fulfilling the needs of the housing is one solution. The government through the Ministry of Public Works and Housing, Directorate General for the Provision of Housing strives to meet the basic needs. Some policies have been made by the ministry. In the administration of President Joko Widodo special housing program implemented by the Directorate of Special Home Supply Directorate General of Housing. Ministry PUPR, allocated Rp 1.4 trillion to build 6,002 housing units specialized in the whole of Indonesia. The house specialty is built will be for members of the TNI / Polri, people in rural areas, disadvantaged areas, fishermen and people living in border areas. In addition to the border area house special Ministry PUPR program includes also a special need for resettlement housing, resettlement of disaster victims, social homes to accommodate elderly, the poor, orphans and abandoned children. Including for the construction of houses and homes, which are located scattered in the border region. This may be as a single house, duplex or row house typology in the form of sole houses or stilts. Existing home today many are not habitable and the quality is poor compared to homes in neighboring countries. For the people in the border area and the periphery, one manifestation binder confirms the presence of the government is a decent home for them .

## **5. Fishermen's Custom Home Assistance Program**

As mandated in Article 28-h 1945, the home is a basic human right in addition to clothing and food, as well as a reflection of human identity, either individually or in a unity and togetherness with the natural environment. Housing also has a strategic role in the formation of character and personality of the nation, so it needs to continue to be fostered and developed for the sake of continuity, improvement of life, and livelihood.

The state is responsible to protect all the Indonesian people through the development of housing and residential areas so that people can live and occupy decent housing and affordable housing in a healthy, safe, harmonious, and sustainable in all regions of Indonesia. Growth and development of the region are paying less attention to the balance of the interests of low-income people, that lead difficult-low income people to obtain decent and affordable homes

Notching the physical settlement of fishermen community in general based by the process of growth and development of a settlement. The process of growth and development of a residential community of fishermen historically most of the settlements that grew naturally, spontaneously grow and develop sporadically. As a result, in most settlements fishing communities in Indonesia looks less well ordered, tend to be irregular (sporadic) and tends to develop spontaneously or naturally. Because of the location and the location is far from the cities, settlements conditions of fishing communities still have not been touched by their regional planning activities.

The house specialty is the house that was organized to meet the specific needs among other things for the community house in the border area, the people affected by government development programs, people living in the outer islands, remote, disaster-affected communities, prone to the risk of social, cultural heritage area, homesteader, older people, the poor, orphans and / or abandoned children, people in the area of processing of natural resources.

Shape physically from settlement patterns fishermen usually in the form of: (a) pattern elongated (linear) along the shoreline, (b) the pattern of a group or cluster to the

center of settlement activity, usually around the mouth of the river, (c) patterns of parallel, namely the settlements already tend to be large or wide, (d) patterns of loops and / or curve linear especially on settlements by contour relatively steep, and (e) patterns of a compound or a combination of the patterns on the settlement of fishermen who have large or widespread. This discussion related to the physical environment of settlements fishing communities, in addition to the condition of the settlement, also discussed the completeness / provision of facilities and infrastructure for housing, housing conditions or houses where he lived and environmental sanitation conditions around the settlements.

Residence or adequate housing is one of the standard of living or standard of welfare of people in an area. Under these circumstances, a society called poor if it has a much lower income than the average income, so that not many have the opportunity to prosper himself.

Indonesia's Government through Public Work and Community Housing Ministry conduct special housing program for fisherman border. Beneficiaries based on Permenpera No. 10 of 2015 on Guidelines Help Special House, including the people living in the outer islands and fishing communities. In practice, the construction of special houses of fishermen in need of support from various parties such as developers and investors. Support and involvement of the private sector is regulated in Article 6. Implementation Stages and implemented as set out in Article 9 to Article 45 in the Regulation of the Minister of Housing No. 14 / Permen / M / 2006 on the Implementation of Special Area Housing.

To apply for a special housing assistance, applicants must meet the following procedures:

- People apply for assistance to the Government of Regency / City.
- The Government of Regency / City forward proposals to the Provincial Government.
- Proposed assistance addressed to the Ministry of Public Housing.
- Proposal of Kodim / TNI Military Command coordinated by the Ministry of Defence.
- Proposal of the Police and coordinated by the National Police.
- Proposed entered in the database Ministry PUPR.
- Verify administration.
- Verify Field.
- Application of SK Recipient Custom Homes.
- Development auctions.
- Implementation of Development.
- The use and occupancy.
- Handover Assets.

The Implementation of the program for fishermen special house aid border is a program of the Ministry PUPR, but the implementation also requires the support and cooperation of various parties, both government and private sector and the public. Administrative Requirements Custom Homes development proposals include:

- *Location requirements*; such as Compliance with the Spatial Plan (RT/RW) Regency / City; Consideration of the bearing capacity of the soil and the environment; The location has access roads; There are sources of drinking water and electricity resources.
- *Requirements Soil conditions*; such as vacant land that free of buildings, permanent and free of plants that interfere with development; The topography or contour of the land that can be built housing is flat to gently sloping shape or slope steepness 0-15%; At Custom Homes will begin construction, the location of the land is not entail

the maturation process of land or land maturation has been done independently by the proposer Custom Homes.

For the implementation of the program, the Ministry of Public Housing define the implementation stages as the mechanism in the following figure:

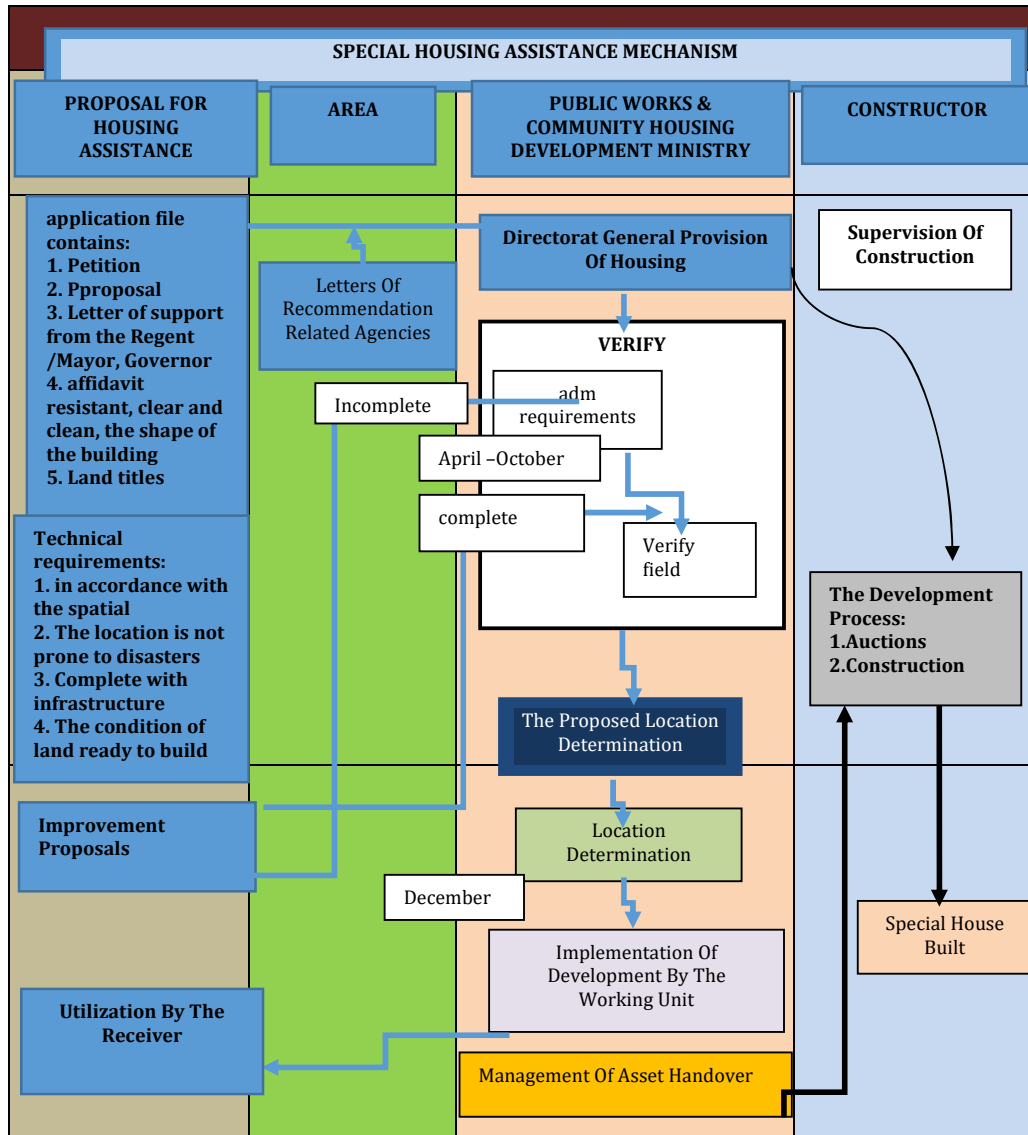

Figure 3. Special Housing Aid Mechanism

The mechanism include how the fisherman to propose to the spatial authority or the spatial authority to the government up to the final process, that are hand over asset. The price for a unit of special house average on 150 million IDR which the payment mechanism based on the asset regulation. The Special housing aid program for fishermen as part of the authority program to alleviating poverty and achieving the SDGs this certainly has a provision that was passed in the legislation. This serves as the foundation for the implementation of the achievement of national objectives and as a tool control policy that has been made by the government. Since the special housing assistance program was developed by the year 2014 from the development plan for the

fishermen as much as 2015 units of the border area, that has been only 912 inhabited. This condition occurs because there are some obstacles that also presents challenges such as limited state budget funds to built special house, the availability of land that is clear and clean in the area, and the limitation of resources the Ministry of Public Housing. One step to ease these obstacles could be handled by cooperate with private sector.

## 6. Conclusion

As the first achievement of the objectives of Sustainable Development Goals (SDGs) is the alleviation of poverty, then poverty reduction also include social protection for the poor. Taking the definition of social protection used by the UN in the "United Nations General Assembly on Social Protection", ie as a collection of government policies and programs as well as the private sector created in order to deal with the various things that cause a loss or substantially reduced income/ salary received; provide assistance to the family (and children) as well as providing health care and housing. In more detail explained that social protection provides access to the effort to fulfill basic needs and basic human rights, including access to income, life, work, health and education, nutrition and shelter. Additionally, social protection is also intended as a way to reduce poverty and absolute vulnerability faced by people are very poor.

Social protection for the poor have the handling is different in each country. this is because every region has different characteristics. This difference is also the basis for the implementation of the housing program specifically fisherman border. As explained above that the construction of the house specialty is also adjusted to the readiness of the region, georgraphy conditions and social and cultural life of society, a condition that became a challenge for the implementation of the program. Special home construction fisherman border is part of social protection for the community. Through the construction of the house specialty, basic human needs are met. Fulfillment of basic needs will encourage people to improve subsequent fulfillment. In this case, it is assumed that the home be the cornerstone of the next social activity, including the adjustment of home form

Based on this insight, the special assistance program of fishermen house especially, the poor fisherman who is on the border Indonesia is part of the fight against poverty as the first destination SDGs. This objective directly to sustainable national development. If the national development can be achieved and implemented properly, it will directly impact on national integration which is the main purpose of the Indonesian government.

## 7. References

- Bengen. D.G, (2001).Sinopsis. Ekosistem dan Sumberdaya Alam Pesisir dan Laut. PKSPL-IPB. Bogor
- Budiharjo, Eko (Ed.), 1997, Arsitektur Pembangunan dan Konservasi, Penerbit Djambatan, Jakarta
- Blaang, C. Djemabut.(1986). Perumahan dan Pemukiman.Gadjah Mada University Press, Yogyakarta.
- Cresswell, John W.,(2010) Research Design: Pendekatan Kualitatif, Kuantitatif dan Mixed, Pustaka Pelajar, Jakarta
- Judohusodo, Siswono, (1991) Tumbuh nya Pemukim Pemukim Liar di Kawasan Perkotaan, JIIS.
- Anup Shah, Poverty Around The World, <http://www.globalissues.org/article/4/poverty-around-the-world>. Last Accessed 11, November 2011
- Caterina Rugeri Laderchi, Et. Al. *Does It Matter That We Do Not Agree On The Definition of Poverty? A Comparison of Four Approaches*, Oxford, 2010.pdf <http://www3.qeh.ox.ac.uk/pdf/qehwp/qehwps107.pdf> . Last Accessed 19 Maret 2014

According to issuing agency's regulation, Permenpera No 10 Tahun 2013 tentang Pedoman Bantuan Rumah Khusus

According to issuing agency's regulation. Peraturan Menteri Negara Perumahan Rakyat Nomor 15 Tahun 2006 Tentang Petunjuk Pelaksanaan Penyelenggaraan Pengembangan Kawasan Nelayan

Background study, RPJM Kelautan Perikanan 2015-2019, Analisis Pencapaian Nilai Tukar Nelayan (NTN), Kerjasama Kementerian Perencanaan Pembangunan Nasional (BAPENAS) dengan Japan International Cooperation Agency (JICA), Januari 2014

Laporan Akhir Penyusunan Prototipe Rumah Khusus di Perbatasan Negara DRKN 15-06, Kementerian PU-PR, Direktorat Rumah Khusus 2016

**Topic :** Public Studies

## **The Translation of Japanese Manga in German and English**

Moe Otsuka\*

*Graduate School of Humanities and Social Science, Chiba University, Yayoi-cho Inage-ku,  
Chiba-shi, 263-8522, Japan*

---

### **Abstract**

In this study, I investigate problems in the translation of manga and solutions to these problems. The translation of manga has peculiarities when compared with that of literary works. The text in manga is to be read with illustrations and is mostly conversational in style. This study aims to research German and English translations of manga, which have different translation policies. First, I treat the differences in cultural habits, the biggest issue in the translation. I research the elements that are difficult for foreign readers to understand, and solutions the translators developed to tackle these difficulties. Second, I investigate the word exchange in the conversational context that occupies the majority of the text in manga. I study the function of texts in the conversational sequence and the maintenance of that function in the translation. In conclusion, I found that, first, the translators exchange verbatim translated words with the proper native expressions, or add accounts according to background knowledge about Japanese culture that readers are presupposed to have. Second, they change the original elements on purpose in some cases in order to maintain the conversational sequence. The translators do not only assimilate the Japanese elements to their own culture, but also reserve Japanese vocabulary or cultural characteristics in order to maintain balance. My investigations have revealed that as a whole, manga translators successfully introduce modern Japanese culture through manga.

(Abstract should be approximately 200-250 words in length)

### **Keywords**

translation studies; Manga; German; English  
(Include approximately 5 keywords)

---

### **1. Introduction**

Japanese manga has enjoyed a substantial international market and has come to be seen as new symbol of Japan. This new status was made clear by the closing ceremony of the 2016 Summer Olympics in Rio de Janeiro, Brazil. Japanese in anime and manga characters presented Tokyo, Japan as the site of the next summer Olympic Games.

---

\* Corresponding author. Tel.: +81-080-5694-9109; fax: +81-047-451-0526.  
*E-mail address:* moe.otsuka.29@gmail.com

Because of their popularity overseas, dozens of Japanese mangas are translated and published every month. Demand for the translated texts of Japanese manga is on the rise from foreign manga readers, but research into these translated texts is not common. Therefore, methods for analyzing manga texts have not been fully developed.

In this study, I discuss problems in the translation of manga and their solutions. The main object of inquiry is the translation of manga texts. For the purpose, I define manga texts and how the translations are analyzed.

Manga translations have peculiarities when compared to literary works. This study aims to research translations of manga into German and English, which have different attitudes towards translations. I refer to an increasing popularity of manga in Germany. For this study, I use Japanese manga, "Yotsubato!" as the translated text.

## 2. Methods

I divide my analyzing methods into six parts.

First, the popularity of manga in Germany has been increasing, resulting in a sale boom. Two manga series caused this boom: "Dragon Ball" and "Sailor Moon." Both series targeted children as their main audience. Since their introduction, Japanese manga has increased its share in the German market. GfK Entertainment reports that the sales of manga grew almost 15 percent from the previous year in 2015. Jüngst (2007) reports that because of the acceptance of manga in Germany, German manga-readers understand Japanese manga features; for example, they can change reading direction, use easy Japanese vocabulary, and so on.

Second, how are manga texts defined? Manga pages have two types of content: literal texts and text illustrations. The former means that the character's speech is mostly contained in a speech bubble. The latter comprises onomatopoeia or depicted characters in the background. In this study, I discuss the former and define these texts as "literal texts." Unser-Schutz (2010) investigates the ratio of manga texts and reports that the majority of text in manga is speaking text.

Third, how are manga texts used in Japanese language education for foreign students? Texts of manga and anime are used for teaching Japanese. The study of Japanese language education says that the features of manga and anime texts are much the same, meaning that manga texts are speaking texts. Therefore, I suggest that manga texts can be analyzed as speaking texts.

Fourth, how do we analyze speaking texts? Austin (1955) defines a speaking text as one performing a "locutionary act." He further breaks a locutionary act down into an "illocutionary act" and "perlocutionary act, perlocution." The former means uttering a "question," or "statement," for instance, by performing a locutionary act. The latter affects the acts and emotions of the others reachable through the locutionary act and illocutionary act. Furthermore, the ethnomethodology uses a real speaking text as a target for their investigation of conversational organization. I utilize this methodology for my study.

Fifth, how are translation studies conducted? The functionalist approaches define translation as the act of communication. Vermeer articulates the purpose of translation as "skopos," "purpose" in English derived from Greek. According to skopos, the translation can be evaluated. Fujinami (2001) decides a parameter for evaluating translation within the functionalist approaches. Fujinami analyzes whether the translation, along with its purpose, is achieved. This attempt means that translated texts can be evaluated using a visual parameter. Pursuant to this method, I use a parameter for the purpose of analyzing translated texts.

Finally, I introduce "Yotsubato!" (literally meaning "Yotsuba with !," "Yotsuba" is the name of the heroine, who is a five-years-old girl, and "to" is a grammatical conjunction in Japanese meaning 'and') by Azuma Kiyohiko. The heroine, "Yotsuba" is a five-year-old girl experiencing ordinary Japanese everyday life, which is recorded in the manga.



Because the heroine is a child and also a foreigner, “literal texts” include word plays or mistakes; and because ordinary Japanese everyday life is written in the manga, “literal texts” include many aspect of Japanese culture. These elements present a common problem of translation. Moreover, the “literal texts” of “Yotsubato!” are mostly speaking texts. Because of these factors, I chose “Yotsubato!” as the subject of my study.

I divide “literal texts” into two types and analyze them: unfamiliar concepts for non-Japanese manga readers and conversational texts.

### 3. Unfamiliar concepts for foreigner non-Japanese manga readers

To study unfamiliar concepts for non-Japanese manga readers, I picked out notes from texts of manga, because it has been observed that there are aspects of manga that non-Japanese readers might not understand. In keeping with the notes methodology, I use a classification system that takes into account the function of note, originally proposed by Nida (1972) and a classification of the translating intercultural concepts by Franco (1996).

- A classification system taking into account the function of note by Nida (1972)
  - (1) A correction of difference between languages or cultures
    - (a) A habit, (b) Geographic or material concepts, (c) An equivalent of weight or capacity, (d) Word play, (e) Supplementary explanation on a proper noun, etc.
  - (2) A supplement of background information for understanding the relevant text
- A classification of the translating intercultural concepts by Franco (1996)
  - i) Repetition
  - ii) Orthographic adaptation
  - iii) Linguistic (non-cultural) translation
  - iv) Extratextual gloss
  - v) Intratextual gloss
  - vi) Synonymy
  - vii) Limited universalization
  - viii) Absolute universalization
  - ix) Naturalization
  - x) Deletion
  - xi) Autonomous creation

Consider the following example:

Example 1

	(1j) Vol.12, p.167	(1d) Bd.12, S.167	(1e) Vol.12, p.167
Dad	やんだはご飯炊け もし失敗したらお前だけハヤシライスだ Yanda ha gohan Take. Moshi shippai shitara omae dake hayashi rice da. (Yanda, cook rice. If you fail, I serve a hayashi rice only for you.)	Du kochst den Reis auf, Yanda. Lass es anbrennen und du kriegst nichts außer Wasser. (You cook rice, Yanda. It making burn, you get nothing but water.)	Steam the rice, Yanda. If you screw up, you eat <u>hayashi rice</u>
note	/		Hayashi rice is a thick beef stew served over rice. It's almost the same thing as curry, but with different seasonings.
way	/		ii) Orthographic adaptation+ iv) Extratextual gloss+ (2) A supplement of the background for understanding the relevant part

In an example 1, Yotsuba goes camping with her father, her father’s friends, and her own friends. The time for dinner comes, and the campers start to prepare dinner: curry rice. Yotsuba’s father orders Yanda, his friend, to cook the rice (example 1).

The word, “hayashi rice” is annotated in English. The note for hayashi rice consists of a first half, an explanation of the food, and the second half, an explanation of a similarity between curry with rice and hayashi rice. The second half indicates that serving hayashi rice to Yanda is a punishment for Yanda’s failure to cook properly. Therefore, this

note functions as a (2) A supplement of background information for understanding the relevant cultural aspects of the translation.

On the other hand, in German, the word for hayashi rice is deleted and the phrase “nothing but water” is used as a substitute. This alteration in German means that German readers cannot understand the similarity between curry with rice and hayashi rice because of their unfamiliarity with hayashi rice. Moreover, in the German version, notes are used to solve this problem. Finally the expression of viii) Absolute universalization, “nothing but water” is used to convey it as a suitable punishment for Yanda’s offense.

Translation of unfamiliar concepts is used in different ways in German and in English. In German, notes are hardly used and the problems of translation are solved with alterations of literal texts. When a note is used in a German version, it consists of at most an explanation of the word. In English, however, notes are used frequently. In addition, a note often contains supplementary background information for understanding the relevant concept in addition to an explanation of the word. It is obvious that the resources provided in each version are considered the best translation for each set of readers.

#### 4. Conversational texts

To analyze conversational texts I chose the expression, “Nan da sore? / Nani sore? (What does it mean? / What is it?)” because I think that this expression can mean various things and play different parts in the conversation. However, I do not analyze English versions because this phrase is translated without alteration in English versions.

I developed a parameter for analyzing the phrase, “Nan da sore? / Nani sore? (What does it mean? / What is it?)” consisting of four points below:

- A parameter for analyzing the phrase, “Nan da sore?”
  - I) Illocutionary act
  - II) Evaluative expression
  - III) Attitude
  - IV) First pair part

The first content piece is I) Illocutionary act, the concept discussed above in the discussion about Austin. The phrase, “Nan da sore? / Nani sore? (What does it mean? / What is it?)” acts mainly as a “question,” also secondarily as a “statement” when the speaker talks to him- or herself. This occurs in the Japanese and German versions.

The second is II) Evaluative expression. This is demonstrated with a positive or negative sign (“+” or “-”) and only occurs in the German version. Because in Japanese the phrase denotes a “question,” it is neither positive nor negative and consequently is only ever marked with the symbol “±.”

The third is III) Attitude. Attitude can be positive or negative attitude and is denoted with “+” or “-” in the Japanese and German versions. In addition to analyzing the literal text and visual content in illustrations, we also analyze a silence in the text, an exclamation point, the shape of a speech bubble, the shape or a size of letters, and character expression. This content is analyzed as II) Evaluative expressions and evaluated as sarcasm when results differ from one other.

The fourth is IV) First pair part. If the phrase is intended to ask a question, an answer is strongly expected. This sequential organization is called an “adjacency pairs,” the first part is a “first pair part,” and the second is a “second pair part.” However, if the first pair part indicates a question to oneself, second pair part is not expected. Questions can be marked to show what type of content they are: a first pair part, a “question” or a “talking to oneself,” with “o” or “x” in the Japanese and German versions.

Consider the following sample:

Example 2

	(2)Vol. 9, pp.100-101	(3d)Bd9, S.100-101
Yanda	どこ行くの？ 叙々苑？ Doko iku no? Jojo-en? (Where is we going? Jojo-en?)	Wo geht's denn hin? Jojoen? (Then where we go? Jojoen?)
Jumbo	ジュージュー うちの近所の 今日半額だってよ Ju-ju. Uchi no kinjo no. Kyou hangaku date yo (Ju-ju, in the neighborhood of my house. Today they said it is having a discount service to half.)	Nein, ins Juujuu. Die veranstalten heute eine Spachtelorgie zum halben Preis. (No, to Juujuu. It has organizeds a banquet at half-price today.)
Yanda	うそ！ 倍食えるじゃん Usu! Bai kueru jan. (Really? We can eat twice as usual.)	Dann kann ich ja doppelt zuschlagen! (Then I can really eat twice!)
Dad	よつばー 焼き肉行くぞー Yotsubaa. Yakiniku iku zoo. (Yotsuba. We go for Yakiniku.)	Yotsuba. Komm. Wir gehen. (Yotsuba. Come. We are going.)
Yotsuba Dad	にーくだー Niiku daaa. (Meat!)	Lecker _ _ Fleisch. (Delicious ... meat ...)
Yotsuba Dad	にーくだー Niiku daaa. (Meat!)	Lecker _ _ Fleisch. (Delicious ... meat ...)
Yotsuba Dad	やーき//ハにーく//だー Yaaki // niiku // daaa. (Grilled // meat // Yeah!)	Lecker _ // _ lecker _ // _Fleisch! (Delicious ...//...Delicious...//...meat ! )
Yanda	え!? 何それ!? E!? Nani sore!? (Eh? What does it mean!?)	Wow! Ist das ein neues Spiel?! (Wow! Is it a new game?!)
Yanda	よつば それ俺ともやろうぜ Yotsuba. Sore ore tomo yarou ze. (Yotsuba, play it with me, too.)	Ich will mitspielen, Yotsuba. (I want to play together, Yotsuba.)
Yotsuba	いや やらん Iya. Yaran. (No, I don't.)	Nein. (No.)

Table 1 for example 2

	I) Illocutionary act	II) Evaluative expression	III) Attitude	IV) First pair part
J	question		—	×
D	question	+	+	×

In example 2 Yotsuba and her father play their original game using hands and singing. Yanda sees it and asks, “Nani sore!? (What does it mean?)”.

The I) Illocutionary act is a “question” in both versions. The II) Evaluative expression in German is the positive because of positive exclamations “wow” and “neu (new).” However, the image of Yanda is angry, with white inverted triangular eyes, upwardly alanting eyebrows, and a large opened mouth. Therefore, in Japanese, III) Attitude is negative, but in the German version, this content is positive because of positive exclamation. In the German version, this content comes into disagreement with the expression. The phrase indicates that Yanda is talking to himself, and the IV) First pair part results is “×” in both versions. Because Yanda does not talk with Yotsuba and her father immediately after he speaks, “Yotsuba. Sore ore tomo yarou ze (Yotsuba, play it with me, too.)” shows that their answers are unnecessary.

As a result, the phrase is changed from the Japanese version, and in ③Attitude The German and Japanese versions differ. In this alteration, the impression of the phrase is also changed. In the Japanese version, Yanda’s “Nani sore!? (What does it mean?)” can be interpreted negatively, even though he interprets the game positively in the following

lines, “Yotsuba. Sore ore tomo yarou ze (Yotsuba, play it with me, too.)” However, this impression is deleted in the German version.

It is obvious that in the alteration for the translation, the interpretation of conversation sequence can be changed. On the other hand, the evaluative expression and attitude remain mostly unchanged and the expression for these can be changed during translation.

## 5. Conclusion

In this study, I propose method of analysis for translated manga texts and demonstrate analysis with it. Because I have shown that manga texts are speaking texts, I suggested method of analysis based on the analysis of real speaking texts and using similar parameters. I divided “literal texts” of manga into two types and analyzed them: unfamiliar cultural concepts to non-Japanese manga readers and conversational texts.

In conclusion, I found that, far from a word-for-word translation of concepts or conversational sequences of the different culture, translators exchange the words translated verbatim with the proper native expressions, or add details according to assumed background knowledge about Japanese culture on the part of readers; second, translators change the original elements on purpose in some cases in order to maintain the conversational sequence. It is obvious that the translators do not only assimilate to their own culture, they also exclude Japanese vocabulary or cultural concepts in order to balance their translations.

Manga Texts have many different contextual features. How the translator translates these texts can be decided by determining which factor is important, what is demanded by the manga reader, or who reads manga in general. By these elements, translators decide how they will translate words and concepts.

## References

- Austin, J. (1955) *How to Do Things with Words*, Oxford University Press, Oxford, United Kingdom.
- Azuma, K. (2007-2013) *Yotsuba&!*, Wehner, Marcus(Trasl.), 1-12Bde, TOKYOPOP, Hamburg, Germany.
- Azuma, K. (2009-2016). *Yotsuba&!*, Amy, Horsyth(Vol.1, 4-9), Marcus Wehner(Vol. 2-3, 10-13) (Trasl.), Vol.1-13, Yen press, New York, USA.
- Azuma, K. (2003-2015). *Yotsubato! (Yotsuba&!)*, ASCII Media Works, Tokyo, Japan.
- Franco, J. A. (1996). Culture-specific Items in Translation, in Álvarez C.-Á. Vidal(Eds.) *Translation, Power, Subversion. Multilingual Matters*. pp.52-78, Bristol, United Kingdom.
- Fujinami, F. (2001). *Kotoba Asobi Honnyaku no Kinou Shugiteki Kousatsu (Das Übersetzen des Wortspiels unter funktionalem Gesichtspunkt)*, Doitsu Bungaku Ronshu (Beiträge zur Germanistik), Vol.30, pp.61-84, Kobe, Japan. [in Japanese]
- GfK Entertainment. (2015). 50 PROZENT MEHR UMSATZ: DAS GESCHÄFT MIT MANGAS BOOMT, Baden-Baden, Germany. <http://www.gfk-entertainment.com/news/50-prozent-mehr-umsatz-das-geschaeft-mit-mangas-boomt/2826-50-prozent-mehr-umsatz-das-geschaeft-mit-mangas-boomt.html>. Last Accessed 9 August 2016.
- Jüngst, H. (2007). Manga in Germany – From Translation to Simulacrum. *Perspectives: Studies in Translatology*, Vol.14, No.4, pp.238-259, DOI:10.1080/09076760708669042
- Nida, E. (1972). *Honnyakugaku Josetsu (Toward a science of translating)*, Naruse, Takeshi (Trasl.), Kaibunsha, Tokyo, Japan. [in Japanese]
- Unser-Schutz, G. (2010). *Ninki Manga no Corpus de Miru Moji Hyogen no Bunrui ni Tuite (‘From the Corpus of Popular Mangas the Classification of Literal Representation’)*: Nihon Manga Gakkai Dai 10 Kai Taikai Program / Happyou Youshishu (The 10th Annual Meeting of the Japan Society for Studies in Cartoon and Comics), Yokohama, Japan. [in Japanese]

**Topic :** Social Sciences and Sustainabilities

## **The Development of Organic Farming and Family Change in Postwar Japan**

Chiyo Yonemura\*

*Faculty of Letters, Chiba University, 1-33, Yayoicho, Inage-ku, Chiba-shi, 263-8522, JAPAN*

---

### **Abstract**

This research analyzes the development of the organic farming movement in Postwar Japan from the perspective of family change. Many organic farmers and their communities that emerged during the 1970s were opposed to the dominant agricultural methods which promoted heavy use of agricultural chemicals. Strong ties between farmers and consumers were one of the most significant characteristics of those communities, some of which still exist, while others are confronting management difficulties.

First, this research will briefly overview the characteristics of these communities and their social backgrounds in the 1970s, particularly their family histories. Similarities among these groups were as follows: 1) Producers and consumers were strongly involved in environmental and agricultural policies. 2) Consumers supported farmers not only by purchasing organic products, but also by helping the farm. 3) Urban housewives who had migrated from rural areas composed the majority of consumers demanding safe produce.

Second, we would like to consider these communities in terms of family change. Most Japanese farmers, organic or otherwise, are family farmers, so many are confronting succession problems. In addition, consumer families are undergoing changes. For example, core members are aging and the younger generations have different approaches to obtaining reliable produce, such as visiting specialty stores or farmers market.

In summary, this paper will suggest reinvestigating the social value of non-commercialized organic farming in contemporary society.

### **Keywords**

*Organic farming; Family Change; Family History; Postwar Japan*

---

\* Chiyo Yonemura. Tel.: +81-43-290-2289; fax: +81-43-290-2289.  
*E-mail address:* yonemura@chiba-u.jp

## 1. Introduction

This research analyzes the organic farming movements, which have emerged and developed since 1970s in postwar Japan especially in Chiba prefecture, from the perspective of family sociology. While it is common for researchers to focus on the policy or ideology when they study about such movements, this paper will also pay attention to how these movements managed their farming by their family members. Because their sustainability have been closely related to the interrelationships between farmers and consumers, it is important for the study to focus on the management of family farmers on the one hand, and the lifestyle of the consumer family on the other hand.

Considering family histories, this paper will address a frontier family in Narita as a case study (Sanrizuka no Tochi ni Ikiru wo Kankosuru Kai, 2000), and also farmers in other Chiba areas (Nakano and Nakajima, 1982; 1983; 1985) (Nakano et.al., 1984), in order to investigate their motives and consciousness towards these movements.

As a conclusion, we would like to intend the social value of the concepts of organic farming movement today, even though many groups experienced the decreasing of number of their members.

## 2. Material and Methods

Document data written, by the members of community themselves, will be used for this study (Kitahara, 1996) (Sanrizuka no Tochi ni Ikiru wo Kankosuru Kai, 2000) (Koizumi, 2004). It includes data edited and written by the director of farmers' school in Chiba (Takeuchi, 1988; 1994) (Wada, 1991) (Fukutake Tadashi Sensei TsuitoBunshu Kankokai, 1990) (Chibaken Noson Seinen Yoseijo, 1973) (Noson Chuken Seinen Yoseijo, 1963). Especially the village daughters' transcripts for their mothers were one of the core resources for analysis (Wada and Takeuchi, 1973).

## 3. Characteristics of organic farming communities and their backgrounds

### 3.1. Policies

#### 3.1.1 Example of "Teikei" principle

Japan Organic Agriculture Association (AOAA) was founded in 1971 and is one of the oldest and the largest associations of organic farming in Japan and has the ten principles of "Teikei". "Teikei" and "Sanchoku" are keywords of the organic farming movement in Japan. "Teikei" refers to the producer-consumer co-partnership in the organic farming movement and "Sanchoku" refers directly delivering agricultural produce from the farm to consumers. These concepts have provided the model for other groups, and represented the approach of the Japanese organic farming community. The 10 principles of "Teikei" are as follows:

#### THE TEN PRINCIPLES OF "TEIKEI" (A SUMMARY)

- To build a friendly and creative relationship, not as mere trading partners.
- To produce according to pre-arranged plans on agreed upon by both the producer(s) and the consumer(s).
- To accept all the produce delivered from the producer(s).
- To set prices in the spirit of mutual benefits.
- To deepen mutual communication to achieve mutual respect and trust.

To manage self-distribution, either by the producer(s) or by the consumer(s).  
To be democratic in the group activities.  
To be interested in studying issues related to organic agriculture.  
To keep the members of each group at an appropriate number.  
To continuously make progress, even if it is slow, towards the final goal of the successful management of organic agriculture and an ecologically sound life.

<http://www.joaa.net/mokuhyou/teikei.html>

<http://www.joaa.net/english/teikei.htm>

Quoted from English site, but with modifications.

### *3.1.2. Agricultural policies and industrial development*

After the end of WW2, Japanese society was confronted with a serious food shortage. The government aimed to increase food production and to promote the increase of land owning farmers. The modernization of agriculture and rural villages were the key concerns both for the government and villagers. The mechanization of agriculture and the use of pesticides were vigorously pushed forward in order to streamline agriculture. In the 1970s, however, the government changed their policy and began to promote reducing rice acreage, a policy known in Japanese as “gentan-seisaku”, because of the overproduction of rice.

In the industrial areas, an increase in production was also put forward after WW2 in order to reconstruct the Japanese economy. Right after WW2, both agricultural and industrial reformation were strongly promoted, however, as a result, it caused serious pollution problems such as in ‘Minamata’, and farmers were confronted with the paradox of their farming (Minamata disease is one of the four major pollution-caused illness in Japan).

Under such circumstances, some farmers started organic farming in order to sustain their livelihood.

### *3.2. The Characteristics of Organic Farming in Chiba*

To consider the characteristics of the organic farming movement in the Chiba area, we would like to address two points: the struggle with the construction of Narita airport and the geographical proximity to the metropolis. The anti-construction movement against Narita airport was one of the most serious political movements in postwar Japan (Uzawa, 1992). Additionally ‘the Sanrizuka One Pack Yasai’, which was organized among the anti-construction group members was one of the most famous organic farming groups at that time. Narita was the symbolic focal point of the contradiction between prioritizing economic development and improving agriculture in postwar Japan.

#### *3.2.1. Geographical proximity to Tokyo*

Because Chiba prefecture is located near Tokyo, it has been supplying various resources such as labor, industrial products and agricultural produce to Tokyo. It is noted that white-collar families, blue-collar families and farmers all co-existed in Chiba.

##### *a) Chiba as an urban suburb*

If one were to get on the train at a station in Chiba early on a weekday morning, one would see trains to Tokyo desperately crowded with commuters. In the 1970s numerous apartment complexes called “Danchi” were built in Chiba. Many families living

there were white-collar families who moved to cities from country areas. Today some of them are confronted with population decline and aging as in other suburbs in Japan.

b) Chiba as an industrial area

Chiba has also distributed industrial products since 1970s. We can find many factories in the bay area. Some of them have already withdrawn from Chiba because of the economic decline of Japanese heavy industries, and now those areas are planned as a redevelopment area.

c) Chiba as an agricultural region

Regarding the agricultural population, the number of farmers who do farming both as their main job and side job are higher in Chiba than in many other areas of Japan. On one hand there are old villages which have existed since prewar time, on the other hand, many farmers have moved to Chiba and cultivated their land after WW2 (Fukuda,2001).

d) Characteristics of Chiba

As we have seen above, Chiba experienced not only the prosperity but also the decline of the rapid economic growth in postwar Japan. In addition, the contradiction between agricultural policies and industrial development were easily observed. Due to such a historical and geographical background, Chiba became one of the locus of the organic agricultural movement.

### 3.2.2. Political Movement against the Construction of Narita Airport and Organic Farming

“Sanrizuka One Pack Yasai” is an organic farming group started by 3 farms in1976. Since then, while it experienced the increase and decrease of both the farmers and consumers, it has been continuous until now (Funato, 2004). “Sanrizuka” is the name of a place in Narita city, and it is the symbolic place of the anti-construction movement against Narita airport.

## 4. Family History and Change

### 4.1. A History of a pioneer family in Narita

If one would like to consider why the anti-construction struggle against Narita airport was so serious, the history of pioneering in Narita after WW2 would have important meaning.

One should not understand the impact of the construction of Narita airport without regarding the family histories of the pioneers. As a case study, this paper will look at a family who settled in Narita and started farming after WW2. The Shimamura family settled in the Toho district of Narita City in 1946, right after the end of WW2 (Sanrizuka no Tochi ni Ikiru wo Kankosuru Kai, 2000). They had lost everything during the war and moved to Narita. At first the wife of Ryosuke Shimamura worked as a hawker peddling produce, and her husband worked as a casual laborer to survive. Then the government decided to dispose of prefecture-owned land to demobilized soldiers, and the Shimamura family applied for this plan and finally got their land. It took a long time to get their farm into gear. By the time they felt settled, the government had decided to construct the new Tokyo International airport in Narita in 1966. That’s why not only the Shimamura family, but also many other frontier families, organized the anti-construction movement against Narita airport



#### *4.2. Why they started organic farming*

In the case of “Sanrizuka One Pack Yasai”, farmers and their supporters were strongly and closely organized through their participation in the anti-construction political movement. Farmers started farming organically right when the struggle between anti-construction groups and police was intensifying. And the consumers who, agreeing on group policy, but not attending the demonstrations themselves, became the members of “Sanrizuka One Pack Yasai”. This was the most symbolic case of the organic farming movement in which the political movement and the organic farming movement were directly connected.

In other areas in Chiba, some organic farming groups emerged around same period. To explain such movements, this paper will indicate the historical and social background of a farmer’s school in Tateyama-city in Chiba which established in 1952, because some leaders of the “teikei” movements graduated from this school, and made networks with each other. Considering their self-consciousness as farmers, and how they regarded their experience at school, this paper will examine the source of their ideas and their way of thinking towards the organic farming movement and producer-consumer co-partnerships. There were similar schools in other areas in Japan, so some commonalities among them can be seen in their ideas regarding farming. However, this school was one of the famous schools in Japan at that time, and the first director of the school educated and influenced many leaders in the Chiba area.

They had to find a way to manage their farms sustainably in the face of society’s prioritization of economic growth. For this reason, some graduates of this school promoted organic farming, or “teikei” farming. It was an alternative not only to the modernized agricultural method and the agricultural policies of the government, but also to the custom of the ‘mura (village community)’ and ‘ie (family system)’ (Yonemura, 2013; 2014).

This research will focus especially on the daughters of farmers who went to this school. By investigating documents they wrote, the way they saw their mothers and former generations can be observed.

Daughters acknowledged their respect for their mothers on one hand, but they distinguished themselves from their mothers’ generation on the other hand. The key concepts were “farmers who think”, and “farmers who speak”. If one hear these phrases today, it may sound trite, however, in those days, it sounded considerably strong or strange, especially when women said such phrases. Because the farming was managed according to custom or the mandates of the government, it wasn’t easy for younger generations to change or reform such systems (Kano, 1983).

To learn the context and the position of the agriculture and the problems of the agricultural policies at that time, they became aware of the importance of self-determination and self-assertion in order to improve their own farming, whereas the economic development and the improvement of heavy industries had the priority of the state policies. The young generation aimed to modernize their communities and farming in their own way, in order to improve their farms in the face of social change in postwar Japan. The way they pursued alternative methods of farming differed not only from the custom, but also from state policy.

#### *4.3. Family change of producers and consumers*

In 1999, the Ministry of Agriculture, Forestry and Fisheries (MAFF) added organic plants and organic processed foods of plant origin to JAS Standards. JAS means “Japanese

Agricultural Standard” and the organic JAS system refers to the certification system which requires the labelling of the organic JAS marks to the products that have been inspected by the ministry. According to MAFF, they introduced this system amid growing concerns of consumers over food safety and health consciousness. Nowadays one can obtain organic products with organic JAS label in supermarkets easily. Organic food became common and commercialized and it became convenient for consumers. For farmers on the other hand, if they want to get the certification, they must take the inspection regularly. However, the cost to request for the inspection is not ideal for small farmers.

The young generation in the 1970s became older and some farms are confronted with succession problems. The consumers in the 1970s are getting older, too. Therefore it becomes difficult for both producers and consumers to maintain their “teikei” group in the same way as in the 1970s. Additionally, their produce are not suitable to get the certification of organic JAS because of the cost of inspection and the types of land. The young consumers who are interested in organic produce are more likely to get such products at shops or in the supermarket.

In the face of these changes, the first generation of organic farmers try to find the other distribution channels so as the farmers market, community café and organic restaurants. It is another way of “teikei”, because farmers and consumers can relatively keep closer relationships than selling their produce in a commercialized way. Some consumers want to confirm the reliability of food not from the institutionalized standardization, but from the “face-to face” relationships.

## Conclusion

This study examines the development of the organic farming movements in postwar Japan, and the social value of the organic farming movements from the 1970s to present. In summary, the close co-relationships between producers and consumers in the 1970s, which characterized the strong motivated movements, had diminished in today’s society. This is the outcome of the change of families and the standardization and commercialization of the organic produce. The organic JAS system expanded the market of organic produce, and organic food has been accepted broadly amongst various generations in present societies. However, ironically, the produce by the “teikei” groups are not necessarily available in the supermarkets. Small farmers could not afford to apply for the JAS system and they had to find their own route in addition to the “teikei” groups. The business needs to stay in low-profile, but these farmers become reliable on other consumers who are loyal to specific organic producers. For consumers nowadays, although purchasing organic food does not necessarily mean that they are active in participating in the “teikei” movement, the intention towards the non-commercialized co-relationships between organic producers and consumers are recognized even today.

## References

- Chibaken Noson Seinen Yoseijo.(ed.).(1973).20nen no ayumi (The 20-year History).Chibken Noson Seinen Yoseijo, Chiba, Japan.
- Fukuda,C.(2001). Sanrizuka and Soil, Heigensha, Tokyo, Japan.
- Fukutake Tadashi Sensei TsuitoBunshu Kankokai (ed.). (1990). Kaiso no FukutakeTadashi (Reminiscences of Tadashi Fukutake), Fukutake Tadashi Sensei Tsuito Bunhu Kankokai, Tokyo, Japan.
- Funato, S. (2004).Yuki Nogyo to Seisansha no Kansatsuryoku:Narita Sanrizuka’Junkan Nojo’ no jireikara. (Organic Agriculture and the Farmer’s Powers of Observation A Case Study of Jyunkan-Nohjyo (The Recycle-Based Farm) in Narita-Sanrizuka Area).

- Nenpo Shakaigaku Ronshu (The Annual Review of Sociology).17:132-143, Tokyo, Japan.
- Kano,M.(1983). Senzen "Ie" no Shiso(Concepts of the "Ie" in Prewar Periods) Sobunsha, Tokyo, Japan.
- Kitahara,K.(1996).Daichi no Ran Narita Toso Sanrizuka Hantaidomei Jimucho no 30nen(Rebellion from the Land, Struggles of Narita: 30 years of the Anti-construction Movement According to Its Director), Ochanomizu Shobo, Tokyo, Japan
- Koizumi, H. (2004). Mimizu Monogatari jyunkan-Nohjyo heno Michinori(The Story of an Earthworm: The Road to Circular Agriculture), Commons, Tokyo, Japan.
- Nakano,Y. and Nakajima,S.(1982).Yuki Nogyo Kenkyu 1(A Study of the Organic Farming Movement 1).Chiba Daigaku Kyoyobu Kenkyu HokokuA(Journal of the College of Arts and Sciences, Chiba University. A) A15:357-415, Chiba, Japan.
- Nakano,Y. and Nakajima,S.(1983).Yuki Nogyo Kenkyu 2(A Study of the Organic Farming Movement 2).Chiba Daigaku Kyoyobu Kenkyu HokokuA(Journal of the College of Arts and Sciences, Chiba University. A) A16ge:369-446, Chiba, Japan.
- Nakano,Y., Nakajima,S. and Ito,K.(1984).Yuki Nogyo Kenkyu 3(A Study of the Organic Farming Movement 3).Chiba Daigaku Kyoyobu Kenkyu HokokuA(Journal of the College of Arts and Sciences, Chiba University. A) A17ge:265-356, Chiba, Japan.
- Nakano,Y. and Nakajima,S.(1985).Yuki Nogyo Kenkyu 4(A Study of the Organic Farming Movement 4).Chiba Daigaku Kyoyobu Kenkyu HokokuA(Journal of the College of Arts and Sciences, Chiba University. A) A18ge:207-265, Chiba, Japan.
- Noson Chuken Seinen Yoseijo. (1963). 10 Shunen Kinen Shi: Yoseijyo Kyoiku no 10 nen(10 Years of the Training School: New Education for Farmers), Chibaken Noson Seinen Yoseijo 10 Shunen Kinen Jikko linkai, Chiba, Japan.
- Sanrizuka no Tochi ni Ikiru wo Kankosuru Kai (ed.)(2000). Sanrizuka no Tochi ni Ikiru: Toho Shimamura Ikka no Ayumi(Living on the Land of Sanrizuka: Memories of the Shimamura Family in the Toho District). Machi kara Sha,Tokyo,Japan.
- Takeuchi,Y.(ed.)(1988). Hibikiau No no Kyoiku (Resonance of Agricultural Education), Tomin Kyokai, Chiba, Japan.
- Takeuchi,Y.(ed.)(1994). Hibikiau No no Sanchoku (Resonance of the "Sanchoku"), Tomin Kyokai, Chiba, Japan.
- Uzawa, K. (1992). "Narita" towa Nanika (What is "Narita"?), Iwanami Shoten, Tokyo, Japan.
- Wada,K.(1971). Noson Seinen Kyoiku no Jissen: Kanosei no Kaitaku (Practices of Youth Education in Farming Villages: Cultivating the Possibilities), Nosangyoson Bunka Kyokai, Tokyo, Japan.
- Wada, K. and Takeuchi, Y. (eds.) (1973) Musumetachi no tsuzutta Noson no Haha no Rekishi(Histories of Village Mothers as written by Their Daughters), Taimatsu sha, Tokyo, Japan.
- Yonemura,C.(2013). Chiba niokeru Sengo Nouminkyoku to Nogyo Shiso: Noson Chuken Seinen Yoseijo no Kyoiu Jissen nimiru(Farmers' Education and Thought in Postwar Chiba: From the Practices of Youth Education in Rural Villages).Ogata,T.(ed.)Chiba no Sozosei:Metropolis karano Gaibusei to Sozosei,132-142 ,Chiba, Japan.
- Yonemura,C.(2014)."Ie" wo Yomu (Readings of "Ie" Studies), Kobundo, Tokyo, Japan.

Websites:

- [http://www.maff.go.jp/e/jas/specific/pdf/organic\\_products\\_system\\_1501.pdf](http://www.maff.go.jp/e/jas/specific/pdf/organic_products_system_1501.pdf). (Last accessed 28 Oct. 2016 )
- <http://www.joaa.net/mokuhyou/teikei.html> (Last accessed 25 Oct 2016)
- <http://www.joaa.net/english/teikei.htm> (Last accessed 25 Oct 2016)

**Topic :** Social Sciences and Sustainabilities

**What do daughters think when considering their parents' thinking? : Interview analysis of unmarried women in the Tokyo area**

Akiko Fuchu \*

*Chiba University, 1-33 Yayoi-chou Inage-ku Chiba-shi, Chiba, 263-8522, Japan*

---

**Abstract**

This conference presentation discusses the relationship between parents and their grown-up daughters: how the parents' thinking and behavior influence those of their daughters who wish to get married.

In Japan, people, even as adults, are inclined to seek their parents' agreement when it comes to marriage. This paper focuses on how the consciousness and/or behavior of the parents work for their daughters in the process of encounter, dating, and marriage; how influential the parents' wishes are on their daughters' decision on whether to get married.

The research method used is the interview with seven unmarried Japanese women between the ages of 25 and 34 living in Tokyo. They were asked about their love experience and their view of marriage. The author particularly focused on their remarks about the relationship between themselves and their parents.

In the interview, these women often implied that their family was their role model. They said that they would like to emulate their parents' way of working (independent business, part time job, regular employment, etc.), and to have economic environment, and have a similar number of children as them. In terms of emotions, however, they related how their parents' love and marriage experiences were negative examples for them. They wanted to avoid the marital problems that their parents had faced including poor relationship between husband and wife or that between a wife and her parents-in-law. Thus, the result shows that the decision-making process of marriage for the daughters is influenced by the circumstances of their family.

**Keywords**

marriage; agreement with parents; influence from thinking of parents; Japanese women; unmarried women

---

---

\*E-mail address: [afda2859@chiba-u.jp](mailto:afda2859@chiba-u.jp)

## 1. Question

How does the thinking and behavior of parents influence that of their adult daughters who wish to get married? How do parents influence their daughters' views of marriage, design for the future, encounters, dating habits, and their experience of marriage?

## 2. Previous work

### 2.1. *David Notter introduced the concept of "negotiated marriage" (Notter, 2007).*

Pimentel used the term "negotiated marriage" to refer to one in which a parent has the right of veto (Pimentel, 2000). Notter introduced this concept as "kanshou kekkon" in Japan. Furthermore, considering the concept of "freedom" in choosing a partner, Notter argued that there was a problem regarding the "right to decide" on a partner (Notter, 2007:119).

Here, I describe the concept of rights between parents and children in Japan.

### 2.2. *A study on parent-child relationships by Yonemura*

Yonemura explained that the parent-child relationship is authoritative (Yonemura, 2010; 102). Yonemura's research indicates that parents hinder their children emotionally. However, the research shows that adult children express gratefulness towards their parents and consider their feelings. Accordingly, children design their future within their parents' allowable range, hopes, and desires.

This conclusion echoes Miyamoto's opinion. Miyamoto maintained that middle-class parents and children in Japan communicate through negotiation. This means that they do not directly express their wants to each other (Miyamoto, 2000). For Notter, this is likely akin to "negotiate," not "kanshou" (one way), and for Miyamoto, it represents "koushou" (interactive/two way).

### 2.3. *Logic of family sociology*

Looking back, sociology indicates the influence of parents on children when these children have values, for example in "Habitus" by Bourdieu (BOURDIEU, 1979) and "Body-ized Gender" by Yamada (Yamada, 1996).

Nowadays, in the field of qualitative research, negotiation is considered a popular approach in communication between family members about family behavior. This paper explores how adult children, specifically daughters, accept their parents' thinking and behavior, and how they associate their views of marriage or career with their parents' thinking and behavior. I analyzed interviews and considered the previous research.

## 3. Outline of the research

### 3.1. *The interviews*

I conducted semi-structured interviews with 10 unmarried women living or working in Tokyo from July to November 2014. The interview questions focused on their views of marriage and career design. In the interviews, I discussed participants' relationships with their parents. Therefore, I report on what six women said in the interviews. I conducted face-to-face interviews with each participant, each lasting between 60–90 minutes. In some cases, I recorded and transcribed the interview. In others, I took field notes.

Table 1. Objects of interview

Objects	age	boyfriends	living together	school background	job	professional history	a year's salary (million)
A	26	N	single	collage	regular employment children's nurse	children's nurse medical coding	3,0
B	30	Y	with parents/ single (before)	university	regular employment sales	none	4,0
C	30	N	with parents/ single (before)	university	regular employment managerial dietician at hospital	regular employment sales	4,0
D	30	Y	single	nurse school	regular employment nurse at hospital	regular employment/ a temp staffer nurse at hospital	5,0
E	30	Y	single	graduate school	regular employment career in research	regular employment career in research	4,5
F	26	Y	single	graduate school	student	none	0,5

### 3.1. Selection of interview subjects

The subjects of this research are unmarried women for whom getting married would be easy. In other words, there are no obstacles in their “encounters” and “dating experiences.”

In a previous study, unmarried people highlighted economic reasons or communication ability as factors that made encounters difficult. These factors apply to men, but no specific tendencies are evident for women. However, the increasing number of unmarried people or those that marry later in life are not confined to a specific age and hierarchy; thus, it is possible to lose sight of these reasons when hampered by economic or communication factors. The author focuses on women who face no obstacles in dating in terms of economic or communication issues to identify other factors applicable to Japanese women.

## 4. Analysis and Consideration

### 4.1. Categories

- 1) Awareness of marriage
- 2) Encounter, dating, taking the plunge, and getting married
- 3) Life after getting married
- 4) Designing a career

### 4.2. Explanation of Categories

About 1): Mothers teach their daughters about marriage. Daughters cannot help but be conscious about marriage. When marriage was not an issue of discussion, an informant noted, "There is no discussion on the usual, general things." Daughters

considered it normal that parents, specifically mothers, ensured they remained conscious of marriage.

[interviews]

A: My mom married when she was 26 years old, so she often asks me, "What about you?" Mom says most strongly.

B: Parents say "get married," but, everyone got married. Therefore, they ask me, "What about you?" However, in my family, my sister is experiencing so much trouble that they say it is okay if I do not get married.

C: (Interviewee noted that her mother asked her, "What about you?" when her friends got married.)

E: My two older brothers already got married and they already have children, so my parents do not expect me to marry. There is no discussion on the usual, general things such as because I will be 30 soon, I need to get married. This is not the case at all.

about 2): In some cases, mothers advise their daughters on the choice of a dating partner; for example, mothers assert that "That type of man is not a good man." In some cases, women accept their mother's advice, while in others, they do not.

[interviews]

A: My mother advises me on standards by which to choose a partner. For example, the second son is a good choice or something similar...or the man who rages is useless, so break up with him... or a partner who uses violence is useless on all counts....She is troublesome.

D: (About a year ago, interviewee D's boyfriend proposed.) However, my parents did not think he was a good choice, so we decided to put off our marriage.

F: My mom said that he was "not so good" (about her boyfriend). She indirectly said, "It is not good that a life is ruined by a man."

About 3): Women considered their mothers as role models. Regarding life after getting married, women used their mother's advice as a reference more than relying on their own will or thinking.

[interviews]

E: Mom has often worked in the past, and I always saw that. Therefore, this is why I think I like working too.

E-2: My family is self-employed, and I would ultimately like to be self-employed. Therefore, one of the terms of marriage will be to understand this type of thing.

F: I saw my parents...I am afraid that I will not be able to make money like they did. Really, I am very grateful, and thank my parents very much.

About 4): This is similar to 3). Daughters want to be accepted by their parents when deciding on their future, and they accept their parents' advice.

[interviews]

D: My brother and I did not want to spend our parents' money; therefore, I did not feel any pressure. I was not any trouble to my parents, because I saw my mom too. Both my parents worked. My mother is a very steady person, and she said to me, "There is nothing specific to become. Become a nurse. These days it is good that girls have a job." I heard this many times from my mother since being in junior high: "Nursing is a good job." It is like mind control, hearing your parents talking. That is what I honestly thought at the time.

F: I am overwhelmed that all the members of my family lovingly watched over me. Therefore, I should respond to them.

#### 4.3. Conclusions

The content of negotiation between middle-class parents and daughters was described. Miyamoto identified a few differences regarding negotiation in Japan; however, in this research, I found similar points to those found in previous studies.

Evident in this research is the characteristic that when adults talk about their parents, they express their gratefulness, not conflict.

More than negotiation, this is a balance between parents and daughters. It was found that daughters accept the will of their parents.

There is variety in terms of negotiated marriage, which is not variety regarding the right of veto. For this reason, I do not espouse Notter's work.

Miyamoto stated that there are certain characteristics of negotiation between parents and children in Japan. The reality of "koushou" is increasing, and this cannot be explained through Notter's previous work on "negotiated marriage." Similarly, Yonemura proved that there is both conflict and acceptance on the children's side, which is evident in communication between parents and children. Yonemura argues that parents will hold their children back. Parents' "intervention" is possibly adjusted only to the degree acceptable to children. I tend to agree, because parents seem to want their children to accept them.

The subjects of the interviews were women for whom there are currently no obstacles pertaining to finances, love, and communication. Therefore, the conclusion of this paper differs from studies focusing on people with difficulties in these matters. Previous work by Miyamoto indicated that different communication between parents and children depends on hierarchy; thus, this research did not focus on all Japanese women and their families. I consider focusing on different hierarchies as new knowledge, and would like to explore the concept further in the future.

## References

- Bourdieu, Pierre, (1979). *La distinction: critique sociale du jugement*, Éditions de Minuit, Paris, France.(=P. Bourdieu translated by Yoji Ishida, (1990), *Distinction I*, Tokyo: Fujiwara Shoten) .
- Miwa, Satoru. (2010). Unmarried person's sculptured group of the present-day Japan. In Sato Hiroki, Nagai Akiko& Miwa Satoshi(Eds.), *A Wall of Marriage*, p.13-36. Tokyo: Keiso-Shobo.
- Miyamoto, Michiko. (2000). Parents and Children of Declining Birthrate and Single Society: Change of Mean and Figure about 'Be an Adult'. In Hiroko Fujisaki (Ed.). *Parents and children—mixing their life course*, p.183-210. Kyoto: Minerva shobo. [in Japanese].
- Notter, David. (2007). Reconsideration about 'Romantic Love Ideology'. In *Pure Modern--Comparative Sociology of the Modern Family and an Intimacy*, p.111-131. Tokyo: Keiou-gijuku-daigaku Shuppankai. [in Japanese].
- Pimentel, Ellen E. (2000). Just Do I Love Thee?: Marital Relations in Urban China. *Journal of Marriage and the Family*, Vol.62, pp.32-47. USA.
- Tabuchi, Rokuro. (2012). Families and Intergenerational Relationships in an Era of Intergenerational Ambivalence: Approaches from a Family Strategy Perspective. *Japanese Journal of Family Sociology*. Vol.24, No.1, pp.37-49. Japan.
- Yamada, Masahiro. (1996). *Sociology of Marriage: Do single-ization and marriage postponement continue?* Tokyo: Maruzen Library. 47-64. [in Japanese].
- Yonemura, Chiyo. (2010). Parent Living and Independent Awareness: 'Goodness' and Conflict of a Parent-Child Relationship. In Iwakami Mami (Ed.). *Sociology of 'Youth and Parents'*, p.83-104. Tokyo: Seikyusha. [in Japanese]



**Topic :** Sosio-Humaniora

## **Japanese Soy Sauce Industry: a Legacy of the Centuries**

**Pradhikna Yunik Nurhayati\***

*Universitas Gadjah Mada, Yogyakarta, Indonesia*

---

### **Abstract**

Japan is a home for more than 53% oldest companies in the world. While more than 50.000 companies in Japan have more than 100 years history, longevity in the modern business world is increasingly rare. The average lifespan of corporation has been between 20 and 30 in 2010. The mortality risk for companies across all sectors is dramatically increased regardless of the age and size of the companies.

As the economic landscape of nations dominated by family business, most of the old companies in Japan are also managed by the family. Japanese family business runs the business for dozens of generation. There are several reasons to make it possible. First is adopting the business heir, if the biological heir unable to continue the business. Second is the tradition that has supported the business to continue. Most of Japanese companies founded before the year 1700 are culture oriented. Third is the culture of the company such as 'lifetime employment' that keeps the strong bond of personal trust for over the years.

In order to strengthen the analysis, this article is supported by the lesson learned from soy sauce industry specifically in Chiba Prefecture. Soy sauce is fundamental seasoning for Japanese cuisine. As the part of Japanese culinary culture, soy sauce industry has survived for hundreds years. Using strategic business management perspective, this article will examine how the soy sauce companies managed their business and survived as a family business for over the hundred years.

### **Keywords**

Family business; strategic business management; soy sauce; japan

---

\* Corresponding author. Tel.: +62-857-4360-5892; fax: +62-274-563362 ext. 222.  
*E-mail address:* pradhikna.yunik@ugm.ac.id

## 1. Introduction

In the modern business world, the longevity of the business is getting decline. According to Boston Consulting Group (BCG) Report in 2015, the life span of multinational company has been decreasing from around 50-60 in 1970 to 20-30 in 2010 (Reeves and Pueschel, 2015). As the matter of fact, “more than one-third of the corporations on the 1970 Fortune 500 list were no longer in existence by 1983” (Crockett, 2015). Companies are dying younger and more likely to collapse at any given time. BCG has reported “one-tenth of all public companies fail each year, a fourfold increase since 1965” (Reeves and Pueschel, 2015). The mortality risk is getting increasing for any scaled and aged of the company.

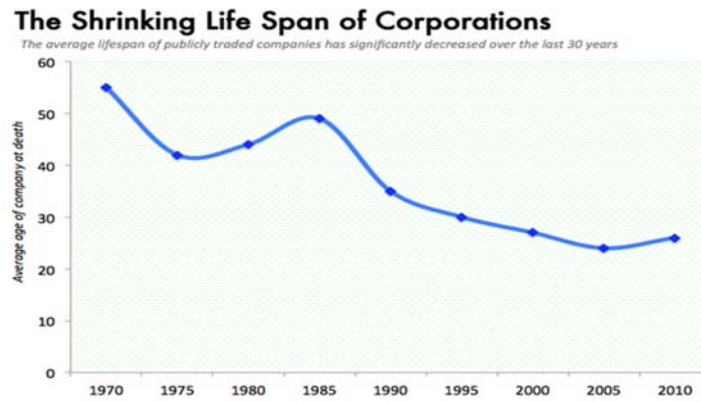

BCG Report, 2015

However, there are some exceptions for 967 businesses founded before 1700 that are still survived, become the oldest companies in the world. Astonishingly, 517 of them or 53% of the businesses are located in Japan (BCG as cited by Crockett, 2015). “Before being absorbed into a subsidiary in 2006”, the oldest family business in the world is Kongo Gumi (Tamkin, 2014). This construction company (built temple) was founded in 578. The list of the oldest companies in the world from Japan still goes on including Nisiyama Onsen Keiunkan (since 705), Tanaka Iga (religious goods company, since 885), and Sudo Honke (sake brewer, since 1141).

# The World's Oldest Businesses

*Japan contains the oldest business in a variety of trades and industries*

Type of Business	Name	Country	Year Founded
Oldest Hotel	Nishiyama Onsen Keiunkan	Japan	705
Oldest Machinery Company	TECH Kaihatsu	Japan	760
Oldest Restaurant	Stiftskeller St. Peter	Austria	803
Oldest Winery	Staffelter Hof	Germany	862
Oldest Religious Goods Company	Tanaka-Iga	Japan	885
Oldest Pub	Sean's Bar	Ireland	900
Oldest Confectionary	Ichimonjiya Wasuke	Japan	1000
Oldest Brewery	Weiherstephan	Germany	1040
Oldest Tea Company	Tsuen Tea	Japan	1160
Oldest Metalwork Company	Ito Tekko	Japan	1189
Oldest Sake Company	Sudo Honke	Japan	1141
Oldest Pharmacy	Sankogan	Japan	1319

(Cited from Crockett, 2015)

This article will mainly discuss about family business supported by lesson learned from soy sauce industry especially in Chiba Prefecture, Japan. There are several reasons that will be discussed that make Japanese family firms can survived for hundreds years. First is about the succession. Succession is become one of the substantial aspect to ensure the business sustainability. One of the main interesting finding from this research is how the family business in Japan commonly practicing adoption in order to looking for a business heir. Adoption is especially happened if the biological heir unable to continue the family business.

Second is the tradition that has supported the business to continue. Most of the Japanese companies founded before the year 1700 are culture oriented, as well as soy sauce. Soy sauce has become the important part of washoku, traditional dietary culture of Japan which emphasizes local ingredients and soy sauce as its unique seasoning. Still, the culture of the company such as 'lifetime employment' in Japan keeps the strong bond of personal trust for over the years.

In order to provide comprehensive overview of soy sauce industry, this article will also discuss about the management of the business. Using perspective of strategic business management, the last part of this article will examine the business from three aspect such as planning, implementation and evaluation.

## 2. Research Method

This article is written based on the research about soy sauce industry in Chiba Prefecture, Japan. There are nine companies/business involved as the interviewees. The scale of the business is vary from the small enterprises to the big companies. Companies

ages ranging from 91 to 328 years old. Using qualitative method, this research aims to provide information about management of the business especially about succession process. Data collection is obtained through the literature review, observation and interview with the director of the companies.

### **3. Discussion**

#### *3.1 Succession*

As the economic landscape of most nations are dominated by family firms, the study about family business is become important (Chrisman et al., 2003). However, there is controversy between academician related to definition of family business. As summarised by Chrisman et al., (2003), there are various definition to describe family business. Some of researches define it by the involvement of the family in the business (ownership, management, and trans-generational succession), while another authors emphasize on the influence of the family members in the business.

According to Dyer (1989), there are some weakness related to family business. First is the lack of skills. One of the main challenge for family business is the lack of management talent within the family. There are various skills needed to run the business such as marketing, finance, and accounting to make the business survived. As a family business grow especially in complex environment, the family members are likely unable to hold the key positions with all necessary skills needed. Therefore, there is a needed to bring professional management into the family business.

Another reason for professional management in family business is the norms and value of business operations. The value and the interest of family might affect the operation of the business because of the different goals between family and the business. When the business getting expand, there are many decision that will affect not only family members but also the staff of the business. The last but the most important reason for requiring professional management is to prepare the next leader for the family business. The founder of family business may want to retire and no one in the family consider as capable to continue the leadership.

As Dyer (1989) mentioned above, the succession is become substantial especially for the sustainability of the family business. For family business in Japan, there are several option to find the next successor. According to the interview, the next successor will be determined by some criteria. First is capability. It is important for the next successor to have ability to maintain and lead the business especially for the bigger business scale

that has complex requirement and involving many people outside the family members. Second is the interest. Once the candidate do not have any interest to continue the business, then she or he will be eliminated from the list. Hence, the selection of the next leader is not solely based on the family blood but also considering the interest and capability.

Mainly, the next successor will be selected by the current business leader. For the small business scaled, other family members will involved to decide the next leader of the business. The selection process mostly held by discussion amongs the family member or the board of director (for the bigger scaled business). Some of them will set a trial period for the candidate to measure the capability. Most of the candidate already familiar since they grown up with the business in their family.

Apart of capability, another concern is the interest of the candidate. Usually, the oldest son in the family will continue the business. Unfortunately, the fact might be different. The interest of the candidate might not be to continue the business. There are various finding related to the interest of the candidate. Some of company put "interest" as one of the criteria to be selected as the next business leader. According to the business leader, it is important to run the business based on the interest and willingness of the candidate. However there is some interesting case where the candidate has to choose between continue the family business or will be eliminated from the family. To continue the family business is tend to be mandatory for the oldest son in the family.

Related to the women successor, most of the business owner stated it is possible if the daughter is willing to continue the business as far as it is supported by her interest and capability. There is a case where the owner only has two daughters. One of his daughters has interest to run the business. Now the family support the daughter to be the next successor of the business. Another company stated that historically, their company also had women successor. It is depend on the quality and capability of the candidate.

Generally, the next successor will be selected during the young age. Some of the candidate needs to decide since they were teenager. As mentioned before, commonly the oldest son in the family will continue the business. On the other side, early age will give plenty of time to set trial period for the next successor and provide them training that necessary to continue the business. According to one of the interviewee, regeneration of the business leader in the young age also provides fresh idea from the business. The

young successor will be able to create innovation and implement fresh idea to develop the business.

There is none of the interviewees stated that they have non-family successor during their history. There will always be family member that able to become successor. In the case there is no son or daughter available to continue the business, they try to find another family members that have their eligibility as the next leader. In some extreme cases, if the business unable to find another candidate, the business will be shut down especially in the small scaled business. However, instead of recruiting professional manager, the family business in Japan tends to adopt their successor.

In the case where there is no biological children to continue the business, or if the owner of the business desire for better candidate as the successor, it is legal to adopt the successor. It is common for Japanese business owner to engage in this practice since a long time ago (Crockett, 2015). According to Crockett (2015), nowadays “98% of Japan’s 81,000 adoptees are males between the ages of 25 and 30 – many of whom are businessmen who are legally adopted by the owners of corporations and put in management positions”.

Business owner also can legally adopt son-in-law to continue the family business. This is also happened in one of soy sauce company that being interviewed. The current leader of the business is the son-in-law while the daughter plays the role as a manager of the restaurant and participated in developing new product of the company. Through the adoption as well as son-in-law, the practice of family business remains intact without risking the business into less capable son or nephew. Moreover, according to Mehrotra (as cited by Crockett, 2015), the performance of adopted successor is better compared to biological successor.

### *3.2 Tradition/Culture*

Other factor that supported the longevity of Japanese family business is the tradition. From 517 business founded before 1700, most of them are culture-oriented such as sake, paper lanterns, religious goods as well as soy sauce. There are the part of culture and daily life.

## What Are Japan's Oldest Businesses?

Of Japan's 517 businesses founded before the year 1700, these are the most common trades

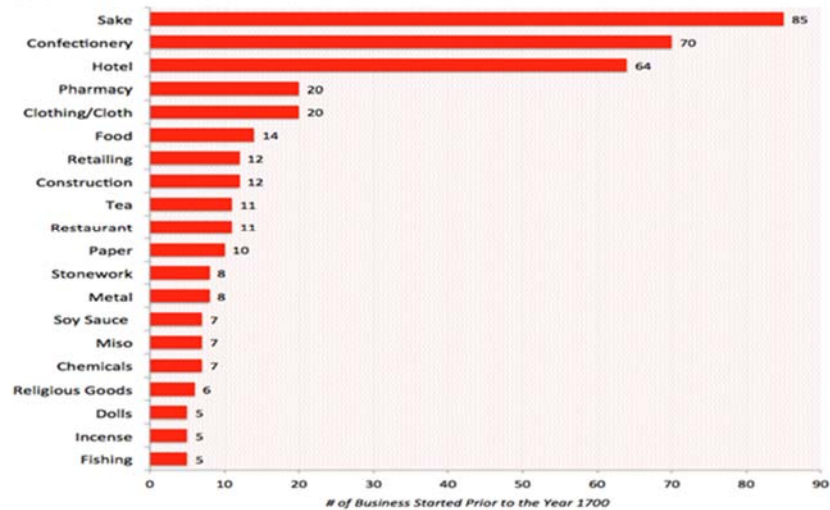

According to Nishikawa (2011), there are several reasons related to culture that make Japanese business can survived for hundreds years.

1. Character of the Japanese: integrity, tolerance, persistent effort and diligent is the part of Japanese characteristic.
2. Strong respect of the House (family name): the family name is considered as the most important asset to protect. It makes the principle of house-centric become ever lasting.
3. *Sanpo Yoshi*: value relationships to work together for harmony and mutual benefit between customers and business partners; local communities; owner of the company and the employees.
4. Flexibility and continuous improvement (*kaizen*): Tendency to continuously improve core products, services and technologies in a flexible manner responding to environmental changes.
5. Stable governance system: There is no foreign invasion in Japanese history, creating stable governance under the reign of the Emperor family.

In business framework, the heir adoption then becomes more rational because of the strong respect of the house. By adopting new successor, the family name still remains while avoiding the risk to handing the company to incapable successor. Put the goals of society rather than private goals also become one of the main characteristic of Japanese people. Therefore, integrity and persistence are the part of Japanese society.

The value of *sanpo yoshi* also manifests in the culture of company such as 'lifetime employment' that keeps the strong bond of personal trust for over the years. In one soy sauce company, there are some employees that work for more than one generation. There are some couple, or parent and children work in the same company. Other company will gladly accept employees after their maternity leave for two or three years. The relation between the owner and the employees is more like a family to support each other.

The manifestation of *kaizen* also can be seen in the product innovation. Every soy sauce company has their own innovation adjusting the need of customer such as halal product, free-allergic product, as well as the innovation of the packaging, marketing, and also the taste of products. For more comprehensive view of how the soy sauce business being run, the next part will discuss from the planning, implementation and evaluation process.

### *3.3 Business Management*

According to interviewees, the key of success for business are the persistence to survive in hard time; build and maintain the trust from the customer, partner and employees; and prioritise the goals of society than the private goals. However, there are still various goals of the business that want to be achieved. Among of them are expanding products to international market, producing various specific and excellent products, as well as expanding the business itself.

In order to achieve their future goals, every owner of the business always setting the goals and strategy every year. The target of the business is arranged based on the past performance and the future prospects. Some of them refers to other eminent company to learn and develop the business while other focusing on improving the capacity of human resources in the company. All of discretion belongs to the current business leader. They create new strategies to develop the business such as using the internet to promote the product especially international market; expansion of the retail sector; and managed to have a restaurant using their own products. Some of the business open to hired professionals to develop new products especially if it is related to specific products. Moreover, advice from different point of view will be useful to provide different insight and idea for the business.

The prominent aspect of family business compared to non-family business is the involvement of the family member. Family value might affect many aspects of the business. For small business scaled, influence of family members about management and



product development is more apparel. It is because for the small scaled business, family members are also involved directly in daily activities such as marketing or financial. Meanwhile, for other bigger business, business and family are two different things. The top management are still family members, but decision for the business will be made according to professional mechanism for the sake of many people.

Since soy sauce is highly related to culture and community, the business also put their consideration into contributing to society. Historically, Kikkoman as the biggest soy sauce company in Japan built hospital and bank to support their business. For smaller soy sauce business, the contribution may become vary depend on the ability of the company such as donation for local events and participating in social activities. In soy sauce industry, the waste of soy sauce making process is distributed to local farmers to feed the cattle for free.

The next step of business management is implementation stage. As mentioned above, for small scaled business, involvement of family members become prominent to support business activities. Meanwhile for biggest business where the need of employee is bigger, the influence of family member is getting decline. Only family members in top management that involved the business activities will influence decision making process.

In small soy sauce business, generally female family members are also involved in management of the business such as financial or product development. In fact, one of the company already decided their daughter as the next successor due to her capability and interest to continue family business. For bigger soy sauce business, female family members are not involved anymore. However, one of the business owner has mentioned that female employees have more contribution to the business. Female employees are considered as more persistent, thorough, and comprehensive for development of the products. Since most of soy sauce customers are women/wife, women perspective is become prominent.

Another specific issue that need to be considered in family business is the conflict between family members. Some of the business owner have admitted that conflict might be happen but the best way to deal with conflict is discussion. Through discussion among family members, the conflict is never caused damage or fatal effect for the business.

The last part of business management is evaluation process. This stage is become substantial especially when the goal of the business is not achieved during the year. The

business owner will evaluate the goals, strategy, and analyse the cause why the business goal are failed to achieve.

Discussion above indicates that even the business is owned by the family but the management of business is still considered as professional. Every family business always set their goals, strategy and mechanism to achieve the goal. They are also involving professionals if it is needed especially for developing new product. The next successor is also selected based on capability. There are various innovation to answer the challenge of business environment and adjust with the need of the customer. However it is substantial to consider the scale of the business. When the business is getting bigger, the percentage of family member involvement is getting decline. Thus, the professionalism is remains the same due to scale of the business.

#### **BIBLIOGRAPHY**

1. Crockett, Zachary. 2015. Why Are so many of the World's Oldest Businesses in Japan. Accessed at <https://priceconomics.com/why-are-so-many-of-the-worlds-oldest-businesses-in/>
2. Chrisman, J. J., Chu, J. H., and Sharma, Pramodita. 2003. Current Trends and Future Directions in Family Business Management Studies: Towards a Theory of the Family Firms. White Paper of Coleman Foundation and US Association of Small Business and Entrepreneurship.
3. Dyer, W. G. 1989. Integrating Professional Management into a Family Owned Business. Family Business Review 1989.
4. Ehara, Ayako. 2015. Continuation of Washoku Culture, and Traditional Local Dishes. Food Culture No. 25 - 2015. Japan: Kikkoman Institute for International Food Culture.
5. Nishikawa, Morio. 2011. Japanese Family Businesses: A View from A Family Business Advisor. Accessed at <https://cfb.bschool.cuhk.edu.hk/page/japanese-family-businesses-view-family-business-advisor>.
6. Reeves, Martin and Pueschel, Lissane. 2015. Die Another Day: What Leaders Can Do About the Shrinking Life Expectancy of Corporations. Accessed at <https://www.bcgperspectives.com/content/articles/strategic-planning-growth-die-another-day/>
7. Tamkin, Emily. 2014. Keeping It in the Family: Why are so many of the world's oldest companies in Japan. Accessed at [http://www.slate.com/articles/business/continuously\\_operating/2014/10/world\\_s\\_oldest\\_companies\\_why\\_are\\_so\\_many\\_of\\_them\\_in\\_japan.html](http://www.slate.com/articles/business/continuously_operating/2014/10/world_s_oldest_companies_why_are_so_many_of_them_in_japan.html)

Topic : S2

**Local Community Response To An Integration of Palm Oil Plantation  
With Research & Development And Manufacturing of  
Polyhydroxyalkanoates In South Sulawesi**

Fitriwati

*Fitriwati, Graduate School of Humanities and Social Sciences, 1-33, Yayoi-cho, Inage-ku,  
Chiba-Shi, Chiba, 263-8522. Japan.*

---

**Abstract**

This research analyzes the response of local community about a Polyhydroxyalkanoates (PHA) production in a rural area, and that integrates Research & Development (R&D) and manufacturing of PHA in one site of South Sulawesi. Descriptive data was obtained through discussions with local people in a community symposium and informal discussions following that in the Kamiri Village. The several discussions reveal that PHA is new for the local community and only the old generation people become very interested in R&D and manufacturing of PHA, for the reason of creating job opportunities for the young generation. The other discussions show that most of the young generation disregards a wage difference in different jobs offered by a firm because they do not pay attention to the full picture of the business and are just grateful that a plantation company comes to their area to open a new business. The results indicate that just an existence of a strong peer effect in a local community is not enough for R&D and manufacturing of PHA to be successful in the area.

**Keywords**

Palm Oil Plantation, Polyhydroxyalkanoates.

---

**I. Introduction**

This field research obtains the responses of local communities in the Kamiri Village of the Barru District concerning an idea to install a new business model that integrates a plantation of palm oil with Research & Development (R&D) and manufacturing of Polyhydroxyalkanoates (PHA) at a site in a rural area. The purpose of this research is to check the empirical validity of my hypothesis that a strong peer effect makes the idea viable. Descriptive data obtained by conducting a series of discussions in a community symposium and

informal interviews. The data reject the empirical validity of my hypothesis. Though there were plenty of evidence for the existence of a strong peer effect in local communities, those of age between 20 and 25 years, who are supposed to be the beneficiary of the business, did not show much interest in R&D for PHA. The result shows that a strong peer effect is not enough to install this business model. It suggests that how to create a peer effect is crucial for the purpose. This field study indicates that the mechanism to create a peer effect in the Kamiri village is a kind of coercion, which would work negatively for installing the business model in this area.

## **2. Description of Field Study**

This section describes the method of field study based on a community symposium. The goal is to clarify what done in the field study, in detail. The objective of the research is to test the acceptability of the idea to locals that they can employ to R&D activities. With that in mind, a series of discussions in a community symposium and informal interviews following it between a specialist on PHA and local people were conducted in the Kamiri Village. A symposium was held on December 20<sup>th</sup>, 2015, with the title "Introducing of manufacturing Polyhydroxyalkanoates (PHA) from palm oil industry to the local community". The participants were expected to be young and middle age farmers in the area, but 45 farmers including 25 elderlies and 20 younger generations in age between 20-25 years old attended the symposium, 5 for each farmers group (Gapoktan). The older farmers were interested in R&D and manufacturing of PHA, they were enthusiastic and would like to learn about PHA. But, other participants in the symposium did not speak out their interest. In this symposium, the older generations have the very important position for decision making from each farmer group. All farmers very enthusiastic to come to the symposium, they have intentionally left a job in the fields because this was the first time for them to know about PHA. PHA is plastic as material synthesized by many bacteria which is entirely biodegradable in nature. Therefore, PHA is an attractive material that could develop as biodegradable plastics (Sudesh Kumar, (2013)). PHAs are biodegradable plastics (Viviana Urtuvia et al., (2014)). The biodegradability of PHA makes it extremely suitable for substituting synthetic plastics (C.S.K. Reddy, et al., (2003))

There were attitude differences between the old generation and the young generation. The older generation interested in this business on the reason of creating job opportunities for the young generation. The young generation was interested in this business to increase their income. Responses in the community symposium show that the local community does not concern about the different wage levels of workers in various divisions of the firm because they are very grateful just for that a plantation company comes to open a new business in their area.

After the symposium, five locals in Kamiri Village were interviewed for informal discussions. These interviews were conducted during December 21<sup>th</sup>, 2015 to January 4<sup>th</sup>, 2016. These 5 locals are representative of five farmer groups (gapoktan), one of them is the young generation in age 25 years old with college graduated background and others are older farmers in age between 40-60 years

old. Those 5 farmers have expectation for job opportunity to increased their income. But only one older farmer of the participant in the interview understood the business. All participants are expected this business will be realized immediately.

In Kamiri Village, there is a Farmer Group Association called "Gapoktan" that consists of 9 farmers groups which all members in Gapoktan is farmers and the older. Gapoktan is a combination of several farmer groups who do agribusiness in increasing both production and income for its members with the aim of strengthening the farmer's institutions and boosting the economy in rural areas. The Kamiri Village consists of 8 hamlets with 9 farmer groups, each of which corresponds to a group except one because one of the hamlets has 2 farmer groups. All 9 Gapoktan in Kamiri village have the similarity as an economic institution in the rural areas-based agriculture, Gapoktan also as gateway institution in the rural area between farmer and the outside, namely in the marketing of agricultural products, the provision of agricultural production facilities, and including providing a variety of information needed by farmers.

This Kamiri Village located in the Barru District of South Sulawesi. The village located close to the Makassar City, which enables transportation to another island of Indonesia and abroad to be available. Furthermore, this village is along the railway line of Trans Sulawesi. The Kamiri Village located in Barru Regency; it is approximately 110 km from Makassar, the city of South Sulawesi. The Kamiri Village is close to the Port Garongkong, which has a depth of -15 m Lws and is the main gateway of export and import in the area of eastern Indonesia after Sukarno-Hatta Port of Makassar. This port located on the eastern side of the Makassar Strait, whose development is included in the Master Plan for Acceleration and Expansion of Indonesian Economy Development (MP3EI) 2011-2025. Through this port, people come from and go to East Kalimantan, South Kalimantan, and South Java every day. This port is use as a cargo port.

The Kamiri Village has an abundant of natural resources, a lot of lands that have not been cultivated or utilized effectively yet. Farmers had installed cloves plantations, but they did not produce clove fruits very well. Farmers are largely dependent on agriculture and plantations. Rice is the primary product of their agricultural activity. There are many crops plantation, which has been produced in the area, such as palm oil, coconut, chocolate, banana, hazelnut and others. But they still tend to use their agricultural products mostly for personal consumption. Some farmers turn coconut fruit into cooking oil and brown sugar in a traditional way, and then sell them in the traditional market. In the Kamiri Village, we can find that palm oil trees thrive in backyards of farmers. One of the locals in this village already has his palm oil plantation, with approximately about 100 palm oil trees. He just cultivated the palm oil seed and then the palm oil trees grew up without any fertilizer and maintenance. If these palm oil trees produce fresh fruit bunches (FFB), locals pick them up and cook the fruits into a variety of dishes. Rods and woods of palm trees are use as firewood for everyday cooking. Farmers know that FFB can be sold in the market for money but, to sell the FFB, they need to incur an expensive transportation cost to Mamuju City.

In the Kamiri Village, many young people are the unemployed, even with the college education. The unemployment of young generation with the educational background at universities in Makassar caused by the scarcity of job opportunities and a high cost of living in the city. The other reason that they are

back to the village is to help their parents as temporary agricultural workers. Some of them went to Mamuju, Kalimantan, and Malaysia as workers in palm oil plantations.

### **3. Findings of The Field Study.**

This section gives the detail description of the field study. The responses through the discussions in it showed that biodegradable plastics especially PHA, was entirely new to the locals. The old generation people in the local communities were interested in R&D and manufacturing of PHA for the reason of creating job opportunities for the young generation. But, other participants did not speak out their interest. The focus of the discussion was a job creation for young generations, and an efficient use of unproductive land was also the reason to accept my idea. There were behaviour differences between the old generation and the young generation. The young generation was interested in this business to increase their income. Responses in the community symposium show that the local community does not concern the different wage levels of workers at various divisions of the firm because they are very grateful just for that a plantation company comes to open a new business in their area. These suggest strongly that a mere existence of strong peer effect is not enough for a PHA production to be successful in this area.

The discussions in the community symposium revealed that farmer groups were very glad to attend the symposium because this was the first time for them to hear about a palm oil plantation and manufacturing of polyhydroxyalkanoates. Biodegradable plastics, especially PHA was entirely new to the locals. They only knew conventional plastics, which they used in their daily activities for the household appliance. They understood the dangers of disposing of conventional plastics that would lead to environmental contamination. In their daily life, they usually throw away plastic waste anywhere on their home yards. They sometimes found the plastics inside the intestines of cows, which would be dangerous if a human consumes cows beef.

In the discussion at the community symposium, the old generation people including the heads of farmer groups, secretaries of farmer groups and elders of farmer groups became very interested in R&D and manufacturing of PHA, for the reason of creating job opportunities for the young with a college education in Makassar. Furthermore, they said that there were vast lands in the village, which were not used for any agricultural production but would be suitable for a palm oil plantation. The other reason to accept the business was an increase of income. Participants told that they were enthusiastic and would like to learn about fermentation of PHA in a laboratory. Locals believed that the texture of the soil, the climate, and the shape of the region in their areas would be suitable for a palm oil plantation. The village is near the river and the port that will allow the transportation of CPO products elsewhere.

The locals were not concerned about the different wage levels of workers in different divisions of the firm because they were very grateful just for that a plantation company would open a new business in their area. Local people were very hopeful that the business plan would be realized immediately. They wished that the abundant natural resources in their area could be utilized by a

big industry that would involve them as workers in palm oil plantations and R & D and manufacturing of biodegradable plastic PHA.

Most of the young generation disregarded of different wages for different jobs in the firm because they did not understand the full picture of the business. Only the old generation understood the business and the necessity of a different qualification for R&D job. Other locals did not show an interest in R&D and manufacturing of PHA.

The response of local community in 5 informal interviews shows that locals wish that this business plan would immediately realize. There was an enormous expectation for job opportunities to the local communities by employments in palm oil plantations as well as the R & D division as researchers. They believed that, if this business operated at their location, it would enhance their livelihoods and welfare. One old farmer told that farmers wanted a benefit of health insurance from the firm. He also told that there should be a job differentiation by qualifications that the young generation with a college education should apply for the R & D jobs and others would be appropriate only for plantation works. Four locals who were close to old generation showed a desire for a double income opportunity through an employment of the housewife in the palm oil plantation. Furthermore, one old farmer agreed on sharing of knowledge and experience with workers from outside. He also expected social contributions by the firm to the local communities. He said that the firm must establish a free school for children in their location. The other old farmer was interested in a positive contribution to environmental issues in the idea of installing the biomass power generator of the palm oil mills effluents.

#### **4. Assessment on The Hypothesis.**

The discussions in the community symposium show that R&D and manufacturing of PHA are new to the locals and that only the old generation people in the local community are interested in R&D and manufacturing of PHA, to increase the job opportunities for the young generation with the college education and use unproductive lands in this village. The young generation was interested in this business merely to increase their income. Most of the young generations have educational backgrounds in universities, but they are unemployed. Therefore, the local community is very grateful that a company comes and operates in their area, and locals did not concern about wage differentials. Under these circumstances, the old generation will be able to push peer effects in local communities. There was some evidence of a strong peer effect in this village. This evidence was respect from the young generation to the old generation and letting the young age have college educations following the other locals. However, I did not find an entrepreneurship in the young generation. The spirit of entrepreneurship came only from the old generation. A strong peer effect from the old generation would not be enough to install palm oil plantation with R&D and manufacturing of PHA in this area because the old generation will not work for manufacturing or R&D. The local community is just waiting for the business to come to their village, and there is no initiative in them for R&D and manufacturing of PHA. The local community just wishes to receive a positive contribution to the society from the business. These observations

suggest that there is a problem in mechanism to create peer effect in the local communities. Namely, peer effects are likely to come from a kind of coercion from the old generation. The coercion has a negative impact on morale, which is very important in R&D jobs. The cooperative behaviour of locals under a peer effect is not important in palm oil plantation jobs. Hence, the existence of peer effects is not working positively to improve human capital in this area. A mechanism to create a peer effect seems to be crucial to promote a high morale in the short-run and scientific knowledge in the longterm.

## **5. Conclusion**

There are two conclusions in this research. First, a mere existence of a strong peer effect in a local community is not enough to install palm oil plantation with Research & Development and manufacturing of Polyhydroxyalkanoates in the Kamiri Village. Secondly, The positive correlation among a cooperative behaviour, morale and an improvement of scientific knowledge are weak at best in this area. The analysis of data suggests that there is coercion from the old generation to the young generation in the local communities. In general, coercion has an adverse impact on morale for work. The analysis also suggests that the spirit of entrepreneurship in local communities comes only from the old generation, though that comes from the younger generation is needed in the R&D division. The mechanism to create a peer effect seems to be crucial to bring a high morale for work in R&D division in the short run.

## **References**

- Sudesh K (2013) Polyhydroxyalkanoates from Palm Oil: Biodegradable plastics, springer briefs in microbiology, DOI: 10.1007/978-3-642-33539-6-2. p:1-2.
- Urtuvia Viviana, Villegas Pamela, Gonzales Myriam, Seeger Michael (2014) Bacterial production of the biodegradable plastics polyhydroxyalkanoates, international journal of biological macromolecules 70: 2018-213.
- C.S.K. Reddy, R. Ghai, Rashmi, V. C. Kalia (2002) Polyhydroxyalkanoates: an overview. Review Paper. Bioresource Technology. Elsevier Science. Ltd 87(2):137-46. DOI 10.1007/s00253-011-3102-0.



**Topic :** Agriculture

**INTEGRATION OF SLC (SOCIETY LIVESTOCK CENTER) WITH  
PENTAHHELIX SYSTEM AS AN INDONESIAN STRATEGY IN  
LIVESTOCK DEVELOPMENT AND FARMERS EMPOWERMENT  
TOWARD AEC (ASEAN ECONOMIC COMMUNITY)**

**Ramadhan Febriansyah, Sarah Novianti, RudiYansah\***

*Padjajaran University, Jalan Raya Jatinangor-Sumedang KM 22, Sumedang 45363,  
Indonesia*

---

**Abstract**

To improve independence, providing convenience and progress of business, and also to improve competitiveness and welfare of farmers, especially to towards AEC (ASEAN Economic Community), needs to be a strategy of the Indonesian government. Currently, the government of Indonesia has launched a program of SLC (Society Livestock Center). SLC is a growth center in area livestock commodities as a medium farm livestock development and animal health in which there is a certain population of animals owned by the majority of farmers who live in a village or more. SLC program will run as expected if it involves various elements of a public institution or non-profit to realize the Indonesian government innovation. This research conducted means of literature study, which authors find and compare the secondary data obtained from journals, textbooks and scientific article which reliable relevant Literature which used contains an explanation of the SLC and an explanation of the system Pentahelix and we try to analyze that for improving this idea and support this idea for implementation. SLC is a government program in the livestock sector, authors offer an idea to integrate the SLC with Penta helix system (academy, government, business, media and community). It is to collaborate all of the above elements to improve competitiveness, welfare and autonomy of Indonesian farmers to towards AEC. The impacts of integration of SLC with Pentahelix is to get the sovereignty on food, and improving competitiveness of farmer in AEC era.

**Keywords:** *Asean Economy Communities, Pentahelix, Society Livestock Center.*

**1. Introduction**

The formation of the ASEAN Economic Community (AEC) has purpose to increasing welfare of all ASEAN members. This is a significant progress as a respond to care of human security include economy security. As one of the main three ASEAN communities 2015, ASEAN Economic Community formed with the mission to make economy in ASEAN get better and also the member of ASEAN can competes with developed countries in regional and global scope. There five things as a critical points of ASEAN

---

\*Ramadhan Febriansyah. Tel.:+628986952065;  
*E-mail address:* ramadhan14001@mail.unpad.ac.id

Economic Community: free flow of goods and services, skilled labour, free flow of foreign direct investment fund and capital. All country will cooperate and compete each other regarding to that five points. This moment can be an opportunity or a threat for Indonesia depends on capability of government to prepare a competitiveness of the societiespecially in the productivity of livestock.

However even we are facing food security, the government not only have a responsibility to fulfill the people needs on food as what Nawacita's program, but also commit to optimize the productivity of livestock. Therefore we can compete in livestock field in the ASEAN Economic Community Era. Currently SLC (Society Livestock Program) has launched by government but it has not familiar and being optimum yet. In the Nawacita program belong to Mr. President Joko Widodo, one of the goals is Indonesia must have food sovereignty. But we still import meat, chess, and livestock products from Australia and others. How can we compete in AEC era if we cannot fulfill our needed selves on livestock product?

Therefore, to improve independence, providing convinience and progress of business and also to improve competitiveness and walfare of farmers toward ASEAN Economic Community, we all have to support this by creating and proposing a new innovation to achieve success in AEC. That is integrating of Social Livestock Center with pentahelix system. This successness can be following by the power of people to work together in mutual cooperation (*gotong royong*) related to pentahelix concept that elaborating five key sectors. The five key sectors are citizen, government, privat, university, and non-profit association.

Application of the pentahelix model has introduced into development program of Eastern Croatia region, as well as the whole Republic of Croatia. The pentahelix system was success applied in Croatia. This system applied through partnerships and cooperation by engaging in business investments in opening new plants and facilities, the introduction of modern technology, to create new employment opportunities and it can stops the emigration of young people, who are increasingly looking to other countries in terms of quality of life and dignity for themselves and their families. This concept can be adopting in Indonesia according the problem of the Indonesian citizen in rural area seeking for job as a hard worker in many company, or eventually seeking a job up to overseas as TKI (*Tenaga Kerja Indonesia*) and they pay very low.

## 2. Method

The method used in this research is using the study of literature. This method using read and record technic. This technic is a collecting data by searching the data from journals, textbooks, and scholarly articles. Starting from the stage of formulation of the problem, data collection, data analysis of the literature obtained. At the stage of formulation of the problem is to look for any problems and obstacles associated with the program people farm centers are integrated with the Pentahelix system as an Indonesian strategy to toward ASEAN Economy Community (AEC) so that it can be used as supporting their stabilizing farming and to competed Asean. The next step after collecting data from the literature is information about the SLC program in Indonesia that has been running, the system Penta helix that has been launched as well as data on the implementation of ASEAN Economy Community (AEC). SLC program facilitated by Direcrotate Livestock and Animal Health guidelines issued by the People's Ministry of Agriculture of the Republic of Indonesia in 2015.

Once the data is collected the next step is to analyze the extent to which the SPR program that is integrated with the Pentahelix system in ASEAN Economy Community

(AEC) program so that it can be used as a support for food sovereignty. Then the results of the analysis will be the basis for creating a policy and initial conclusions that will be able to support the design of this author. In the process of realization of the program approaches must also apply to elements that can provide such influence in Penta helix namely: the academy as a mentor in the program SLC, the Government as a supervisor and set regulations, Privat as a supporter in the program SLC, Media as a tool to publish so the SLC program is clearly visible, and the community of people who are members of the SLC program.

### 3. Results and Discussion

- *The condition of Indonesia Livestock in the era of AEC*

With the implementation of AEC challenge and the competitiveness of various sectors is increasing, including in the livestock sector. In realizing its mission of AEC agreed on several pillars one of which is a single market and production elements of the writing of this time will be mentioned about the free flow of goods, the free flow investment and the free flow of skilled labor. At the free flow of goods, this element is one of the AEC Blueprint main element in realizing the AEC by the power of a single market and production base. With the mechanism of the free flow of goods within the ASEAN region is expected to be ASEAN regional production networks formed by itself. The free flow of investments in AEC has the main principle in enhancing the competitiveness of ASEAN and create a conducive investment climate in ASEAN. In the current skilled workforce provides greater opportunities for citizens of ASEAN countries to come and go from one country to another to get a job without any obstacles in the country of destination. (Towards AEC in 2015, the Ministry of Trade)

Analyzing the above that one of the most important in the face of the AEC improves the competitiveness of one of them in the livestock sector through the development and empowerment of farmers. The condition of Indonesian farmers are now, breeders scale people with limited skills and low education levels, as shown by the following data (Livestock Statistics 2015, DG Agriculture Livestock Ministry of Indonesia)

Condition farms Indonesia is now in the sector of investment, domestic investment by foreign investment relative increase with the amount of domestic investment in 2014 amounted to Rp. 650 million more, if we compare it with foreign investment are much greater that in 2014 amounted to 30 618 US \$.

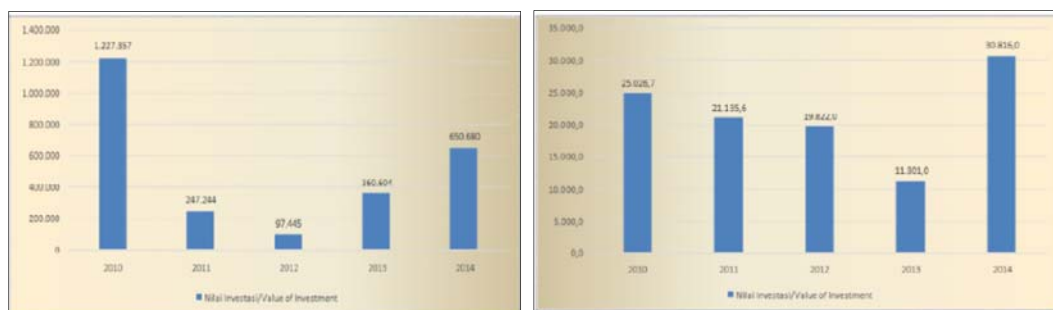

Figure 3. Employment by education attainment of livestock year 2012-2014

No	Pendidikan Tertinggi Yang Ditamatkan/ Educational Attainment	Tahun/ Year					
		2012 <sup>1)</sup>		2013 <sup>1)</sup>		2014 <sup>2)</sup>	
		Februari	Agustus	Februari	Agustus	Februari	Agustus
		February	August	February	August	February	August
(1)	(2)	(3)	(4)	(5)	(6)	(7)	(8)
1	Tidak/belum pernah sekolah/ No Schooling	667.084	688.477	593.770	702.243	564.028	640.862
2	Belum/Tidak Tamat SD/Did not complete/ Not yet complete Primary School	974.872	1.093.350	1.037.385	1.140.913	927.644	1.050.190
3	SD/Primary School	1.418.820	1.606.823	1.582.390	1.729.433	1.560.074	1.521.832
4	SLTP/Junior High School	596.266	565.344	638.784	701.100	707.971	570.873
5	SMA/Senior High School (General)	199.825	208.250	219.919	258.781	213.556	229.625
6	SMK/Senior High School (Vocational)	123.892	131.091	155.631	117.184	157.444	136.581
7	DIPLOMA I/II/III / Diploma I/II/III/Academy	13.311	17.728	29.426	13.790	10.545	15.685
8	UNIVERSITAS/DIV/University	33.493	30.783	33.230	27.629	28.300	24.273
Jumlah/Total		4.027.563	4.341.846	4.290.535	4.691.073	4.169.562	4.189.721

Sumber/Source : Badan Pusat Statistik-Data Mentah Survei Angkatan Kerja Nasional (SAKERNAS) diolah oleh Pusdatin Kementerian Pertanian/BPS-Statistics Indonesia-Raw Data National Labour Force Survey (Sakernas) processed by the Center for Data and Information System for Agriculture - Ministry of Agriculture

<sup>1)</sup> Data tahun 2012-2013 merupakan data hasil backcasting dari penimbang proyeksi penduduk tahun 2010-2035/Data in 2012-2013 are data backcasting results of weighing the population projection of 2010-2035

<sup>2)</sup> Data tahun 2014 menggunakan penimbang hasil proyeksi penduduk tahun 2010-2035/Data 2014 using the weighing results of the population projection of 2010-2035

Figure 4. (a) Value of Livestock Domestic Direct Investment 2010-2014 (Million Rp), (b) Value of Livestock Foreign Direct Investments 2010-2014 (thousand US\$)

For facing the ASEAN Economy Community Indonesian government has prepared a strategy in general, namely:

1. The adjustment, preparation, and regulatory improvements both collectively and individually (regulatory reform).
2. Improved quality of human resources in both the bureaucracy and the business or professional.
3. Strengthening the position of medium-scale enterprises, small and business in general.
4. Strengthening the partnership between the public and private sectors.
5. Creating a conducive business climate and reduce high-cost economy.
6. The development of priority sectors that have broad impact and commodity.
7. Increasing the participation of government and private institutions to implement the AEC Blueprint
8. Institutional reforms and governance. In essence the AEC Blueprint is also a joint reform program that can be used reference in ASEAN countries, including Indonesia, and
9. Provision of institutional and capitalization that is easily accessible to businesses of all sizes. (The book Towards AEC 2015, the Ministry of Trade).

Analyzing the above general strategy in the face of AEC. SLC formation which has been integrated Pentahelix as a strategy to develop the ranch Indonesia and bamboozle farmers it has been consistent and supportive of the efforts into it. Where SLC depart from the philosophy that the development of animal husbandry and veterinary welfare of the people breeder can only be Achieved if the government and the parties do everything to Observe the principles of management, organization (consolidation) perpetrators, and empowerment of farmers in order to Realize the livestock population planning.

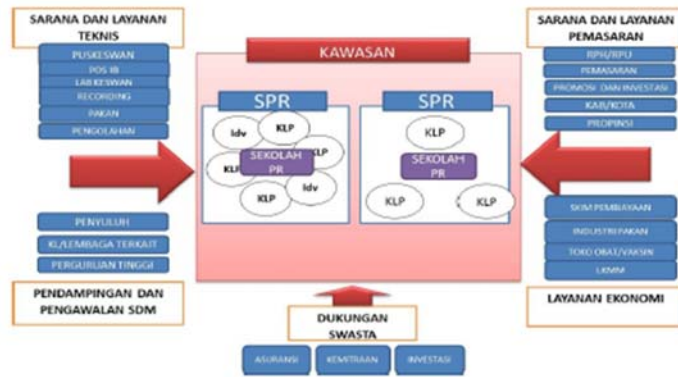

Figure 1. Mindset Development Conception SLC

SLC optimizing resource utilization of funds and resources towards the collective business of all parties, namely the facility of:

1. The Directorate General of Livestock and Animal Health in the form of infrastructure and technical services;
2. Local Government in the form of infrastructure and marketing services
3. Academics, Researcher, and Development Agency, the Agency Human Resources Development in the form of a guard and mentoring resources
4. The Ministry / Related Institutions in the form of economic services, and
5. Private form of insurance, partnerships, and investments. *Sekolah Peternak Rakyat* (folk farm school) is a lever and agents of change in the management of institutional and human resources towards the establishment of a farm livestock business collective of independent and profit-oriented businesses through mentoring, start up, and information technology applications, the transfer of knowledge. School attendance Folk Breeder in SLC become important as a place to create awareness of knowledge transfer skills improve breeding is good and true. (SLC Guidelines DG Livestock and Animal Health, 2015).

The main purpose using SPR to build farms and animal health in Indonesia is as follows:

1. Create a livestock business people in a collective enterprise that is managed under one management;
2. Improving the competitiveness of farm people through increased knowledge, awareness, and strengthening the skills of farm people;
3. Establish a database of information systems to compile the livestock population planning;
4. Increasing people's income and welfare of farmers; and improve the ease of technical and economical services for farm people (SLC Guidelines DG Livestock and Animal Health, 2015).

Analyzing the above, the mind set of the conception of the development of SPR adopts itself Pentahelix, where there are five elements involved in the conception of the development of SLC with the adjustment. Basically, according to (Lindmark, Sturesson & Roos, 2009: 24) is an extension of the triple helix strategies by involving the various elements of the community or non-profit institutions in order to realize innovation. In this case, the collaboration of five elements has its respective role towards food sovereignty in livestock commodities. First, central and local governments, as well as the Director General of Livestock and Animal Health, has a role in the form of technical service facilities, maker of regulation in favor of the farmers in the SLC and funding.



Figure 2. Collaboration Strategy Pentahelix

**Second**, academics play a role in human resource development in the form of a guard and mentoring of human resources, so as to improve science and technology and skills of farmers. **Third**, the community in question, in this case, the SLC in an area that has been designated as the object (farmers) who will develop knowledge and skills through SLC. **Fourth**, the media has a role in the documentation and publications in the mass media to the benefit of the dissemination of information to the public relating to these SLC following with products in an SLC making it known to the public. **Fifth**, the businessman has a very vital role which is as well as marketing of livestock fund distributor farm products to the public. Step formation integrated SLC Pentahelix is one of the programs implemented by President Joko Widodo during his reign as one of Indonesia in the development of strategies at the farm and the empowerment of Indonesian farmers in the face of AEC.

### Acknowledgement

The process of writing this paper has been an interesting three week journey. This paper will be a foundation of innovation for livestock policy by integrating Society Livestock Center with Pentahelix System as strategy to overcome livestock issues toward ASEAN Economic Community. On our way to a finished paper, we have sharing with lecture who has given inspiration, useful thoughts, theories and guidance along the way. Thank you for the Padjadjaran University, the Government of West Java Province, Faculty of Animal Husbandry, Faculty of Social and Political Sciences of Padjadjaran University, Rumah Zakat, IKA (Union of Alumni) of Padjadjaran University, our parents who have support in financial and any aids.

### References

- According to vision, mission and action rogram of new Indonesian president in 2014 Mr. Joko Widodo and Mr. Jusuf Kalla.
- According to the report of impact ASEAN Economic Community toward Industry, Service and Labour Sector in Indonesia.

- Bustami, Gumardi. (2015). Menuju ASEAN Economic Community 2015. Trade Departement of Indonesia Republic.
- Wagiran. (2012). Mewujudkan Paradigma Vocational Education For All Melalui Strategi Kerjasama Sinergis . In Proceedings of International Seminar Reformulating the Paradigm of Technical and Vocational Education 2012 , UNY, Yogyakarta, Indonesia.
- Lindmark, Adam, Markus, and Elof. (2009). Difficulties of Collaboration for Innovation: A Study in the Oresund Region. Lund University: School of Economic Management.
- Muadno. (2015). Pedoman Peternakan Rakyat (SPR). Direktorat General of Livestock and Animal Health of Agriculture Ministry of Indonesia Republic.

Topic : Social Sciences and Sustainabilities

**A Consideration of Expectations in Nursing Education Regarding  
Relationships with Patients**

– Main Focus on Textbook Analysis of  
High School Nursing Departments–

**Junko NANAHOSHI**

*Graduate School of Humanities and Social Sciences, Chiba University, 1-33 YayoiCho,  
Inage-ku, Chiba-shi, Chiba, 263-8522, JAPAN*

---

**Abstract**

In recent years, care work has become internationalized, and, since 2008, foreign nurses have been accepted through the Economic Partnership Agreement (EPA) in Japan. There are, however, various problems in accepting nurses from overseas. One problem is the language barrier, which not only comes from difficulty with Japanese grammar, but may also affect communication and relationships between nurses and their patients. Good relationships improve the quality of care provided.

This paper aims to discuss how nurses have been educated to form relationships with their patients in Japan. The high school nursing courses in Japan use four textbooks that are authorized by the Ministry of Education, Culture, Sports, Science and Technology. In analyzing the sections of the textbooks regarding the relationship between nurses and patients, we found that nurses were required to be accepting and empathetic toward patients. In addition, comparing the contents of some textbooks before authorization and those of the four authorized books, we noted that the nature of nursing had become gradually more specialized. Nursing principles have changed from those that are one useful for both professional nurses and ordinary people taking care of their families to principles directed toward professional nurses only. As the nature of nursing becomes more specific, empathy toward patients is regarded as significant. A closer look at the relationship with patients in the nursing curriculum will lead to a better understanding of the nursing care expected by society.

**Keywords**

Nursing education, Relationship with a patients, Communication, Textbook, Empathy

---

**1. Introduction**

In recent years, the declining birth rate and aging population in Japan, and problems of how care is provided, both everyday and occupational, in a co-operative manner have been considered in various domains. Furthermore, globalization of care work is also one of these issues, and since 2008, foreign nurses have been accepted through the Economic



Partnership Agreement (EPA) in Japan. There are, however, various issues concerning accepting nurses from overseas. One issue is the language barrier, which not only comes from difficulty with Japanese grammar, but may also affect communication and relationships between nurses and their patients. Good relationships improve the quality of care provided.

This paper aims to discuss how nurses have been educated to form relationships with their patients in Japan. How to connect with patients in nursing is one aspect of how people form relations with others. How people form relationships with others varies depending on the society involved. Therefore, while dealing with nursing education in this paper, this issue will be considered from the point of view of care in the community and society. As the first stage to investigate this, changes in education in nursing are addressed. Therefore, this paper reports an investigation into coverage of the relationship with the patient in high school textbooks.

## **2. Methods**

Reasons for examining textbooks are explained. Textbooks are a source of information for education. They are intended to comment clearly on standard knowledge at the time (Yamazaki, Roppongi 2005: 29). In addition, textbooks are a factor that connects expert on nursing and those who are going to learn about nursing, so they provide clues about the image of nursing and the expectations of nurses at a given time. Therefore, textbooks are targeted in the analysis.

Furthermore, high school textbooks are targeted in this paper. This is because, although many nursing textbooks are published, they are the only textbooks that are authorized by the Ministry of Education, Culture, Sports, Science and Technology (MEXT). This would mean that these textbooks are designed and standardized to reflect the way nursing education has been institutionalized by the state. Moreover, a previous study examined Japanese nursing textbooks, but few studies have examined high school textbooks. In addition, the kind of textbook used deals with general statements about nursing rather than practical nursing techniques. Furthermore, the sections of the textbooks regarding the relationship between nurses and patients are analyzed by discourse analysis. The target textbooks of high school nursing courses are the 1966 version, 1967 version, 1974 version, 1979 version (these 4 textbooks date from before official approval began), 1982 version, 1995 version, 2003 version, and the 2013 version.

## **3. High School Curriculum Guidelines For Nursing**

According to the description of the nursing education system in Japan as provided by MEXT, nurse qualification is given to the person who passed the national nursing examination. There are several courses offered to obtain the eligibility to take this examination, which are largely classified into three: (1) 3-year course in junior college or nursing school or 4-year course in university after graduation from high school; (2) 2-year course after qualified as a licensed practical nurse; (3) 5-year course in the Department of Nursing of high school. Among these three courses, the third one is the shortest way to obtain the nursing qualification. Therefore, this course is regarded most suitable for those who have already been determined to become a nurse at their enrollment in high school.

Regarding high school nursing education, courses teaching nursing were organized for licensed practical nurse training in 1964. The educational context lacked nursing workers and required education promotion for girls in high school (Nkajima, Maehara

1973, Kimura et al 2006). Furthermore, a non-degree graduate program was established in 1968, and consistent education began in 2002 for five years.

The guidelines are reflected in the learning curriculum in high school. The sections of the school course regarding the relationship between nurses and patients are examined from changes in the guidelines from the 1972 version through to the 2010 version (1972 version, 1979 version, 1989 version, 2002 version, 2010 version).

- 1972version “Nursing and personal relationships”  
“It deals with human relations in nursing and a method of transmission of the will, lets you understand the significance and importance, and lets you think about the influence that human relations have on the duties of nursing.” (emphasis added) (1972 version: 8)
- 1979version “Human relations of a nurse and the patient”  
“lets you understand how to contact the patient of the nurse and lets you think about the influence that human relations have on nursing” (emphasis added) (1979 version: 19)
- 1989version “Human relations of a nurse and the patient”  
“lets you learn human relations necessary to nurse and basic knowledge and techniques about the communication.” (emphasis added) (1989 version: 19)
- 2002version, 2010 version “Human relations with the patient”  
“Based on a basic understanding of human relations in everyday life, it lets you learn the characteristics of human relations with a patient and a healthcare worker and nurses, helps you understand that being able to maintain a good relationship is the foundation of nursing practice (emphasis added), and it lets you learn basic knowledge and techniques about communication to build a relationship of mutual trust. In addition, it lets you learn about human relations with the family of the patient.” (2002 version: 24-25)

In this way, the focus changed from human relations that surround nursing to patient-centered human relations. In addition, human relations varied from a thing that influenced one’s duties to the basis of nursing practice. We found an emphasis on human relations and the importance of communication in high school nursing courses education.

Kaji et al (2015) analyzed education in communication as a nursing technique and addressed the relevant changes. They arranged a description of the contents of texts on nursing techniques from the Meiji era to the present age. The target of nurses’ communication gradually spread through the family of the patient, and other medical personnel as well as the patient and the doctor. They point out that communicative competence becomes necessary and important for nurses and communication gradually came to be taught as one of the techniques to establish a relationship of mutual trust.

However, the high school textbooks were not included with the textbooks that Kaji et al. intended. In addition, Kaji et al. pay attention to the concept and significance of communication, but do not address the techniques of communication. Therefore, the contents of textbooks focus on communication.

#### **4. Communication in the nursing**

This section explains how the communication in nursing is described in textbooks. Particular focus is on how the description of positioning of communication, nurses’ approach to patients and communication methods has changed over the last 50 years.

#### 4.1. *Positioning of the communication*

First, the passages and their contents dealing with the communication in nursing are described as follows.

- 1966version, 1967version  
“Educational role of the nursing”  
“Education encourages human beings to change the actions of others. The scene of the nursing, such an educational encouragement accounts for a significant part. The educational encouragement is carried out through communication in various scenes.”(1966version:222, 1967 version: 222)
- 1974version, 1979version  
“Nursing and personal relationships”  
“Indispensable elements for the progress of nursing activity include definitely about understanding the patients thoughts and complaints, giving explanation as needed, and getting the understanding of the patient about nursing. In such a meaning, it may be said that the communication accounts for an important part in nursing.” (1974version:77, 1979 version: 77)
- 1982version(Basically the same thing is written in the 1995 version)  
“Establishment of the relationship of mutual trust of the nurses and the patients”  
“The patient conveys something to a nurse through verbal communication, by a position or movement from an expression, or a gesture. The nurse also communicates in the same way to motivate and encourage the patient.” (1982 version: 229)
- 2003version (Basically the same thing is written in the 2013 version)  
“Establishment of the relationship of mutual trust of the nurses and the patients”  
“Through smooth communication between a patient and nurses, relationships of mutual trust are built between them, Therefore, nurse understands the methods to advance communication smoothly, and it is necessary to acquire the technique.”(2003 version: 221)

In the 1960s, communication was placed as a tool for educational encouragement, and in the 1970s, it was described that the nurses listened to the complaints of patients properly and responded to it by making the necessary correspondence to provide care. In the 1980-1990s, rather than communication being a means for accomplishing nursing activities, a psychological approach to the patient was suggested. In the 2000s, communication has been described as a technology needed to create a trusting relationship. The positioning of communication has changed from a focus on education and observing to communication becoming an end in itself.

#### 4.2. *How nurses approach patients*

This section describes how nurses approach patients; what has always been regarded as important throughout the decades, and what was newly added.

- Atmosphere building  
In smooth communication with the patient, there is a point where the nurses’ function is explicitly stated. In any version, atmosphere creation is cherished.

“An important function of the nurse is creating an atmosphere in the place where communication occurs; also, to the nurse encourages a supportive atmosphere so that the patients can easily express themselves.” (1982 version: 232)

“It's important for a nurse to ease the patient's tension and anxiety through understanding the hobbies and topics that they are interested in, and provide an environment that makes it easy for them to communicate.” (2013 version: 248)

Creating an atmosphere that encourages patients tend to communicate was also seen in the 1970s, but was not seen in the 1960s.

- Individual correspondence with patients (From the 1980s)

“People have individually different personalities, and different ways of reacting to becoming sick. Nurses tend to see things from a fixed view point, such that they see the patient in general terms.” (1982 version: 231)

“Even if the patients receive the same treatment, such as hospitalization for the same disease, it is individually different and they have their own personality, such as a family, an occupation, character, their own sense of values, and vary in their reaction to becoming sick.” (2003 version: 222)

- Interest and empathy

“Nurses can convey that they continue to show interest in the patient by hearing about their condition while adding what they have noticed about the patient.” (1982 version: 232)

“What the patients demand is that there is a human being nearby, while noticing their feelings and the changes they experience, empathizing, and accepting their feelings.”(2003 version: 222)

Creating an atmosphere that encourages patients to talk freely is dealt with in all versions, and it is important when nurses contact a patient. Viewpoints that stress acknowledging the individuality of the patient have become increasingly prevalent. Not only showing interest in a patient, but also accepting and empathizing with the patient is expected, and it is understood that nurses will treat a patient more positively.

#### 4.3. *Communication methods*

This section focuses on the communication methods. There were no item of communication technology items in textbooks before receiving official approval, but corresponding items can be found in them. After receiving official approval, textbooks refer to an item called communication technology. Firstly, corresponding items found before receiving official approval are introduced; for textbooks published after official approval, this section focuses on the point where a change occurred. Although not examined here, techniques known as "hears stories well" and "the coherent manner" were also introduced.

The 1966 and 1967 versions of the textbook includes items such as “type of communication” and “Understanding what the patient expresses.” At that point “the manner of representation of the nurse” has been described as “having a sense of stability,” “Consciously bear in mind the need to take action, such as helping in the guidance of the patient,” and “strive to clearly communicate feelings in plain words” (1966 version: 224-225). In the 1974 and 1979 versions, it is written that at the time of communication with the patient, the nurse may have to be particularly careful to “Listen,” show a “Friendly attitude,” and “use words that the patient can easily understand correctly”

(1979 version: 76-77). Next, textbooks published after receiving official approval are described.

- Do not take the evaluative attitude(1982-2003version)  
Explaining why a nurse would take an evaluative attitude

“Nurses is also human being, therefore, they cannot always avoid judging the patient’s expression from a standard of right and wrong and show a critical manner.” (1982 version: 234)

“The nurses evaluate the behavior of the patient by common sense and their own moral judgments and this may prevent patients from saying what they want to say.” (1982 version: 234)

- Empathetic attitude(only 2013version)

“When a patient wonders why he/she only is suffering from such a thing (for example, serious illness; emphasis added), the nurse who supports the patient empathizes with the thoughts of the patient and their family, and it is necessary for nurses to maintain and improve their motivation for medical treatment” (2013 version: 250)

“When patients cannot keep instructions of the prolonged dieting and rest, the nurses does not criticize it and empathizes with the feeling of such them, with that in mind, the nurse thinks with the patients and families how they can send better medical treatment life and it is connected by patient’s own for the health care that can continue after a discharge.”(2013version:250)

Thus, until the 2003 version, nurses were portrayed as having issues with evaluation, so there was an image that nurses did not tend to make patients talk to them. This is also considered a reflection of the idea that educational attitudes in the 1960s had gone too far.

In the 2013 version, “Do not take an evaluative attitude” was changed to “empathetic attitude.” The position where a nurse understands the patient sufficiently from his or her perspective is referred to as an “empathetic attitude” rather than one of judgment. So, this can be regarded as a change from “Do not take an evaluative attitude.” Furthermore, it suggests also that the evaluative image of nurses has become less prominent. In the 2013 version, references to the “empathetic attitude” were joined by a focus on more emphasis capturing the patient’s feelings; however, the sentence “nurse who is also a human being” is not found. For nurses are also human beings, and as such are prone to make judgments, such as about good and evil, and to criticize patients, but these issues have not been addressed.

This might be related, along with attention, to the care concept. In the 1970s and 1980s, a word ‘care’ received much attention in the area of nursing. One of the backgrounds of this concern is said to be that the quality of life came to be discussed in the context of high economic growth and advanced technology (Tutui1993). In addition, it is said that with the development and spread of medical technology, there has been a transformation of the nature of disease, such as the increased prevalence of people with chronic diseases associated with the increase in the survival rate, and the development of medical technology has triggered that human life is undervalued in the medical field (Japan Nursing Association 2007: 13). Due to the increase of chronic diseases and the death in hospitals during the 1950-1970’s, the idea has developed that “Whereas previous medical practice tended to focus attention only on the disease and body surface, there is a need for a more “holistic” approach.” (Mitsui 2006: 52). In this way, this is also considered to reflect emergence of the thesis “from cure to care” associated with the development of medical technology and changes in the disease structure.

## 5. Conclusion

This paper aims to discuss how nurses have been educated to form relationships with their patients through high school textbooks. In the foundation of high school education, there has been a gradually increasing emphasis on continuing to improve the relationship with the patient, developing to the point where communication is regarded as essential, a finding similar to that of previous studies.

In addition, this study revealed changes in the purpose and technology of communication over the last 50 years. As communication continues to be emphasized, the goal is to create a trusting relationship with the patient. For this reason, a change has been observed in that communication has become its own purpose. Specifically, there is not so much attention on how nurses speak to patients, and there are technical aspects that emphasize (1) treating the patient individually; (2) the patient is likely to convey their thoughts; (3) accept the patient, and be empathetic to their feelings. In this way, nurse education trains them to create a trusting relationship with patients while communicating so that they treat the patients individually, and are receptive and empathetic.

## 6. References

### ○Textbooks

<1966 version>

Abe Masakazu, Hinohara Sigeaki, Kaneko Mitu ed. (1966). Koutoukangogaku1 Kangosouron(High school nursing1 Nursing general remarks), Igakushoin, Tokyo (In Japanese).

<1967 version>

Abe Masakazu, Hinohara Sigeaki, Kaneko Mitu ed. (1967). Koutoukangogaku1 Kangoippan1 (Kangosouron · Shikujirouhou) (High school nursing1 Nursing general1 (Nursing general remarks · Diet) ), Igakushoin, Tokyo (In Japanese).

<1974 version>

Fjieda Chikako et al. (1975). Kangogaisetu (Nursing overview), Igakushoin, Tokyo (In Japanese).

<1979 version>

Fjieda Chikako et al. (1979). Kangogaisetu (Nursing overview), Igakushoin, Tokyo (In Japanese).

<1982 version>

Ministry of Education, Science and Culture. (1982). Kisokango (Basic nursing), Medikarufurendosya, Tokyo (In Japanese).

<1995version>

Ministry of Education, Science and Culture. (1995). Kisokango (Basic nursing), Medikarufurendosya, Tokyo (In Japanese).

<2003 version>

Ministry of Education, Culture, Sports, Science and Technology. (2003). Kisokango (Basic nursing), Jikkoyusyuppan, Tokyo (In Japanese).

<2013version>

Ministry of Education、 Culture、 Sports、 Science and Technology. (2003). Kisokango (Basic nursing), Kyouikusyuppannsya, Tokyo (In Japanese).

Japanese Nursing Association ed. (2007). Kangonikakawaru syuyounayougo kaisetu –gainetekiteigi, rekisitekihensen, syakaitekibunmyaku – (Explanation of key terms related to nursing – Conceptual definition, historical changes, social context–), Japanese Nursing Association, Tokyo (In Japanese).

- Jougahana Hatuko, Okawa Makiko, Inoue Miyoe. (2016). Nursing Theory–History, Present state and Prospective, *Seisen J. Nurs.Stud*, Vol.5, pp.1-12, Shiga (In Japanese).
- Kimura Mayumi, Abo Shouko, Ohgushi Yasuko, Koyama Atuyo. (2006). Study Concerning the History of Educational in Aomori Prefecture : The Transition of the Department of Health Nursing in High School, *Hirosaki Gakuin University nursing Bulletin*, Vol.1, pp33-39, Hirosaki (In Japanese).
- Ministry of Education, Science and Culture. (1972). *Koutougakkou gakusyuu sidouyouryou kaisetu Kangohen* (Commentary of High School Curriculum Guidelines For Nursing) higasiyamasyobou, Kyoto (In Japanese).
- Ministry of Education, Science and Culture. (1979). *Koutougakkou gakusyuu sidouyouryou kaisetu Kangohen* (Commentary of High School Curriculum Guidelines For Nursing) higasiyamasyobou, Kyoto (In Japanese).
- Ministry of Education, Science and Culture. (1989). *Koutougakkou gakusyuu sidouyouryou kaisetu Kangohen* (Commentary of High School Curriculum Guidelines For Nursing) higasiyamasyobou, Kyoto (In Japanese).
- Ministry of Education, Culture, Sports, Science and Technology. (2002). *Koutougakkou gakusyuu sidouyouryou kaisetu Kangohen* (Commentary of High School Curriculum Guidelines For Nursing) higasiyamasyobou, Kyoto (In Japanese).
- Ministry of Education, Culture, Sports, Science and Technology. (2010). *Koutougakkou gakusyuu sidouyouryou kaisetu Kangohen* (Commentary of High School Curriculum Guidelines For Nursing) higasiyamasyobou, Kyoto (In Japanese).
- Mitui Sayo. (2004). *Keanosyakaigaku Rinsyougenbatonotaiwa* (Sociology of Care Dialogue with the Clinical Site), keisousyobou, Tokyo (In Japanese).
- Ministry of Education, Culture, Sports, Science and Technology. *Koutougakkou ni okerukangokyoiku* (Nursing education of high school), [http://www.mext.go.jp/a\\_menu/shotou/shinkou/kango/index.htm](http://www.mext.go.jp/a_menu/shotou/shinkou/kango/index.htm) Last Accessed 1 November 2016. (In Japanese).
- Nakajima Kieko, Maehara Sumiko. (1973). Research on the Actual Condition on Instructor of Nursing Course of High School in Japan, *Bulletin of the Faculty of Education, Chiba University*, Vol.2(22), pp321-333, Chiba (In Japanese).
- Tutui Mayumi. (1993). *Kea/Kearingnogainen* (The Concept of Care/Caring) *Kangokenkyu* Vol.26(1), pp2-13, Tokyo, (In Japanese).
- Yamazaki Shigeaki, Roppongi Yoshie, (2005), *Kangokenkyuuno tameno bunkengaido (dai4han)* (Literature Search Guide for Nursing Research (4th edition)), Japanese Nursing Association, Tokyo (In Japanese).

---

**Topic : Socioeconomics Relations**

A Game Theory Approach to the Bargaining Process  
between Japan and the U.S.in the Pre-War Period

Shuhei Shiozawa \*

*Keio University, 2-15-45 Mita Minatoku Tokyo 108-8345 Japan*

---

**Abstract**

We analyse the political and military bargaining between Japan and the U.S. from 1905 to 1941, using game theory concepts. We conclude that the outcome of the Washington Naval Limitation Meeting was not Nash equilibrium since Japan had an incentive to deviate. After the war in Europe began, the U.S. seemed to begin an anti-Germany war. The decision-making process in Japan during that period could be viewed as a mini-max principle. We formulate a three-period game corresponding to historical evidence. In this game, the loss of Japan is minimized when Japan declares war on the U.S. in the second period since the ratio of Japanese naval power to that of the U.S. was maximized in that period.

**Keywords**

Bargaining; Hawley=Smoot Tariff Act; mini-max strategy; Navy disarmament conference; the Anti-Japanese Sentiment Immigration Act

---

1. Introduction

We analyze the political and military bargaining between Japan and the U.S. from 1905 to 1941, using game theory concepts. The decision-making process in Japan during that period could be viewed as a mini-max principle.

The behaviour of Japan was affected by an action of the world situation and the United States in particular. We cannot evaluate the behaviour of Japan appropriately by watching only Japan. In that period, most areas of Asia and Africa were assumed a colony of the European and American Great Powers.

The United States was expanding frontier from the East Coast of the North American Continent, and the intention that stretched out a sphere of influence to the west in the Pacific was clearer after having reached the West Coast. After having annexed Hawaii in 1898, there was the intention of the entry to the China market and insisted on an open-door policy in 1899. Furthermore, I possessed the Philippines in 1901 and placed it under power. After Russo-Japanese War of 1905, the United States assumed Japan a hypothetical enemy. Therefore, it is thought that a diagram called the opposition with an American world strategy around the west Pacific and the strategy of the Japanese independence maintenance for it became clearer after it. The absolute anti-Japanese sentiment Immigration Act based on the racial discrimination was passed in 1924 and expelled a Japanese emigrant. In response to the Great Depression of 1929, the Hawley=Smoot Tariff Act, which imposes the duty more than a maximum of 800% on an import fortune is passed and will have a big influence on Japanese economy. Furthermore, a Great War outbreak in Europe of September, 1939 has a big influence on the policy of both Japan and the United States.

---

<sup>s</sup> Shuhei Shiozawa 81-3-3453-1302  
E-mail address shiozawa.shuhei@keio.jp



We consider the bargaining process between Japan and the United States while considering the difference in both political system and economic situation in such a frame. A series of movement of the two countries or the strategy divide it into some categories and can think. The first relates to economic activities and includes the Hawley=Smoot Tariff Act or an oil embargo. The second relates to naval armaments and is Washington disarmament treaty and withdrawal of Japan, navy expansion plan for it of America. The third relates to the international relations for the country except Japan and the United States, such as Japan, Germany and Italy Triple Alliance. In addition, we know that the strategic choice that Japan can take has been narrowed rapidly because a cabinet changes frequently in Japan. Furthermore, it is thought that a new cabinet played a sub game in the choice of the extremely limited strategy under the new strategy of the United States for the strategy of the predecessor because the supreme command department of army and navy was not the system which a consistent policy has stolen.

## 2. Economic relations

### 2-1. The change of the U. S. diplomatic policy to Japan after the Russo-Japanese War

The Russo-Japanese War from 1904 through 05 terminated by the conclusion of the Portsmouth treaty of September 5, 1905 by the intermediation of President American Theodore Roosevelt.

Edward Henry Harriman, who was an American railroad baron, wanted to make Japan and the United States syndicate, for the south Manchurian railroad which Japan would run by Portsmouth treaty, and he offered it. It is the suggestion of the partnership. For this suggestion, the Prime Minister Taro Katsura, Kaoru Inoue or Shibusawa Eiichi and others on behalf of the financial world agreed, too, and the memorandum of the preliminary agreement was exchanged on October 12, 1905. It may be said that the partnership with the American company of the south Manchurian railroad was extremely realistic choice for Japan which became impoverished financially militarily just after the Russo-Japanese War. In addition, it was equal with the American national interest that fell behind other Great Powers while aiming at an advance to Mainland China. However, Jutaro Komura, who compiled Portsmouth treaty as Japanese side full power and, went back to my own country, and returned to the Minister of Foreign Affairs on October 15, objected strongly for this suggestion. The grounds were things not to be able to sell Manchurian that I obtained by the blood of Japanese officers to the United States, and in a sense it was a just argument, but it was expected that Japanese Government cancel a memorandum bound together once one-sidedly on October 25. After this, the American strategy that aimed at the entry to the continent market to Japan comes to assume change, Japan a hypothetical enemy.

### 2-2 Racial discrimination policies and the anti-Japanese sentiment Immigration Act

One of the basic institutional characteristics to characterize the global community until the early 20th century includes the racial discrimination policy that has been taken openly in European and American society. These are not things of the kinds such as personal prejudice and feelings; in a public thing such as a law and a policy of one country or the judicial decision.

Japan participated in World War I that broke out in 1914 as the allied powers side by a Japan-Britain alliance, and the allied powers side increased the United States from 1917.

In a peace conference after World War I started in January, 1919, Japan planned to insert the principle of racial equality in League of Nations agreement above sentence or league agreement Article 21 to guarantee religious liberty. In contrast, Australia with "federal emigration limit law" to limit the emigrant of the coloured race objects in various form strongly, and Japan gives up the insertion of "the racial equality". And Japan suggested that "We approved principles of the fairness service for the equality of each nation and the nation" and inserted the phrase in the League of Nations agreement above sentence in the place of the meeting in the League of Nations Committee last of April 11, 1919. Though there were more agreement 11, objection 5 and agreeable countries, President Wilson which was the chairperson should decide such an important thing not decision by majority unanimously and, for this suggestion, smashed this plan.

In addition, the American Supreme Court performed the judgment "that the yellow-skinned races could not be naturalized and were a foreigner, and the naturalization right did not have" in 1922 and deprived it to the Japanese right that I was already naturalized in. This is measures by the subsequent law that must not be a modern constitutional state. Furthermore, "the absolute anti-Japanese sentiment Immigration Act" to expel a Japanese emigrant is passed in 1924. This law is the federal law whereas a previous anti-Japanese sentiment law was a state law.

### 2-3. Block economization as the correspondence to the Great Depression and autarky

When the Great Depression occur in 1929, the Hawley=Smoot Tariff Act, which imposed the duty more than 800% passed an assembly to import fortunes more than 1,000 items in the United States and the President signed it in 1930, the following day and was established.

In addition, the U.K. makes a duty that there few it between the colony in Ottawa meeting (Ottawa Agreements) in 1932, but decides that I hang a high duty for the outside the area. It is said that this did collapse and the block economization of the free trade system conclusively.

It is thought that there were such situation and "the absolute anti-Japanese sentiment Immigration Act" in one of the backgrounds of Manchurian Incident of 1931 and the Manchurian country establishment of 1932.

The disposal of "treaty of commerce and navigation" is given notice of from the United States in July, 1939. The Hawley=Smoot Tariff Act largely limited import from Japan, but the disposal of this "treaty of commerce and navigation" meant that I did not sell important resources for Japan. The U.K. and the Netherlands follow in 1941 two years later. Japan will in this way lack in raw materials necessary for modern industry such as iron, tin, aluminium, wool, the rubber conclusively. Furthermore, 80% imported the oil in those days from the United States, and, in Arab countries which were other main oil production area, Malay Peninsula, North Borneo, the British follower, Indonesia were under the control of the Netherlands.

On July 25, 1941, the United States freezes Japanese assets residing in the United States, and Japan starts stationing in a southern Buddha mark (Vietnam) on July 28, and the United States embargos oil entirely for Japan on August 1. This means that the Japanese armaments become zero virtually in 1~2 years losing storage of the oil.

## 3. Navy disarmament conference

### 3-1 Washington meeting

Based on overheat of the-based warship competition by the major country navy, during World War I and post-war period, the United States suggested the holding of the disarmament conference in Washington to each country in 1922.

As a result of meeting, a disarmament treaty was concluded, and, as for the U.K., the United States, Japan, France, the possession ratio of the capital ship including the Italian battleship, it was decided 5, 5, 3, 1.75, 1.75, to cancel the building of the capital ship again for the next ten years. In other words, the capital ship possession ratio in Japan became 60% to U.S.

In addition, it was determined to hold a meeting after having passed after treaty effect outbreak in eight years to accept the tendency of the times and technical progress.

### 3-2 London meeting

London meeting was held in 1930 eight years later by the rule of the Washington meeting. The chief end of this meeting was a limit of the quantity of possession of the war vessel except the major ship including cruiser, destroyer and submarine, and re-extension for a capital ship building interval decided in Washington meeting. As a result, the ratio of the quantity of possession of Japan to U.S. was 60% for battleships and aircraft carriers, and was 64.3% as the whole.

It was thought that the force in the sea was proportional to square of the quantity of main war vessel possession such as battleships in those days. Therefore, the naval war vessel which Japan held was 60% to U.S., and it was to U.S 36%, and that the Japanese navy force could not responsible in the national defense. If it was 70%, it became 49% and thought that the Japanese Navy could permit it, so that they insisted on 70% to U.S. strongly. It was said that Japan could maintain American 70% that was a permission standard for the navy by the then strength of a nation if the United States did not change quantity of war vessel possession. Hence the Washington Convention was not a Nash equilibrium, and it was not stable in that sense.

### 3-3. The issue of supreme command dried criminal

The person in charge of the disarmament treaty conclusion in the London meeting was Prime Minister Osachi Hamaguchi, but, as the thing which performed a dried conviction of "the supreme command" that this conclusion was prescribed by Great Japanese Imperial Constitution Article 11 and Article 12, was politicized. In other words, armaments are problems of the supreme command, and the authority to decide it in the cabinet which does not have the supreme command under Great Japanese Imperial Constitution is the claim that there is not. In the case of the decision making as the Japanese nation, I brought big influence, and, as for this "supreme command dried

criminal" problem, it followed that I often lacked in the consistency with diplomacy and military affairs afterwards.

Actually, because possession of 70% was not accepted, Japan withdrew from a disarmament conference and was going to maintain quantity of war vessel possession than 70% to U.S. However, it was feasible under the premise that the U. S. did not change a strategy, and was not possible to maintain the numerical value, when it was not so. Japan would take the wrong prediction about the United States changing the strategy here. If the United States did not change a conventional strategy, Japan should have been able to maintain quantity of war vessel possession more than 70% to U.S. However, in a sense, as a matter of course, the United States changes the strategy for Japan having changed a strategy. It is "The third Vinson plan" and "Two-Ocean Navy Act" which were established in 1940.

A time limit of the Washington Convention expires by withdrawal of Japan at the end of 1936. For "The third Vinson plan" and "Two-Ocean Navy Act", the expectation of the force ratio by the Japanese navy Naval General Staff was 75% in 1941, less than 50% in 1943 and less than 30% in 1944. Therefore, the choice is extremely limited when we think about a sub game after the disarmament conference withdrawal, and it may be said that the navy authorities recognized that a difference enlarges after 1941. But this means that navy couldn't but admit that a prediction of the Japanese Navy about the American correspondence that became the basis of the judgment to withdraw from a disarmament conference took the wrong it.

This "Two-Ocean Navy Act" established in July, 1940 was the contents which could not possibly cope by the strength of a nation of then Japan with a thing to make 35 battleships, carrier 20, warplane 25,000 by 1946.

#### 4. Relations with other countries

Triple Alliance among Germany and Italy was concluded in September, 1940 one year after the Great War outbreak in Europe of 1939. German military predominance continued in those days in Europe. However, Germany persecuted a Jew as a national policy, and it followed that I worsened the feelings of the United States nation that large number of influential Jewish nations existed including economy in many fields to Japan more.

Actually, the United States gives an export of scrap iron restrictions law for Japan in October, 1940 just after the Triple Alliance among Germany and Italy conclusion.

The U.K. which was numerical inferiority wanted to let the United States participate in the own country side somehow militarily. In such situation, President Franklin Roosevelt broadcasts virtual war intervention on a radio for all nations on December 29, 1940. Furthermore, the United States devises "the rainbow 5 plan" that is a strategic plan to Japan on March 27, 1941.

The U.K. and the Netherlands followed economic sanctions measures by the United States to Japan in July, 1941 and, including the Republic of China which was in a battle state, were called ABCD (America, Britain, China, Dutch)encircling.

On October 2, 1941, Hull notebook is taken out. This content is done with virtual final note to depend of America with a thing in defiance of a past negotiations process.

## Navy armaments ratio to U.S.

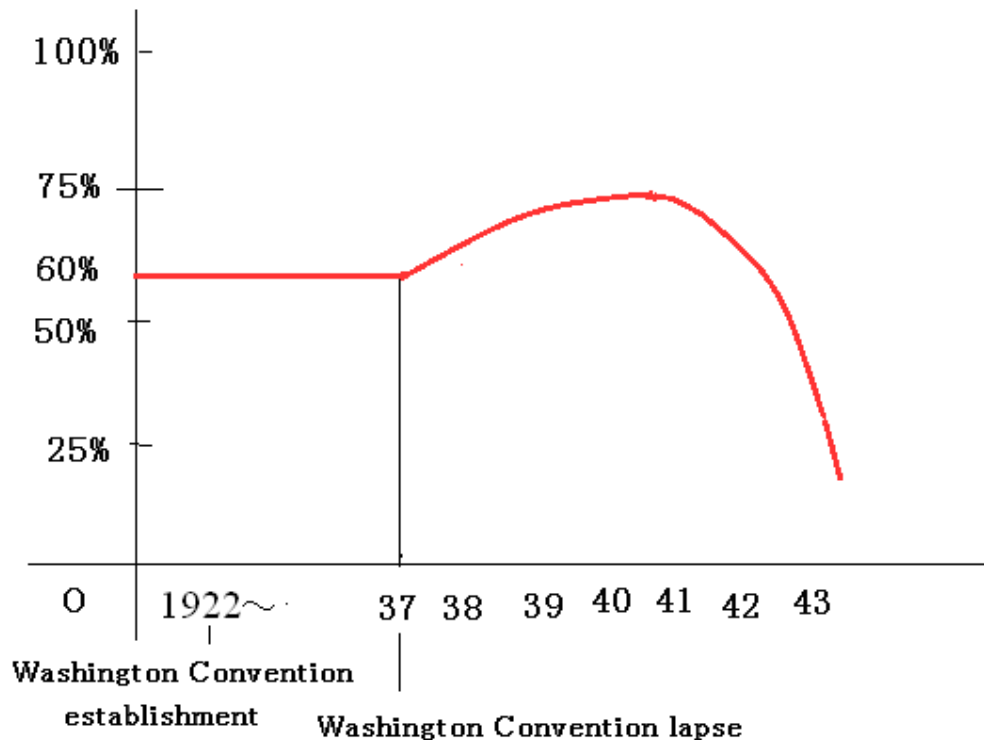

Figure 2.

### 5. The bargaining process after the Great War outbreak in Europe

#### 5-1. The situation of the United States

Because they can expect the effect of the effective demand promotion by the preparations for war reinforcement without there being the strong request from the U.K. after World War II outbreak in Europe of September, 1939, and getting rid of the Great Depression that began domestically from 1929, it is thought that President Franklin Roosevelt aimed at the outbreak of war with Germany.

For the United States which insisted on an open-door policy in 1899, it might be said that an entry to the China market was the problem that was important as Great Depression measures as the large increase of the demand for the war industry was an extremely effective policy for Great Depression conquest, and having mentioned above again for the United States troubled with the high unemployment rate while being blessed with natural resources such as oil or iron.

The President in the United States is a chief executive of army and navy having the appointive power of all cabinet ministers. He can take a continuously stability-like policy after a presidential election for four years and become able to perform consistent diplomacy and military campaign. This is the point that is different from the Japanese political system conclusively in that period. Generally, it is extremely difficult for a politician to take a policy against campaign pledge. The declaration of war from the own country is against campaign pledge of 1940 of President Roosevelt, and it is disadvantageous politically, and the feasibility is low. In addition, even the President has difficulty in participation in a war in the form in defiance of public opinion because the approval of the assembly is necessary for declaration of war, and public opinion has big influence. I turned radiobroadcast to declare virtual intervention for the war in Europe on December 29, 1940 to all nations, but there is a gulf for a reaction of the public opinion in really dispatching troops with exporting weapons and the staff for battles.

However, there was Triple Alliance among Germany and Italy signed in September, 1940, and the participation in a war to Europe is justified if declared war against by Japan. But because Germany was not to declare war against it at the same time even if Japan declared war against the United States as for Triple Alliance among Germany and Italy, it did not mean that he could

participate in Europe automatically, but war-weariness-like public opinion in the United States was big, and it was expected that he moved.

On the other hand, it was the United States with the big strength of a nation potentially, but suitable time is necessary for war preparation, and what he participate in promptly is undesirable. After having put some run-up when I take these into consideration, a battle state begins in form scored the first by Japan, and it is thought that it was the development that is the most desirable for the Roosevelt government to enter the Great War with the approval of the assembly which stood on it.

#### 5-2. The situation of Japan

Because the national economy receives a serious blow, and an emigrant to the United States was done with impossibility in the other by Hawley=Smoot Tariff Act passed just after Great Depression outbreak of 1929 as having mentioned above, a large quantity of unemployed people will occur.

The disposal of "Treaty of Commerce and Navigation" given notice of from the United States in July, 1939 just before the Great War outbreak in Europe meant that the import of indispensable important resources extremely became difficult as iron, tin, aluminium, wool, a modern nation including the rubber for Japan. Furthermore, after August, 1941, oil import from the United States which occupied 80% of the oil consumption of Japan was prohibited, and it was concerned about dwindling for the force economically.

The biggest characteristic in then Japan is that "The Supreme Command" became independent when we think about the decision-making mechanism as the nation. In other words, the supreme command which was the order right in military affairs became independent from the cabinet. Therefore it is extremely difficult to take diplomacy and military consistency and will often receive criticism with the double standard from the foreign country.

The cabinet changed frequently, too and lacked in consistency, the consistency of the policy with a diplomatic aspect. Furthermore, it was extremely difficult to keep a foreign policy and the consistency of the military campaign by independence of the supreme command which we stated above. Therefore, in each cabinet, it is thought even if they played a sub game in a certain situation given beyond own responsibility. It is a big difference with United States where it was able to have policy-like consistency toward or Germany. It may be said that this shows that it was in a far state with "the conspiracy" in Japan accused at Tokyo trial.

In addition, unlike the United States or Germany and the Soviet Union, we do not hit it in the organization system, which integrate the navy with the army and can apply. Ministry of Defense which it was the organization which stood side by side, and the army and the navy moved in an original budget and the chain of command on the personnel affairs system and strategy side, and integrated them or the organization corresponding to the Department of Defense did not exist.

Furthermore, in army and each naval, military administration and a military command isolate it. The military administration is a thing in charge of a budget and personnel affairs side, and a person in charge is the Secretary of State for War who is the member of the cabinet and a Minister of the Navy. On the other hand, the military command is a thing in charge of the use on the military affairs side, and a person in charge is the staff officer president in the army and is the Naval General Staff president in the navy. They were not able to interfere it not the thing which belonged to the cabinet mutually again.

When time passed after Washington disarmament conference withdrawal about the armaments to some extent by American the third Vinson idea and Two-Ocean Navy Act, which mentioned above, it was thought that the force difference opened so that time stood by a Japan-U.S. economic power difference after it. Japan among the seas may receive an attack tactically from anywhere, and it is extremely disadvantageous to receive the initiative from the other countries, and the declaration of war from the own country is advantageous tactically.

In addition, it is thought that there was the repulsion for having received institutional racial discrimination in the background in the global community of many civilians having supported the outbreak of war including people called an intellectual, the cultured person as well as some officers. Iwata (2015) points out that "a personal grudge" to be hard to permit an insult for oneself changed to "moral indignation" for the system itself.

According to Yoshida (1983), Osami Nagano who was the Naval General Staff president performs the following situation recognition with a statement book in September, 1941.

The armaments in the Far East of America make progress very much in late 1942, and correspondence becomes the difficult situation. The United States extremely has many good chances to be reflected on a long-term strategy from a beginning. The war end is difficult and is

expected even if Japan wins by a short-term decisive battle when I move to long war. I conclude it to be considering what I score the first from Japan, the weather of the (3) field of operations without being opened the scoring from deciding the outbreak of war judging from the fact of the (1) force immediately, the (2) United States by such recognition.

He remained in a tactical level in conclusion, and distinction of "a strategy" and "the war" was not done definitely while he did wider situation recognition in this statement book, but it may be said that these contents became the basic policy of the policy in afterward.

It is thought that the then Japanese leader particularly the navy had a strategic idea based on the mini-max principle when they took these into consideration. In other words, they assumed always the worst situation fetching a declaration of war by the United States or the action that was almost it virtually for, and that they chose a strategy (outbreak of war time) that there were the fewest losses on the premise. The grounds of the judgment are the war vessel possession ratios after the disarmament conference withdrawal, and quantity of storage of the oil increases after the oil embargo by the United States. On the other hand, Japan did not understand importance of the campaign pledge in the decision making process of America and obtains it for fear of the United States opening the scoring.

## 6. Formulation as three-stage game

### 6-1. Influence of the hours progress

Based on these facts and the situation in the rear, I consider time until about 1944 as the development form game that I divided into three stages after a Great War outbreak in Europe of September, 1939. The first stage corresponds to the period from 1939 to September, 1940, when Triple Alliance among Germany and Italy was signed. The second stage corresponds to the period from October, 1940 to 1942. The third stage corresponds to the period after 1943 when a war vessel started work by the third Vinson plan was completed. Each country has two choices, continuing negotiations without opening the scoring and opening the scoring.

The major ships possession ratio was 60% to U.S. under Washington Convention in the Operation. Japanese Naval General Staff section predicted it with 75% in late 1941, in less than 50% in 1943, and less than 30% in 1944.

It is thought that the gain is high so that a statement book of Nagano has it about the initiative influence because to score the first becomes advantageous to Japan tactically, and the political difficulty by what we score the first again in the country is unlikely to produce it than it is scored the first in which point in time in the first half.

On the other hand, it is thought that to score the first in which point in time is low in the gain because the United States has a big political difficulty to be against the campaign pledge of the President, and it is expected that the military loss when it was opened the scoring is restrictive.

### 6-2. Illustration of the payoff

During negotiations continuation, we assume payoffs of both Japan and the United States are zero, and the Japanese payoff after the outbreak of war is negative and the American payoff is positive.

For Japan, the payoff is the highest in the second stage when the force difference between Japan and the United States is minimized, and the payoff is the lowest in the third stage when a force difference opens at an increasing tempo by the third Vinson plan and Two Ocean Navy Act.

On the other hand, for the United States, the payoff is the lowest in the second stage when the force difference between Japan and the United States is minimized, and the payoff is the highest in the third stage when a force difference opens at an increasing tempo by the third Vinson plan and Two Ocean Navy Act.

From a tactical advantage, the payoff of Japan is higher when it is opening the scoring first. The payoff of the U.S. is higher when Japan opens the scoring from a political reason.

The first stage is during Japan-U.S. negotiations continuation, and the U.S. side is less likely to receive the initiative again because preparations for war are not set. The Japan side is a half-cock, too.

In the second stage, the force difference between Japan and the United States in the Pacific is minimized. Japan does not want to carry over outbreak of war decision in the third stage when a force difference spreads with time. Assuming the short-term tactical victory by Japan opening the scoring, the room for peace negotiation under conditions of the suitability is left.

In the third stage, the strategic difference spreads with time, and the damage when Japan received the initiative is serious. Storage such as the oil disappears, and the possibility of advantageous negotiations is extremely low.

Let  $U_t^{JO}$  and  $U_t^{AD}$  denote the payoff of Japan and the U.S. respectively when Japan opens the scoring in the t stage. And let  $U_t^{JD}$  and  $U_t^{AO}$  denote the payoff of Japan and the U.S. respectively when the U.S. opens the scoring in the t stage. According to the previous discussion, the payoffs of Japan seem to satisfy the following condition.

$$U_2^{JO} > U_1^{JO} > U_3^{JO} > U_2^{JD} > U_1^{JD} > U_3^{JD}$$

And the payoffs of the U.S. seem to satisfy the following condition.

$$U_3^{AD} > U_1^{AD} > U_2^{AD} > U_3^{AO} > U_1^{AO} > U_2^{AO}$$

We exemplify a payoff list to meet these conditions in Figure 2.

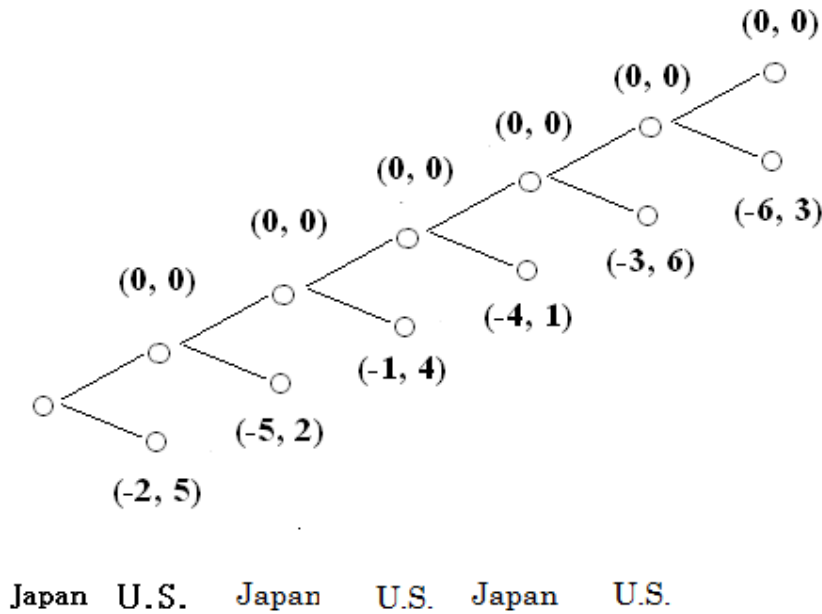

Figure 2

It is thought that it has suitable rationality to open the scoring to the second if we think that Japan faced such a sub game. But we do not consider it about the payoff when in this case Japan received a demand of the U.S. in acknowledgment of Hull note overall.

## 7. Concluding remarks

It may be said that Japan driven into economically by "absolute anti-Japanese sentiment Immigration Act" establishment of 1924 in the United States, by Hawley-Smoot Tariff Act establishment of 1930. And by denunciation of "The Treaty of commerce and navigation" in July 1939, Japan was extremely limited to the choice at the time of a Great War outbreak in Europe in September, 1939 as an industry nation in modern times.

On the other hand, in the Washington disarmament conference that prescribed the navy armaments of the major country, the quantity of main war vessel possession of Japan was 60% of the U.S. When Japan was suppressed in 60%, the Japanese Navy understood this, and it followed that I withdrew, on the contrary, to have suppressed the United States in 167% because I was not able to understand it. The situation after the Washington disarmament conference was not Nash equilibrium in this sense.

If the United States did not change a strategy after disarmament conference withdrawal,

Japanese Navy thought that Japan could maintain 70% to U.S., but, as a matter of course, the United States changed a strategy. Therefore, judging from a military aspect, it became that the Japanese choice was limited.

Japan misunderstood about the intention of the U.S. after the Great War outbreak in Europe. In addition, analysis about the authority of the assembly about the meaning of the pledge in the U.S. political system particularly the presidential election and diplomacy, military affairs was insufficient. Therefore, the payoff that Japan assumed was not necessarily the thing which reflected reality precisely. Therefore Japan mistook reactions of the U.S. at some important stages.

The choice for Japan was extremely restrictive, and, after an oil embargo by the United States, it was thought that the strength of a nation difference between Japan and the United States was enlarged at an increasing tempo with progress of the time. As for the armaments ratio in Japan to U.S., 1941 will take 75% of maximums. In such situation, it may be said that Japan took the action based on mini-max principle. It may be said that the declaration of war from Japan at the end of 1941 when Wood(2007) points it out when decided based on "the accurate calculation of the military risk" was a mini-max strategy in the sub game there if Japan thinks that the outbreak of war to U.S. is not avoided. But it may not be said that an action after the outbreak of war of Japan was based on military rationality.

#### References

- Iwata, Atsushi (2015), "Greater East Asia War to read and to solve from racial discrimination", Saitosha
- Watanabe, Shoichi (2006), "Testimony of the Hideki Tojo history", Shodensha
- Wood, James. B. (2007), "Japanese Military Strategy In The Pacific War", Rowman & Littlefield
- Yoshida Toshio (1983), "Five Ministers of the Navy", Bungeishunju



**Topic :** Macroeconomics

**A Possible Answer to Japan's Deflationary Problem as Revealed  
by the Use of a Modified Phillips Curve, and an Explanation of  
Some Seemingly Contradictory Results**

Noriko Ashiya\*

*Meikai University, 1, Akemi, Urayasu-shi, Chiba-ken 279-8550, JAPAN*

---

**Abstract**

This paper identifies the mutation of the Japanese inflation-unemployment dynamics through the use of estimation models based on a reduced, triangular Phillips curve structure, and the modified Phillips curve theory, the analysis of which tracks the economic booms before the bubble economy bursts, and continues to track the long recessionary period that follows. Our findings reveal that the productivity-driven real wage flexibility might be viewed as a key factor that helps cure deflation. As a spin-off of our theoretical examination, we also arrive at the role of price expectation in a matured economy with severe price competition in commoditized markets.

**Keywords**

Phillips curve; triangle model; deflationary problem

---

**1. Introduction**

Recently the American economist Robert J. Gordon (2013) has revived the Phillips curve relationship which has not been used fruitfully as an economic tool since the mid-70's and also after the financial crisis of 2008 (see, Figure 1). The re-emergence of the Phillips curve is supported by Watson (2014), who adopted Gordon's praxis of excluding long-term unemployment in one crucial part of his paper. In contrast, upon examining

---

\* Corresponding author. Tel.: +81-47-355-5120; fax: +81-47-350-5504.  
*E-mail address:* nashiya@meikai.ac.jp

Figure 2, the reader will notice an illustration of the crux of this paper. Why does the plotting for Japan's Phillips curve appear so stable, despite the fact that the economy tracked by this curve has moved down along the horizontal axis (unemployment) into the fog of low inflation with a high-unemployment dimension? The answer to this question might provide a remedy to the problem of deflation in Japan, and this paper is an attempt to provide empirical evidence and corresponding theoretical underpinnings to support this assertion.

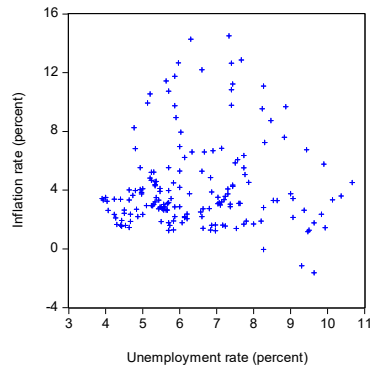

**Figure 1. Inflation versus Unemployment in the U.S.**

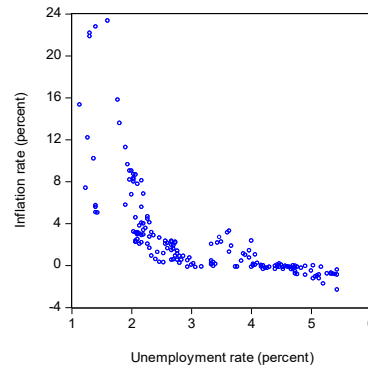

**Figure 2. Inflation versus Unemployment in Japan**

In fact, we conclude that the productivity-driven real wage flexibility might be viewed as a key factor that helps cure deflation; this result is consistent with Hamada and Kurosaka's (1986) findings on Japan's labor market, suggesting that real wage flexibility accommodates productivity changes during the period 1971-75, and up to 1983. Our singular evidence comes from the sample of the first-half, between 1972:Q1 and 1991:Q4, and its insights into the balance between the real wage growth and productivity trend change is consistent with Japan's labor market at that time. More precisely, our findings suggest that upward-drift in the real wage rate, which moves concurrently with productivity growth, is the key factor that unifies the movement of the inflation-unemployment combination in the high-inflation with low-unemployment dimension (pre-1992) and the low-inflation with high-unemployment dimension (after-1992) down the decades of the timeline, to arrive at the clear delineation of the Phillips curve.

Japan's economy has commonly been considered to have gone through the breakpoint of its growth around the year 1992 (concerning this view, see, e.g. Krugman, 1998), and this fact is also supported by the flattened Phillips curve (see, Harada and Okamoto, 2001, which pointed out such a mutation of the curve first); whereas, our findings suggests that the mutation of the economy behind the curve can be explained by one representative factor, the productivity. Given the ideally linked combinations of unemployment and inflation distribution for the previous decades, we could find a

remedy to move onto the upper-left/positive-inflation area; which perhaps indicates the deflationary cure.

Moreover, we carry out estimates of Japan's Phillips curve through the simplest way. The estimation model is based on a reduced, triangular Phillips curve structure with a constant NAIRU (as per Gordon, 2013). The treatment of the productivity variable we have followed is based on Dew-Becker and Gordon (2005), which we used to calculate the inflationary pressure of varying productivity trend growth. To arrive at the possible answer to Japan's deflationary problems we simply used the total unemployment rate, and did not exclude long-term unemployment from the data. The result may be seen in Figure 2, in the stable relationship of headline inflation and ordinary unemployment in Japan. As a spin-off of our theoretical examination, we also arrive at the role of price expectation in a matured economy with severe price competition in commoditized markets.

Crucially, our estimates of Japan's Phillips curve show evidence that is contradictory to the price theory that the Phillips curve represents, as the sign of the regression coefficient of the productivity variable is estimated as positive for the first-half period, which, by the ordinary theory, is shown to be negative. To obtain supporting evidence that may solve these contradictions, the productivity effect is postulated to increase the real wage rates. We argue in this section that if there is no evidence for this hypothesis, then, there is no reason to believe that the actual Phillips curve moves upwards in the first-half period. Given this shift, if sufficient enough to cancel out the negative productivity effect on the price inflation, we can arrive at the positive regression coefficient of the ordinary Phillips curve model. Given those findings, we formulate a modified Phillips curve, which includes a real-wage-setting function reflecting the additional effects of productivity growth, and give explanations for those contradictions by examining the theoretical underpinnings that may coincide with the evidence. Throughout the paper, we go through the estimates and calculations using both Japanese and U.S. data, to highlight the evidence-based characteristics that are unique to Japan.

## **2. The Simplest Model for Japan's Phillips Curve**

The simplest way of arriving at PC estimation is to adopt the constant NAIRU setting as specified below (Model 1). This makes it possible to provide the first approach

to Japan's price dynamics and corresponding economic state—which makes up the discarded advantage of an ideal model setting that allow the NAIRU to vary over time (e.g., Richardson, et al., 2000). To estimate this model, we adopt the method of Ordinary Least Squares; we could calculate the NAIRU,  $U_t^N$ , as  $\alpha = -\gamma U_t^N$  holds in Equation (1) below.

***Model 1 (Phillips curve equation with constant NAIRU setting).***

$$\pi_t = \alpha + \sum_{i=1}^4 \beta_i \pi_{t-i} + \gamma U_t + \sum_{i=0}^3 \delta_1 \text{energy}_{t-i} + \delta_2 \text{prod}_t + \varepsilon_t \quad (1)$$

where  $\pi_t$  denotes the level of price inflation,  $U_t$  denotes the unemployment rate,  $\text{energy}_t$  denotes energy prices,  $\text{prod}_t$  denotes productivity, and  $\varepsilon_t$  is an error. The lag length and polynomials, and the inclusion and exclusion of the supply shock variables are the reasoning from Gordon (2013).

The next model is the real wage setting function. In this model, we set real wages, instead of prices, as the dependent variable. To maintain the Phillips curve relationship between inflation (in this model, the real wage inflation) and unemployment, we set the unemployment as one of two independent variables. Other independent variables we set are productivity and energy prices; this setting is in line with our study focus, placed in the previous section based on our estimation results.

***Model 2 (Quasi-Phillips curve that explains real wage setting behavior).***

$$\Delta \omega_t = \alpha + \gamma U_t + \sum_{i=0}^3 \delta_1 \text{energy}_{t-i} + \delta_2 \text{prod}_t + \varepsilon_t \quad (2)$$

where  $\Delta \omega_t$  denotes the real wage inflation. To estimate this model, we adopt the method of Ordinary Least Squares as well.

### **3. Data**

This paper will focus on the total indicator of consumer price inflation. For Japan, CPI for all consumers, all items less fresh food basis; which is the targeted index (from 2013:Q2) or a guide index (up to 2013:Q1) for the inflationary trend that the Bank of Japan has been tracking. For the U.S., we use the most explanatory variable for comparison as CPI for all urban consumers, although this includes the fresh food prices, and does not survey all the areas in the U.S. economy.

To emphasize the firm's price- and wage-setting behavior that the Phillips curve represents, we do not subtract the inflationary effects of the sales tax hike from the series of both CPIs. The economic logic behind the Phillips curve supports simply to use the CPIs as released, as the firm, in theory, rationally includes the upward pressure of the sales tax hikes on wages and prices.

Productivity is another focus. As per Gordon (2013), this paper introduces the Dew-Becker and Gordon (2005) type productivity variable: the productivity trend growth acceleration variable equal to Hodrick-Prescott's filtered version of the productivity growth trend (using 6400 as the smoothness parameter) compared to that trend eight quarters earlier. For the U.S., we use a series data, NFPB output per hour from U.S. Bureau of labor statistics. Whereas for Japan, we use quarterly GDP and the number of employees to calculate this; due to data availability, we use the number for the office that holds over 30 workers from Monthly labor survey.

We just use the total unemployment; the reason is stated in Section 1. We use the labor statistics for Japan, and the current employment statistics for the U.S. Energy and real wages are extracted from the OECD data base. We also use the OECD data base, both for Japan and the U.S., to find out the series of the average hourly wage index, which we enter into the real wage setting function as specified in equation (2).

## 4. Results

Estimates of the Phillips curve equation are reported in Table 1, which displays two remarkable contrasts.

**Table 1. Estimate of the Phillips Curve Equation (Constant NAIRU Setting), Model 1, 1972:Q1-2014:Q4**

Variable	Lags	1972:Q1-1991:Q4		1992:Q1-2014:Q4	
		Japan	U.S.	Japan	U.S.
Constant		3.036 (2.1) **	2.775 (3.4) ***	0.690 (1.9) *	1.958 (2.8) ***
Lagged Dependent Variable	1-4	0.848 (14.2) ***	0.798 (19.5) ***	0.808 (12.8) ***	0.566 (4.7) ***
Unemployment Rate	0	-1.151 (2.4) **	-0.163 (2.6) **	-0.161 (2.4) **	-0.109 (2.2) **
Productivity Trend Change	0	3.014 (0.5)	-23.752 (1.8) *	-0.575 (0.1)	-11.862 (2.0) *
Energy Effect	0-3	0.014 (0.8)	21.740 (4.4) ***	0.031 (2.6) **	25.091 (4.6) ***
Adjusted R-squared		0.97	0.97	0.97	0.97
S.E. of regression		0.96	0.53	0.96	0.53
Sum squared resid		63.22	19.33	63.22	19.33

### Notes

Estimated by Least Squares, HAC standard errors & covariance (Bartlett kernel, Newey-West fixed bandwidth = 4.0000). t-statistics in parentheses. \* indicates coefficient or sum of coefficient is statistically significant at the 10 percent level, \*\* indicates significance at the 5 percent level, \*\*\* indicates significance at the 1 percent level. The coefficients of Lagged Dependent Variable (CPI inflation) and Energy Effects (energy inflation) indicate the total/long-term effects of the four lags for each variable. Gordon's (2013) productivity variable, found to fit well at the 10 percent level to the U.S. Phillips curve.

One is the productivity effects that arise in the first and the second-half periods; the other is the same effects that arise in Japan and the U.S. Crucially, the third column reports the estimates for Japan in the period between 1971:Q1 and 1991:Q4, with the positive regression coefficient of the productivity variable (3.014)—which, although weakly so, is contradictory to the price theory that the Phillips curve represents. Further, in the succeeding period between 1992:Q1 and 2014:Q4, the same sign of the productivity variable, on the fifth column, is reported as negative (-0.575)—which is diverted from a positive to a negative, revealing the mutation of the macroeconomic relationship behind the curve.

Secondly, see Table 2. A further step was taken to arrive at a real wage-setting function by constructing the estimation equation as a Quasi-Phillips curve with OECD data on real wages (average hourly wages index), and unemployment rates and productivity we have used.

**Table 2. Estimate of Real Wage Setting Equation (Quasi-Phillips Curve), Model 2, 1972:Q1-2014:Q4**

Variable	1972:Q1-1991:Q4			1992:Q1-2014:Q4		
		Japan	U.S.		Japan	U.S.
Constant		0.047 (4.1) ***	0.013 (0.2)		0.018 (3.0) ***	0.013 (4.8) ***
Unemployment Rate	0	-0.021 (5.9) ***	0.000 (0.4)		-0.004 (3.6) ***	-0.001 (3.7) ***
Productivity Trend Change	0	0.239 (3.3) ***	0.017 (0.9)		-0.105 (1.4)	-0.001 (0.0)
Energy Effect	0-3	0.000 (1.7)	0.000 (6.7) **		0.000 (1.4)	0.000 (0.1)
Adjusted R-squared		0.43	0.44		0.16	0.38
S.E. of regression		0.02	0.39		0.01	0.00
Sum squared resid		0.02	0.01		0.01	0.00

*Notes*

Estimated by Least Squares, HAC standard errors & covariance (Bartlett kernel, Newey-West fixed bandwidth = 4.0000). t-statistics in parentheses. \* indicates coefficient or sum of coefficient is statistically significant at the 10 percent level, \*\* indicates significance at the 5 percent level, \*\*\* indicates significance at the 1 percent level. The results represent the additional productivity effects on the process of the real wage setting behavior of the firm. The dependent variable is the rate of change in the average hourly earnings index (MEI) extracted from the OECD data base.

The key proposition that we seek to test is that, in the upper-left dimension of Figure 2—which corresponds to the period between 1972:Q1 and 1991:Q4, and the plotting of data with high-inflation/low-unemployment combinations—the rate of change of real wage rates does depend on productivity factors, with some negative relationship with the unemployment rate. The third column reports evidence of significant productivity in the period between 1972:Q1 and 1991:Q4, beginning with the positive, dramatic growth of the early 70's, through the brief fading of the economy due to the oil crises of 1973 and 1979, the yen-strengthening/dollar appreciating Plaza Accord of 1985, and the eventual positive growth which resulted in the “bubble” economy, followed by a long stasis in growth. The third column also reports the significance of the unemployment variable, estimated as negative, showing a quasi-Phillips relationship between real wages and unemployment. In the succeeding period between 1992:Q1 and

2014:Q4, the sign of the productivity coefficient is reported as negative (-0.105)—which is diverted from a positive to a negative, although weakly so (see, the fifth column).

Then, we simply raise the question: why are such insignificant findings as well so important and focused? Despite some unsatisfactory statistics ( $p$ -value), our primary focus is placed on the change in the sign of the regression coefficient of the productivity variable. And, in this paper, even the findings that are contradictory to the ordinary theory have not been discarded. The answer is that we take those findings as a reflection of the surface, and not the mutation, of the Japanese economy. Therefore, a further step in the remainder of this paper will be devoted to the exploration of those estimates, seemingly contradicting the price theory that the Phillips curve represents.

## 5. Theoretical Underpinnings for Contradictory Results

What is specific to our theoretical reasoning is that, we take the Dew-Becker and Gordon type productivity  $G_t$  as an approximate of the marginal product of labor, MPL (see, the corresponding study by Akerlof et al., 1996, who adopt the ordinary definition of the same variable as labor productivity, to explain the U.S. evidence—which does not generate a positive, and therefore, contradictory, productivity coefficient in the context of constant returns).

Originally, this new definition of the productivity variable was introduced in Gordon's (2013) study to improve the tracking of the effects of the productivity growth; whereas, we use the same variable to arrive at the simplest understanding of Japan's Phillips curve. By replacing the MPL with the new productivity variable  $G_t$ , we can easily transform the theoretical model. Further, by including the  $\alpha$ -governed shifts of the real wages setting function in nonlinear form ( $G_t^\alpha/U_t$ ), we can formulate the modified Phillips curve with empirical support.

Generally, a Phillips curve can be derived from the actions of the representative firm. So, the first equation we will consider is the demand for labor by the profit-maximizing competitive firms—which corresponds to the first postulate of the Classical theory as:

$$W_t = p_t f'(n_t) \tag{3}$$

where  $W_t$  denotes the money wage rate,  $p_t$  denotes the price of the firm's output, and  $n_t$  denotes the labor unit. The term  $f'(n_t)$  denotes the derivative of the production function  $f(n_t)$ , or the marginal product of labor. Then, with the use of price expectation, we transform equation (3) into the price setting equation as:

$$p_t = p_t^e \omega_t / G_t \quad (4)$$

where  $p_t^e$  denotes the expected price level,  $\omega_t$  denotes the real wage rate. We have replaced  $f'(n_t)$  in equation (3), with  $G_t$ , the Dew-Becker and Gordon type productivity to obtain equation (4).

Then, we proceed to the firm behavior in monopolistically competitive market. The simplest way is to assume the unit elastic demand for a firm's output—which is dependent on both the price of the firm's output and the average price of in the economy. By introducing the mark-up term  $m$ , which is defined as  $m = 1 + \mu$  using  $\mu$ , the mark-up rate, we can extend equation (4) as:

$$p_t = m p_t^e \omega_t / G_t \quad (5)$$

where,  $m$  reflects the elasticity of demand,  $\beta$ , as we generally arrive at  $m = \beta / (\beta - 1)$ .

The competitive firm has  $m = 1$ , and the firm with some market power has the mark-up larger than 1 or  $m = \beta / (\beta - 1) > 1$  holds. With the setting of the unit elastic demand, we could treat  $m$  as given and constant, to highlight the suppliers' behavior to arrive at the simplest formula of the Phillips curve equation. The above formula is the ordinary specification, except that we replace the marginal product of labor with the new productivity variable  $G_t$ —but, this point becomes crucial in the explanation of our seemingly contradictory results.

So that we derive the modified Philips curve, we will include the real wage setting function, specified above as  $\omega_t = (G_t^\alpha / U_t) E_t$ , in equation (5) as:

$$p_t = m p_t^e (G_t^\alpha / U_t) E_t / G_t \quad (6)$$



Then, the modified Phillips curve, or the inflation-unemployment dynamics that our findings support, is obtained in two steps. Firstly, replacing  $p_t$  (the price of the firm's output) with  $P_t$  (the average price in the economy) in equation (6), and secondly, taking the natural log of each side of this transformed equation, and then subtracting  $\log p_{t-1}$  from both sides as:

$$\Delta P_t = \log m + \Delta P_t^e - \log U_t + (\alpha - 1)\log G_t + \log E_t \quad (7)$$

where  $P_t^e = P_{t-1}$  is assumed. Equation (7) suggests that if  $\alpha > 1$  holds, then the productivity effects from the variable  $G_t$  will become positive. And, this case corresponds to the economic state with a larger  $\alpha$  where, by our setting, the economic boom may exist.

Also, equation (7) suggests the important role of price expectation. In a matured economy with severe price competition in commoditized markets, it is reasonable to assume  $m = 1$ . Consequently, the term  $\log m$  becomes zero, having no pressure on the resulting price inflation. We have already considered the role of  $G_t$ , the new productivity notion, to have upward pressure on the price inflation. Then, the variable remains is  $P_t^e$ , which can be created through the economic policy, even in the matured economy.

## 6. Conclusion

Through the use of estimation models based on a reduced, triangular Phillips curve structure, and the modified Phillips curve theory, this paper identified the mutation of the Japanese economy, the analysis of which tracks the economic booms of the 1970's and 1980's and continues to track the long recessionary period that follows. Our findings reveal that those inflation-unemployment dynamics can be explained by the productivity variable—whether or not, and to what extent, the productivity accelerates the real wages. We could reasonably expect such productivity-driven real wage flexibility in the booming economy. Whereas, it gets more difficult in a matured economy with severe price competition in commoditized markets; consequently, the role of economic policy that externally affects the price expectation is becoming larger. Our seemingly contradictory results are not at all contradictions—the positive productivity coefficient is shown to be an outcome of the upward-shift of the real wage setting function, with empirical support.

We conclude that this shift helps cure deflation, with additional drifts that the policy creates. But, the shift factor—which, in the Japanese case, has appeared in the sign

of the estimated coefficient of the productivity variable—must be country specific, that is, different from country to country. In our analysis, the corresponding estimates of the U.S. Phillips curve become negative, consistent with the price theory that the Phillips curve represents.

Even with the setting of diminishing technology, our model could generate the cyclical movement of the real wages. But, our device to set a productivity-related real wage accelerator, is put externally. Furthermore, if we consider the Okun's coefficient, its level generally exceeds one as is accepted as fact; this is consistent with increasing returns, and would not be supported by the conventional setting with diminishing returns. Thus, a remaining issue is to elucidate those contradictions between commonly held economic law and conventional theoretical issues. Some of the source could be expected to be obtained from the calculation of the Okun coefficient and its resulting volatility; furthermore, this calculation extends the present analysis in to a more general setting of an AD-AS framework.

### **Acknowledgements**

I am very grateful to Professor Koichi Hamada for the valuable comments on the insights of my original report, and Professor Yutaka Harada for his over-all guidance in this research and his insightful comments and correspondence. I am also very grateful to Professor Kenji Miyazaki for his generous help in furthering the range and depth of my analysis.

### **References**

- Akerlof, G. A., Dickens, W. T. and Perry, G. L. (1996). The Macroeconomics of low inflation. *Brookings Papers on Economic Activity*, Vol.1, pp.1-59.
- Dew-Becker, I. and Gordon, R. J. (2005). Where did the productivity growth go? Inflation dynamics and the distribution of income. *Brookings Papers on Economic Activity*, Vol.2, pp.67-127.
- Richardson, P., Boobe, L., Giorno, C., Meacci, M., Rae, D. and Turner, D. (2000). The concept, policy use and measurement of structural unemployment: estimating a time varying NAIRU across 21 countries. OECD Economics Department Working Papers, No.250, pp.1-75.
- Gordon, R. J. (2013). The Phillips curve is alive and well: inflation and the NAIRU during the slow recovery. *NBER Working Paper*, No.19390, pp.1-54.
- Hamada, K. and Kurosaka, Y. (1986). Trends in unemployment, wages and productivity: the case of Japan. *Economica*, Vol.53, pp.S275-96.
- Harada, Y. and Okamoto, S. (2001). Nihonkeizai Teitai no Genin – Suihei na Phillips Curve no Kyoufu (in Japanese). *Toyo Keizai*, Vol.5/19, pp.72-75.
- Krugman, P. R. (1998). It's baaack: Japan's slump and the return of the liquidity trap. *Brookings Papers on Economic Activity*, Vol.2, pp.137-87.
- Nishizaki, F. (1997). The NAIRU in Japan: measurement and its implications, OECD Working Paper, No.173, pp.1-18.
- Watson, M. W. (2014). Inflation persistence, the NAIRU, and the great recession. *American Economic Review*, Vol. 104, No.5, pp.31-36.



The 7th Indonesia Japan  
Joint Scientific Symposium  
(IJJSS 2016)  
Chiba, 20-24 November 2016

---

Topic : Social Sciences and Sustainabilities

## **ARMY SUPPORT PROGRAM THROUGH SMART HOUSE IN POVERTY REDUCTION FRAMEWORK BASED ON SDGS**

Tri Endangsih, S.T, M.Ars<sup>a</sup> and Jeanie Annissa, S.IP, M.Si<sup>b</sup>

<sup>a</sup> Budi Luhur University ,Highway Ciledug, North Petukangan, South Jakarta 12260

<sup>b</sup> Budi Luhur University, Highway Ciledug, North Petukangan, South Jakarta 12260

### **Abstract**

This study discusses the smart house program organized by the army in support of improving the quality of education related non-formal education in the Cilodong area, West Java as reducing poverty by SDGs framework points 4 related to the quality of education. This study used a qualitative descriptive analytical methodology with the technique of primary and secondary data collection. Primary data through interview techniques to smart house Cilodong which is an observation area of research, while secondary data using the study of literature related to the research data of books, journals, and even the necessary documents. This study uses the concept of sustainable development goals within the framework of sustainable development and understanding of the smart house. Based on the results of the study it can be concluded that the Army has been providing support in poverty reduction related to improving the quality of education within the framework of SDGs through the establishment of a smart house program (RUMPIN) who teaches non-formal education for all ages. Non-formal education given in RUMPIN program in Cilodong, West Java. Programs provided include education (1) Library (2) the center of creation, (3) the center of the game (4) audio-visual centers, and (5) Laboratory of computer. As such, this program is expected to provide additional knowledge to people of all ages and levels of social stratification and increases the standard of living.

**Keywords : Smart House, Sustainable Development, Quality of Education**

### **A. Background**

The quality of human resources is a key development needs of the country. These needs must be supported by progress in the field of education that many changes and developments in science and technology, especially in the era of globalization. Therefore, countries in the world focus on education as one area which is becoming an important target for poverty reduction.

---

<sup>a</sup> Lecturer of Architecture Technique Faculty, Budi Luhur University, Jakarta, Indonesia, Telephone : +6221 5853753, Fax : +6221 7371164, [endangsihtri@yahoo.com](mailto:endangsihtri@yahoo.com)

<sup>b</sup> Lecture of International Relations, Social and Politics Faculty, Budi Luhur University, Jakarta, Indonesia, Telephone : +6221 5853753, Fax : +6221 7371164, [jeanieannissa@gmail.com](mailto:jeanieannissa@gmail.com)

Based on the UN agreement made with 189 countries focusing repairs poverty reduction through the Millennium Development Goals (MDGs) conducted from 2000 to 2015 that focused on eight target development by putting the improvement of education in the third point, which then continued in the program Sustainable Development Goals (SDGs), which is a sustainable development program conducted from 2015 through 2030. In the SDGs targets, improvement of education placed on the fourth point of the 17 goals were developed.

Based on these explanations, then Indonesia as one of the countries that joined the agreement need to implement a series of programs to achieve the development goals. One is education. Getting a quality education is the foundation for improving community life and sustainable development. Great progress has been made towards improving access to education at all levels and increasing participation rates in school without gender classified. Basic literacy skills have improved tremendously, but the effort is more daring needed to make a bigger step in achieving the goal of universal education. Development targets in the field of education can be classified into formal education and non-formal. In formal education emphasizes the eradication of illiteracy and the prowess counting. While in Non-formal education is substantially aimed at improving the ability of the community, especially youth groups to produce good quality of technical and vocational skills to achieve decent work that foster economic twisted so as to achieve the target of sustainable development.

Hence of that, the formation of smart house Solutions (RUMPIN) into a government support in creating quality education. RUMPIN is the big idea of the First Lady Mrs. Ani Yudhoyono of Indonesia which was formed as part of efforts to achieve the life of the nation. In accordance with the Decree of the Minister of Education and Culture No. 81 in 2013, smart house included in the category of Non-Formal Education Unit kind. In line with the government's efforts in the nation as well as to reduce poverty, smart houses presence is meant to embody the knowledge society to the formation of a prosperous and civilized society. Smart house was set to reach the unreached by the touch of progress, especially in the field of education. Through the smart house expected the people need to learn in order to create community learning (learning community) that are also expected to have an impact on the welfare of society and the nation.

Smart houses as community learning centers are designed with the needs of local communities. RUMPIN that have been built throughout Indonesia until 2015 amounted to 337 with the details of the financing of ministry of education (Kemendikbud) in 79 locations and from other sources 258 locations. One of them is the Smart House Chakras Scholar - one that is in the area of Kostrad housing headquarters Cilodong Depok is one concrete manifestation of the idea of the first lady Ani Yudhoyono, who intercepted concern by Commander of KOSTRAD (Pangksotrad) and mother Nur Alam George Toisutta will need to increase the quality of education for children children who were in the area and surrounding Cilodong that creates a younger generation of smart and qualified as the development of science and technology is so globalized. With invites students around Cilodong or Depok in general, a smart house be one alternative for the growing interest in learning, practicing and playing in order to afford sharing in the learning process in their respective schools. This educational model and reflects the oneness of the Armed Forces with the people, in where the presence of the nation's children in military discipline environment can absorb a range of values that are beneficial to the nation's future.

Therefore, both the program and the activities carried out should be based on community needs and potential of locally owned. Thus, we choose a case study in this research RUMPIN Chakra Wise 1 which was first built in Indonesia, based on this, if the needs of society and utilize local potential, the expected presence of smart house can be used as a cog for the advancement of society and development of the economy of an area. Given the smart house is one form of public education, the management of the smart house is conducted in accordance with the needs of the people, but still consider the rules or instructions that have been made by the government as a

form of accountability of the smart house. Smart houses as a means of education and community empowerment can accommodate a variety of educational programs ranging from early childhood services, adolescents, adults and seniors with a fun learning approach (joyfull learning), means (meaningfull learning) and integrated (integrated learning). With the advent of smart house is expected to awaken people who are intelligent, innovative, creative and independent. As the nation's assets must be maintained continuity smart house necessitating their continuous development by the government.

## **B. Research Objectives**

Program Sustainable Development Goals (SDGs) covers 17 targets related to sustainable development which contains the eradication of poverty; the eradication of hunger; good health; quality education; gender equality; water and sanitation; clean and affordable energy; decent work and economic growth; industry, innovation and infrastructure; reduction of the gap; sustainable cities and communities; responsible consumption; climate change action; underwater life; terrestrial life; peace and justice; a partnership in order to achieve the goal.

Based seventeen development objectives, this study focused on four targets on the provision of quality education. Indonesia as one of the countries that are also committed to the sustainable development goals to reduce poverty because of the high illiteracy rate and then through the performance of the Army (Army of Indonesian National) made program smart house which aims to provide educational services to the public that the problems of life do not receive an education or never attend primary school but drop out (DO) and do not have the basic skills of reading, writing, arithmetic. Education development issues was lack of public understanding of the importance of education for the further development of society. Most people do not understand that education is good and true, especially in remote areas or rural areas, resulting in the diversity of educational issues. Smart houses as community learning centers are designed with the needs of local communities. Therefore, both the program and the activities carried out should be based on community needs and potential of locally owned.

Look to the attention of people's needs and take advantage of the local potential is expected existence smart house can be used as a cog for the advancement of society and economic development of a region. Given the smart house is one form of public education, the management of smart house implemented in accordance with the needs of society but still consider the rules or instructions that have been made by the government as a form of accountability of the smart house.

Smart houses as a means of education and community empowerment can accommodate a variety of educational programs ranging from early childhood services, adolescents, adults and seniors with a fun learning approach (joyfull learning), means (meaningfull learning) and integrated (integrated learning). With the advent of Smart House is expected to awaken people who are intelligent, innovative, creative and independent. As the nation's assets must be maintained continuity smart house necessitating their continuous development by the government. The literacy program requires a special service in meeting their needs as a result of changes to increase the standard of living, science and technology, including the availability of human resources in order to achieve the life of the nation, which among other things is characterized by the increasing quality of life.

Targeting the public education more widely not only related to basic education for the poor, illiterate, drop out from formal education, and other marginalized groups, but continues to grow in line with developments in science and technology and the development of work field and changes in society, particularly in relation to the culture of society itself. Based on the extent of the purpose, activities for the community education program should be continue to expanded according to the needs and conditions of the development of society. The emergence of the concept

(learning community) want to learn public and lifelong learning (lifelong learning) as the main concept encourages individuals, institutions, associations, educational community care, or other business entities to participate in developing a new way of thinking in responding to the challenges of the new needs of the community about education and learning.

### **C. Research Question**

Based on the explanations that have been outlined, the research questions focused as follows: "how the support of the Army towards improving the quality of education through Smart House can be part solutive as the country's efforts in poverty reduction in the field of education based on SDGs framework 2015-2030?"

### **D. Methode of Research**

This study used a qualitative approach. Qualitative procedures have a more diverse approach in academic research rather than quantitative methods. Qualitative studies also have philosophical assumptions, strategies, research and collection methods of analysis, and interpretation of diverse data. Although the process is the same, the procedures continue to rely on qualitative data in the form of text and image, have unique steps in the data analysis, and strategies-strategies derived from different studies.

Therefore, in a qualitative study authors are required to be able to process data into an in-depth description and analysis of the data. In the process of data collection will be greatly influenced by the interpretation of the data and documents related to the topics covered. While the analysis process will be greatly influenced by the authors' interpretations of the data.

This type of research is descriptive analysis means is data obtained through analysis using the concepts that have been described. Data acquisition techniques based on primary and secondary processes, so in this study used a descriptive and analytical processes. Sources of primary data (primary data) is data obtained directly by research through in-depth interviews, direct observation involving researchers directly.

In this study, the selection of informants using purposive sampling technique. Purposive sampling based on specific goals with the requirements that must be met (Arikunto : 2010)<sup>c</sup>. While secondary data obtained from the activities will be described in the narrative literature in the earlier parts of the report. This description is done to provide the knowledge that support the army in sustainable development programs in line with the government's agenda to alleviate poverty based framework SDGs 4 points related to improving the quality of education through the construction of smart house in the area Cilodong providing education non-academic for the local population without any age limit and social levels aimed at improving professional skills and foster economic stretching to improve social welfare.

### **E. Theoretical Framework**

Sustainable development is a theoretical framework that evolved in 1972 and 1992 through a series of international conferences under the United Nations that was held in Stockholm that addresses sustainability on a global scale. As a concept, sustainable development as development that implies "paying attention" and "consider" environmental dimension. In writing Abdurrahman explained also that Sundari Rangkuti confirms that the Stockholm conference to discuss environmental problems and ways to resolve in order to take into account the carrying capacity of implementing environmental (eco-Development). In addition the report of the Brundtland Commission also produced a concept of sustainable development is defined as development that meets the development in the present without eliminating the ability of future

---

<sup>c</sup> Arikunto Suharsimi and Suhardjono, Supardi. 2010. Classroom action research. Jakarta: PT Bumi Aksara.

generations to meet their needs in the present, so that they can be assured of human sustainability in the future. Various development issues related to sustainable development in areas such as global warming, which resulted greedy economy that exploits the environment on a large scale with the purpose of utilization of resources to produce economic benefits alone can lead to social conflict.<sup>d</sup> Therefore, to provide the application to the understanding of sustainable development must involve the development in the field of quality education.

Education Field is one of the main priorities in the national development agenda. Development of education is very important because a significant role in reaching progress in many areas of life such as; social, economic, political, cultural and even technology. Therefore, the government is obligated to fulfill the rights of every citizen in obtaining educational services in order to improve the quality of life of the Indonesian people as mandated by the 1945 Constitution, which obliges the government is responsible for educating the nation and create prosperity.

Therefore, through to Law number 20 of 2003 on National Education System, Article 5, paragraph (1) states that "Every citizen shall have the same right to obtain quality education", and article 11, paragraph (1) states "The Government and regional governments are required to provide services and facilities, and ensure the quality education for every citizen without discrimination". Under the law, then one of the government's responsibility to eradicate ignorance and poverty is to build smart home (RUMPIN) as a place for people to get non-formal education, particularly related to membership, so as to improve the standard and well-being living with expertise or skills to improve living income.

In addition, this paper also uses the theory of poverty by Sumodiningrat (1998) who is describes poverty has several causes, such as poverty natural, Cultural poverty and structural poverty.<sup>e</sup> Poverty showing that the process of poverty arise from the attitudes of individuals and society itself that tends not productive or consumptive and social structure of policymakers is exactly what causes poverty. Poverty in the community caused by various factors complex and closely interrelated with one another. The condition is often described as a pattern of vicious circle that is very difficult to solve. The pattern continues over time and even tends to result in a progressively worse. Low levels of quality of life due to lack of basic facilities, poor quality of human resources, work ethic weak and difficult to grow, limited ability to find adequate employment, low ability to save, the difficulty of access to sources of capital, are some of the problems faced by the poor and left behind. Therefore, the poor need to be empowered to take and the conditions of poverty and underdevelopment, This can be done through smart home program with program craft center that has been carried out by social workers or facilitators.

Therefore, in tackling poverty requires a change in the habitual patterns of society that has not been conducive to a more insightful able to develop skills and his ability in accordance with the guidance and direction, as well as changing the guidance of structural laws that apply in the case of formulations and implementation is more real and directed to the purpose. One way is to create equitable access to education services for all the people and equality in terms of acquiring it in developing Human Resources (HR) and the Improvement of Human Development Index (HDI).

---

<sup>d</sup> Wahyu Surakusumah in "Linkage studies of Education for Sustainable Development (Education for Sustainable Development) Education Technology Association (Basic Technology Education) "which can be downloaded in the website [http://file.upi.edu/Directory/FPMIPA/Education\\_Programs\\_biologi/197212031999031WAHYU\\_SURAKUSUMAH/Assessment\\_of\\_Education\\_for\\_Sustainable\\_Development.pdf](http://file.upi.edu/Directory/FPMIPA/Education_Programs_biologi/197212031999031WAHYU_SURAKUSUMAH/Assessment_of_Education_for_Sustainable_Development.pdf) linkages. accessed on June 15, 2016.

<sup>e</sup> Maimun Sholeh, the roots of poverty and dependency in developing countries in structuralist perspective dependensia described in the site [file:///C:/Users/usee/Downloads/Akar%20Poverty%20dan%20Depedency%20di%20Coutries%20flourish%20in%20Perspective%20structuralist%20dependencies%20\(1\).pdf](file:///C:/Users/usee/Downloads/Akar%20Poverty%20dan%20Depedency%20di%20Coutries%20flourish%20in%20Perspective%20structuralist%20dependencies%20(1).pdf). accessed on June 14, 2016 o'clock 12.34

## F. Discussion

Nowadays, the world has faced various challenges associated with the development of various fields of non-conventional issues such as the environment, hunger, gender, sanitation, climate change, including education. Through SDGs, the world community is incorporated by 189 countries including Indonesia focused in an attempt to resolve the issue. United Nation explained that the millennium goal targets yet to be finalized at the end stage of the Millennium Development Goals (MDGs), but will be refined through second stage, known as the Sustainable Development Goals (SDGs). Poverty alleviation program is also strengthened more than 8 targets to 17 targets covering various areas one of which is education.

In education, the target of improving the quality of education has not been achieved throughout the world. The average of the total estimated 59 million inhabitants there is 1 (one) of 5 (five) children in the world who still do not get a school education, so that the gap to the field of education is still very big for the international community. Thus explicitly challenge the world community to poverty reduction is still very large including Indonesia.<sup>f</sup>

Indonesia is a big country with a total population of almost 220 million inhabitants and illiteracy is very large. Based on BPS data in 2015 showed that as many as 17.77% of the total population still suffers from illiteracy. This percentage also decreased in the period of 5 (five) years which amounted to 28.02% in 2011.<sup>g</sup> Under these conditions, it is important for the government to pursue educational backwardness alleviation by creating a Smart House program (RUMPIN) as a means to educate the community through non-formal education is no age limit.

Major Infantri Mr. Markuat as an Executor of RUMPIN said that, the first lady, Ani Yudhoyono played a role in the welfare of the nation together Solidarity of United Indonesia Cabinet Wives (SIKIB) initiated the "Indonesia Pintar" program. The main objective of "Indonesia Pintar" program is to realize the knowledge society, a prosperous society (welfare society) and a civilized society (civilized society). Smart house is one means of learning which can be a force for the nation which has an important role as a bridge towards mastery of science as well as a recreation area pleasant and refreshing for children ages 2 - 15th. Smart house made an important contribution to disclose information about science and aims to be at the heart of the life of the rural community activities, because with the smart house can be obtained data or information that can be used as the basis for the development of science and can add to the family income.

Smart house first in Indonesia in the wake of the 1st Infantry Division of Kostrad inaugurated by the First Lady on May 1, 2009 under the name Smart House Chakra Wise 1. The purpose of choosing the location of smart house in the Kostrad Cilodong Dormitory Complex, to improve citizen communication Infanteri- Division 1 Kostrad with Cilodong society, and strengthen the sense of togetherness among the soldiers of the army with the people so that oneness TNI (*Tentara Nasional Indonesia*) -people can be created. Smart house occupies a land area of 8,000 square meters with a building area of 358 square meters, consisting of 6 rooms with 8 centers, which include: the central computer, centers read, centers of audio-visual center of the play, the center of the craft, the central laboratories, centers outbound, and a center for food security. In addition, the smart home is intended not only to residents of the complex, but also for the wider community around Cilodong. Existing activities in smart home are as follows:

---

<sup>f</sup> <https://sustainabledevelopment.un.org/sdg4> accessed on, September 22, 2016

<sup>g</sup> <https://www.bps.go.id/linkTableDinamis/view/id/1056> accessed on October 20, 2016. This data is taken from the average of the estimated age of 15 to 44 years.





Figure 1. a. Operations manager and manager of the smart when Apple to initiate daily activities  
b. Smart House building Chakra Cendekia I



Figure 2. a. Practice Centra, b. Library c. Computer laboratory



Figure 3. a. Centra play, b. Centra Practice, c. Centra *Outbond*

## G. Conclusion

Based on the description in the previous section, it can be concluded that the Army provide support in order to improve the quality of education by building smart house, manage and provide the infrastructure to carry out activities through some varieties of activities contained in it, such as the centre of computer, the center of Audio visual, center of Practice, center of outbound, center of agricultural, and center of books. In addition, the Smart House Chakras Scholar-1 uses the principle of learning, playing and practicing in the learning process, which in turn can help the government in the formation of mental, physical and leadership of the nation. Through the Smart House, people in the region have gained Cilodong forms of non-formal education quality. Through computer centers, the public get information on the Internet, helping to increase the level of internet literacy. Sentra through livestock and agriculture, people gain knowledge about how to grow crops and raise livestock productively so as to improve the economic welfare of the community; while the craft

community centers are trained to be able to hone their skills and also increase the productivity of the community to achieve a better standard of living better, for outbound centers functioned to train the ability to think and motor skills; whereas for the audio-visual center, people are trained to improve the ability of arts and culture. Thus, it can be seen that the Army helped the government that plays a role in improving the quality of non-formal education based on the goal of sustainable development through the framework SDGs 4 points.

## H. References

- Arikunto Suharsimi and Suhardjono, Supardi. 2010. Classroom action research. Jakarta: PT Bumi Aksara.
- Faculty of Education, University of Yogyakarta, 2012, Smart House, Smart Park and Smart Communities. Directorate of Public Education, Directorate General PNFI The Ministry of National Education and the Department of School Education
- Maimun Sholeh, the roots of poverty and dependency in developing countries in structuralist perspective dependensia described in the site [file:///C:/Users/usee/ Downloads/Akar%20Poverty %20%20 and%20Depedency%20di%20Coutries% 20 flourish %20in%20 Perspective %20 structuralist %20 dependencies % 20\(1\).pdf](file:///C:/Users/usee/Downloads/Akar%20Poverty%20%20and%20Depedency%20di%20Coutries%20flourish%20in%20Perspective%20structuralist%20dependencies%20(1).pdf). accessed on June 14, 2016 o'clock 12.34
- Wahyu Surakusumah in "Linkage studies of Education for Sustainable Development (Education for Sustainable Development) Education Technology Association (Basic Technology Education) "which can be downloaded in the website [http://file.upi.edu/ Directory / FPMIPA / Education\\_ Programs \\_biologi / 197212031999031WAHYU\\_SURAKUSUMAH / Assessment of Education for Sustaineble Development.pdf](http://file.upi.edu/Directory/FPMIPA/Education_Programs_biologi/197212031999031WAHYU_SURAKUSUMAH/Assessment_of_Education_for_Sustaineble_Development.pdf) linkages. accessed on June 15, 2016.
- <https://sustainabledevelopment.un.org/sdg4>. accessed on September 22, 2016.
- <https://www.bps.go.id/linkTableDinamis/view/id/1056> accessed on October 20, 2016.
- Interview with executor of Smart House Cakra Cendekia I, Major Infantri Markuat on June 16, 2016

**Topic :** Sosio-Humaniora

**Moms' War and the Misconception about  
"Ryosai Kenbo" and "Kyoiku-Mama":  
Case of Educated Middle-Class Women in Indonesia**

Nunuk Endah Srimulyani<sup>1</sup>

*Chiba University, 1-33, Yayoicho, Inage Ward, Chiba-shi, Chiba, 263-8522 Japan*

---

**Abstract**

Due to the rapid growth of internet users in Indonesia, mothers, who are socially connected through social media, have been involved in an ongoing debate topic: the ideal mother: stay-at-home moms versus working moms. Participants use religious dogma, a theory of parenting from psychology, philosophy of education and even sociology in the debate. One of the more popular models proposed is the positive image of "ryosai kenbo" and "kyoiku-mama", two Japanese styles of motherhood and child rearing, which are virally spread by social media. Through in-depth interviews with married women (aged 20s -40s) who live in urban areas and are university graduates, this research was aimed to find out the various perceptions of the ideal concept of motherhood and child rearing standards among educated middle-class women, which were represented in the so-called moms' war conducted over social media. Based on subsequent analysis, the researcher found that (1) the moms' war on the social media showed the transition of motherhood style and changes in child rearing standards in Indonesia, (2) the misconception of *ryosai kenbo* and *kyoiku-mama* in Indonesia was caused by inadequate information about the history of Japanese family sociology, especially the social welfare system and sexual division-of-labor in the Japanese workplace, and (3) the Indonesian urban family model had changed from the extended to nuclear family, resulting in captivation by the ideology of child-centeredness that frequently happens in the middle-class family.

---

<sup>1</sup> Corresponding author: Tel. +81-(0)43-251-1111

E-mail address: [nunuk.srimulyani@gmail.com](mailto:nunuk.srimulyani@gmail.com)

## Keywords

mom`s war; ryosai kenbo; kyoiku-mama; middle-class; women

### 1. Introduction

In the 2010s, social networking users in Indonesia were shaken by a meme satirizing a working mom using a babysitting service to take care her child while she was working outside. The meme was of a picture of a child asking his/her mother whether she would trust other people to take care of her jewelry. The mother of course answered “NO”-followed by another question by the child: “Then why do you trust a nanny to take care of me?” In short, the meme was trying to compare how a mother treats her most valuable things differently, in this case, a child and jewelry.

Another meme gave an example of two men discussing their wives’ activities. The first man had a wife that quit working to be a stay-at-home mom while the other’s wife continued her career. The question that was posed was: “Isn’t it a waste to have a highly educated wife who just stays at home?” The second man replied with a question of his own: “Isn’t it a waste to let your child be raised by a poorly educated maid?” The meme tried to suggest the importance of early education for a child.

There are many debate topics that are brought up in the world of parenting, for instance: which is better--using disposable diapers or cloth diapers? Exclusively breast milk or formula? The age when a child should start to read and to write, etc. Among these topics, the concept of the ideal mother has become the most popular in the debate. That is to say, the comparison between working moms and stay-at-home moms.

It is a fairly recent development that the parenting world debate uses memes and other information that are virally spread in social media. And these viral concepts are so scientifically framed that people are easily convinced. Proponents use various social theories (especially psychological and child education theories) as well as religious dogma. Other participants, including motivational experts and religious leaders added various other interpretations of this topic, especially one involving sexual division-of-labor from social and religious points of view. Interestingly, they also brought forward various social phenomena and motherhood philosophies from developed countries to promote a positive image of stay-at-home moms (*ryosai kenbo* and *kyoiku-mama*, Japanese styles of motherhood and child rearing).

When and why did working moms versus stay-at-home moms start to be debated? In fact, historically Indonesian and Southeast Asian peoples belong to “dual earner” societies (Reid, 1993). Women living in rural areas probably will not seriously debate this topic since most of them have always been asked to participate in managing the farmland. Basically, the debate about motherhood philosophies and child rearing standards that has gone viral in social media is found principally in urban populations with adequate digital literacy. This phenomenon needs to be further explored in order to capture the social transition that has occurred in society.

#### 1.1. Objectives of the Study

This paper sought to determine the various perceptions of the ideal concept of motherhood and child rearing standards among educated middle-class women, which

were represented in the so-called moms' war conducted over social media. Three questions were asked.

1. What is the ideal conception of motherhood described on social media and how do urban women respond to it?
2. How are *ryosai kenbo* and *kyoiku-mama* interpreted in the Indonesian moms war?
3. How can this phenomenon be captured and explained from a sociological point of view?

## 1.2. Method

This was a qualitative study using in-depth interviews as a method of collecting data. The participants involved in this study were 35 married women (aged 20-40 years old). All participants had at least a diploma degree and lived in urban areas. The interviews were done from August 2014 until May 2015. Afterwards the information collected was confirmed through email or social media interaction.

The locations chosen were four big cities that were considered representative of the diversity of urban areas in Indonesia: Jakarta (including JaBoDeTaBek areas), Bandung, Yogyakarta, and Surabaya (including Sidoarjo and Gresik). In the preliminary study, blog writers focusing on child rearing and day care from the four cities were more active than those in other cities in Indonesia.

## 2. Looking for the Ideal Mother Concept through the Indonesian *Moms' War*

As has already been mentioned, the most trending debate topic in social media has been working moms versus stay-at-home moms. That topic was discussed even more after a religious leader (namely Felix Siauw) and a motivator (Mario Teguh), a net celebrity, updated Facebook their status and tweeted about the topic.

In a random search of the moms' war topic on Twitter on March 10 2011, a woman tweeted "A stay-at-home mom is sometimes jealous of working mothers, but a working mother, in her heart, wants to be a stay-at-home mom who can control her child's development." Or another tweet in 2012: "Working moms grumble in their hearts! Missing their children and feeling like they are not taking care of their children has become their daily diet."

The debate about working moms vs stay-at-home moms does not stop on Twitter and Facebook. On 'Kaskus', the largest internet community in Indonesia, a poll was conducted of men in February 2013; its principal query was "If you are married, do you prefer your wife to be a stay-at-home-mom?" As much as 74% of male respondents answered 'yes' to this question.

Various reasons were voiced, including the importance of continuing R.A. Kartini's advocacy of women's emancipation by supporting working moms, while those who preferred stay-at-home moms argued that getting wives to stay at home was part of a man's pride and that the old paradigm of stay-at-home moms badly needed to be reinforced. Some even claimed that Japan's economic sector had been devastated as the result of Japanese women becoming infatuated by western feminism and starting to work outside like men. This example indicates that Indonesian people do not understand the 1997 and 2008 Financial Crisis very well and blame women for its impact on Asia.

### *2.1 "Part Time Mom" vs "Full Time Mom"*

The Moms' War then escalated when Felix Siauw issued a tweet on May 28 2013 "if a woman spends only three hours for her child and eight hours to work, which one is better for them, to be called as a mother or a worker?" The next two days in May, 2013, Felix Siauw posted 44 points about the importance of being a stay-at-home mom on Facebook; the points were his father's advice before he converted to Islam. The moral lesson of this post was that being a stay-at-home mom was a noble job for a woman. It is not only a teaching in Islam, but is also an ideal in Chinese-Christian families. From the sociological point of view, this is actually surprising since Felix appears to be questioning the "dual earner" culture which is widely reported among Indonesian and Southeast Asian people. In the last point Felix added a sensitive sentence: "However it is a matter of choice, whether to be a "part-time mother" or a "stay-at-home mother". "You decide!" The status was liked by 27,000 accounts, commented 3,000 times and shared 24,000 times.

Felix' over-simplification of the issue--how perfect being a stay-at-home mom was and how being a working mom meant being a part-time mom, a victim of emancipation-- made the working moms' faction quite irritated. From all the comments about full-time moms vs part-time moms on Felix's status, we can distinguish three categories: (1) Pro: Those who are proud to be stay-at-home moms since it reduces many worries that mothers usually have, (2) Con: Those who work do not neglect their children and believe that their religion does not forbid women to work, (3) Indecisive: working moms confused about resigning or continuing to work.

### *2.2 "The Rib Ain't The Backbone"*

On March 15, 2014, almost a year after the Felix Siauw fuss, a famous Indonesian motivation expert conducted a poll on his official Facebook account, Mario Teguh Super Club, which asked: "Should a woman be the family and household manager, and should a man be the economic ability builder?" 5,054 out of 6,388 (79.12%) voters answered in the affirmative. Then, the poll result was broadcast on MTGW, a motivational TV program on the Kartini Day edition.

On April 20, 2014 (a day before the Kartini celebration), Mario Teguh posted a Facebook status: "There is no gender equality. Woman is more esteemed than man. She is the rib not the backbone". By mentioning that, Mario Teguh is emphasizing the concept behind Eve's creation from the Islamic and Christian views which maintain that Eve was created by God from Adam's rib. Therefore, a woman is meant to be loved; do not ask her to earn money and be the family backbone (breadwinner). Then, that kind of mythical point-of-view and quote became more and more popular. Based on an interview with one respondent in Yogyakarta, there were many stickers quoting that tweet found in her city (Ira, 40 y/o, former teacher in Yogyakarta).

### *2.3 Moms' War Trigger*

The rise of the moms war in 2013-2015 was also triggered by numerous mass media reports such as child abuse committed by maids which were also broadcast on the official Facebook page of the Indonesian Police Force, a major alleged crime of sodomy and pedophilia in a prestigious international kindergarten in Jakarta in 2014, and a child abuse case committed by the caregiver in Pertamina day care in September 2015. These major cases which attracted public attention raised the awareness of many people; they

believed that there was something wrong with day care and child care during this time, either caused by the nanny or child care institutions.

Numerous cases of child abuse become great ammunition for the moms' war on social media. Even the "maid's day off campaign" (April, 2015) which was intended to give holiday rights to maids in Singapore was twisted by Indonesian netizens. It was used to attack working moms and be the justification for stay-at-home moms. Based on observation of social media since 2011, the moms' war has been a never-ending topic of debate. For example, on April 21, 2016, a private radio station in Jakarta named JakFm posted the tweet: "Which one are you, a stay-at-home mom or a working mom?". Once again, Kartini day, which commemorates women's emancipation, always seems to be the right moment to question both woman's nature and the ideal concept of motherhood.

### 3. *Ryosai Kenbo* and *Kyoiku-Mama* as the Wanted Ideal Motherhood

Religious dogma is not the only reference for the moms' war, there are also *ryosai kenbo* and *kyoiku-mama*, motherhood philosophies and parenting styles from Japan, which were virally shared through social media, blogs, and the internet community. *Ryosai kenbo* literally means a good wife and wise mother, while *kyoiku-mama* is an education mother. At face value, there is nothing wrong with this term and it is no wonder Indonesian people claim it as the secret of Japanese society's success in educating their next generation. However, the term, which is quoted carelessly, raises a huge misconception of the reality of Japanese society.

Based on available blogs and articles discussing the concept *ryosai kenbo* and *kyoiku-mama*, almost all of them refer to Daoed Joesoef's (former Minister of Education and Culture 1978-1983) article written in an opinion column published by Kompas on July 7, 2007, which was also compiled by Waruwu (2010). Daoed Joesoef expressed his admiration for the ethical and disciplined behaviors of Japanese elementary students when they lined and organized their shoes neatly in the shoe rack at school. During his visit to Japan, he asked the teacher how she disciplined the children, and the teacher said, "I do nothing, their mothers teach them discipline."

#### 3.1 *Social Assurance behind Housewifization of Japanese Woman*

Daoed Joesoef's deep impression was supported by a paper from Tony Dickensheets (1998) entitled "The Role of Education Mother". He quoted Dickensheets' paper claiming that the miracle of Japan's economic growth since 1960 was not the result of government policy demanding 16 hours of work each day. In his opinion, Daoed Joesoef wrote:

"The key lies in the role of *kyoiku-mama* or education mama who is responsible for the children's education while the husband is working. Japanese education and the cultural system mainly rely on the woman's role in child rearing. Thus the woman has strong *ryosai kentro*<sup>2</sup> (a good wife and a wise mother) principle which determines the woman's role as the household manager and children's caregiver".

---

<sup>2</sup> The misspelling of "*ryosai kenbo*" (= "*ryosai kentro*") by Daoed Joesoef is followed by other writers in blogs,

It is true that *kyoiku-mama* and *ryosai kenbo* philosophies indirectly influenced Japanese economic growth after World War II, but the Dickensheets' view of the value of *kyoiku-mama* in Japan which was carelessly quoted by Daoed Joesoef is a fundamental mistake. Embroiled in political conflict, the *ryosai kenbo* philosophy actually contributes to expanding women's responsibility for household activities, leading to the domestication of women. It allows her husband able to work effectively and her children to concentrate on their lessons at school or outside courses which could last for 16 hours a day.

Unfortunately, Dickensheets does not recognize the sexual division-of-labor inherent during the era of Japan's economic glory which adhered to the concept of lifetime employment. Lifetime employment ensures a worker job promotions and salary raises, and the worker will not be fired from his job as long as he does not commit serious mistakes. This lifetime employment makes the Japanese worker willing to give over his entire day to working because the company also provides many kinds of family allowances. However, conditions are now quite different following the economic upsets of the last few decades.

In fact, not all university graduate women agreed to be stay-at-home moms as Dickensheets and Daoed Joesoef said in their papers. At that time, of course, Japanese women who really wanted to be housewives and did not want to work were not a minority. But many of them also quit from their job to be housewives due to the certain circumstances in the workplace. Until the early 90s, a company never gave a woman an important position because the assumption was a woman would get married, have children and stop working. No matter how skilled she was, she only ended as an office lady whose job was making a cup of tea.

A work environment which is dominated by men makes it hard for the women to get higher positions in an institution. This condition is called *garasu no tenjo* (glass ceiling phenomenon), an unseen obstacle which forces a woman to give up on her career. *Ryosai kenbo* philosophy which claims the woman is the one responsible for education and household activities causes a fundamental problem balancing career and family life. A woman feels guilty when she cannot meet society's standards for managing family matters as well as giving full attention to and proper education for her children. Nowadays, *ryosai kenbo* is said to be a *shigo* (dead word). Due to the political views against women involved in *ryosai kenbo* education policy in the Meiji-Taisho era, this philosophy is no longer the pride of Japan (see Koyama, 2012).

### 3.2 *Kyoiku-mama and Social Problems*

Dickensheets and Daoed Joesoef's second mistake is using *kyoiku-mama* terminology without investigating its definition and background before it became popular in Japanese society. A title which uses a special terminology from raw translation without knowing its proper use in Japanese society is a very serious mistake. Literally, *kyoiku-mama* means education mother and there is no negative connotation at all to it. The expression is value-free in Indonesia but not in its culture of origin.

---

internet community, and social media.



As for *ryosai kenbo*, some Japanese claim it as a positive value although sociologists and historians often blame it as the cause of the “care regime” in Japan which burdens the woman with responsibilities in all caring activities (rearing and educating the child and caring for the elderly). Consequently, *kyoiku-mama* can be a pejorative statement used for Japanese mothers who do everything for their children’s success at school (Honda, 2013: 462).

According to Honda Yuki (2013), *kyoiku-mama* is not a scientific term (*gakujutsu yougo*); it is just a popular expression used in Japanese society and the use of which spread during the Japan economic glory-years after WW II. Now, it is rarely used in daily communication or in mass media. A *kyoiku-mama* is different from other moms who pay attention to her children's education. There is negative element contained in the term *kyoiku-mama*. The term was firstly used in the 1960’s by “Sunday Mainichi” magazine. Then in the 60’s-70’s, it was used many times by other newspapers and mass media which made it a popular expression. One of Japan’s largest newspapers, Asahi Shinbun, decided to stop using the term *kyoiku-mama* in 1979, followed by Yomiuri Shinbun in 1980 (ibid).

In contrast to Dickensheets, Daoed Joesoef, and the opinion of many Indonesians, *kyoiku-mama* has had a bad impact on Japanese society. During those years (1960’s-80’s), many children committed suicide and left a suicide note saying something like “*okasan baka*” which means *f\*\*\*\* you mom*. There were also some mothers who stole examination questions from the teacher’s room. In addition, many children became spoiled brats because their mothers gave them all they wanted; they had nothing they had to do other than studying.

Japanese sociologists concluded that the *kyoiku-mama* phenomenon was caused by “*Shinchuusankaikyuu*”, the new middle class in the pre-WW II era who were willing to sacrifice anything for their children’s education. Before WW II the *kyoiku-mama* phenomenon only existed in a certain social class. However, after WW II many people started to behave like that. The worse thing was that all the attention to education was focused on academic standing (high scores, enrolling in prestigious schools, etc.) not on any ethical qualities (manners and attitude, etc.).

Compared to Honda Yuki’s research on *kyoiku-mama* (2000 & 2013) and Koyama Shizuko’s research on *ryosai kenbo* (1999 & 2013), Dickensheets’s paper contributes to the misconception of *ryosai kenbo* and *kyoiku-mama* philosophy. This misconception was also expressed by my respondent, Ira (Yogyakarta, 40 y/o). She really admires *ryosai kenbo* and *kyoiku-mama* after reading her friend’s status on Facebook who is in Japan for her doctoral study. Ira envies Japanese women who are educated but do not follow her ambition to pursue her career. She thinks Japanese woman dedicate themselves to take care of the family and especially the children's education exactly as written by Daoed Joesoef and Dickensheets. Ira and most Indonesian people who have read about the greatness of *ryosai kenbo* and *kyoiku-mama* do not know the social background behind it.

Under this illusion, it is clear that many Indonesian people admire and envy Japanese women who are willing to become stay-at-home-moms because of their persistency in the mentality and work ethic rather than focusing on money or luxury items. It is, in fact, dissimilar to Japanese society in the Showa era with regard to the housewives phenomenon in United States in the 70s which was more focused on material prosperity, especially in the Western-style layout of the home and modern kitchen appliances<sup>3</sup>.

---

<sup>3</sup> In the 1950s black and white television, washing machine, and refrigerator were known as the “*sanshu no jingi*” or “three sacred treasures” which also means the three essential status symbols in Showa era, and

#### 4. Ideology of Child-Centeredness of the Urban Family in Indonesia

It is an interesting phenomenon that nowadays most working moms in Japan envy the working moms in America. American working moms are able to take a business trip without worry since they hire babysitters to take care of their children. So, like the working moms in Taiwan and Singapore, they can enjoy working and still have lots of time to be with their children and family because, when they come home, their houses are neat and food is already served on the table thanks to the in-house-maid they have hired. Many Japanese working moms believe that it is too good to be true in Japan (See Sasagawa, 2015).

In contrast, among middle-class working moms in Indonesia, there is a newly developing idea that a baby should be raised and educated by his/her own mother, not by grandparents or nannies. Lots of Indonesian mothers even question the existence of day care centers since there are not many qualified day cares here. That is why it is not surprising if the *ryosai kenbo* and *kyoku-mama* philosophies are welcome and interpreted positively on social media's moms' war. It is such an irony since the philosophies are criticized seriously in their own country.

##### *4.1 Children's Education as the main issue of the Moms' War*

Based on the in-depth interviews conducted in this study, the moms' war had a negative effect on the condition of working mothers in real life. Generally, it affected their emotional state, but in many cases it was not enough to make them quit their jobs. For example, Vero (Jakarta, 30 y/o) said that she was very hesitant to leave her children. "It is unfortunate, others would like to be a civil servant but you would like to quit your job," said one of her neighbors. Hearing that, it made her reverse her decision to resign.

Another respondent, Mala (Jakarta, 40 years old) stated that she needs to work since it is impossible to meet her family's needs relying on only her husband's income in a metropolitan city. Additionally, she and her husband have postgraduate degrees, so she wants her three children to have higher educations and brilliant careers. Regarding the meme "A child is god's gift, why should we give him/her to the maid or daycare?", she responded that she chose the proper day-care carefully, we don't trust our children to be taken care of just anyplace. Mala also rejects one of the moms' war's issues regarding the doubt that working mothers could educate their children properly.

"My first and second children said that they are more proud of having a working mother rather than a stay-at-home mother. Working mothers have a larger network and links; they are also well-informed, so they can make good decisions when their children need help."

Although she is on the working-mother side, she respects women who choose to be stay-at-home moms. When she was asked about the potential of having a home business or a trending online shop, Mala chose to stick with her decision since she felt that she did not have any ability in that field. In line with Mala, Alia (31 years old), a respondent from

---

then replaced by 3C -Color television, Cooler, and Car in the 1970s (See Yoshimi, 1999 & 2005).

Surabaya, said that she is the 'product of a working mom' and does not feel that her mother failed to educate her since she could pursue a higher education and get a stable career.

Religious views as to the appropriateness of woman being stay-at-home mothers got various responses from Islamic and Christian figures in the social media recently. Iva (Surabaya, 40 y/o), a senior high school headmaster and a *Nahdlatul Ulama* activist, stated that, in Islam, a man is the leader of the woman but that does not mean necessarily that she could not work and should always be staying at home. Similarly, Maria (Surabaya, 40 years old) who is a Christian kindergarten and daycare headmaster said that educating and caring for the children is the mother's duty, but it does not reduce a working woman's dignity as long as she can entrust her children to the right people.

Nonetheless, many housewives believe that they are on the right side of the moms' war. Linda (Jakarta, 29 y/o) was afraid of the prevalence of child abuse cases in the mass media and social media, therefore she finally decided to quit her job and to dedicate herself as a stay-at-home mother. On the other hand, Ana (Yogyakarta, 30 y/o) quit her job because of religious reasons. She said that she was very happy and at peace after quitting her job as an engineer in a multinational company since she could concentrate on taking care of her child. She blamed herself when she was busy working in France and her child was born with autism.

Ira (Yogyakarta, 40 y/o) who quit her job as a teacher, agreed to the statement 'a woman was born as a rib bone, so do not make her the back bone of the family'. She stated that she could not stand listening to many children crying when they are in the daycare near her home every morning. From her point of view, the economic condition of working mothers is not worse than hers so she wonders why they continue their careers and leave their children in a daycare. Moreover, she thinks that the standard of wealth is relative, it depends on how we manage it.

Meanwhile, Tina (Surabaya, 33 y/o) already declared herself to be a stay-at-home mom before the moms' war occurred. She is supported by her husband who has the same perspective on it. She quit her job in a foreign company and chose to become a stay-at-home mother since she experienced having a working mom in her childhood and she felt very lonely at that time. Furthermore, she said that her mother has replaced 17 housemaids and only one of them was sincere and nice to her. Other housemaids often repeatedly pinched her younger brother, and it has made her decide to be a stay-at-home mother. Tina was traumatized by the housemaids' attitudes in her childhood experience and considered that the financial independence of her mom, aunt and other female workers around her reduces their respect toward their husbands. As stated in her religion, a man is the leader of the family; this makes her sure that she would like to be a stay-at-home mom. Similar to Ira, Tina deplors that educated women have a career outside and leave their children in the day care just because of economic considerations.

#### *4.2 Academic Record Society and the Rising Middle Class*

There are many theories of who deserves to be called middle-class, but in general this designation usually refers to people who have fixed incomes, a house, private cars, savings and good education. The distribution of middle-class people in Indonesia in 2012, according to BCG (Boston Consulting Group), was 44% of the whole population. The income limits that were used in this survey were actually too low due to the inflation rate

of Indonesia. However, if the income limits from the BCG survey were used as an indicator to categorize the participants in this study, the participants of this study were definitely middle and upper-middle class people.

Even though the exact percentage of middle class in Indonesia is still debatable, many surveys show that economic growth and consumption in Indonesia are quite high. Nielson (2016) sums up that Indonesians are the 3<sup>rd</sup> most confident consumers in the world after Indians and Filipinas. In line with the previous data, Pew Research (2014) shows that 62% of Indonesian people believe that the next generation will have a better future and financial condition. Meanwhile, Global Consumer Survey (BCG) (2012) states that 91% of Indonesian people are optimistic that their financial condition is relatively secured compared to all of the countries in the world.

Indonesia is considered an academic record society, wherein children's education is regarded as a future investment. In fact, for religious people, a child is an investment in life and in the life after. In such cases, children's education is not only for survival in the world, but also for the parents' salvation in the afterlife. The successful birth control (KB) program in Indonesia shifts the society's orientation from having dependent families to core families that want to have the best education (including religion wisdom) and health for their children. They can no longer go by the number of children for their security; as the classic proverb says, 'many children means many meals.' Nowadays they tend to focus on the quality their children experience, specifically in education, not only academically but also in their understanding of religious teaching and morals. With this issue, we can see that the ideology of child-centeredness is being adopted by Indonesian society, especially in urban areas.

## 5. Conclusion

Based on the explanation above, it can be assumed that the ideal mom that is visualized by the social media users and respondents is a mother who can take care of the family and educate her children. Working moms and stay-at-home mom both maintain that their decision to pursue a career or not is because they believe it is best for their kids. It is different from the statements of many working moms in the era of New Order in the "Satu Abad Kartini" - Kartini in a Century (1979) essays; nowadays the gender equality issue is not featured anymore in the choice of becoming a working mom or stay-at-home mom. The choices are usually affected by childhood experience and their understanding of the religious interpretation. It indicates the changing concept of motherhood and child education in Indonesia. A new standard of child rearing among middle-class mothers in Indonesia is illustrated by their regard for Japanese motherhood philosophy in the moms' war. The misinterpretation of the *ryosai kenbo* and *kyoiku-mama* concepts which are virally spread in the social media are basically caused by a lack of information about the history of Japanese familial sociology, especially regarding the social welfare system and sexual division-of-labor in the Japanese workplace. Dickensheets' paper entitled "The Role of Education Mama" which is quoted by Daoed Joesof in his opinion column, contributes to this misconception. As an academic record society with a continuously growing middle class, the Indonesian urban family model has changed from extended family to nuclear family and is unconsciously captivated by the ideology of child-centeredness as experienced by modern societies all over the world.

## References

- BCG Perspectives. (2012). Indonesia's Rising Middle-Class Affluent Consumer. [https://www.bcgperspectives.com/content/articles/center\\_consumer\\_customer\\_insight\\_consumer\\_products\\_indonesias\\_rising\\_middle\\_class\\_affluent\\_consumers/?chapter=2](https://www.bcgperspectives.com/content/articles/center_consumer_customer_insight_consumer_products_indonesias_rising_middle_class_affluent_consumers/?chapter=2).
- Dickensheets, T. (1998). The Role of Japanese Education Mama. In Beauchamp, E.R. (Ed.). *Education and Schooling in Japan since 1945*, p. 277-282. Garland Pub.
- Honda, Y. (2013). 'Kyoiku-Mama' no Sonritsu Jijo. In Koyama S. (Ed.). *Kodomo, Kazoku to Kyoiku*. (Ronshuu Gendai Nihon no Kyoikushi/Tsujimoto Masashi Kanshuu, 4) Nihonzusho Senta.
- Joesof, D. (2010). *Kyoiku Mama*. In Waruwu, F.E.. *Membangun Budaya Berbasis Nilai – Panduan Pelatihan bagi Trainer* p. 90-94. Yogyakarta: Kanisius.
- Katoppo, A. (1990=1979 1<sup>st</sup> edition). *Satu Abad Kartini – Bunga Rampai Karangan Mengenai Kartini*. Jakarta: PT Sinar Agape Press.
- Koyama, S. translated by Stephen Filler. (2013). *Ryosai Kenbo: The Educational Ideal of 'Good Wife, Wise Mother' in Modern Japan*. Brill.
- Nielsen. (2016). Confidence Concerns and Spending Intentions around The World. <http://www.nielsen.com/content/dam/nielsen-global/kr/docs/global-report/2016/nielsen-q1-2016-global-consumer-confidence-report.pdf>.
- Reid, A. (1993). *Southeast Asia in the Age of Commerce 1450-1680 Vol. One: The Lands Before the Winds*.
- Sasagawa, K. (2015). 'Tomobatarakinara, Futari dake de Kaji Ikuji Shinaide' Hausukiipaa wa Atarimae? Shingapooru no Kosodate Jijo. *Huffpost Lifestyle Japan*. [http://www.huffingtonpost.jp/2015/06/03/southeast-asia-house-keeper\\_n\\_7507394.html](http://www.huffingtonpost.jp/2015/06/03/southeast-asia-house-keeper_n_7507394.html)
- Yoshimi, S. (1999). 'Made in Japan': the cultural politics of 'home electrification' in postwar Japan. *Media, Culture & Society* March 1999 21:149-171
- Yoshimi, S. (2005). *Japanese Television*. in Wasko, J. (ed.). *A Companion to Television*. Blackwell Publishing.

(All of the website references are retrieved on October 10<sup>th</sup> 2016)

**Topic:** Socioeconomics Relations

**A Comparative Study of Economic Revitalization Policy in Coal  
Mining Areas Between China and Japan  
- From the Spatial Perspective**

Zhu xun<sup>a\*</sup>

<sup>a</sup>1-33, Yayoicho, Inage Ward, Chiba-shi, Chiba, 263-8522 Japan

---

**Abstract**

The resource-based cities are the cities which are driven by the exploitation of mineral, forests and other natural resources, and the leading industry is based on the processing of those resources. The resource-based cities have been providing a lot of energy for the development of China, but around 2000, the economic depression of resource-based cities began to arouse people's attention. Regarding to restore resource-based cities to growth, after the implementation of a series of related stimulus plans in past decade, finally, Chinese government enacted the *Sustainable development plan of resource-based cities* in 2013.

According to my research, there is a similar experience in Japan. Given that the transformation of industrial structure and energy structure in 1960s, the coal mining areas in Japan entered the period of economic stagnation. And then, Japanese government passed *Act on Temporary Measures concerning the Vitalization of the coal mining areas* in 1961. Based on the policy, a series of economic revitalization policies was in force. Now, the transformation of economic structure in some coal mining areas has succeeded.

In this paper, the differences of economic revitalization policy between China and Japan will be compared from the spatial viewpoint. Based on comparative study, the importance of spatial viewpoint applied in regional economic policy making will be reconsidered, and the problems of policies in China will also be concluded. As a case study, the development of automobile industry in North Kyushu will be provided.

**Keywords**

Keywords: Resource-based cities; Coal mining areas; Spatial distribution; Economic transformation

---

**1. Introduction**

First, the principle that economic revitalization through the advancement of the industrial structure in the previous researches will be discussed. To achieve the

---

\* Corresponding author. Tel.: +81 -(0)80-6579-2706  
E-mail address: shujin616@chiba-u.jp

advancement and upgrading of industrial structure, those resource-based cities highly dependent on resource exploitation could, develop the downstream industries, and enhance Industrial competitiveness by increasing added value of the resource products. Thus, in the future, even if the resource was exhausted, the resource-based cities could also realize economic growth by resource imports.

In previous researches, the principle based on following three assumptions. First, the added value rate in each processing stage is constant. In this paper, it is set as  $\alpha$ . Second, the production in each processing stage will flow into next stage as raw material in a constant ratio. In this paper, it is set to be  $\beta$ . It means that the ratio of  $1 - \beta$  of total production is consumed. Third, other costs including transportation costs is set to be 0. It means that production value is the sum of the raw material value and added value (Hara, 2007, pp. 116-117). Through the three assumptions above, the production value of raw material and the added value in each processing stage are as shown in table below:

Table 1. The added value and production value of raw material in each processing stage

	Primary Processing	Secondary Processing	Tertiary Processing	...	N times processing
Raw Material	$Y_1$	$\beta Y_1(1 + a)$	$\beta Y_1(1 + a)^2$	...	$\beta^{n-2} Y_1(1 + a)^{n-1}$
Added Value	$\alpha Y_1$	$a\beta Y_1(1 + a)$	$a\beta Y_1(1 + a)^2$	...	$a\beta^{n-1} Y_1(1 + a)^{n-1}$
Production Value	$Y_1(1 + a)$	$\beta Y_1(1 + a)^2$	$\beta^2 Y_1(1 + a)^3$	...	$\beta^{n-1} Y_1(1 + a)^n$

According to the table, the added value that the enterprise could earn is determined by three variables. It means that the higher added value ratio, the higher ratio flow into next stage as raw material, the more processing stages there are, the more added value that the firms could earn. Therefore, regional economic revitalization is focus on following points: How to have improve the raw materials flow into next stage, how to improve the added value rate, and how to improve the processing stage (Hara, 2007, pp. 116-117).

As what other methods show us, the new industrial development way is pointed out. The new way of industrial development is that resource-based cities should establish the new industries that not rely on the existing resource through the accumulated capital, technology, and human resources by resource developing, and transform the labor from resource development to the new industries.

Talking about the transformation difficulties, the advancement of the industrial structure is considered as the easier one, but the new industrial development is the more radical one, because it gets rid of the dependence of resource. However, as the common points of the two methods, new firms or new investments are needed. In the previous researches, because the foreign investment could bring not only capitals but also advanced technologies, management, and concepts, so attracting foreign investment is considered the effective way to develop the new industrial. Obviously, it is also applicable to advancement of the industrial structure.

Based on the above viewpoints, around the problem about how local government to attract foreign investment, lots of studies had been done, and some local governments sacrifice their local interests to attract foreign investment. However, the relationship between firm locations and regional revitalization based on spatial viewpoint has not been paid enough attention. This paper will be divided into following parts. First, under the spatial viewpoint, the methods mentioned above may fail, we will discuss this possibility. Second, the spatial distribution of coal mining areas in Japan and resource-based cities in China will be plotted, then, the spatial distribution characteristics will be analyzed based on the plotted results. Third, the importance of spatial association will be

discussed. At last, as a case study, the development of automobile industry in North Kyushu will be provided.

## 2. Methodology

### 2.1. Theoretical model

According to the spatial economy (Fujita, Krugman, & Venables, 1999, pp. 120-126), in the spatial models of urban systems, because production costs are the same regardless of the location chosen, the problem reduces to one of minimizing transportation costs. The figure1 shows that how the total transportation costs of a producer located at  $s$  may be analyzed, given that all other producers are concentrated at  $\tau$ .

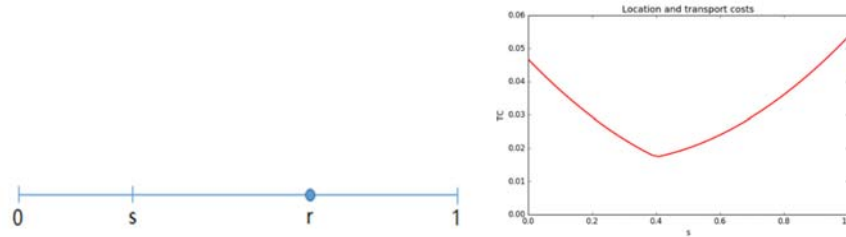

Figure1 Plant location; Figure2 Function of  $s$  (two accumulation points)

First of all, as shown in formula1 and figure1, the total transportation costs could be divided into three parts., the transportation costs of 0-  $s$ ,  $s$  -1, and  $r$ . Second, as shown in formula2, the transportation costs of each part are the product of transport volumes( $Q$ ), distance( $S$ ), and cost of per unit good transported one unit of distance( $V$ ). According to the above two formulas, the total transportation costs could be calculated as shown in formula3.

$$TC = TC_{0-s} + TC_{s-1} + TC_r \quad (1)$$

$$TC = Q * S * V \quad (2)$$

$$TC = \tau \left\{ \frac{1-\mu}{2} [s^2 + (1-s)^2] + \mu|r-s| \right\} \quad (3)$$

We could plot this total transport cost as a function of  $s$  for the parameters  $\tau=0.1$ ,  $\mu=1/3$ ,  $r=0.4$ . here, the parameters  $\mu$  is the share of the population that employed in manufacturing. Clearly, in this case the point of minimum transport cost - the optimal location of a firm choosing where to locate given the locations of other firms - is at  $s=0.4=r$ . This result continues to obtain in more satisfactory models. In the “market potential” function, an urban concentration normally both creates a cusp in the market potential function and is sustained by that cusp, which causes the existing urban location to be that function’s maximum (Fujita, Krugman, & Venables, 1999, pp. 124-125).

In this model, we only consider the case of one accumulation point that each firm chooses to locate where all other firms are located. This model also could be extended to two accumulation points. As shown in figure4, other assumptions remain unchanged, all the firms are located in  $r_1$  and  $r_2$ .  $r_1$  employs industrial population of  $\mu_1$ ,  $r_2$  employs industrial population of  $\mu_2$ , and the condition of  $\mu=\mu_1+\mu_2$  is satisfied. Through the similar calculation method as shown in case1, we could the total transportation costs could be calculated as shown in formula4 and plot the total transport cost as a function of  $s$  for the



parameters  $r_1=0.4$ ,  $r_2=0.6$ ,  $\mu_1=2/9$ ,  $\mu_2=1/9$ ,  $\tau=0.1$ . As shown in figure3, we can still see that the point of minimum transportation costs - the optimal location of a firm choosing where to locate given the locations of more firms - is at  $s=0.4=r_1$ . That means, firms will prefer the larger cities which could bring lower transportation costs.

$$TC_r = \tau \left\{ \frac{1-\mu}{2} [s^2 + (1-s)^2] + \mu_1 |s - r_1| + \mu_2 |s - r_2| \right\} \quad (4)$$

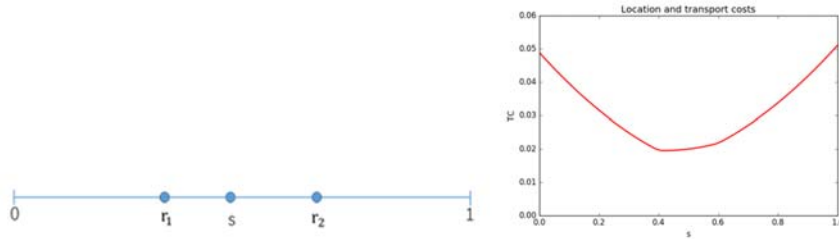

Figure3 Plant location (two accumulation point); Figure4 Function of s (two accumulation points)

In previous researches, Zhao (Zhao, 2007) pointed out that the city scale of resource-based city is smaller. And Liu (Liu, 2007) pointed out that the resource-based city located along the mines, with poor infrastructure, and away from the traffic trunks and developed areas. Therefore, according to the results in this section, we can infer that the resource-based cities will be of disadvantages when the firms consider investing and establishing plants. So, the policy effects may be less obvious if the policy only considers the resource-based cities.

## 2.2. The policy characteristics and spatial distribution of coal mining areas in Japan

Here are some concepts. First, the coal mining areas are the depressed coal production regions which caused by the depress of coal mining industry, and the regions connecting with it which has a close relationship with mining industry revitalizing. And then, in this paper, "article two region", "article six region", "article ten region" are the regions which are the object of article two, article six, article ten of *Act on Temporary Measures concerning the Vitalization of the coal mining areas*. According to *Act on Temporary Measures concerning the Vitalization of the coal mining areas*, "article two region" will be the aid object of the law. "Article six region" will be the object of loan for covering decrease in local tax revenues. "Article ten region" will be the object of interest subsidy for issuing municipal bond.

In this paper, the coal mining areas is chosen based on *Order for Act on Temporary Measures concerning the Vitalization of the coal mining areas* (2002.3.25). From the listed coal mining areas, the following characteristics will be found. First, "article six region" contained in "article ten regions", at the same time, "article ten region" contained in "article two region". Second, based on the characteristic one, it is clearly that the "article two region" has the largest number, the "article ten region" is the next, and the "article six region" has the least number. In reference of points based on "article six region", the number of more than "article six region" (added in article ten region), and also the number of more than "article ten region" (added in article two region) is decreasing. Third, based on the characteristic one and two, the "article six region" has the largest proportion, meanwhile, the "article six region" is aid object of article two, article six, article ten. So, it is obvious that article six is the main aid object of law, and the assistance intensity is decreasing from "article six region" to "article ten region".

Then, based on *Order for Act on Temporary Measures concerning the Vitalization of the coal mining areas*, the spatial distribution of coal mining areas in Hokkaido and Fukuoka-ken was plotted. According to the spatial figure, the spatial distribution characteristics are as followings. First, the “article six region” is located in the center area, the “article ten region” is distributed around the “added in article ten region”, and “the added in article ten region” is located at the extension of the “added in article two region”.

Overall, from the view of policy characteristics, there is an inclusion relation between each region, and from the view of spatial distribution characteristics, there is a connection relation between each region.

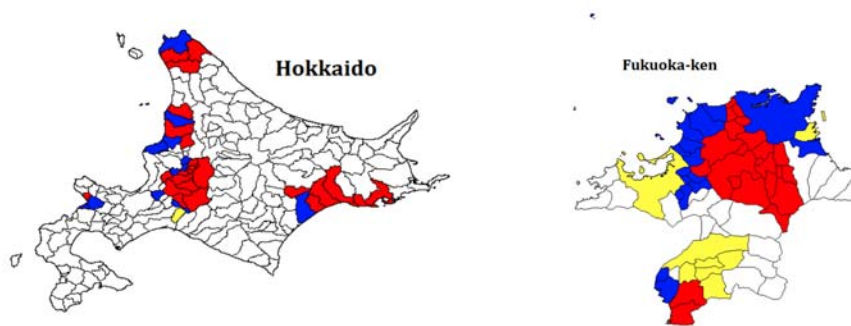

Figure5 the spatial distribution of coalfields in Hokkaido and Fukuoka-ken (yellow is the added in article 2 regions, red is the article 6 regions, blue is the added in article 10 regions.)

### 2.3. The policy characteristics and spatial distribution of resource-based cities in China

According to the policy, resource-based cities in China had been classified by 4 types. They are developing resource-based cities, mining resource-based cities, decline resource-based cities, and regenerate resources-based cities.

The developing resource-based cities are the cities which resource development in a rising stage. These cities have great development potential of resource, economic, social, and regarded as supply and reserve base of resource. The mining resource-based cities are the cities which resource development in a stable stage. These cities have a strong resource security capability, a higher development level of economic and social, and regarded as the core area of energy security at the present stage. The decline resource-based cities are the cities which resource reserves tend to dry up. In these cities and economically underdeveloped areas, livelihood and environment issues are serious. So, these cities are defined as the key and difficult areas in great need of being accelerated the transformation of economic development mode. The regenerate resources-based cities are the cities which get rid of resource dependence. These cities began to enter the track of Sustainable and healthy development, and become the leading regions of economic transformation of resource-based cities.

Refer to the characteristics of each type of resource-based cities, the policy has given a different guidance. For the developing resource-based cities, resource and city development based on a long-term perspective is of importance. For the mining resource-based cities, the upgrading of the industrial structure based on the high-level resource development is focused. For declining resource-based cities, how to promote economic transformation, and enhance sustainable development ability is a hot topic. For regenerate

resource-based cities, how to improve the efficiency of economic growth after the resource dependence reduced, and open wider to the outside world is focused.

Form the policy characteristics mentioned above, the relationship between each type of resource-based cities is hard to find. so, we selected Inner Mongolia as the developing resource-based region, Shanxi province as the mining resource-based region, Jilin province as the declining resource-based region, and Henan provinces as the common example to analysis the spatial distribution characteristics of resource-based cities in China, and determine if there is a relationship among each type of resource based cities.

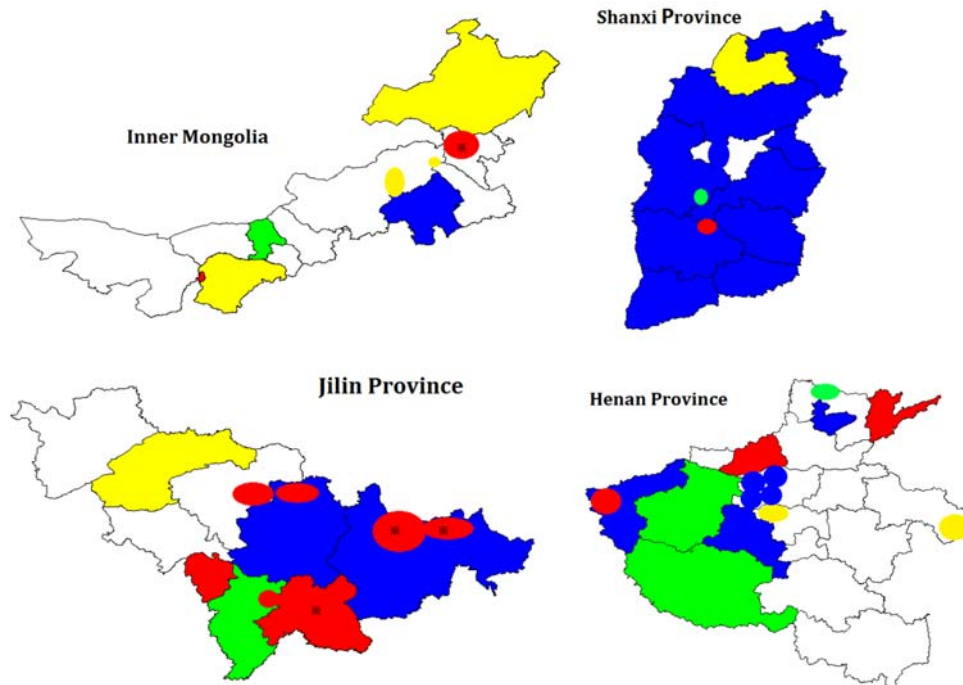

Figure 6 the spatial distribution of resource-based cities in China (yellow is the developing resource-based cities, blue is the mining resource-based cities, red is the declining resource-based cities, green is the regenerate resources-based cities)

From the results(figure6), in Inner Mongolia, almost all types of resource-based cities are related to the developing resource-based cities. In Shanxi province, almost all regions are mining resource based cities. In Jilin province, mining resource based cities, declining resource based cities, regenerate resource based cities are interconnected, while the developing resource based city are isolated. In Henan province, isolated developing resource based city, decline-resource based city existed, and interconnected regions also are exiting. Therefore, it is difficult to sum up the common disciplines from the results. At the same time, various resource-based cities have involved in policies, such as coal-based cities, forest industry based cities, so, there are examples which relate with each other, but the resource types of cities are different. Clearly, the concept like 'the regions connecting with it which has a close relationship with mining industry revitalizing' in Japan is not reflected in China's policy.

### 3. The importance of spatial association

About the benefit of firm cluster, input sharing, labor pooling, skill matching, and knowledge spillovers, all of which could generate higher productivity and lower

production costs indicated by O'Sullivan's work (O'Sullivan, 2012, pp. 45-64). However, due to the constraints of region space, with the increasing of agglomeration scale, higher commuting time, higher building density, and environmental issues will bring a negative impact on the firms which located in the agglomeration region. Therefore, the agglomeration scale is not the bigger the better, and it is considered that if the agglomeration scale exceeds the limitation, the agglomeration economics will be reduced.

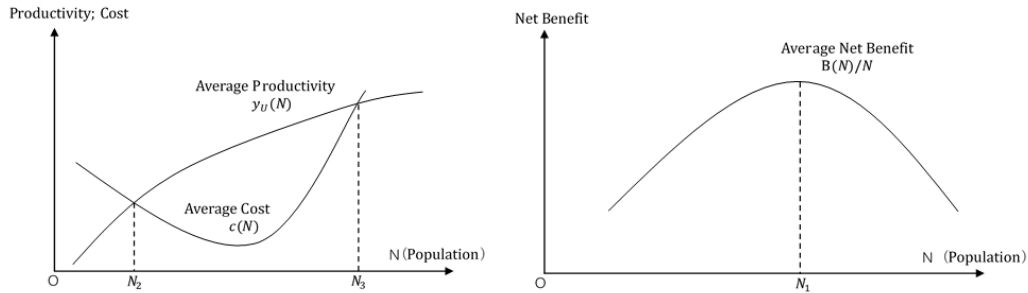

**Figure 7 the change of average productivity and average cost; figure 8 the change of average net benefit** (Nakamura & Tabuchi, 1996, pp. 34-35)

As shown in figure 7, the average productivity will increase with the expansion of agglomeration scale, however, the growth rate is decreasing. The average cost will decrease with the expansion of agglomeration scale, but after a certain scale, the average cost will increase at an increasing growth rate. Average net benefit is the value that the average productivity minus the average cost. From the figure 8, it is clearly that average net benefit is increased first, and reached the maximum at  $N_1$ , then decreased. In this paper, we called  $N_1$  the optimal scale of region.

In terms of the above theory, return to figure, minimum transportation costs will be achieved if a firm choosing where to locate given the locations of other firms, and when location point moves to both sides, the transportation costs is increased. Therefore, firms will give priority to the agglomeration region, when the optimal scale of region exceeded, part of the firms will locate on both sides of agglomeration region. Similar result is also showed in the two agglomeration regions model, but from the figure, we can see that the growth rate of transportation cost is slowly when location point move from larger agglomeration region to smaller one.

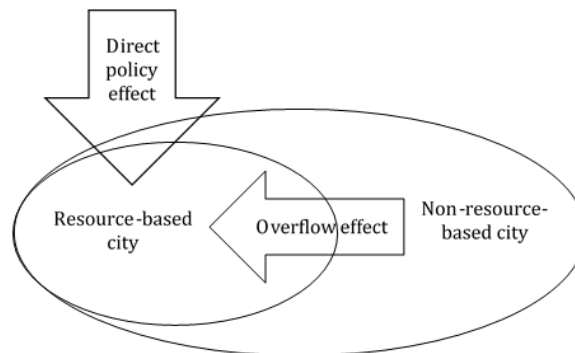

**Figure 9 the effect of regional revitalization policy in Japan**

So, as shown in figure 9, the effect of regional revitalization policy in Japan could be divided into two parts, one is the direct policy effect which brought from policy directly, and the other one is overflow effect which brought from the diffusion of agglomeration economics. the direct policy effect will be effective only when the benefit brought from

policy to firms can offset the disadvantages of transportation cost brought from the location select, and the direct policy effect need a sustainable policy helps the agglomeration economics reach a certain scale. Therefore, the direct policy effect needs huge input. However, the overflow effect is based on the regional development where the agglomeration economies have a comparative advantage. So, from the point of firm location, the input of the overflow effect is smaller, and more efficient.

#### 4. A case study of Japan

Next, we will explain the overflow effect through the relationship between automobile industry development and regional economic revitalization. Due to transformation of industrial upgrading and energy structure, the coal industry of Kyusyu began to decline in 1960. And Kyusyu began to economic transformation from coal industry to processing industry.

The development of the automobile industry in Kyusyu can be divided into three stages (Forum Fukuoka, 2007). The first stage is in 1970s. In 1973, through the industry location policy of Kitakyusyu, Kyusyu factory of Nissan automobile was established in Kanda-machi. Then, Engine factory started production from 1975, and vehicles factory started production from 1976. After the location of Nissan automobile in the first stage, the primary products manufacturers of automobile started active in Kyusyu.

The second stage is in 1990s. In 1991, Toyota Kyusyu factory was located in Miyaata-machi, and started production from 1992. And in 1992 the second factory in Kyusyu factory of Nissan automobile was completed. Through the second stage, the number of production in northern Kyushu automobile reached a peak of 613 thousand, accounted for 7.6% of the total in Japan. However, affected by Asian financial crisis, the number of production decreased after 1996.

The third stage is after 2003. In 2003, the promotion conference of million production base in northern Kyushu was established, then, Nissan and Toyota automobile began to strengthen the existing factory, and build new factories. At the same time, Daihatsu car body (Daihatsu Kyusyu) moved from Gunma-ken to Kyusyu in 2004. Through the development of the third stage, the number of production in northern Kyushu automobile reached 1million and 10 thousand, accounted for 10.1% of the total in Japan.

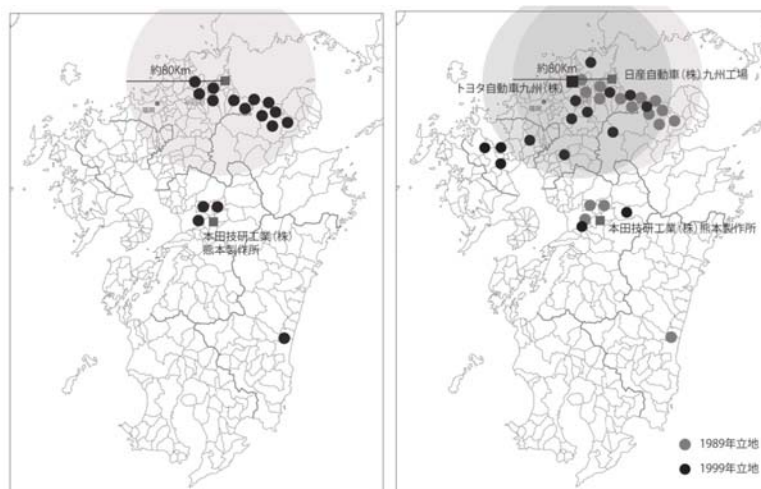

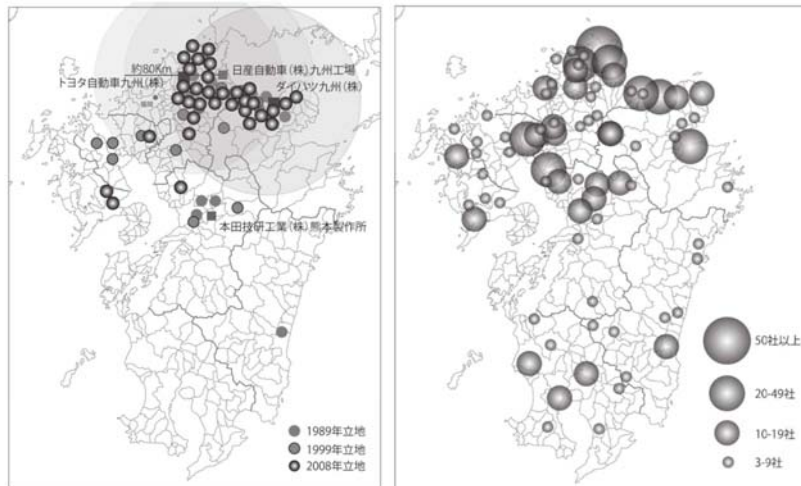

Figure 9 The change about location distribution of the first supplier of automobile industry (Kyushu Bureau of Economy, Trade and Industry, 2009)

After above three stages mentioned above, the development of automobile industry in Kyusyu is regarded as a successful model, and Kyusyu is known for a car island. The change about location distributions of the first supplier of automobile industry is shown in figure. In 1973, Kyusyu factory of Nissan automobile was located in article two region, and in 1989, the first supplier of automobile industry was mainly located in article two region and article ten region, in 1999, with the agglomeration scale in article two region and article ten region were strengthened, the agglomeration scale in article six region began to increase. In 2008, the agglomeration scale in all of article two region, article ten region and article six region was be strengthened. In general, the overflow effect is very obvious.

About the impact of overflow effect on the coal mining areas, the Miyaata-machi which located in Chikuhou, had begun the coal mining since the middle of Meiji period, and achieved long-term prosperity as a coalfield. After the mine closed, Miyaata-machi began to establish industrial park near the Wakamiya interchange of Kyushu expressway. With the convenience of transportation, abundant labor sources, and various funds established for regional revitalization, Miyaata-machi achieved success of industrial location through reducing the location cost of firms, and being referred to as excellent student of coalfields.

## 5. Conclusions

Firs, from a theoretical point of view, it is possible to help cities achieve region economic revitalization through the advancement of industrial structures and new industrial development. However, from the spatial perspective, the policy will face great difficulties in the implementation process if the policy object only affects the regions which most in need of assistances, and it may also lead to less policy effect. In the author's another research, effect of economic transformation policies in Henan province was be evaluated by compared with the indicators between resource-based cities and the non-resource-based cities which connecting with resource-based cities. The results have shown that in all the 61 indicators, only 15% account for a strong policy effect, and 5% of which have a weaker policy effect, in other words, the indicators which could be judged to be effective were only 20% in total (Zhu, 2016). This is a very disappointing result, and it also shows the influence that led by a lack of spatial viewpoint.

Second, through the analysis above, in the industry location policy, it is efficient that assistance to the developed regions which connecting with underdeveloped regions. Therefore, the revitalization policy should pay more attentions to those regions. And for the underdeveloped regions, such as infrastructure constructions, quality of labors should be paid more attentions, because they could reduce the location cost of firms effectively, and accelerate the agglomeration economics to underdeveloped regions from developed regions.

## References

- Forum Fukuoka. (2007). The progress of automobile industry in Kyusyu - Why the Kyusyu become a major base of automobile production. *Forum Fukuoka*, 16-21.
- Fujita, M., Krugman, P., & Venables, A. J. (1999). *The Spatial Economy - Cities Regions, and International Trade*. London, England: The MIT Press.
- Hara, I. (2007). *The new development of regional economics*. Toga Shuppan.
- Kyushu Bureau of Economy, Trade and Industry. (2009). *Market trend survey about the automobile industries in Kyushu Investigation report(2008)*. Kyushu Bureau of Economy, Trade and Industry.
- Liu, j. (2007). *Research on resource-based cities' transition and sustainable development in China*. Central south university.
- Nakamura, R., & Tabuchi, T. (1996). *Urban and regional economics*. Yuhikaku Publishing Co., Ltd.
- O'Sullivan, A. (2012). *Urban Economics*. Singapore.
- Zhao, j. (2007). *The study of the urban spatial development of the resource-based city in China*. Northeast normal university.
- Zhu, x. (2016). A study on the effect of economic tranformation policy for resource-based cities in China: A case study of Henan province. *Studies on Humanities and Social Sciences of Chiba University*, 32, 77-100.

---

**Analysis on the Research Trends of CALL in China  
--Based on the Papers from CNKI from 2010 to 2016**

**Xing, Yun\***

*Chiba University, Chiba-Ken, Chiba-shi, Inage-Ku, Yayoichou 1-33, Chiba-Shi, 263-8522, Japan*

**Abstract**

CALL (Computer-Assisted Language Learning), considered to be a young branch of applied linguistics with dynamic characteristics, has developed more than 50 years and programs about CALL, such as drill and testing have appeared since 1950s in the United States. While it was not until 1980s that CALL appeared in China, CALL has gradually come to develop quickly in the past 30 years. Lots of researchers have explored the characteristics of CALL in China in the past few years. The research areas are mainly focused on the theories about CALL; teachers' roles or attitude toward CALL; students' attitude toward CALL; language testing based on CALL; technology or software about CALL etc.

This paper attempts to analyze the development trend of CALL in China based on 120 articles selected from CNKI (China National Knowledge Infrastructure) from 2010 to 2016. Adopting the statistical analysis method and literature review, this paper aims to investigate the development tendency of CALL in China, make conclusions about the hot spots of CALL in recent years based on the high-frequency keywords of the 120 articles, and find out some advantages or disadvantages about CALL in China. Finally, suggestions will be made for the problems of CALL in China.

**Keywords**

CALL; development tendency; hot spots; statistical analysis; literature review

**1 Introduction**

With the development of technology, computer gradually plays a key role in language education. CALL (Computer-Assisted Language Learning) is considered to be a young branch of applied linguistics according to Ken Beatty (2003: 2). The following analysis about CALL by Ken (2003: 1) is noteworthy:

CALL is a subject tied tightly to other areas of study within applied linguistics such as autonomy and other branches of knowledge such as computer science. In the worst cases, CALL is seen as little more than a tool mimicking a textbook, a learner's peer or a teacher.

Besides, other researchers also proposed their opinions about CALL. According to Ken (2003), "A definition of CALL that accommodates its changing nature is any process in which a learner uses a computer and, as a result, improves his or her language" (p.7).

---

\* Tel.: 080-4440-8807;  
E-mail address: [scjxy8807@yahoo.co.jp](mailto:scjxy8807@yahoo.co.jp)



Moreover, CALL means “ learners learning language in any context with, through, and around computer technologies ” (see Joy L. Egbert 2008:4). Additionally, CALL is defined as “ the search for and study of applications of the computer in language teaching and learning ” (Levy 1997:1).

CALL programs about drill and testing have appeared since 1950s in the United States. It has developed over 50 years and the development can be categorized in terms of three distinct steps: behavioristic CALL, communicative CALL, and integrative CALL (Warschauer & Healey, 1998). CALL did not appear in China until 1980s. Although the history of CALL is brief in China, it has developed quickly in the past 30 years since there has been a large demand for the flexible modle. The development of CALL can be roughly classified into three stages in China (Cao Chao, 2009): audio-visual stage (1979-1993), computer-aided stage (1994-1999), and integration of multimedia network stage (2000-2008).

## **2 Literature review**

Researchers in China have explored the development of CALL in the past few years. Tan Yanling & Yan Hua (2007) presented an overview of CALL in China based on papers published in the ten influential foreign language journals from 1997 to 2006 and made conclusions about features and tendencies of CALL in China.

Na Min (2008) also gave a statistical analysis and literature review about CALL in China based on papers published in 8 major linguistics journals in the past 12 years (1995-2006) and finally the future development trend of CALL was predicted.

Cao Chao (2009) also concluded the development of CALL in the past 30 years since the reform and opening-up of China.

Liu Hong & Zhao Miaomiao (2012) investigated and analyzed the hot spots of CALL in China with the keywords frequency analysis based on papers published in journals from 2008 to 2011 at home and abroad.

In addition, Yang Chunhong (2014) also analyzed the bibliometric characteristics of the papers based on CAFLE (Computer-assisted Foreign Language Education) from 2009 to 2013 and found out both the characteristics and developing rules of CALL in China.

Furthermore, Zheng Chunping (2015) has examined research trends of CALL based on articles published by 5 international CALL journals from 2010 to 2014 with word frequency analysis method and found out that there were eight research hot topics in the field of CALL.

Based on the above studies of CALL in China, this paper attempts to analyze the development trend of CALL in China by researching 120 articles from CNKI (China National Knowledge Infrastructure) from 2010 to 2016.

## **3 Data collection and methodology**

This paper adopts both quantitative and qualitative studies of CALL in China, aiming at investigating the development tendency of CALL in China. All the data are selected based on CNKI focusing on papers from 2010 to 2016.

Figure 1. Total numbers of papers from 1985 to 2016

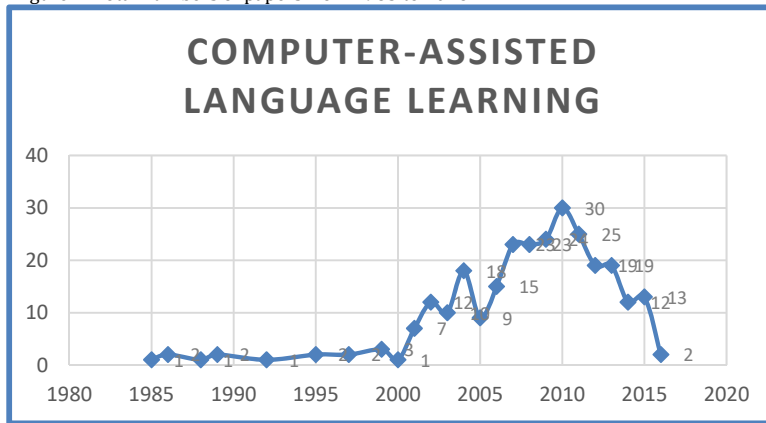

Table 1. Total numbers of papers

Year	2016	2015	2014	2013	2012	2011	2010	2009	2008	2007	2006	2005
Number	2	13	12	19	19	25	30	24	23	23	15	9

2004	2003	2002	2001	2000	1999	1997	1995	1992	1989	1988	1986	1985	Total
18	10	12	7	1	3	2	2	1	2	1	2	1	276

Firstly, “call” was considered as the key word to be searched based on CNKI. And numbers of papers published in journals are 276 in total from 1985 to 2016. It is obvious that the number of papers increases gradually from 1985 to 2000. Furthermore, it increases rapidly from 2000 to 2010 and the number of papers in 2010 reaches 30, the most in recent years. However, it declines steeply from 2010 to 2016.

In addition to this, computer has been widespread in China since the late 1990s. According to Sun Fenglan & Hu Jiasheng (2014), carrying out College English Teaching Reform by utilizing computer technology has been advocated in China since 1999 (p.53). Moreover, in 2001, Ministry of Education of the People’s Republic of China stated that teaching method must be adjusted to the standard of the technological development aiming at cultivating talents. Also, universities should strengthen the construction of digitalization of educational resources, such as campus network, electronic libraries, and multimedia etc for college teachers and students to utilize information technology. As for the compulsory courses regulated by national key universities, class hours by using multimedia should occupy more than 30%. In contrast, other universities should take up more than 15%. Therefore, it is clear that 2000 is the turning point of the development of CALL in China. With the popularity of computer technology and the connection between computer and education, researches on CALL have increased rapidly since 2000.

This paper mainly focuses on 120 papers published from 2010 to 2016, aiming at analyzing the research hot spots about CALL in recent China, exploring the development

trend of CALL in China and making suggestions based on problems of CALL. Furthermore, the actual number of papers from 2010 to 2016 is 117 except two papers about conferences and one repetitive paper.

## 4 Data analysis

### 4.1 Research content analysis

In order to find out the hot spots about CALL in recent years, the author collected and classified all the key words based on 117 papers making use of the excel table.

Table 2. Keywords based on papers from 2010 to 2016

Number	Keywords	2010	2011	2012	2013	2014	2015	2016	Total
1	CALL	20	14	14	10	5	14	2	79
2	pronunciation	1	4	2	5	2	2	0	16
3	College English	3	5	1	1	2	0	0	12
4	autonomy	4	2	1	0	1	2	1	11
5	mandarin proficiency test	1	2	2	2	0	0	0	7
6	theory	3	2	2	0	0	0	0	7
7	English listening	2	1	1	0	1	1	0	6
8	MALL	0	0	0	3	2	0	0	5
9	tone evaluation	0	0	0	1	0	3	0	4
10	learning strategy	0	0	0	0	3	1	0	4
11	teachers' roles	4	0	0	0	0	0	0	4

Apparently, "CALL" is the top keyword. Besides, researches about "pronunciation" mainly focus on "mispronunciation detection" which reaches the most in 2013 and declines in recent years. It is clear that "college English" is also one of the hot spots; however, the number of it has begun to decline since 2012. Furthermore, researches about "autonomous learning" develop not so well based on above numbers. Moreover, the author found out that researchers have gradually come to do some researches on "MALL (Mobile Assisted Language Learning)", "tone evaluation", and "learning strategy" since 2013. While, topics about "theory" of CALL and "teachers' role" decline in recent years. Additionally, the author also found out that researches about "English listening" are much more than "writing", "speaking" or "vocabulary".

Based on the collected papers, we can also find out that researches on CALL in China

are widespread, such as researches on the relations between second language acquisition and CALL, college English interactive teaching mode, problems and strategies about CALL in China, summary of literature review about CALL at home and abroad, students' attitude toward CALL, and strategies about teaching and learning. In addition, synchronous video-based interaction and collaborative teaching have been introduced, which has provided an authentic cross-national environment for language learners.

#### 4.2 Research methodology analysis

The author classified the research methodology based on 117 papers and found out that there are totally 20 empirical studies about CALL.

Table 3. Empirical study from 2010 to 2016

Author	Research period	Level Subjects	Methodology	Findings
Qian Yubin (2016)	9 weeks	31 postgraduates (non-English majors)	Interview Test	1Learners' vocabulary knowledge in spelling, meaning, and usage has been greatly improved. 2 Learners could manage their learning process more actively.
Zheng Chunping, Lu Zhihong & Lian Jingjing (2016)		21 Chinese learners from Dartmouth College	Questionnaire Interview	The result indicated that this program is beneficial for learners to improve their language performance.
He Bi, Liu Lei & Chen Ting (2015)	18 weeks	Freshmen of English majors	Questionnaire Test	1 Results revealed that students' pronunciation level has been improved. 2 Autonomous learning of the students also has been greatly improved under the CALL Verbo-tonal system.
Yan Xiu & Wang Honghua (2015)		270 college students from Hong Kong	Questionnaire Grades of the Chinese course	1 It was found that the usage of software, Putonghua learning motivation, and course grades were correlated with each other. 2 Putonghua learning motivation consisted of "liking of Putonghua learning" and "effort in putonghua learning".
Wang Mengmeng & Zhang Hai (2015)		601 fourth year undergraduate students majoring in Spanish	Questionnaire	1 The result indicated that metacognitive strategies play an important role in learning strategies. 2 It also indicated that the application of statistical software of CALL is considered as the catalyst during the development of language education.
Cao Wen, Hu Zengning, Li Hui & Xu Xin (2015)	3 years	1 Primary English teachers and middle school English teachers who attended the training courses in Beijing 2. 42 teachers from Guangdong,	Literature review Questionnaire Case study Seminar Interview Recording	It explored the current situation of computer-based teaching mode applied in primary school and middle school English courses.

		Shandong, and Beijing 3. 17 teachers including 9 primary teachers, 3 junior middle school teachers, and 5 senior middle school teachers		
Zhao Yebing (2014)		50 undergraduate English majors from Sun Yat-sen University	Questionnaire	The result revealed the relation between English level and CALL strategies. Meanwhile, it found out that students who are good at English could get high grades in CALL learning strategies test and they spend more time in web-based English learning.
Feng Yong & Wang Xin (2014)		Non-English majors from Inner Mongolia University of Technology	Questionnaire	The author found out some problems in college English teaching and learning under CALL, such as due to lack of computers, or limitation of the internet, students couldn't learn English autonomously.
Liu Liyi (2013)	1 term	130 sophomores and 10 college teachers	Questionnaire	The result discovered that students' attitude toward CALL is complicated and they expect more interesting and useful material under CALL language learning.
Yang Xianjian (2013)		English majors and non-English majors	Questionnaire	1 The results revealed that students' attitude toward CALL applied in English reading are positive. 2 It also revealed that the frequency of using computers by teachers has little influence on students' attitude toward CALL.
Li MengDuan (2013)		College English teachers from one of the universities in Hainan	Questionnaire	The author found out some problems in this survey and proposed some suggestions. The survey revealed that teachers are not familiar with CALL, such as some of them do not know what CALL is. The author suggested teachers should change their attitude toward CALL.
Jiao yanwei (2013)		4 postgraduate English-majors	Test	The experiment told us that the four students are not majoring in linguistics, but they could spend about 1 hour searching information on linguistics through Wikipedia. It revealed that Wikipedia is important and practical in English learning.
Qu Keting (2012)		200 sophomores	Questionnaire	The result told us that it can reduce students' anxiety through CALL, because they could raise students' interest and motivation in learning English.

Dong Shiwen (2012)		83 English majors and 173 non-English majors	Questionnaire	It revealed that CALL is beneficial for interpreter training, because it can help improve interpreters' note-taking skills; however, some limitations have been pointed out, such as the lack of supervision etc.
Chen Feng (2011)		120 students and 30 teachers	Questionnaire	Both teachers and students hold positive attitude toward CALL, though they propose limitations of CALL, such as lack of high-quality courseware.
Huang Haiquan (2010)		20 English teachers and 200 freshmen	Questionnaire	The author explored problems in CALL, such as some students are addicted in computer games during study in language center and proposed some suggestions.
Liu Fengxiang (2010)		125 freshmen of non-English majors	Questionnaire Interview	It concluded that CALL can inspire students' learning motivation and autonomy in English learning.
Shi Huiping & Gao yali (2010)		45 college English teachers from Jiangnan University	Questionnaire Interview	The author found that teachers hold positive attitude toward CALL and the subjects integrate CALL with English teaching frequently.
Liu Yang (2010)	1 week	Two classes and 60 postgraduates from Xi'an Jiaotong University	Class observation Questionnaire	The result showed that Teachers play a key role in CALL and they should improve teaching quality by adopting various teaching methods.
Yang Qi (2010)		500 sophomores from Heze University in Shandong Province	Questionnaire Interview	This paper discussed autonomous learning ability in English based on college students from Shandong Province and found out that most of the students lack study plan, the application of study strategies, and self-assessment. Besides, the author also talked about the necessity of autonomous learning under CALL, and pointed out some issues which should be taken seriously.

Based on Table 3, we can understand that most of the empirical studies are finished in a short time, among which only one study lasts 3 years. In addition to this, there are 18 papers adopting questionnaire to do the research, which occupies 90% of the empirical study. Other research methods are necessary for further studies. Taking the subjects into account, it seems that the research level is mainly focused on colleges including English majors, non-English majors, and postgraduates. Only one paper is about primary school, junior middle school and senior middle school, which shows that large-scale studies about CALL have not started in primary school, junior middle school and senior middle school. Moreover, we can see from the conclusions that although theoretical studies account for a large proportion of the 117 papers, empirical studies are gradually increasing recently.

Apparently, it can be concluded on the basis of the research findings that CALL is beneficial for language teaching and learning and also some problems under CALL have been found out by researches. Some researchers have made conclusions about advantages under CALL, such as students' vocabulary level, pronunciation level, and autonomous learning have been improved; teachers' and students' attitude toward CALL is positive, which could help raise students' interest and motivation in language learning. Meanwhile, it can reduce students' anxiety. Also, CALL is beneficial for interpreter training. As for the problems of CALL, it can be roughly divided into three types:

- Facility: Due to lack of computers or limitation of the internet, students could not learn English autonomously.
- Teachers: Teachers are not familiar with CALL and some of them do not know what CALL is.
- Students: Some students are addicted in computer games during study in language center.

Besides, some researchers also pointed out that CALL is beneficial for language learning, but there existed some problems by CALL for lack of supervision for interpreter training and high-quality courseware.

Table 4. Theoretical study & empirical study based on papers from 2010 to 2016

	2010	2011	2012	2013	2014	2015	2016	Total number	Percentage
Theoretical Study	25	22	17	15	9	9	0	97	82.9 %
Empirical Study	5	1	2	4	2	4	2	20	17.1 %

Figure 2. The development trend of theoretical study

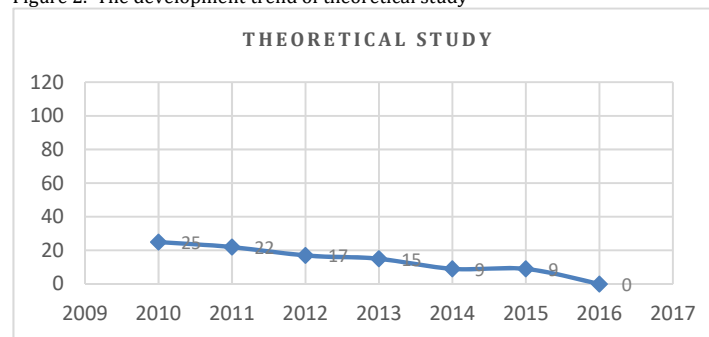
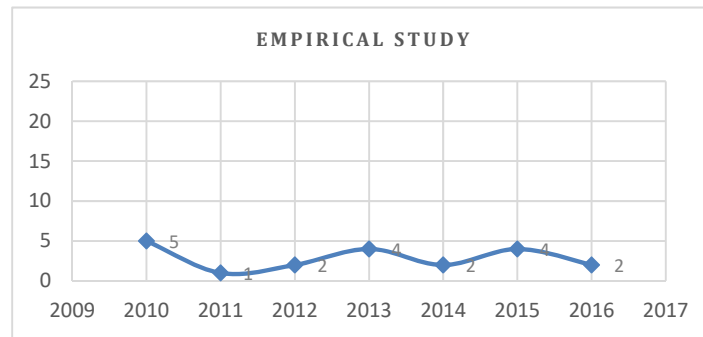

Figure 3. The development trend of empirical study



Clearly, we can see from Table 4 that theoretical study accounts for 82.9% of the 117 papers, which is much more than empirical study in recent years; however, empirical study only makes up 17.1% of the 117 papers. Figure 2 presents the development trend of theoretical study and Figure 3 presents the development trend of empirical study. From Figure 2 and Figure 3, we know that theoretical study about CALL declines from 2010 to 2016. In contrast, empirical study is gradually increasing with the development of CALL in China.

## 5 Conclusion

It can be concluded that research contents are mainly focused on college English, autonomous learning, and MALL (Mobile Assisted Language Learning) etc. Also, the research level is still concentrated on college students and teachers. Furthermore, English is popular under CALL by researchers in China. Chinese and even German are gradually emphasized in recent years.

Additionally, Table 3 tells us that most of the empirical study has been done within a short period and 90% of the empirical studies adopt questionnaire to do the research. Besides, most of the empirical studies are focused on advantages and disadvantages of CALL in China. From the perspective of research methodology, we can also see that theoretical study is far more than empirical study on the basis of Table 4. However, in Figure 2 and Figure 3, we know that theoretical study declines gradually in recent years. In contrast, the number of empirical study increases in recent years.

Some problems have been found out during analysis. Firstly, there are some problems during classification of the key words, because most of the papers are finished in Chinese and some papers do not contain English abstracts or key words. Also, some papers do not contain abstracts or even key words.

Secondly, studies on CALL are mainly focused on English. With the development of teaching Chinese as a foreign language, Putonghua Shuiping Ceshi (mandarin test) has been widely spread, among which studies on pronunciation detection of mandarin has been improved under CALL; however, other languages have not been studied extensively and only a few papers made introductions about German and Spanish under CALL.

Thirdly, research level are mainly concentrated on college teachers or students, including English majors and non-English majors. While, studies on postgraduates have been increased in recent years. In contrast, studies on primary school and junior middle school and senior middle school have not been analyzed deeply.

Considering the above problems, some suggestions have been made. From the



perspective of contents, studies should not only focus on theory, characteristics, or problems about CALL in China and further systematic studies are necessary for the development of CALL in China. As for the research method, empirical study should be emphasized for the future study. It should be noticed that this paper has limitations. Firstly, this paper explored the development trend of CALL in China based on CNKI. For the future study, other databases, such as databases in Japan, are necessary. Secondly, the study period should not be limited within 2016. The author should continue investigating the development trend of CALL in the future.

## References

- Beatty.(2003).Teaching and Researching Computer-assisted Language Learning. Candlin et al.(Ed.). p.1,2,7. London, New York, Toronto, Sydney, Tokyo, Singapore, Hong Kong, Cape Town Madrid, Paris, Amsterdam, Munich, Milan, Pearson Education.
- Cao.(2009).30 Years of Computer-Assisted Language Learning in China: Retrospect and Prospect. J.Foreign Languages and Their Teaching. Serial No.245, No.8, pp.39-42.
- Egbert et al.(Ed.).(2008).CALL Research Perspectives.Egbert(Ed.). Conducting Research on ALL.p.4.New York,Routledge.
- Levy, M.(1997).CALL: context and conceptualization. Oxford: Oxford University Press.
- Liu et al.(2012).Research on Hot Spots of Computer Assisted Language Learning between China and Overseas Based on Keyword Frequency analysis. J.Overseas Chinese Education. pp.352-360.
- Na.(2008).Duomeiti Jisuanji Jishu Yu Waiyu Kecheng De Zhenghe Yanjiu-Dui Woguo Duomeiti Fuzhu Waiyu Jiaoxue Yanjiu Zhuangkuang De Tongji Fenxi (Integrated Study Between CALL and Foreign Language Courseware-Statistical Analysis on the Research of CALL in China)(in Chinese). J.Foreign language World, General Serial, No.124, No.1, pp.52-63.
- Na.(2012).Jin Shinian Woguo Duomeiti Fuzhu Waiyu Jiaoxue Shizheng Yanjiu Wenxian Pingxi.(A Bibliometric Analysis on the Empirical Study of CALL in Recent China Based on 10 Years)(in Chinese). J.Journal of Inner Mongolia Normal University (Educational Science). Vol.25, No.7, pp.112-116.
- Sun et al.(2014).Domestic and Foreign CALL Research Overview and Its Disciplinary Development Trend.J. XDIYIS Vol.24, No.6, pp.50-57.
- Tan et al.(2007).CALL Research Over 10 Years: Retrospective and Prospective Analyses. J.Computer-assisted Foreign Language Education. No.117, pp.37-42.
- Warschauer, M. et al.(1998).Computers and language learning: An overview. Language Teaching, p.31, 57-71.
- Yang et al.(2014).A Bibliometric Analysis on the Study of Computer-assisted Language Learning in China-Based on the Published Papers in computer-assisted Foreign Language Education from 2009 to 2013. J.College English Teaching & research. Serial No.71, No.4, pp.82-88.
- Zheng et al.(2015).International Research Trends in Computer-Assisted Language Learning-Keyword Analysis of CALL Journal Articles from 2010 to 2014. J.XDIYIS. Vol.25, No.7, pp.75-81.
- Zhang et al.(2015).Duomeiti Huanjingxia Woguo Waiyu Jiaoxue Yanjiu Zhuangkuang De Tongji Fenxi Yu Fansi(Statistical Analysis on CALL in China)(in Chinese). J.Education Teaching Forum. No.32, pp.185-186.

Topic : Humanities

## **Causative and adhortative expressions in Medieval English**

Kousuke Kaita

*Graduate School of Humanities and Social Sciences, Chiba University,  
1-33 Yayoicho, Inageku, Chiba, 263-8522, Japan*

---

### **Abstract**

In Modern English (MnE, dating 1500 onwards), causative and adhortative expressions are represented by *LET* and *MAKE*: (1) *He let her go* (meaning 'he permitted her to go'); (2) *He made her go* ('he forced her to go'); and (3) *Let's go*. In the history of English language, there are several other lexemes used for these notions. For causative expressions, Old English (OE, dating 700-1100) attested *HĀTAN* 'to command' and *DO* besides *LET*, while *MAKE* came into use since the Middle English (ME) period (1100-1500). Before the rise of *LET* (with *US*) for the adhortative usage in ME, OE had another auxiliary *UTON* (sometimes followed by *WE*) placed at the initial position of a declarative sentence. Prior research has focused on the use of these auxiliaries individually, and their systematic alternation is suitable for comprehensive discussion. This paper examines how causative and adhortative expressions were interrelated in OE and ME. Were there semantic differences among *LET*, *HĀTAN*, *DO*, and *MAKE* as in MnE examples (1) and (2)? Why was *UTON* (*WE*) replaced by *LET* (*US*) for the adhortative case as in (3)? This paper will provide the following insights. For causative auxiliaries, OE *LET* is chiefly used in the permissive sense while *HĀTAN*, *DO*, and *MAKE* convey an obligative sense. In the lexical alternation of the adhortative, *UTON* falls into disuse along with the decline of the word order, with its finite verb in the initial position, and *LET* in the imperative mood takes over the adhortative function.

### **Keywords**

Medieval English; causative; adhortative; *LET*; auxiliary

---

## **1. Introduction<sup>1</sup>**

In English, the word *LET* is used to express both the causative notion, as in *He let her go*, and the adhortative notion, as in *Let's go*.<sup>2</sup> This research project originated in the question of why these different expressions share the same auxiliary *LET*. Quirk et al. (1985: 1205) assign to *LET* in the former use (and the other causatives *MAKE* and *HAVE*) the interpretation "verbs of coercive meaning". For the latter use, *Let's* is derived from *Let us*. For this reason, Huddleston & Pullum (2005: 170) define *Let's* as the "1ST

---

<sup>1</sup> This investigation is based on a paper read at the 19th International Conference on English Historical Linguistics (ICEHL) held at University of Duisburg-Essen, Germany, on 24 August 2016.

<sup>2</sup> 'Causative' here refers to the situation that someone has another person do something. 'Adhortative' is a term used when an addresser proposes to the addressee to do something together.

PERSON IMPERATIVE *LET*". The present investigation focuses on the development of causative and adhortative expressions in the history of English, namely in Old English (English dating about 700-1100) (henceforth abbreviated as OE), Middle English (1100-1500) (ME), and Modern English (1500-) (MnE). The primary focus is on the Medieval English period, which includes OE and ME.

## 2. Framework: method and material

### 2.1. Modality in causative and adhortative expressions

Both the causative and adhortative notions are considered closely related to modality. Curme (1931: 432) regards *LET* as a modal auxiliary. Krug (2009) categorises the adhortative sentence as a type of modality expression. According to Aarts (2011: 275), modality can be defined as:

a concept which is concerned with such semantic notions as 'possibility', 'probability', 'necessity', 'obligation', 'permission', 'intention', and 'ability'

Modality usually refers to the class of meanings expressed by the modal auxiliaries, such as *may* (expressing permission), *should* (obligation), and *will* (intention). Causative and adhortative expressions can also be associated with the following three notions. A causative sentence *He let her go*, meaning 'He permitted her to go', carries the modal notion of PERMISSION. A coercive sentence *He made her go*, meaning 'He obliged her to go', alludes to the reading of OBLIGATION, and the adhortative *Let's go* expresses the speaker's wish to go together with the hearer, and thus it is appropriate to admit the modality of VOLITION (cf. Krug 2009).<sup>3</sup>

### 2.2. Lexical alternation

At the lexical level, there have been several words that have been used historically as causative and adhortative auxiliaries. Among these, the following five auxiliaries will be dealt with in the present investigation: (i) *MAKE* (OE *macian*; ME *maken*); (ii) *DO* (OE *dōn*; ME *don*); (iii) *HĀTAN* (OE *hātan*; ME *hōten*); (iv) *LET* (OE *lātan*; ME *lēten*); (v) *UTON* (OE *uton*; ME *ute*).

According to Royster (1922), the first four (OE *macian*, *dōn*, *hātan*, and *lātan*) are used for periphrastic causative constructions. The causative notion (as in MnE *he let her go*) was expressed by OE *LET* (see *OED2*, s.v. *let*, 12.a.; Traugott 1995; Krug 2009; Nykiel 2010; Lowrey 2013), while OE *HĀTAN* 'to command (someone to do something)' (see *OED2*, s.v. †*hight*, 1.; Nagucka 1979; Ikegami 1981; Nykiel 2010; Lowrey 2013) and *DO* (see *OED2*, s.v. *do*, 22.a.; Ellegård 1953; Ikegami 1981) and ME *MAKE* (see *OED2*, s.v. *make*, 53.a.; Terasawa 1985) were also prevalent in Medieval English. *UTON* is an obsolete adhortative auxiliary used in OE and ME that derived from the 1st person plural subjunctive present form of the motion verb *gewītan* 'to go', and was supplanted by *LET* in ME (see *OED2*, s.v. *let* 14.a.; †*ute*; Warner 1993; Traugott 1995; Ogura 2000/2002; Krug 2009; van Bergen 2013). Like MnE *Let's*, *UTON* was used in the initial position of a declarative sentence followed by a bare infinitive. The historical alternations of these lexemes is illustrated in the following figure.

---

<sup>3</sup> These three notions almost correspond to what Palmer (2003: 7) terms deontic and dynamic modality (Palmer's examples: *They may/can come in now* and *They must come in now* for deontic modality and *I will help you* for dynamic modality). For various other classifications of the modality of modal auxiliaries, see Kaita (2015: 20-34).

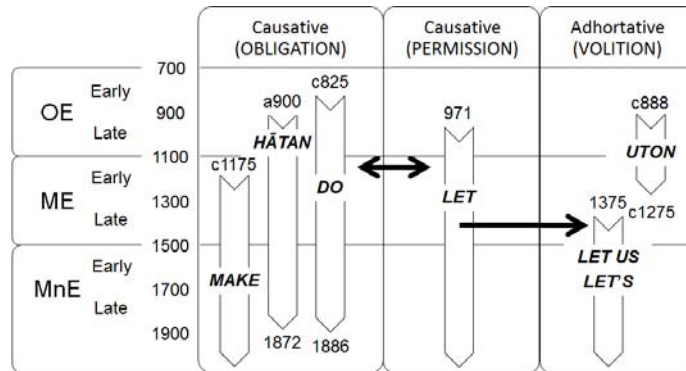

Figure 1. Chronology (based on the datings of the OED2)

Initially, in the causative category for OBLIGATION, *HĀTAN* and *DO* were used, but they eventually died out as causative auxiliaries. From ME onwards, *MAKE* came to be used as an auxiliary. For PERMISSION, *LET* has been predominant since OE. In ME, *LET* was also used for the adhortative notion expressing VOLITION from the 14th century on, after *UTON* became obsolete in the 13th century.

### 2.3. Research question and hypothesis

As mentioned above, several studies have been conducted on these five verbs individually. Their systematic alternations appear to await a comprehensive discussion of how the causative and adhortative expressions were interrelated in OE and ME. In particular, the following two points should be considered. First, for the causative, whether it is possible to detect a sense of OBLIGATION in *LET*, in addition to *MAKE*, *DO*, and *HĀTAN*. Second, for the adhortative, why *UTON* disappeared and *LET* emerged.

These two points can be hypothesised as follows. Causative *LET* mainly denotes PERMISSION, while the reading of OBLIGATION depends on the context. In the history of the adhortative, *UTON* was lost in accordance with the general tendency to lose the word order of a finite verb preceding its subject in declarative sentences. Instead, *LET* came into use because there was a need to clarify VOLITION and PERMISSION. People in the Medieval English period needed to convey that certain actions were being carried out of their own volition and others by permission of an authority like God or a king. I shall verify these hypotheses in the subsequent sections based on readings of several OE and ME primary texts.

### 2.4. Corpora

In the present study, religious texts play a central role. Their contents are rich in situations where the narrators wish to relate what is permitted and commanded by God or Christ and to exhort the audience to carry out acts that are in accordance with God's doctrines. The primary texts examined are the following homiletic texts in OE: *The Blickling Homilies* (Morris (ed.) 1874-1880), *Ælfric's Catholic Homilies* (Thorpe (ed.) 1844-1846; Godden (ed.) 1979; Clemons (ed.) 1997), *Ælfric's Lives of Saints* (Skeat (ed.) 1881-1900), and *Lives of Saints* not by Ælfric, which are Skeat's homily numbers 23 (*LS* 34 (SevenSleepers)<sup>4</sup>), 23B (*LS* 23 (MaryofEgypt)), 30 (*LS* 8 (Eust)), and 33 (*LS* 7 (Euphr)) (see Clemons 1959: 219 and Magennis 1986). For Early ME the text selection is small. It covers *Lambeth Homilies* (Morris (ed.) 1868) and *Trinity Homilies* (Morris (ed.) 1873).

<sup>4</sup> The short titles of the texts in OE are based on the abbreviations used in *The Dictionary of Old English, Web Corpus* (DOEWC).

### 3. Causative

In this section, it will be demonstrated that *LET* is used primarily for PERMISSION, and the tone of OBLIGATION is an additional interpretation, sometimes dependent on the context. One typical example is (1), which the *OED2* (s.v. *let*, 12.a.) takes as its first example. In this case the subject that permits the audience (*þe* 'you') is the Lord. The permission from the Lord here, contextually, can be interpreted as something forced as well as permitted.

(1) OE: *HomS* 14 (BIHom 4) 204<sup>5</sup>

hwæt dest þu þe, gif Drihten on þe genimþ þa nigan dælas,  
what do you for-you if Lord from you takes the nine parts  
& þe læteþ þone teoþan dæl anne habban?  
and you lets the tenth part only have  
“what wilt thou do if the Lord taketh from thee nine parts of thy wealth, and letteth thee have only the tenth part?” (translation by Morris (ed.) 1874-1880: 50)

This ambiguity of *LET* can be illustrated more concretely by the following two examples, (2) and (3), which are based on Matthew 5.45 (see Cook 1898: 146-147<sup>6</sup>). Concerning the example (2) below, Lowrey (2013: 35) finds ambiguity in the interpretation of *LET*.

(2) OE: *ÆCHom* I, 28 413.97

Se mildheorta drihten þe læt scinan his sunnan ofer þa rihtwisan. &  
the merciful Lord who lets shine his sun over the righteous and  
unrihtwisan gelice. & sent renas. & eorþlice wæstmas godum &  
unrighteous alike and sends rains and earthly fruits to-the-good and  
yfelum  
to-the-evil  
“The merciful Lord, who lets/makes his sun shine over the righteous and  
unrighteous alike, and sends rains and earthly fruits to the good and evil”  
(translation by Lowrey 2013: 35)

The auxiliary *læt* in (2), although literally meaning ‘lets’, appears to bear the coercive reading ‘makes’. Lowrey (2013) reads *LET* here as either “lets” or “makes”. The subject is once again the Lord and His permission is understood as an obligation placed on the object (the sun) from the perspective of the narrator. This coercive reading is somewhat clearer in (3), which has a similar context to (2) but uses *DO* instead of *LET*.

(3) OE: *ÆCHom* II, 12.2 123.446

And gebiddað for eowerum ehterum. and eow tynendum. þæt ge beon  
and pray for your persecutors and you injurers that you are  
eoweres fæder bearn. se ðe on heofonum is. se ðe deð his sunnan scinan  
of-your father child who in heaven is who makes his sun shine  
ofer ða yfelan. and ofer ða godan. and sylð renscuras ðam  
over the evil and over the good and gives rain-showers to-the  
rihtwisum. and ðam unrihtwisum  
righteous and to-the unrighteous

<sup>5</sup> The texts in the OE examples in the citations (1)-(4) and (6) are from *DOEWC*. Literal glossing and emphasis are mine.

<sup>6</sup> The corresponding Latin text given by Cook (p. 146) reads: *orate pro persequentibus et calumniantibus vos, ut sitis filii Patris vestri qui in coelis est, qui solem suum oriri facit super bonos et malos, et pluit super iustos et iniustos*, where *facit* (3rd person singular present form of *facere* ‘to do’) corresponds to *læt* in (2) and *deð* in (3).

“and pray for your persecutors and injurers, that ye be children of your Father who is in heaven, who maketh his sun to shine over the evil and over the good, and giveth rain-showers to the righteous and to the unrighteous” (translation by Thorpe (ed.) 1846: 217)

A closer look at the manuscript variants in the Medieval English may help to determine the coercive meaning of *LET*. The following example (4) exhibits the manuscript variants between *LET* and *HĀTAN*. *LET* in this context is replaced by *HĀTAN* in two later manuscripts (see Clemons (ed.) 1997: 335): manuscript P (Oxford, Bodleian Library, Hatton 115 (Ker 332, s. xi<sup>2</sup>)) and manuscript B (Oxford, Bodleian Library, Bodley 343 (Ker 310, s. xii<sup>2</sup>)). The use of *HĀTAN* in both manuscripts clarifies the coercive reading of the context.

(4) OE: *ÆCHom* I, 20 335.14

Mannum he sealde uprihtne gang: þa nytenu he let gan alotene  
 to-men he gave upright going the cattle he let go bowed-down  
 “To men he [= God] gave an upright gait; the cattle he let go bending downwards”  
 (translation by Thorpe (ed.) 1844: 277)

Lowrey (2013: 35) discusses the lexical conflict between *LET* and *HĀTAN*: “[i]t is the spread of causative *læt*, apparently, that spells the end for causative *hatan*”. While it is true that *LET* is used in a wide range of contexts, the coercive interpretation of *LET* is rather unstable in the OE period. Indeed, there are cases such as (4) that demonstrate the lexical replacement of *LET* with *HĀTAN*. Therefore, there appears to be a need to compare the uses of *HĀTAN*, *LET* and even *DO* in a more concrete and comprehensive fashion.

Later in ME, *MAKE* emerges as another causative auxiliary. Example (5) from the *Lambeth Homilies* is regarded by the *OED2* as the first attestation of *MAKE* (s.v. 53.a.).

(5) ME: *Lambeth Homilies* 17.159.17-19<sup>7</sup>

Pe ter þet .Mon. wepð for longinge to heouene; is inemned deu water  
 the tear that man weeps for longing for heaven is called dew water  
 for alswa se þe sunne drach up þene deu. and makeð þer of kume  
 for as the sun draws up the dew and makes thereof come  
reines; swa makeð þe halie gast þe .Mon. bi-halden up to houene  
 rains so makes the Holy Ghost the man look up to heaven  
 “The tear that a man weepeth through longing for heaven is called dew-water, for as the sun draweth up the dew and maketh thereof the rains to come, so the Holy Ghost maketh the man to look up to heaven” (translation by Morris (ed.) 1868: 158)

In (5), the causers of the rains are the sun and the Holy Ghost. The former is inanimate. It nonetheless seems possible, however, to read the agentivity of the sun in this example. The sun can be regarded as the carrier of the wish to cause the event, taking into account that a correlative conjunction *alswa* ‘just as’ with *swa* ‘so’ connects the sun and the Holy Ghost. Terasawa (1985: 135) does not regard the above example (5) as conveying the “coercive” meaning (“to force a person to do something by an exercise of influence, authority, or violence”), but instead argues that this meaning can be found from the 16th century, based on the examples in the *OED* (s.v. *make*, 54.).<sup>8</sup> It further remains to be seen whether such a coercive reading is possible as early as the Medieval English period.

<sup>7</sup> Text from Morris (ed.) (1868: 159). Literal glossing and emphasis are mine.

<sup>8</sup> The definition of the *OED2* (s.v. *make*, 54.a.) is: “[t]o constrain (a person) to do something, by an exercise of influence, authority, or actual or threatened violence”.

## 4. Adhortative

In English, there has been no exclusive form used to express the adhortative meaning. Bauer's (2004) glossary of morphology (s.v. *mood*) lists "hortative" as a mood which "shows exhortation", and classifies it with imperative, indicative, and subjunctive moods as "[s]ome typical moods" in language. Verbs in English conjugate according to the imperative, indicative, and subjunctive moods,<sup>9</sup> but there is no particular morphological category for the hortative. This leads to the question of how the hortative notion can be expressed in English.

### 4.1. *UTON* and modality

There are at least three types of adhortative expressions in OE and ME, as Mustanoja (1960: 475) (cf. Millward 1971: 49) briefly describes:

In OE and early ME, exhortations and commands in the first person plural are expressed by means of the inflectional subjunctive (*helpe we*) or of a periphrasis with *uton* (*ute*) [...]. From later ME on they are expressed by means of a periphrasis with *let* + infinitive

The first form *helpe we* takes the particular inverted word order of the finite verb followed by its subject. Another expression with *UTON* in OE mentioned is frequently found in homilies, sometimes side by side with a modal auxiliary *sculan* (> MnE *shall*, but usually meaning 'must' in OE) as in (6) below.

#### (6) *ÆLS* (Maurice) 119-121

Ac uton þencan georne þonne we þyllic gehyrað, þæt we þe beteran  
but let-us think earnestly when we the-like hear that we the better  
beon, þurh þa boclican lare. We sceolon swincan, and oferswyðan  
be through the bookish lore we have-to toil and overcome  
unþeawas mid godre drohtnunga Godes rice gearnian  
evil-habits with good service God's kingdom earn  
"But let us think earnestly, when we hear the like, that we may be the better by  
means of bookish lore. We have to toil, and overcome evil habits by a good service,  
to earn God's kingdom" (translation by Skeat (ed.) 1900: 165)

The combination of *UTON* and the modal *sculan* with the 1st person subject explicates the exhortative notion as typifying the purpose of the homily. The homilist expresses his intention to act properly together with the audience, and he believes that doing such things is an obligation.<sup>10</sup> Van Bergen (2013: 170) convincingly points to the collocation of *UTON* and a modal *sculan* meaning 'must':

[t]he modal *sceal* 'must' may be used to express commands, instructions, and exhortations as well, and it can occur in contexts similar or identical to those in which *uton* constructions are found

This analysis is conducive to accepting that both modal auxiliaries and the adhortative auxiliary belong to the semantic realm of modality.

<sup>9</sup> Note, however, that there are some morphological ambiguities of the verb forms within these three mood categories. Take the OE verb *bindan* 'to bind', for example: *binde* can be the 1st person singular indicative present form ('I bind') or a subjunctive present form in all three persons. Another form *bindaþ* can be the plural indicative present form ('we/you/they bind') or the imperative plural form ('bind').

<sup>10</sup> Note also that *sculan* with the 1st person subject may express intention with a meaning close to 'will' (OE *willan*). This is pointed out by Standop (1957: 123): "[s]*culan* scheint sich vor allem in der 1. Pers. oft der Bedeutung von *willan* zu nähern" (*sculan* especially in the first person appears often to approach the meaning of *willan*) (my translation).

#### 4.2. Loss of *UTON* and the rise of *LET*

As sketched in Section 2.2., in the adhortative category OE *UTON* fell into disuse and *LET* came into use in the Medieval period. The demise of *UTON* can be ascribed to the decline of so-called verb-first (V1) order in declarative sentences, where the finite verb is placed at the beginning of the sentence preceding its subject.<sup>1 1</sup> *UTON* almost always appears in the V1 position, followed by its subject *we*. This order does not follow the general tendency of word order change, as Öttenfors (1997: 242) briefly mentions:

[d]ie noch im Ae. häufige V1-Stellung im selbständigen DS [= Deklarativsatz] wird im Laufe der Zeit etwas seltener, wenn sie auch im Me. nicht verschwindet

'The V1 order in the declarative sentence, still frequent in OE, becomes somewhat rarer in the course of time, although it does not entirely disappear even in ME' (my translation)

The construction using *LET* with *US* is attested later. The following (7) is the first example of *LET US* in the *OED2* (s.v. *let*, 14.a.).<sup>1 2</sup>

(7) ME: Chaucer *Canterbury Tales*, *The Man of Law's Tale* 953-954<sup>1 3</sup>

Now lat us stynte of Custance but a throwe,  
now let us cease-speaking of Custance only a space-of-time  
And speke we of the Romayn Emperour  
and speak we of the Roman Emperour

'Let us cease speaking of Custance for just a short time and let us speak of the Roman emperor'

As the V1 word order of the declarative sentence becomes rare in ME, *LET* in the imperative form inherits the adhortative function. The contextual role of this example is to change the topic, and *LET* has two notions: VOLITION and PERMISSION. The narrator in (7) wishes to move on from the story about Custance to the next topic, the Roman emperor, and asks the hearers for permission to change the topic (for the pragmatic interpretation of this example, see Krug 2009: 323-324 in detail). The wish can be conveyed by the imperative form placed in the V1 position, and the permissive notion is in the lexical meaning of *LET*. The use of *LET* in the adhortative context in (7) is possible because *LET* keeps its permissive meaning throughout the ME period.

## 5. Summary

This study investigated the lexical alternations of *LET* and other auxiliaries in OE and ME from the perspective of modality. The main findings can be summarised as follows.

First, OE *LET* mainly denotes PERMISSION. The sense of OBLIGATION is mainly conveyed by OE *HĀTAN* (and occasionally by *DO*) and ME *MAKE*. Second, OE *UTON* clarifies the speaker's wish to carry out the propositional content, but later falls into disuse due to the decline of the declarative V1 order. Third, the rise of ME *LET* in the

<sup>1 1</sup> Many studies discuss the status of this peculiar position of the finite verb. The function of the V1 order may be topicalisation, although I shall not enter into this problem in detail. For this word order in Proto-Indo-European, see Fortson (2010: 159-160), and for that in OE, Ogawa (2000) and Ringe & Taylor (2014: 407-410) are noteworthy.

<sup>1 2</sup> The very first example of 14.a. takes *Lat* with *me*, dated 1375. It seems that the *OED2* makes no clear distinction between the usage for someone's asking permission to do something ('Let me') and an adhortative usage ('Let us').

<sup>1 3</sup> Text from Benson (ed.) (1987: 100). Literal glossing and emphasis are mine.



imperative mood for the adhortative highlights the contextual role of an entity wishing to realise the propositional content, with the permission of the addressee implied.

For further study, the scope of the texts used should be expanded and indispensable theoretical support will be provided through philological analysis of the contexts. This project hopes to contribute to the comprehensive study of several lexemes used for the same or similar functions from a diachronic perspective.

## References

### Dictionaries

*DOEWC* = Healey, A. di., J. P. Wilkin, & X. Xiang, (Eds.). (2009). Dictionary of Old English Web Corpus, Dictionary of Old English Project, Toronto, Canada. <http://www.doe.utoronto.ca/>. Last Accessed 3 November 2016.

*OED2* = Simpson, J. A. & E. S. C. Weiner, (Eds.). (1989). Oxford English Dictionary. 2nd ed. (1st ed. by J. A. H. Murray et al., 1928), 20 Vols. Oxford University Press, Oxford, United Kingdom. CD-ROM Version 4.0 (2009).

### Editions

Benson, L. D., (Ed.). (1987). *The Riverside Chaucer*. 3rd ed., Houghton Mifflin, Boston, USA.

Clemoes, P., (Ed.). (1997). *Ælfric's Catholic Homilies: The First Series*. EETS, s.s. 17, Oxford University Press, Oxford, United Kingdom.

Godden, M., (Ed.). (1979). *Ælfric's Catholic Homilies: The Second Series*. EETS, s.s. 5, Oxford University Press, Oxford, United Kingdom.

Morris, R., (Ed.). (1868). *Old English Homilies and Homiletic Treatises. First Series*. EETS, o.s. 29, 34, Trübner, London, United Kingdom.

-----, (Ed.). (1873). *Old English Homilies of the Twelfth Century. Second Series*. EETS, o.s. 53, Trübner, London, United Kingdom.

-----, (Ed.). (1874-1880). *The Blickling Homilies in the Tenth Century*. EETS, o.s. 58, 63, 73, Trübner, London, United Kingdom.

Skeat, W. W., (Ed.). (1881-1900) [rpt. 1966]. *Ælfric's Lives of Saints*. 2 Vols. (Vol. 1: 1881-1885; Vol. 2: 1890-1900). EETS, o.s. 76, 82, 94, 114, Oxford University Press, Oxford, United Kingdom.

Thorpe, B., (Ed.). (1844-1846). *The Homilies of the Anglo-Saxon Church: The First Part, Containing the Sermones Catholici, or Homilies of Ælfric*. 2 Vols. (Vol. 1: 1844; Vol. 2: 1846), The Ælfric Society, London, United Kingdom.

### Studies

Aarts, B. (2011). *Oxford Modern English Grammar*, Oxford University Press, Oxford, United Kingdom.

Bauer, L. (2004). *A Glossary of Morphology*, Edinburgh University Press, Edinburgh, United Kingdom.

- Bergen, L. v. (2013). Let's Talk about *Uton*. In A. H. Jucker, D. Landert, A. Seiler, & N. Studer-Joho (Eds.). *Meaning in the History of English: Words and Texts in Context*, pp.157-183. Amsterdam: John Benjamins.
- Clemons, P. (1959). The Chronology of Ælfric's Works. In P. Clemons (Ed.). *The Anglo-Saxons: Studies in Some Aspects of their History and Culture Presented to Bruce Dickins*, pp.212-247. London: Bowes & Bowes.
- Cook, A. S. (1898) [rpt. 1971]. *Biblical Quotations in Old English Prose Writers*, Macmillan, London, United Kingdom. (rpt.: Folcroft Library Editions).
- Curme, G. O. (1931). *Syntax*, D.C. Heath & Company, Boston, USA.
- Ellegård, A. (1953). *The Auxiliary Do: the Establishment and Regulation of its Use in English*, Almqvist & Wiksell, Stockholm, Sweden.
- Fortson, B. W. (2010). *Indo-European Language and Culture: an Introduction*. 2nd ed., Wiley-Blackwell, Chichester, United Kingdom.
- Huddleston, R. & G. K. Pullum. (2005). *A Student's Introduction to English Grammar*, Cambridge University Press, Cambridge, United Kingdom.
- Ikegami, Y. (1981). On the Development of Causative Use of the Verbs *Do* and *Make* in English. In H. Fujiwara, K. Hasegawa, Y. Ikegami, T. Kubouchi, S. Ono, K. Oshitari, H. Shimoda, & Y. Terasawa (Eds.). *Eigo no Rekishi to Kouzou: Festschrift for Prof. Kikuo Miyabe*, pp.85-99. Tokyo: Kenkyusha.
- Kaita, K. (2015). *Modal Auxiliaries from Late Old to Early Middle English – with Special Reference to *Āgan*, *Sculan*, and *Mōtan**, München, Germany, Herbert Utz.
- Ker, N. R. (1957) [rpt. 1990]. *Catalogue of Manuscripts Containing Anglo-Saxon*, Clarendon Press, Oxford, United Kingdom.
- Krug, M. (2009). Modality and the History of English Adhortatives. In R. Salkie, P. Busuttil, & J. v. d. Auwera (Eds.). *Modality in English: Theory and Description*, pp.315-347. Berlin: Mouton de Gruyter.
- Lowrey, B. (2013). The Old English Causative Verb *Hatan* and its Demise. *Token: a Journal of English Linguistics*, Vol. 2, pp.23-43. Institute of Foreign Languages UJK, Poland.
- Magennis, H. (1986). Contrasting Features in the Non-Ælfrician Lives in the Old English *Lives of Saints*. *Anglia*, Vol.104: pp.316-348. De Gruyter, Germany.
- Millward, C. M. (1971). *Imperative Constructions in Old English*, Mouton, The Hague, Netherlands.
- Mustanoja, T. F. (1960). *A Middle English Syntax*, Société Néophilologique, Helsinki, Finland.
- Nagucka, R. (1979). The Grammar of OE *Hatan*. *Studia Anglica Posnaniensia*, Vol. 11, pp.27-39. De Gruyter, Germany.
- Nykiel, J. (2010). *Expressing Obligation in Old English*, Wydawnictwo Uniwersytetu Śląskiego, Katowice, Poland.
- Ogawa, H. (2000). Initial Verb-Subject Inversion in Some Late Old English Homilies. In H. Ogawa (Ed.). *Studies in the History of Old English Prose*, pp.235-262. Tokyo, Japan: Nan'un-do.
- Ogura, M. (2000). "*Gewat* + Infinitive" and "*Uton* + Infinitive". *Neuphilologische Mitteilungen*, Vol. 101, pp.69-78. Modern Language Society, Finland.
- 2002. *Verbs of Motion in Medieval English*, D.S. Brewer, Cambridge, United Kingdom.

- Önnerfors, O. (1997). Verb-First-Deklarativsätze. Grammatik und Pragmatik, Almqvist & Wiksell, Stockholm, Sweden.
- Palmer, F. R. (2003). Modality in English: Theoretical, Descriptive and Typological Issues. In R. Facchinetti, M. Krug, & F. Palmer (Eds.). Modality in Contemporary English, pp.1-17. Berlin: Mouton de Gruyter.
- Quirk, R., S. Greenbaum, G. Leech, & J. Svartvik. (1985). A Comprehensive Grammar of the English Language, Longman, London, United Kingdom.
- Ringe, D. & A. Taylor. (2014). The Development of Old English. Oxford University Press, Oxford, United Kingdom.
- Royster, J. F. (1922). Old English Causative Verbs. Studies in Philology, Vol. 19, No. 3, pp.328-356. University of North Carolina Press, USA.
- Standop, E. (1957). Syntax und Semantik der Modalen Hilfsverben im Altenglischen *Magan, Motan, Sculan, Willan*, Heinrich Pöppinghaus, Bochum-Langendreer, Germany.
- Terasawa, J. (1985). The Historical Development of the Causative Use of the Verb *Make* with an Infinitive. Studia Neophilologica, Vol. 57, No. 2, pp.133-143. Almqvist & Wiksell, Sweden.
- Traugott, E. C. (1995). Subjectification in Grammaticalisation. In D. Stein & S. Wright (Eds.). Subjectivity and Subjectivisation, pp.31-54. Cambridge: Cambridge University Press.
- Warner, A. R. (1993). English Auxiliaries: Structure and History, Cambridge University Press, Cambridge, United Kingdom.

## **An Experimental Study of Academic English Vocabulary**

YANING XIANG\*

*1-33, Yayoicho, Inage Ward, Chiba-shi, Chiba, 263-8522 Japan*

---

### **Abstract**

For English learners, it is necessary to learn basic vocabulary at first in order to lay a foundation for more advanced study. For college students, who already have a grasp on basic vocabulary, it is important to learn academic vocabulary in order to read academic essays in English, publish on international magazines, and do presentations at international conferences. There are a lot of vocabulary lists, but few are specialized for university students. This study aims to create academic English vocabulary lists for Japanese university students, helping them strengthen their language capabilities. The created academic vocabulary lists consist of words in 5 fields: Biology, Chemistry, Earth Science, Math and Physics. All the English vocabulary data come from online academic essays. First, the raw vocabulary data are narrowed down by removing function words (*of, the, etc.*) and basic words (*student, many, etc.*). Then, the frequent words from the narrowed down lists are put into 5 questionnaires. Students in the corresponding fields are asked to assess the narrowed down vocabulary lists, answering questions such as “do you know this English word” and “the importance of the word”. Japanese translations are given next to the English words, considering that not all of the students have known all of the presented academic English vocabulary. At last, all the questionnaires are carefully analysed. The final academic vocabulary lists are made based on the questionnaires’ results.

### **Keywords**

academic vocabulary, university students, capabilities, online, questionnaire

---

### **1. Introduction**

There are lots of research concerning the average sizes of English vocabulary for both native speakers and non-native speakers. Goulden et al (1990:356) pointed out that “the average educated native speaker has a vocabulary of around 17,000 base words and has acquired them at the average rate of about two to three words per day”.

As for Japanese high-school students’ English vocabulary, according to the results of vocabulary level tests and reading tests for 260 third year high-school students,

---

\* E-mail address: kouanei@chiba-u.jp

Yamauchi (1996:6) reported that by about 60% of all the third year high-school participants showed English vocabulary sizes as 2000 words or less.

By comparing the vocabulary sizes between native speakers and non-native speakers in Japan, we can clearly recognize the gap. Nowadays, international communication, such as academic presentation, is becoming increasingly common. English capability is welcomed in every field. Under such circumstances, how to reduce the gap between English vocabulary size of Japanese learners and that of native speakers is a significant issue. For university students, who have already learnt daily communication English words in high schools, they need to expand vocabulary to academic words which are useful in specialized studies.

This study, considering the current vocabulary sizes of third year high-school students or first year university students, aims to make 5 academic vocabulary lists in 5 fields of Biology, Chemistry, Earth Science, Math and Physics.

## **2. Prior research**

### *2.1 About data collection*

Different corpora include different data that came from different sources.

BCCWJ (Balanced Corpus of Contemporary Written Japanese), a representative of contemporary Japanese written language, was made up by collecting data from books, magazines, newspapers, Internet and so on. ("Introduction to BCCWJ")

BNC (British National Corpus), a representative of "a wide cross-section of British English, both spoken and written" ("About the BNC"), was made up by collecting data from written texts and speeches.

We can recognize that written texts and the Internet are two main methods adopted to collect data. Due to the time consumption to transfer words from books to digital files, Internet is the main source to collect academic papers in this study. Further, this study chooses both ScienceDirect and Google Scholar as the source of data collection.

ScienceDirect, which "delivers over 14 million publications from over 3,800 journals and more than 35,000 books" ("Content"), was also introduced as a website offering the most digital journals in different fields in the world (Joetsu University of Education Library, 2014). Because of its variety of academic papers, this study downloads most of the data from ScienceDirect. Besides ScienceDirect, this study also uses Google Scholar as a supplement to collect academic papers. Google Scholar is regarded as a website where users can easily find lots of academic data ("About Google Scholar").

Since this study aims to create academic vocabulary lists in different fields, it was better to collect all the papers by fields, not randomly.

### *2.2 Tools used to analyze data*

Software tools are indispensable while dealing with a corpus. This study uses two software: AntConc and GoTagger.

AntConc is “a freeware corpus analysis toolkit for concordancing and text analysis” (“AntConc”). It was used by many researchers to analyze a corpus, such as Ishikawa (2012). AntConc embraces many functions like Concordance, File View, and Collocates. This study mainly focuses on two functions: Word List and Keyword List. Below is the official description about Word List from Dr. Laurence Anthony, developer of AntConc.

This tool counts all the words in the corpus and presents them in an ordered list. This allows you to quickly find which words are the most frequent in a corpus. (“AntConc Help”)

In other word, Word List presents all the words of a corpus in a list by frequency. The official description about Keyword List is as below.

This tool shows the which words are unusually frequent (or infrequent) in the corpus in comparison with the words in a reference corpus. This allows you to identify characteristic words in the corpus, for example, as part of a genre or ESP study. (“AntConc Help”)

Keyword List presents words, which are unusually frequent in one corpus but not in another, in a list by their unusual frequency. Keyword List can help to find the words that represent the characteristics of one corpus.

As for GoTagger, it is a program designed to tag words of English texts (“GoTagger”). This study uses GoTagger to tag all the English words and divides them into function words and content words based on the tags.

### 2.3. Vocabulary sizes of first year university students

Yamauchi (1996:6) reported that according to do English vocabulary and reading tests, 60 percent of Tokyo third year high-school students showed vocabulary sizes of 2000 words or less. Besides, Chino and Ominato (2007:1) also pointed out that the average vocabulary sizes of first year students in Nagaoka College in Japan were about 2370.

In this study, a word list that can represent the words that university students should have learnt in high school is necessary. *Word System 5000* (Takefuta, 1976) listed 5000 words especially for high-school students in Japan. According to “introduction”(2-8) in *Word System 5000*, we could recognize that the author selected the most frequently used words in a corpus of 9 million words which were collected from magazines, essays, academic books, conversations and so on. Then, after careful evaluation, the most possibly useful 5000 words for high-school students were picked out and formed the final word list. There is another word list called *JACET8000* (The Japan Association of College English Teachers, 2016) that lists words which university students should learn in heart. Considering the reality of current high school students' vocabulary sizes, this study uses *Word System 5000* as the representative of a standard word list that university students should have learnt in high schools.

### 3. Purpose

This study aims to make 5 academic vocabulary lists in Biology, Chemistry, Earth Science, Math and Physics to help university students to strengthen vocabulary capabilities. Besides, through learning from this pilot study, academic vocabulary lists in other fields can also be created.

### 4. Methodology

#### 4.1 Creating a corpus

As mentioned in prior research, this study collects data from ScienceDirect and Google Scholar. In order to reflect the latest trend of words usage in academic development, this study only collects papers that were published after the year of 2000.

This study collects academic papers in 28 fields and all of them form a corpus which consists of 1,218,267 words. The details are in Table 1. All the fields' names are under reference to the courses division in edX and academic fields division in JSPS (Japan Society for the Promotion of Science). JSPS, which was established with an imperial endowment in 1932, "has initiated and carried out a vast array of programs that are essential to promoting scientific research" ("About Us"). JSPS divides Science into detailed fields. For example, in Humanities, there are Philosophy, Arts, Literature and so on. edX, "an online learning destination" ("Our Story"), provides numerous online courses which are grouped by different subjects like Architecture, Chemistry and so on. Based on above information, this study collects data by the following 28 fields as Table 1 shows.

Table 1. Corpus details in fields, types and tokens

fields	types	tokens	fields	types	tokens
Art and Culture	8,412	33,760	Architecture	9,481	50,835
Business and Management	8,487	36,942	Biology	9,867	42,423
Communication	10,230	48,446	Chemistry	9,409	41,184
Economics and Finance	8,831	40,331	Computer Science	8,086	35,558
Education	8,068	38,981	Industrial Design	8,546	35,169
Ethics	9,199	40,336	Electronics	9,111	40,304
History	11,522	49,630	Earth Science	10,487	49,697
Humanities	8,686	38,383	Engineering	7,064	30,211
Language	8,624	39,268	Environmental Studies	11,868	59,543
Law	10,998	53,255	Food and Nutrition	11,305	62,196
Literature	9,455	36,114	Health Safety	12,070	68,719
Music	6,854	27,905	Math	8,320	37,784
Philosophy	9,258	42,026	Medicine	10,474	60,078
Social Sciences	8,076	33,918	Physics	8,850	45,271

As a pilot study, this study creates 5 academic vocabulary lists in the fields of Biology, Chemistry, Earth Science, Math and Physics.

#### 4.2 Definition of Academic Words

Since this study aims to make academic vocabulary lists for university students, it is necessary to remove all the words that university students should have learnt in high schools. As mentioned in 2.3, *Word System 5000* (Takefuta, 1976) is the representative of what university students should have learnt in high schools. Therefore, all the words in *Word System 5000* are removed. Besides *Word System 5000*, one more kind of words are not the wanted academic words either: function words.

There are two groups of words in English: function words and content words. Function word is “a word that does not mean anything on its own, but shows the relationship between other words in a sentence, for example words such as *but* or *if*” (LDOCE S.V. Function Word). Content word is “a word to which an independent meaning can be given by reference to a world outside any sentence in which the word may occur” (Collings English Dictionary S.V. Content Word). According to the definition and purpose of this study, function words are not counted as wanted academic words in this study.

Therefore, in this study, the wanted academic words are selected from the word lists that are removed all the function words and words in *Word System 5000* (Takefuta, 1976).

#### 4.3 Content and function words' division

Based on the definitions in dictionaries mentioned in 4.2, this study divides all the words into function and content ones as Table 2 shows.

Table 2. Function and content words division

CONTENT WORD		FUNCTION WORD	
Tags	tags' meaning	tags	tags' meaning
CD	Cardinal number	CC	Coordinating conjunction
FW	Foreign word	DT	Determiner
JJ	Adjective	EX	Existential there
JJR	Adjective, comparative	IN	Preposition/subord conjunction
JJS	Adjective, superlative	LS	List item marker
NN	Noun, singular or mass	MD	Modal
NNS	Noun, plural	PDT	Predeterminer
NNP	Proper noun, singular	POS	Possessive ending
NNPS	Proper noun, plural	PRP	Personal pronoun
RB	Adverb	PRP\$	Possessive pronoun
RBR	Adverb, comparative	RP	Particle
RBS	Adverb, superlative	SYM	Symbol
VB	Verb, base form	TO	to
VBD	Verb, past tense	UH	Interjection
VBG	Verb, gerund/present participle	WDT	wh-determiner
VBN	Verb, past participle	WP	wh-pronoun
VBP	Verb, non-3rd ps. sing.	WP\$	Possessive wh-pronoun
VBZ	Verb, 3rd ps. sing. Present	WRB	wh-adverb

#### 4.4 Automatic improvement of raw data



Through AntConc and GoTagger as mentioned in prior research, the raw vocabulary data in the 5 fields are narrowed down respectively by removing all the words in *Word System 5000* (Takefuta, 1976) and all the function words mentioned in 4.3. The result vocabulary lists are called “vocabulary lists 1” in this study.

As mentioned in 2.2, through Keyword List, we obtain the word lists that represent the characteristics of the corpus, which are called “vocabulary lists 2” in this study. This study obtains “vocabulary lists 2” in 5 fields by comparing “vocabulary lists 1” in 5 fields with BNC, a corpus of “a 100 million word collection of samples of written and spoken language from a wide range of sources” (“BNC”). Because BNC enjoys a large collection of data from wide range of sources, it serves as a good reference corpus since subject corpus is an academic vocabulary assembling.

#### 4.5 Author’s further improvement

Although all the lists are removed all the function words and words in *Word System 5000* (Takefuta 1976), it is necessary for author to check the results. For example, there is word *datum* in *Word System 5000* but no plural one *data*, which should be removed as the word that university students should have learnt in high schools. This study checks all the vocabulary lists to remove the similar derivative terms. But if there were changes in meaning, the derivative would be left. For example, verb *tolerate* means “to be able to accept something unpleasant or difficult, even though you do not like it” (LDOCE S.V. Tolerate). But *tolerance* is not just the acceptance of something you might not agree, but also can be used in mathematics or engineering meaning “the permitted variation in some measurement or other characteristic of an object or workpiece” (Collings English Dictionary S.V. Tolerance). Under such circumstances, *tolerance* will be left.

Through author’s check, this study attains the improved “vocabulary lists 1” and “vocabulary lists 2 ” in 5 fields.

#### 4.6 Questionnaires

The frequently used words in improved “vocabulary lists 1” and “vocabulary lists 2” are put together in questionnaires by fields. Students in the corresponding fields are required to assess all the words. Because not all the studetns have already known all the English vocabulary, Japanese translations given next to the English words can give reference. For example, part of the questionnair in Math is like figure 1.

The results are evaluated based on the percentage of “do you know the English word”, “do you know the Japanese translation” and “the importance of the word” (5 being the most). In this study, words that are classified as the wanted academic words must satisfy:

- 1, the percentage of “I know the English word” ≠ 100%;
- 2, the percentage of “I know the Japanese translation” > 50%;
- 3, the average importance > 2.5.

English	Japanese								
( ) constraint	( ) 強制, 束縛, 拘束, 圧迫; 制約	Not Important							Important
( ) hypothesis	( ) 假説, 假定, 前提	Not Important							Important
( ) pre-test	( ) 予備テスト	Not Important							Important
( ) interactive	( ) 相互に作用する, 相互作用の	Not Important							Important
( ) post-test	( ) [教育] 効果測定試験, 事後テスト	Not Important							Important
( ) disposition	( ) (1)配置(2)【法律】譲渡; 処分 (3) 傾向 (4)傾向	Not Important							Important
( ) stereotype	( ) 定型; (社会) 固定観念	Not Important							Important
( ) deviation	( ) (方針・道徳・標準・規範などから) それること, 逸脱	Not Important							Important
( ) elementary	( ) 初歩の, 初等の, 入門の; 基本の, 基本的原理の	Not Important							Important
( ) excerpt	( ) 抄録, 抜粋, 引用句, 抜粋曲	Not Important							Important
( ) induction	( ) 誘発, 誘導, 導入, 帰納法	Not Important							Important
( ) derivative	( ) 引出されたもの, 派生物, 導関数, 微分係数	Not Important							Important

Figure 1. Questionnaire in Math

For example, *hypothesis*, *elementary* are two words that 100% students know the English words and Japanese translation. Although their average importance is graded above 4, these words are not considered as the wanted academic words in this study. *Constraint* is a word that only 20% know the English word, but 80% know its Japanese translation and its importance is graded as 3.8. *Constraint* is the word that this study wants. *In-service* is a word that 0% know the English word and 60% know its Japanese translation. But considering its importance is graded under the average importance 2.5, this study does not involve this word as the wanted academic words.

## 5 Results

According to the evaluation standard as mentioned above, this study obtains academic vocabulary lists in Biology, Chemistry, Earth Science, Math and Physics.

Table 3. Academic vocabulary list in Biology

antireductionism	fungus	pathogen	algorithm	asynchronous
hyphae	computational	sub-stomatal	necrotrophic	methodological
fractal	endosome	monism	dispensable	simulation
qb (quantum biology)	classical	interaction	execution	episode

Table 4. Academic vocabulary list in Chemistry

synthesis	uranyl	aqueous	conjugated	optimal
derivative	solvent-free	condensation	electron	heterocyclic
medicinal	thermodynamic	fuse	pharmaceutical	catalyst
reflux	aromatic	tetrahedron	ligands	subsequent
IC (Isotope Chemistry)	nitrogen			

Table 5. Academic vocabulary list in Earth Science

asteroid	grid	thermodynamic	computation	empirical
velocity	interface	emission	causality	combustible
hydroelectric	vector	GDP(Gross Domestic product)	stand-off	aggregate
diameter	consistent	hydropower	simulation	eustatic
classification	respectively	deflection	decomposition	mitigation
array	entity	algorithm	tectonic	nexus
basin	paleocene	parameter	stand-on	oxide
chromium	coating	passive		

Table 6. Academic vocabulary list in Math

constraint deviation	pre-test excerpt	post-test induction	interactive covariance	disposition affirmation
algorithmic				

Table 7. Academic vocabulary list in Physics

simulation	temporal	decay	threshold	parameter	disposition
electroweak	plasma	dislocation	orthogonal	execute	nonlinear
residual	tolerance	copper	transient	isotope	convergence
algorithm	refinement	coefficient	derivative	cosmology	hydraulic
retrieve	interface	interaction	equilibrium	inquisitiveness	truncation
iteration	grid	preconditioning	infrared	computational	mechatronics
vector	matrix	respectively	prototype		

Under evaluation standard(1, the percentage of “I know the English word” ≠ 100%; 2, the percentage of “I know the Japanese translation” > 50%; 3, the average importance > 2.5), the percentages of the number of the wanted academic words in the number of words in questionnaires are: Biology, 32%; Chemistry, 35%; Earth Science, 54%; Math, 58%; physics, 67%.

There are probably 2 reasons accounting for the fact that Math has the least academic words among 5 fields. The first is because of the least data collection in Math compared with other fields; the second is because in academic papers in Math, the fact that lots of calculation process or results taking a large coverage of the texts cannot be neglected.

Earth Science and Physics enjoy high percentage of wanted academic words in questionnaires. It is not just because of their large collection of data compared with others, but also because of the fact that there is 0 word whose percentage of “I know the English word” is 100% and “I know the Japanese translation” also 100% in the questionnaires. It means that no words are considered as not wanted academic vocabulary because 100% participants know their English spellings and Japanese translations. With Biology 32%, Chemistry 17%, Math 26%, we can recognize that words in Earth Science and Physics are relatively difficult compared with words in other fields.

## 6 Summary and Discussion

This study created a corpus consisting more than 1 million words data in 28 fields and made academic vocabulary lists of 5 fields in Biology, Chemistry, Earth Science, Math and Physics. After automatic effort by software, author further improved the results manually. The final academic vocabulary lists were results that were selected by university students in the corresponding fields.

Rethinking about the results of this study, author recognized that they were closely related to the corpus size and evaluation standard. To raise accuracy, bigger corpus will be created in the next study. Evaluation standard can be adjusted according to the target of study. For example, all the derivative terms of words in *Word System 5000* were removed in this study, but word like *qualitative*, which is the adjective of *quality*, actually was not known by many students. Therefore, it is important to rethink which kind of words should be removed or left. Besides, the evaluation standard to select the academic words also can be re-considered. For students that do not have a large size of English vocabulary, more words should be included. Thus, relaxing the current criteria is significant.

## References

- "About Us". JSPS. (2015). <https://www.jsps.go.jp/english/aboutus/index.html>. Last accessed 13 Oct. 2016.
- "About Google Scholar". URL: <https://scholar.google.co.jp/intl/ja/scholar/about.html>. Last accessed 13 Oct. 2016.
- "About the BNC". (2015). British National Corpus. [Oxford Text Archive, IT Services, University of Oxford. http://www.natcorp.ox.ac.uk/](http://www.natcorp.ox.ac.uk/). Last Accessed 12 Oct. 2016.
- "AntConc". (2016). Laurence Anthony's Website. <http://www.laurenceanthony.net/software.html>. Last Accessed 13 Oct. 2016.
- "AntConc Help". (2016). Laurence Anthony's Website. <http://www.laurenceanthony.net/software/antconc/releases/AntConc344/help.pdf>. Last Accessed 13 Oct. 2016.
- Collings English Dictionary. Available Online: <http://www.collinsdictionary.com/>.
- Chino, Junichiro. Ominato, Yoshihiro. (2007). The Development of the Vocabulary Size of Japanese EFL Learners. Nagaoka National College of Technology, V. 43, No. 1, pp.1-10. NII-Electronic Library Service, Japan.
- "Content". (2016). ELSEVIER. <https://www.elsevier.com/solutions/sciencedirect/content>. Last Accessed 13 Oct. 2016.
- "GoTagger". (2010). GOTO Kazuaki Website. <http://web4u.setsunan.ac.jp/Website/GoTagger.htm>. Last Accessed 14 Oct. 2016.
- Goulden, R. Nation, Paul. Read, John. (1990). How Large Can a Receptive Vocabulary Be? Applied Linguistics, Vol. 11, No. 4, pp. 341-363. Oxford University Press.
- "Introduction to BCCWJ". (2009). Center for Corpus Development NINJAL. [http://pi.ninjal.ac.jp/corpus\\_center/bccwj/](http://pi.ninjal.ac.jp/corpus_center/bccwj/). Tachikawa, Tokyo. Last Accessed 12 Oct. 2016.
- Ishikawa, Shin-ichiro. (2012). A Basic Guide to Corpus Linguistics, Hituzi Shoten, Tokyo, Japan.
- Joestu University of Education Library. (2014). 30 pun de wakaruru ScienceDirect ('ScienceDirect made comprehensible in 30 minutes'). Joestu University of Education. <http://www.lib.juen.ac.jp/research/pathfinder/30min-ScienceDirect.pdf>. Last Accessed 13 Oct. 2016.
- JSPS. (2010). Japan Society for the Promotion of Science. <https://www.jsps.go.jp/j-jisedai/data/05bunyahyo.pdf>. Last Accessed 17 Oct. 2016.
- LDOCE. Longman Dictionary of Contemporary English. Available Online: <http://www.ldoceonline.com/>.
- "Our Story". (2016). edX. <https://www.edx.org/about-us>. Last Accessed 17 Oct. 2016.
- Takefuta, Yukio. (1976). Word System 5000. Jukenkouza encourage English (English Exam Course). Special Issues (Feb 1<sup>st</sup>, 1991), Fukutake Shoten.
- The Japan Association of College English Teachers. (2016). The New JACET List of 8000 Basic Words (New JACET8000). Kirihara Shoten.
- Yamauchi, Yutaka. (1996). Development of a Vocabulary Level Test for EFL Learners: The Relationship between learners' Vocabulary Size and Reading Comprehension Skills. KATE Journal (10), 1996-03-01. pp. 1-13. KATE.

**Topic :** Social Sciences and Sustainabilities

## **Promoting Cities through Shopping Street Unions in Japan**

**Masakazu Ito\***

*Chiba University, Graduate School of Social Sciences and Humanities, 1-33 Yayoi-cho  
Inage-ku Chiba-shi 263-8522, Japan*

---

### **Abstract**

Some sociologists and commercial scientists have claimed that shopping streets serve various functions in the local ecosystem and culture. In particular, urban sociologists have claimed that streets are contexts of globalization (immigration) and gentrification (urban development). In Japan's case, however, there is limited influence of immigration on shopping streets. Moreover, Japanese shopping streets are not the main target of urban development; therefore, it is necessary for studies on Japanese shopping streets to analyze what affects of globalization and gentrification. This paper argues that promoting cities can play a significant role for them.

To achieve this purpose, I conducted a case study of activities in a Japanese shopping street union: fieldwork and interview at Sengen shopping street in Chiba City. Japanese shopping street unions have a history of accepting social policy for shopkeepers. However, against this history, some argue whether shopping street unions are conservative groups or not.

On the other hand, changes in social policy have emphasized city promoting. This trend influences shopping streets; some shopping street unions function as protectors of local ecosystem and culture. When shopping street union's activities expand local culture and promote the city, the local community can undergo globalization and gentrification. Some Japanese shopping streets are tourist attractions. In Japan, promoting cities via shopping street unions is a key to the future development of shopping streets. In particular, tourism strategy facilitates their globalization and gentrification.

### **Keywords**

shopping street, globalization, gentrification, local community

---

## **1. Study on shopping streets**

### *1.1. Studies by sociologists and commercial scientists*

Some sociologists and commercial scientists have claimed that shopping streets perform various functions in the local ecosystem and its culture. Moreover, sociologists

---

\* Corresponding author. Tel.: +81-090-1807-6919.  
E-mail address: adua2932@chiba-u.jp

have observed that shopkeepers have cooperated with local residents to manage local festivals and have participated in the efforts of residents to solve tasks associated with local governance such as ascertaining political opinions (Tamano 2005). Shopkeepers in shopping street unions have become part of a maintenance function for local culture and, through the pressure they exert, have political significance.

Commercial scientists have considered shopping streets as important for central city revitalization. They have claimed that shopping areas have created “prosperity” (called *nigiwai*) and have formed a local economy inspired by consumers’ shopping (Ishihara and Nishimura 2010). Shopping streets, therefore, have an important economic function in local communities.

Studies on shopping streets have claimed that there are social functions that are managed by shopping streets (Ito 2016).

### 1.2. *Studies by urban sociologists*

In particular, urban sociologists have claimed that streets are contexts for globalization (immigration) and gentrification (urban development). Shopping streets associated with the context of globalization accept immigrants for employment, which is often their first work experience. Shopping streets in context of gentrification are involved in urban development, which, paradoxically, often cannot accept people who are immigrants or those with a low-income (Zukin, Kasinitz & Chen 2016).

There are some steps that take place in order for gentrification to be reached. In the first instance, a street with low rent attracts immigrants and people with a low-income (for example, students and fledgling artists). They gradually form a unique culture with the opening of various shops and art galleries (Sasajima 2016). Second, this unique culture attracts interest to the street. It also brings in tourists and those interested in art. The third step is the influx of big capital (a large corporation or an urban policy) that has a rapid impact on the street. This leads to soaring property values and a “scrap and build” form of exclusion to immigrants and low-income residents.

### 1.3. *Shopping streets in Japan*

In Japan's case, however, there is limited influence of immigration on shopping streets. Moreover, Japanese shopping streets are not the main targets for urban development. In fact, during the last 30 years, shopping streets have been in decline and are labeled “shutter streets” as shopkeepers cannot keep their businesses afloat and building owners cannot find tenants. According to the Shopping Streets Actual Condition Survey (Small and Medium Enterprise Agency 2016), the rate of “Prospering” and of those with an “Indication of prospering” stands at a mere 5.3%. Meanwhile, the rate of “Declining” businesses and of those “Afraid of declining” is as high as 66.9% (Table 1). Majority of Japanese shopping streets do not make money for the business owners who would benefit from urban development.

Table 1. Business conditions of shopping streets in 2015

Business conditions	Rate
Prospering	2.2%
Indication of prospering	3.1%
Flat	24.7%
Afraid of declining	31.6%
Declining	35.3%
No answer	3.1%

Source: Shopping Streets Actual Condition Survey  
(Small and Medium Enterprise Agency 2016: 34)

Meanwhile, globalization gradually influences shopping streets from attracting tourists. There are some Japanese shopping streets that are tourist attractions, such as

Asakusa and Yanaka. Asakusa has a historic temple city that continues to prosper. The shopping streets in Asakusa naturally flourish because of their location near to such historic landmark. In Yanaka, there are guest houses and youth hostels supporting foreign travelers. In addition, townscape which is called *shitamachi* and means the expression of Japanese nostalgia (about 1950s-1970s) is maintained by the shopping street union.

Globalization from tourism may offer a guide to indicate gentrification. Therefore, it is necessary for studies on Japanese shopping streets to analyze the effects of globalization and gentrification on such streets. This paper argues that promoting cities can play a significant role. In order to achieve this, I conducted a case study of the activities of a Japanese shopping street union.

## **2. Japanese shopping street unions**

### *2.1. History of Japanese shopping street unions*

Japanese shopping street unions have a history of accepting social policy for shopkeepers. Between World War I and World War II, there was an inflow of people from the rural countryside into urban areas who soon constituted a new low-income class. They made a living from trade learned through trial and error. In order to get relief from pressures associated with urbanization, they established shopping street unions. This phenomenon of urbanization is not unique to Japan and can also be observed in other parts of the world (Arata 2011).

During the high economic growth period (1954-1973), there was the emergence of a white-collar class, also termed a new middle class. At the same time, an urban self-employment class (shopkeepers) was established by national social policy that regulated to build big stores. The development of these two classes became known as the “stability of both wings” (Arata 2012).

### *2.2. Recent trends of Japanese shopping street unions*

Bearing this history in mind, some argue whether shopping street unions are conservative groups or not. In actuality, after the high economic growth period, shopping street unions claimed that they were opposed to the building of big stores near their streets and they wanted a social policy to be in place that would allow them to receive financial assistance. Such attempts have led to the formation of the impression that the shopping street unions have a conservative agenda.

Conversely, in around the year 2000 the “sharing equally” social policy changed into the policy of “supporting for working hard” social policy (Nakazawa 2001). This policy’s development led to a reconsideration of whether shopping street unions are truly conservators, since this policy shift acted towards the promotion of cities.

The broader Japanese social circumstances, which include challenges such as declining birthrate, the growing number of elderly people and the experience of natural disasters (for example, the Kobe earthquake and the Tohoku earthquake) demonstrated the necessity of having a vibrant local community. Such trends influenced shopping areas with some shopping street unions functioning as the protectors of the local ecosystem and culture.

## **3. Case study of the Sengen shopping street in Chiba City**

### *3.1. Shopping street unions in Chiba City*

Chiba City is the capital of the Chiba Prefecture that is contiguous with the Tokyo Metropolitan area. In 2016, 49 unions belonged to the Chiba City shopping street union. The average number of shops in these unions stands at 44.92 shops. However, there was only information about 26 of the unions on the Chiba City shopping street union's website. Of these 26 unions, 22 managed original events, and only seven unions have original websites (Chiba City Shopping Street Union 2016). Therefore, we cannot conclude that shopping street unions in Chiba City necessarily prosper.

### 3.2. Sengen shopping street in Inage area

Inage area belongs to Inage Ward in Chiba City. The Inage area is a suburb that has access to Tokyo station, which is about 35 minutes away from the area by the rapid train operated by Japan Railways (JR). The size of the Inage area is roughly equal to that of a junior high school district.

Table 2. Population of Chiba City, Inage Ward and Inage area (2010)

		Chiba City	Inage Ward	Inage area
Population	Total	961,749	157,768	20,264
	Male	480,194	78,835	10,129
	Female	481,555	78,933	10,135

Source

:National

Population Census 2010

In the past, the Inage area had a view of the ocean and was a farming and fishing village. In 1921, Keisei Railway opened traffic between Oshiage station in Tokyo and the Keisei Inage station. The Inage area was prospered as a health resort for cultural people, while the masses flocked to its beaches. During this time, the Sengen shopping street began to prosper.

However, in 1961, the area, especially the beach, became subject to urban development and was soon transformed into a dormitory suburb of Tokyo for white collars workers. The central part of the Inage area saw the moving of the Keisei Inage station to the JR Inage station. Finally, in 1981, the JR Inage station could accept rapid trains, which added to the image of the Inage area have been thought as a dormitory suburb. The construction of projects such as "Proud Tower Inage" (37 floors, 354 rooms, built in September 2009) and "Willis Inage" (14 floors, 929 rooms, built in February 2015) became symbolic condominiums of a dormitory suburb.

The Sengen shopping street, with a total length of about 600 meters, has been managed by the Inage shopping street promoting union that was established in 1963. By 2016, there were 37 shops that were members of this union (the number of shops not in the union stands at 28). The shoppers are predominantly senior residents who have access to the Sengen shopping street and go there on foot. This shopping area was an example of a typically declining Japanese shopping street in Japan until around 2004 when the union started two main activities in the Inage area.

### 3.3. Activities in Sengen shopping street

*"One Shop, Great Products Movement" (called "Itten Ippin Undo" started in 1993)*

The above movement inspired shops to consider product development. In this initiative, each shop was to create "great" products and sell them. Recently, an incorporated non-profit organization (NPO) called the One Shop, Great Products Movement Association, established in 2007, chose to support shopping street unions. The association opened lectures for product development, supported the teaching and learning of product design, and promoted a "great" products fair in the shopping streets. Furthermore, it created networking opportunities for each shopping street unions. The primary characteristic of the movement is routine participation in product learning and for the exchange of views and opinions about each product. However, because these



programs gathered shopkeepers together, many shopping street unions limited their participation in the movement.

In the case of the Inage shopping street, union participation in the movement of 2004, stood at around one-third of union members.

Table 3. Participants of the One Shop, Great Products Movement in the Inage Shopping Street Promoting Union

year	2006	2007	2008	2009	2010	2011	2012	2013	2014
shops	9	10	11	13	12	10	11	12	11

Source: Leaflets of the Great Products Fair Made by the Inage Shopping Street Promoting Union

One-third of the members attended a “great” products fair, which presented the “great” products of each shopkeepers. In addition, one-third of the members managed walking tours of the Inage area. They introduced not only their products but also historical places of significance during the tours. This constituted function of promoting the city as well as their activities.

#### “Yotoboshi”

The formal name of Yotoboshi is the “Inage Akari Festival Yotoboshi” and it was established in 2006. The origin of the festival is *Yotoboshi-ryo* which consists of fishing at night while playing with a carbide lamp (an old model lantern called *kantera*) in a shallow beach. This ocean view is reproduced with handmade candle lanterns (called *touru*). The body of the lantern is made form laminated Japanese paper (called *washi*) and primary school children draw pictures on it.

*Yotoboshi-ryo* is the symbol for the memory of the Inage area where old residents once had an ocean view. In 1961, as a result of the business of reclamation, the memory from the Inage beach was buried. Yotoboshi is the place where older residents reminisce and make new memories for younger residents who have no recollection of the Inage beach.

Yotoboshi does not originate from religion or a belief in God. It is managed by the Yotoboshi executive committee and organized by its main members in the Inage shopping street promoting union. They succeeded to make a symbol of the Inage area. There were about 1,000 candle lanterns in the first Yotoboshi; however, during the 10th Yotoboshi in 2015, there were as many as 8,000 candle lanterns. The event became so significant that the name of Yotoboshi got featured in guide book published by the Chiba City Tourism Association.

### 3.4. Tourism Strategy in Shopping Streets

Shopping street unions are organized for shopkeepers so that they may profit. In particular, the “One Shop, Great Products Movement” seeks to improve the functioning of the local economy. In the case of the Inage shopping street promoting union, their movement has the function of promoting the city. They hope to offer prosperity not only to the shops in Sengen shopping street but also to the Inage area at large.

Moreover, the Inage shopping street promoting union has the function of creating a local culture and the maintenance of this culture through the Yotoboshi. A Japanese tea shopkeeper who is a member of the union emphasized that helps the “pride of the community,” offers a “festival for children,” and contributes to the “management of neutral position in the community” (interview August 29, 2012.).

These two activities in the Sengen shopping street work with members of the Inage shopping street promoting union to consider ways of promoting the Sengen shopping street and Inage area. In this case, meaning of “promote” is how they work to make shoppers’ and visitors’ look at the stores. In other words, this leads to “tourist gaze” (Urry & Larsen 2011). In addition, such activities promote the way in which cities can attract tourists.

## 4. Conclusion

### 4.1. *Indication of globalization and gentrification in Japanese shopping streets*

The activities of Japanese shopping street unions tend to promote the cities. When the shopping street union's activities expand local culture and promote the city, the local community can undergo globalization and gentrification.

Shopping street unions of not only famous streets but also non-famous streets choosing tourism strategy are gradually increasing. Generally speaking, these shopping street unions try to form things that can symbolize the city and try to maintain it. Shopping street unions working hard try to create symbols of the city such as historic landmarks, townscape expressing Japanese nostalgia, new festivals, "holy place" about cartoons or animation (background of the cartoons or animation), B class gourmet, and "Yuru-chara" (original local cartoon-character costume). Japanese people who get tired of Tokyo, Osaka and Kyoto already search and walk around the niche places. Foreigners start following this gradually. Therefore, there is an indication of globalization from tourism.

### 4.2. *Conclusion*

In Japan, promoting cities via shopping street unions is a key to the future development of shopping streets. Will declining shopping streets be included in residential areas and business districts, leading to their redevelopment, or will they be converted into ghost towns? Shopping street unions are increasingly striving toward promoting the city through methods such as social movements. In the case of tourism strategy, do hard-working shopping street unions involve or resist gentrification? The answer to this depends on the thought of promoting cities.

## References

- Arata, Masafumi. (2011). Ryo-taisen-kanki Globalization ni okeru <Syotengai> no Keisei (Forming <Shopping Street> in Globalization between World War 1 and World War 2). In Endo, Kaoru (Ed.). Globalization to Toshi-henyou (Globalization and Urban Transformation), p.251-275. Sekaishisousha, Kyoto, Japan. [in Japanese]
- Arata, Masafumi. (2012). Syotengai wa Naze Horobirunoka (Why Shopping Street Disappear?), Kobunsha, Tokyo, Japan. [in Japanese]
- Chiba City Shopping Street Union. (2016). Shopping Street Unions in Chiba City, Chiba, Japan. <http://www.chiba-shopstreet.com/member.html> Last Accessed 20 October 2016.
- Ishihara, Takemasa & Nishimura, Sachio (Eds.). (2010). Machizukuri wo Manabu (learning the Town Planning), Yuhikaku, Tokyo, Japan. [in Japanese]
- Ito, Masakazu. (2016). Machizukuri-shiko no Syotengai-ron ni taisuru Chiiki-syakaigaku-teki Approach no Houto: Syotengai no Syakai-teki-kinou ni Chakumoku shite (Way of Regional and Community Studies to Shopping Street Studies of Town Planning Intention: Focusing on Social Functions in Shopping Street). In Yonemura, Chiyo (Ed.). Social Bonding in Fluid Societies, p.51-63. RESEARCH PROJECT REPORTS, No.301. Chiba University Graduate School of Humanities and Social Sciences, Chiba, Japan. [in Japanese]
- Nakazawa, Takao. (2001). Kawaru Syotengai (Changing Shopping Streets), Iwanamisyoten, Tokyo, Japan. [in Japanese]
- Tamano, Kazushi. (2005). Tokyo no Local Community (Local Community in Tokyo), Tokyodaigakusyuppankai, Tokyo, Japan. [in Japanese]

- Sasajima, Hideaki. (2016). Artist-led Gentrification of SoHo in New York City: The Birth of the Art Gallery District from 1965 to 1971. *Japanese sociological review*, Vol.67, No.1, pp.106-121. Yuhikaku, Tokyo, Japan. [in Japanese]
- Small and Medium Enterprise Agency. (2016). Shopping Streets Actual Condition Survey, Tokyo, Japan. <http://www.chusho.meti.go.jp/shogyo/shogyo/2016/160322shoutengaiB.pdf> Last Accessed 20 October 2016.
- Urry, John & Larsen, Jonas. (2011). *THE TOURIST GAZE 3.0*, Sage Publications, London, United kingdom.
- Zukin, Sharon & Kasinitz, Philip & Chen, Xiangming. (2016). *Global Cities, Local Streets: Everyday Diversity from New York to Shanghai*, Routledge, London, United Kingdom.

---

## **The Importance of Paddy Rice Production for the Agricultural Communities in the Highland of South Sulawesi**

Muhammad Agung Ady Mangilep\*

*Chiba University, 1-33 Yayoi-cho, Chiba-shi 263-0022, Japan*

---

### **Abstract**

This article aims to reveal farmers' intention on the continuation and improvement of, and the adoption of new methods for paddy rice production in the highland of South Sulawesi. A series of interviews with farmers were conducted in the Enrekang Regency, the Toraja Regency, and the North Toraja Regency in order to obtain descriptive data on the paddy rice production, agricultural technologies, land ownerships, and farmer's income sources. Paddy rice fields in these areas are generally short of water supply and their sizes are limited by the shape of the hilly land surface. Farmers in the Enrekang Regency maintain a paddy rice production as a part of their horticulture production cycle. In that area, red onions are commercially produced twice in a year, and paddy rice is produced non-commercially once in a year between red onion productions. That cycle has effectively reduced pests on the red onions. Farmers also keep paddy rice productions for food stocks and for preserving their agricultural lands in a good condition. They use both local and government's varieties alternately to increase the paddy rice production. A turn to produce on the agricultural land is rotated among all family members. Farmers in the Toraja Regencies maintain a paddy rice production to serve symbolic dividends on a collective ownership of the big family assets. Agricultural land is an important family asset since it is a part of the Tongkonan. Their non-commercial paddy rice production preserves an agricultural environment and keeps land values. The Tongkonan has been served as the main place for a funeral ceremony of a deceased family member. That ceremony holds the most important aspect in an agricultural community life, where water buffaloes are used for a bull-fighting attraction and served as foods. Both the paddy rice production and the water buffalo breeding sustain the non-monetary economic welfare in this region, though the water buffaloes are also sold in the market for their income. Income of farmers comes mostly from a water buffalo breeding and plantations of commercial agricultural products such as a coffee and a clove.

### **Keywords**

Paddy rice production; farmer behavior

### **1. Introduction**

This research is aimed to find out farmer perspectives on the continuation and improvement of, and adoption of new methods for paddy rice production in South Sulawesi. The descriptive data of this research were collected by field

---

\* Muhammad Agung Ady Mangilep. Tel.: +8-170-1388-9122  
*E-mail address:* agung@chiba-u.jp

studies. Field studies were conducted by me to interview South Sulawesi farmers in Enrekang Regency, North Toraja Regency, and Tana Toraja Regency. Based on my notes and records of these interviews, this research reveals that a motivation of farmers depends on agricultural production other than the paddy rice production; and the need for maintaining a close relationship among members of a big family.

The demand, the price and the production of paddy rice have been increased for years in Indonesia, but that production at upland of South Sulawesi has been stagnant and tends to decrease. Although the current prices of local rice varieties of highlands are more than and the current prices of lowland rice varieties, it is not as high as those of other competitive commercial agricultural products. For an example, red a kilogram onion price is more than twice of rice price. It can be produced 3 times a year, while paddy rice production only once a year. In 1 hectare, a red onion production can produces about 3 times more than paddy rice. So there is no incentive for farmers to continue a paddy rice production for a commercial purpose. Mostly, the purpose of paddy rice production there is a self-consumption by the family.

In Enrekang Regency, farmers had kept a paddy rice production as a part of another agricultural production which has a competitive commercial value in the market. In Toraja Regencies, the paddy production is also used to keep a relationship among members in a big family in which all members of the family have their willingness to secure their dividends on the agricultural land.

## **2. General Situation of Paddy Rice Production at Uplands of South Sulawesi**

The South Sulawesi province is one of provinces at the Celebes island in Indonesia and Celebes island is one of the main islands which is located at the center of Indonesia. The South Sulawesi province is one of the most important rice production centers in Indonesia. Kompas.com (2013) mentioned the South Sulawesi province produced rice about 540,000 ton in 2013. However most of paddy rice in the province is produced in the lowland areas. In upland areas of South Sulawesi, most of farmers have lands, which belong to their family members, and they are not available for sale or for rent. They own about 1 to 2 hectares of irregular-shape fields, but only some part of them are allocated to a paddy rice production. Farmers cultivate paddy rice on the terrace fields at hilly mountain sides, most of which are rainfed fields. Some areas are close to a river and have irrigation channels. According to Accuweather (2016), the temperature in those regencies is 15 to 25 °C. It is about 10 °C lower than that of the lowland areas. Most of the government varieties can grow in about 3 months, while most of local varieties need about 6 months. Although government subsidized paddy varieties have a higher productivity than others, only a few varieties can grow normally in such an environment. The local varieties have a lower productivity, but all of them are suitable for the upland condition, so that farmers keep producing local varieties.

Farmers who participate in the interviews mentioned production of local paddy rice varieties are done once a year in a rainy season. A transplanting of seeds starts from February. Before it, land must be prepared by plowing the soil and then flattening the land, which can be done by using a hand-tractor. A hand-tractor can be borrowed from a farmer group to which the farmer belong, or can be rent from other farmers who own one privately. After plowing the soil, farmers prepare seeds in a separated section of a field. After they germinate, which usually take a month, farmers start to transplant seedlings by hiring neighbourhood farmers. At some fields closed to a river with an irrigation channel system, farmers combine a paddy rice production with a fish pool. Chemical fertilizers are subsidized by government and they should be applied to the plants twice, first after transplanting and secondly before paddy fruits come up, but farmers producing on fertile lands leave the plants without any chemical fertilizer. For a pest control, farmers buy chemical pesticides, herbicides, and mouse poisons by themselves. Chemical pesticides can be applied for a pest control, which depend on pest types such as insects and microbes. A set of scarecrow is used to dispel sparrows. A weeds control can be done by applying herbicide, but is mostly done by farmers' own field work. When the color of plants turns yellow, usually after 6 months, paddy plants can be harvested by using "ani-ani", a specific cutter for a long paddy straw. For harvesting, farmers hire neighbors who have participated in transplanting. Harvested paddy rice is gathered on a section of field and then they are defoliated, sometimes by using a defoliation machine. Then, rice is cleared and dried under the sunlight. A dried rice will be kept in a house or a rice storage.

Farmers produce other agricultural products other than paddy rice. They produce red onion and other vegetables. A publication of Enrekang Regency's government (2016) mentioned red onion price is about Rp 20,000 to 32,000 per kilogram. They also grow plantation such as cloves and coffee. Harga.web.id (2016) mentioned cloves price was about Rp 100,000 per kilogram and Othervisions (2013) mentioned cloves plantation produces about 0.5 to 1.5 ton per hectare once a year. Tanimedia.com (2013) mentioned a coffee plantation produces about 0.5 - 1.5 tons in 1 hectare a year and Veco Indonesia (2015) mentioned coffee bean price was about Rp 100,000 per kilogram. De Jong (2013) mentioned Torajan Arabica varieties have a stable price. They also breed cattles and water buffaloes. TribunToraja.com (2016) mentioned price of a water buffalo was about tens of millions Rupiah to billions Rupiah.

### **3. Method of Field Study**

Field study is done on 3 regencies namely the Enrekang regency, the Tana Toraja regency and the North Toraja regency. Those regencies is located in the upland and they have aromatic local paddy rice varieties. Lestaria, Abdullah, Junaedib, and Aswidinnoorb (2011) mentioned there are aromatic paddy rice varieties in the Enrekang Regency such as Pinjan and Pulu Mandoti, and in the Toraja regencies such as Pare Bau and Lambau. According to a publication of the

Enrekang Regency's Statistic Bureau (2016), the Enrekang regency is located at 3°14'36" to 3°50'0" South Latitude and 119°40'53" to 120°6'33" East Longitude and its distance from Makassar, the capital city of the South Sulawesi province, is 235 km. Its elevation is from 442 to 3,000 m above the sea. The capital city of the Enrekang regency is the Enrekang city. According to a publication of the Tana Toraja Regency's Government (2016), the Tana Toraja regency is located at 2° to 3° South Latitude and 119° to 120° East Longitude and its distance from Makassar is 320 km. Its elevation is from 1,500 to 3,000 m above the sea. The capital city of the Tana Toraja regency is the Makale city. According to a publication of the North Toraja Regency's Government (2016), the North Toraja regency is located at 2°35' to 3°15' to South Latitude and 119° to 120° East Longitude and its distance from Makassar is 321 km. Its elevation is from 704 to 1,646 m above the sea. The capital city of the North Toraja regency is the Rantepao city.

Interview was done from 18 December 2015 to 18 January 2016. Responders for this field study were 17 farmers, 11 farmers were in the Enrekang regency, 4 farmers were in the North Toraja regency, and 2 farmers were in the Tana Toraja regency. At first, responders were obtained by informants who knew them. Then by using the snowball techniques, the first responders in each villages asked their friends or relatives to join the interviews. Interviews were held at the Balla village and the Bau village in the Enrekang regency, at the Minanga village in the Tana Toraja regency, and at the Buntu village, the Bolu village, the Tallunglipu village and at the Kampung Baru village in the North Toraja regency. The first responders in almost all villages had introduced me to other farmers inside their villages. There was only one responders who introduced me to another farmer outside his village, and there were two farmers who did not introduced me to another farmer. Farmers decided the dates and times for interviews. At first, interview was held at the Balla village in the Enrekang regency, then at the Buntu village in the North Toraja regency, then at the Minanga village in the Tana Toraja regency, then at the Bolu village in the North Toraja, then at the Tallunglipu village in the North Toraja regency, then at the Kampung Baru village in the North Toraja regency, then at the Bau village in the Enrekang regency. The interviews used a free style techniques which helped farmers to speak freely based on their experiences in the paddy rice production. Farmers were not easy to believe an outsider, so I promised a confidentiality for all responder's identities and any specific information in the interviews. The questions for interviews consisted of 6 topics; 1) about the continuity of the paddy rice production, 2) about farmers' cooperation to solve pests problems, 3) about farmers' cooperation to maintain agricultural infrastructures, 4) about production factors for a paddy rice production, 5) about a financial aspect for a paddy rice production, and 6) about marketing of paddy rice products. Farmers were asked to choose any topic in the list which they wanted to talk about. Talk was usually about their experience of production and related problems, mixing up many topics. Farmers talked mostly during interviews, and I interfered only

to clarify ambiguous comments by them. Those information were recorded using a voice recorder and a logbook.

Minimum quantitative data was taken to characterize interviewed farmers. Quantitative data is not used in the analysis. Those quantitative data were about the total size of their agricultural lands, a size of a part of agricultural land used as paddy rice fields, their current ages, and how long they have been working on the paddy rice production. Almost all of farmers interviewed were not small scale farmers. In the Enrekang Regency, the North Toraja regency and the Tana Toraja regency, all of interviewed farmers owned more than 1.5 ha of agricultural land. All interviewed farmers had enough experience on the agricultural production, who had been experienced more than 10 years of experience in the agricultural production. The least experienced farmer in the Enrekang regency had been working in the agricultural production for 18 years. The least experienced farmer in the Tana Toraja regency had been working in the agricultural production for 20 years. The least experienced farmer in the North Toraja regency had been working in the agricultural production for 33 years. All responders of the interviews managed a production of various agricultural products.

#### **4. The Role of A Paddy Rice Production in the Enrekang Regency**

In the Enrekang Regency, farmers use 0.2 to 1 hectare of their land for a paddy rice production, but because of a rotating land ownership system, farmers mentioned that they must wait for more than 2 years for their turn of production. Farmers can produce 7 to 8 tons of paddy rice in a hectare per year. At other lands, they produce corn and horticultures such as red onions, chili and potatoes at other lands. They also have cattles breded and some fish pools. In the dry season, farmers produce only agricultural products other than paddy rice. Farmers mentioned their income mostly comes from vegetable production of red onion, chili, potato and tomato. They also make revenues from corn and fish. Among all products, red onion contributes the most to their income. Although the current prices of local rice varieties of highlands are higher than the current prices of lowland rice varieties, it is not as high as those of other competitive commercial agricultural products. For an example, in the Enrekang regency, red onion productivity and pofitability is much higher than rice. Farmers mentioned red onion can be produced 3 times a year, while paddy rice production only once a year. They also mentioned a red onion production can produce about 20 tons in a hectare per year, while a paddy rice production produce about 6 tons. Farmers mentioned the current prices of local rice varieties of highlands are about Rp 14,000 per kilogram and the current prices of lowland rice varieties are about Rp 8,000 per kilogram. So there is no incentive for farmers to continue a paddy rice production for a commercial purpose. Mostly, the purpose of paddy rice production there is a self-consumption by the family. Sometimes, rice is sold when farmers need money for children education and health treatments.



At an area which is far from a river, paddy rice is still produced. Farmers mentioned, although a red onion production is the main source of income for them, farmers always produce a paddy rice after two consecutive productions of red onion. From their experience, they see that a continuous red onion production, three times in a year, would make a risk of worm pest on red onions which would require to apply a chemical pesticide. A production of paddy rice reduces a worm pest and farmer can save their money from buying pesticides. The paddy fields must be maintained by the current owner in a good condition for a next production. A paddy rice production can also prevent them from spending on rice for their consumption. Farmers mentioned they use both the government's paddy rice variety and that of upland variety alternately to maintain the productivity of both varieties. By their experiences, farmers realize that a continuous paddy rice production with only one varieties would corrupt paddy grains, which might reduce the weight of paddy grains, or even lead to empty grains. A bad harvest would harm farmers because it reduces paddy rice stock for a self-consumption and for sale. In the worst case, farmers have to buy rice produced by the lowland farmers to fulfill their consumption.

##### **5. The Role of A Paddy Rice Production in the Toraja Regencies**

In the North Toraja Regency, farmers use most of their land, 1 to 2 hectares, for a paddy rice production, while farmers in the Tana Toraja Regency use only 20% to 80% of their land. They can produce about 6 tons of paddy rice in a hectare. The rest of farmer's fields in the North Toraja is used for other agricultural production such as pig breeding, poultry, water buffalo breeding. They also work at a coffee plantation owned by a Japanese company. In the dry season they just concentrate on their cattles. The rest of farmer's land in the Tana Toraja is used for other agricultural production such as coffee plantation, clove plantation, pig breeding, poultry and water buffalo breeding. A landlord family who has 10 hectares land concentrates their effort on plantations. In the dry season farmers just concentrate on their plantations and their cattles.

In both Toraja regencies, farmers realize that a paddy rice production is not profitable and rice is no longer a competitive commercial agricultural product in upland. That rice is mostly for self-consumption of a family. In order to provide cash for children education and health treatments, farmers sold their rice stocks. Farmers mentioned the prices of local rice varieties of highlands are more expensive than the lowland rice varieties. They mentioned the price of the highland local rice varieties are about Rp 14,000 per kilogram and those of lowland rice varieties are about Rp 8,000 per kilogram currently. However, farmers also mentioned their attention to economic returns from other agricultural products than paddy rice. Farmers in the North Toraja Regency mentioned their income mostly comes from a water buffalo breeding and sales of fishes. Among all products, a water buffalo breeding contributes the most to their income. Farmers in the Tana Toraja Regency mentioned their income mostly comes from a water buffalo breeding, sales of fishes, poultry, coffee plantations

and clove plantations. Among all products, plantations and a water buffalo breeding contribute the most to their income. Although, a paddy rice production produce more than cloves production, cloves's price is much higher than paddy rice price. Coffee beans profitability are also higher than paddy rice, but its price is much higher than paddy rice price. Both cloves and coffee produce more profit than paddy rice and cost of producing them become so low since they need less pesticides, fertilizers and water than paddy rice. So there is no incentive for farmers to continue a paddy rice production for a commercial purpose. Mostly, the purpose of paddy rice production there is a self-consumption by the family. Farmers in both Toraja regencies mentioned water buffalo breeding could give a high economic return to a farmer since a lot of Torajan people would like to have some water buffaloes for their traditional ceremony. Farmers mentioned there is a custom in Toraja's societies to conduct the "Rambu Solok", a funeral ceremony for the deceased in their families, which presents a water buffalo fighting as a part of the ritual ceremony. The family of deceased also sacrifices other water buffaloes and serve them as a food in the ceremony. Their horns are placed at the top-front of their "Tongkonans", a set of a traditional house and paddy rice storages to manifest their family wealth. The fighter water buffaloes and the albino water buffaloes are in a very high demand and their prices are very high. The funeral ceremonies are conducted more often in the North Toraja than in the Tana Toraja. Farmers in the North Toraja mentioned a funeral ceremony is funded by all family members, but the big part of it comes from the family members who have a good job with a big income in the cities.

Farmers in the Toraja regencies mentioned agricultural land is owned by all members of a big family. The land is a important part of a family property combined with its Tongkonan. The share of land ownership is not distiributed equally. Farmers mentioned family members who have sacrificed a lot of water buffaloes in a "Rambu Solok" would hold more shares than other family members and each members of the family tries to sacrifie as many as he cans. Most of the big contributors are the family members who have a good job with a high salary in the big cities. Farmes mentioned if a family member has more shares, his pride in his big family and in the Torajan's societies would increase. Stabilizing a paddy rice production would secure the asset value for a big family and promote a pride of the family. Amount of paddy rice harvested is not important, as long as it is enough to be consumed by family members who maintain the paddy rice production and preserve the agricultural land. Paddy rice production is not important commercially, but it is a part of a family's real asset, and each member in a big family would like to share the real wealth from it.

## **6. Conclusion**

Farmers in the upland of South Sulawesi have a different way to see a role of paddy rice production. Farmers in Enrekang have put a focus on red onion productions as their most important commercial agricultural product. They keep

a paddy rice production as a pest control for a red onion production, and for their food insurance.

Farmers in Tana Toraja and North Toraja have a consideration on the ways of keeping their close family relationship in a big family. A paddy rice production has become an important part of their real asset and all family members will support the production to secure their dividends on it.

## REFERENCES

- AccuWeather (2016). *AccuWeather: Enrekang, Indonesia Cuaca*. Retrieved from <http://www.accuweather.com/id/id/enrekang/205767/daily-weather-forecast/205767>
- \_\_\_\_ (2016). *AccuWeather: Makale, Indonesia Cuaca*. Retrieved from <http://www.accuweather.com/id/id/makale/205729/daily-weather-forecast/205729>
- \_\_\_\_ (2016). *AccuWeather: Rantepao, Indonesia Cuaca*. Retrieved from <http://www.accuweather.com/id/id/rantepao/205782/daily-weather-forecast/205782>
- BPS Kabupaten Enrekang (2012). *Situs Resmi BPS Kabupaten Enrekang: Geografi dan Iklim*. Retrieved from [https://enrekangkab.bps.go.id/Ver1/index.php?page=articleview&kat=2&id\\_artikel=80](https://enrekangkab.bps.go.id/Ver1/index.php?page=articleview&kat=2&id_artikel=80)
- De Jong, E. (2013) *Making a Living between Crises and Ceremonies in Tana Toraja: The Practice of everyday Life of a South Sulawesi highland Community*. Leiden/Boston: Brill, 2013
- Harga.web.id (2016) *Prediksi Harga Cengkeh tahun 2016*. Retrieved from <http://harga.web.id/prediksi-harga-cengkeh-tahun-2016.info>
- Jitunews.com (2016). *Petani Sukses: Keberhasilan Hanya Diraih dengan Ketekunan*. Retrieved from <http://www.jitunews.com/read/2205/petani-sukses-keberhasilan-hanya-diraih-dengan-ketekunan>
- Kabupaten Enrekang (2016). *Situs Resmi Kabupaten Enrekang Provinsi Sulawesi Selatan: Enrekang Kabupaten Penghasil Bawang Merah di Sulawesi Selatan*. Retrieved from <http://ver2.enrekangkab.go.id/index.php/83-tulis/berita/380-enrekang-kabupaten-penghasil-bawang-merah-di-sulawesi-selatan>
- Kompas.Com (2016). *Kompas.com: Ekonomi*. <http://bisniskeuangan.kompas.com/read/2013/01/03/16462125/Ini.10.Provinsi.Penghasil.Beras.Tertinggi.di.Indonesia>
- Lestaria, A. P., Abdullah, B., Junaedib, A., Aswidinnoorb, H. (2011) *Performance of Grain Quality and Aroma of Aromatic New Plant Type Promising Rice Lines*. Retrieved from <http://pustaka.litbang.deptan.go.id/publikasi/as122115.pdf>

- Othervisions (2013) *Cengkeh yang Menghidupi*. Retrieved from <https://othervisions.wordpress.com/2013/08/17/cengkeh-yang-menghidupi/>
- Pemerintah Kabupaten Tana Toraja (2012). *Situs Resmi Pemerintah Kabupaten Tana Toraja: Letak Geografis*. Retrieved from <http://www.tanatorajakab.go.id/id/content/letak-geografis>
- Pemerintah Kabupaten Toraja Utara (2014). *Pemerintah Kabupaten Toraja Utara: Letak Geografis*. Retrieved from <http://www.torajautarakab.go.id/profil-daerah/letak-geografis.html>
- Tanimedia.com (2013) *Panen Buah Kopi*. Retrieved from <http://tanimedia.blogspot.jp/2013/01/panen-buah-kopi.html>
- TribunToraja.com (2016) *Inilah Jenis, Ciri, dan Harga Tedong di Toraja*. Retrieved from <http://makassar.tribunnews.com/2016/03/14/inilah-jenis-ciri-dan-harga-tedong-di-toraja?page=4>
- Veco Indonesia (2015) *Dan, Kopi dengan Nilai Tertinggi Diperoleh... Asnikom!* Retrieved from <https://indonesia.vecos-ngo.org/id/berita/dan-kopi-dengan-nilai-tertinggi-diperoleh-asnikom>

**Miscommunication in Japanese between Japanese and Local  
Employees  
in a Japanese-affiliated Company in China**

Yayoi Umemura

Chiba University

1-33, Yayoi-cho, Inage-ku, Chiba-shi, 263-8522, Japan

---

**Abstract**

According to the 42nd Survey of Overseas Business Activities by the Ministry of Economics, Trade, and Industry (METI) in 2013, almost 3,734 thousand people work in Japanese-affiliated companies in Asia. It has been well documented that corporate globalization increases communication conflicts among individuals from different cultural backgrounds. A considerable amount of quantitative and qualitative studies have been conducted to identify the source of the misunderstandings. However, fewer studies have analysed actual discussions at work.

This study focuses on the interaction between native and non-native speakers of Japanese, which was video-recorded during fieldwork at an anonymous Japanese-affiliated company in Suzhou, China. Using Japanese as a common language, the speakers communicate with each other about work. Based on a theoretical and methodological framework of conversation analysis this study attempts to explore what types of problems occur in their communication.

This paper presents several conversations. In some cases the employees recognize the emergence of problems and solve them successfully, but in other cases they fail to do so. In the latter cases, the interlocutor only partially understands what the speaker intends to communicate, and they are both unaware of the problems occurring in the on-going interaction. Solely acquiring advanced Japanese competence on the part of non-native employees will not completely resolve this problem. Along with such competence, cooperative communication training is also necessary to improve understanding between workers.

**Keywords**

**miscommunication, talk at work, conversation analysis, native and non-native speaker, Japanese-affiliated company**

**1. Introduction**

After China joined the World Trade Organization (WTO) in 2001, Japanese Foreign Direct Investment (FDA) surged into China, and by 2014, almost 6707 Japanese-affiliated companies\* had begun to operate in China (Mitsubishi Tokyo UFJ 2014). Recently, they have expanded their business in Association of South-East Asian Nations(ASEAN)countries because of high wages and economic stagnation in

---

\*This number contains the number of the companies which have already withdrawn.

China. Almost 6859 Japanese-affiliated companies have been running their operations in ASEAN countries; they have focused on the manufacturing industry because of the low production costs and the growing market in those countries<sup>†</sup>.

Globalization in the corporate world has increased problems in communication among employees who have different cultural backgrounds. In the study of business economics, numerous attempts have been made to show that the cultivation of human resources with high communicative proficiency is required and that globalized human resources are indeed the foundation for the development of globalization of business (Ferraro 1990; Earley and Mosakowsky 2000; Shiraki 2012; Yamamoto 2012). In the field of cross-cultural communication, researchers have investigated communication conflicts between employees in multinational companies (Allen 1995; Hofstede 2001; Nishida 2001, 2007). Furthermore, from the Japanese language education perspective, they have revealed that employees experience conflict when establishing mutual understanding and developing common recognition between Japanese and local employees in Japanese-affiliated companies. Those studies have defined the communication problems at work; in addition, some of them have given directions on how to break away from the conflict caused by misunderstanding (Kondo et al. 2009).

However, the above-mentioned studies have been conducted through surveys, namely, questionnaires and interviews. Only a few of the conducted studies have analyzed their communication at work by focusing on their linguistic context. The present study is based on the face-to-face interaction occurring between Japanese and Chinese employees. Their natural conversation at work was video recorded in an anonymous Japanese-affiliated company located in China, where local employees with elementary Japanese language skills are required to communicate with their Japanese colleagues in Japanese. A challenging language barrier exists in the company.

## **2. Purpose of this study**

In my data, some Chinese and Japanese employees recognized the emergence of trouble and solved it successfully; however, in some, they failed to do so. In the latter cases, the interlocutor's understanding was partially or totally different from what the speaker intended to communicate, and they were unaware of the trouble occurring in the on-going interaction.

This study investigated the conversations at work by focusing on the misunderstanding between Japanese and Chinese employees. In their talk-in-interaction, the place where the misunderstanding occurs and the process in which their problem is solved can be demonstrated through the procedure of conversation analysis. By clarifying the process of misunderstanding, its source can be revealed.

Because this study was a type of case study, it did not explore the source of miscommunication statistically, based on many cases. The segments presented in this study are ones from natural conversations that actually occurred during my fieldwork. Accordingly, the purpose of this study is neither to illustrate the general tendency nor to find the general pattern of the occurrence of miscommunication.

## **3. Background information of the field**

### *3.1 Fieldwork in PLA Company*

---

<sup>†</sup>This number contains the number of the companies which have already withdrawn.

The parent company of PLA Company (an anonymous name), which manufactures plastic parts, is a medium-sized company located in Japan. It has 11 factories in Japan and overseas of which PLA Company is one. Several Japanese employees are dispatched to each of the overseas factories as supervisor for production and management. Japanese employees communicate with local employees in Japanese in the overseas factories.

As a Japanese language teacher, I visited PLA Company five times from 2011 to 2013, where Japanese employees sometimes claimed that they often felt uneasy because they did not know whether Chinese employees understood what they intended. Japanese employees thought that to solve the Chinese employees' communication problems, it would be effective for the Chinese employees to learn Japanese and thus acquire the necessary communication skills.

### 3.2 Chinese employees in PLA Company

Out of the 372 Chinese employees in PLA Company, 20 could speak Japanese and played important roles in the company. Those 20 employees are divided into three groups: group (a), group (b), and group (c) as shown in Table 1.

Table 1: Job Title and Japanese Language Learning

Job Title	Number	Japanese Language Learning
(a) executive level	3	Graduated from Japanese University or technical school in Japan
(b) middle management level	15	Learned Japanese at night school in half or one year
(c) interpreter	2	Majored Japanese at university

Group (a): They possessed a high level of Japanese language proficiency and had considerable experience in working in the parent company in Japan. They supported PLA Company as executive-level employees.

Group (b): As they had been working at PLA Company for more than 10 years, they were versed in production of plastic parts. Even though their Japanese language proficiency was at a beginner or intermediate level<sup>‡</sup>, they were required to mediate and help both Japanese co-workers and Chinese workers understand each other to communicate the Japanese technique. They faced many communication problems while executing their duties.

Group (c): Although they majored in Japanese at universities, they could not interpret the Japanese employees correctly because of their little knowledge of plastic manufacturing. They were mainly in charge of translating official documents.

The communication between Chinese employees belonging to group (b) and Japanese employees was the focus of my research.

## 4. Data

In this section three segments of conversations between Japanese and Chinese employees are presented, in each of which miscommunication is occurred caused by Japanese employees.

### 4.1 Long TCU in utterance

In PLA Company they keep production for 24 hours. For night operation some workers are assigned to evening shift. Every morning they have meeting in order to share information about night time production. In the meeting held on one morning the night man reports that

<sup>‡</sup>They took a mock examination of a Japanese language proficiency test (JLPT) in August, 2010. Average percentage of achievement of the middle management employees was 52.4 %. The latter indicates that their Japanese language proficiency was at an intermediate level.

the defective production occurred and he only reports the number of the part and numerical quantity of defection. After meeting the Director of Manufacturing Division, Japanese employee (J1) claims against Vice Manager, Chinese employee (C1) that when defective production occurred, not only the name and numerous quantities but also more detailed information like the lots number<sup>§</sup> and supposed reason of defection is required to explain. He commands the Vice Manager that he has to tell leaders of each section to give more detailed information in the meeting. J1 told C1 as follows.

**【segment 1】**

- 01J1: → ですから(0.2) そこらへんは まず: (.) ひとつは ストップかけるのが ひとつ  
Then, what should do first is to stop the production.
- 02 → 第1番目に 必要なこと だろうけど: (.) あれは 各ポジションのね(.) リ  
ーダーさん  
→ That is most important one they should do. Leaders of each section  
should know
- 03 → 係長さんが (.) そこらへんね (.) よく理解して(.) あのストップかけたか  
それに対して  
that the machine stopped immediately and also
- 04 → どういうロットの範囲があったか ある程度のおおむねの原因をね (.)  
they should confirm that how many lots have trouble and what reason  
can be supposed for
- 05 → あのあそこの朝来る時点で: みなさんが 把握していないと (.) あそこに  
the defective production. Before attending the meeting they should  
grasp those
- 06 → 議論 成り立たないんですよ.  
points. Then we can discuss on that trouble which happened at night  
time production.
- 07C1: .hh そうですね: あの.: hh 実は 今朝の劉係長の話によると: まあ: 前回  
は: 確かに バリも  
Well. According to Mr. Ryu the defection caused by burr happened  
before <<omitted>>
- 08 発生しました. <<省略>>
- 09C1 わかりました.  
OK. I understand.

In the above segment the utterance of J1 is composed of six clauses. In Japanese language, we generally use clause chaining (Ono & Iwasaki 2002) in one TCU<sup>\*\*</sup>(Sacks, Schegloff and Jefferson 1974). By use of clause chaining we utilize many function, increment of information, reformulation of sentence construction, interpolation, bridging and local management (Ono & Iwasaki 2002). It is quite natural for Japanese to go on conversation forward by chaining many clauses in one TCU. However since the talk of J1 contains various information, it seems difficult for non-native speaker C1 to grasp what was required to command. In line 07 C1 begins to explain the cause of previous defection of the same mold of the machine. Actually C1 does not comprehend J1's talk, even though C1 responds with "Well", in Japanese "Soudesune" which is affirmative response to previous utterance. After his explanation J1 repeats his direction in more concise way, then C1 understands what he should do. It took long time to attain to the point of J1's direction. As a result it causes long delay of understanding.

*4.2 Difficult expression in Japanese utterance*

<sup>§</sup> Productive unit which is divided in the time of continuous production.

<sup>\*\*</sup> TCU is abbreviation of Turn Construction Unit, which is unit of smallest unit the utterance in the situation where the utterance is produced.



In the following segment J2 (Japanese employee) uses the form of negative question. In linguistics this type of language format is called Reversed-Polarity-Question (RPQ), which express reversed polarity to the polarity of the used form (Koshik 2005). It means that even though the speaker uses negative form, he or she delivers the affirmative meaning. In the following segment J2 offers suggestion C2 to make appointment with the client to meet in the afternoon. Because, however the format of his suggestion is negative form, C2 comprehend that he was suggested to have meeting in the morning.

**【segment 2】**

01 J1: 一番いいのはね(.) ヤマノさんが時間取れるのであれば: 午後1時半とかいう時間帯

The best time is in the afternoon 1:30, if Yamano has time to meet.

02 → の方がいいと思わない?

Don't you think that it is good to set appoint, one thirty in the afternoon.

The listener of this suggestion, C2 responds, "I understand." After hearing C2's response, J2 begins to explain why afternoon time is preferable. During his explanation C2 feels embarrassment because C2 understands that it is not good to set time one thirty in the afternoon. The intonation of J1's question is slightly climbing up. C2 understands that J2 says "I don't think that you set time one thirty in the afternoon." By making interview and asking C2 whether he understands RPQ in this conversation. The author founds that C2 actually misunderstands what J1 means.

*4.3 Repeated sentence by the Japanese employee*

To understand the following segment you should know background information on metal mold for plastic parts. For the production of plastic parts they make metal molds. During the mass production of plastic parts, metal molds frequently break and must be repaired immediately. In order to meet the deadlines to deliver the products to customers, they have to be fixed promptly. From ten to fifteen metal molds are repaired every week at PLA Company.

C3 is in charge of managing the metal mold repair. She accepts repair request from manufacturing section and then she evaluates the level of repair. When relatively easier repair case, C3 asks Maintenance Division to fix and when relatively difficult repair case, C3 asks Technical Division to fix. In the following conversation, they were talking about a certain metal mold, temporarily we call the name of which Mold X which is to be fixed in Maintenance Division. J3 wanted to know the situation of a certain mold which Maintenance Division was asked to fix. Because all of the mold in this company are made in C3's Division, he has to grasp the process of repair of all the metal molds in the company.

**【segment 3】**

01 J3:→まっ 金型保全に: 修理を頼んだんです

OK. So the Maintenance Division was asked to fix.

02 けど: (0.2) 金型保全は 修理したん ですか↓ね

Has the Maintenance Division already fixed?

03 (0.4)

04 C3:→もう修理 しましたか?

Have they fixed?

05 J3:→はい (0.2) 修理 し[たんですか [金型保全は



verbal exchanges at work. They are unaware of their mistakes and the unintelligible expressions they make, which cause miscommunication.

In PLA Company, the learning program was proposed in which Japanese employees and Chinese employees learn collaboratively to lessen the language burden of the Chinese employees (Umemura 2012). In that program, they have a chance for feedback of their face-to-face communication by watching their own video recorded conversations and the transcription of conversation. Both Chinese and Japanese employees reflect together and discuss the problems straightforwardly.

Solely acquiring advanced Japanese competence on the part of non-native employees will not completely resolve this problem. Along with such competence, cooperative communication training is also necessary to improve understanding between workers.

## References

- Allen, M.W. (1995). Communication concepts related to perceived organizational support. *Western Journal of Communication*. 59, 4, 326-347.
- Mitsubishi Tokyo UFJ (2014). *Global Business Handbook for Asia*. Toyo Keizai Shinposha.
- Earley, P. Christopher and Mosakowski, Elaine ( 2000 ) “Creating Hybrid Team Cultures: An Empirical Test of Transnational Team Functioning” *Academy of Management Journal*, Vol.43, No.1, 26–49.
- Ferraro, G. P. (1990). *The Cultural Dimension of International Business*. Prentice Hall Inc.
- Hofstede, G. (2001). *Culture’s consequences: Comparing values, behaviors, institutions, and organizations across nations*. Thousand Oaks, CA: Sage Publications.
- Koshik, Irene.(2005). *Beyond Rhetorical Questions*. Philadelphia : John Benjamins Publishing  
compsmJohn
- Nishida, H. (2001). *Malasya · Philippin shinshutsu nikkeikigyo niokeru ibunka komyunikeishon*. [Cross-cultural Communication in Japanese-affiliated Companies in Malaysia and Philippine]. Tagashuppan. [in Japanese]
- Nishida, H. (2007). *Beikoku · Chugoku shinshutsu nikkeikigyo niokeru ibunka komyunikeishon*. [ Cross-Cultural Communication in Japanese-affiliated Companies the United States of America and China]. Kazamashobo. [in Japanese]
- Ono, T & Iwasaki, S.(2002). ‘Sentence ’ in Spoken Japanese Discourse. In *Culture, Interaction and Language*. Kataoka, K. & Ide, S. (eds. ). Hitsujishobo.
- Sacks,Harvey , Schegloff, Emanuel A. and Jehherson, Gail (1974). The simplest systematics for the organization of turn-taking for conversation. *Language*,50(4), Pp.696-735.
- Schegloff, E. A.,Jefferson, G. & Sacks, H. 1977. The Preference for Self- Correction in the Organization of Repair in Conversation. *Language* 53(2).361-382
- Shiraki, M(2012). *Nihonkigyo no gurobarizeshon to kaigai hakensha*. [Glovalization of

Japanese Company and Dispatched Employees]. Nihonroudoukenkyuzasshi.

No.623,pp.5-16. [in Japanese]

Umemura, Y(2012). Zaichugoku kigyoniokeru chugokujinshainto nihonjinshainniyoru  
kyodoutekigakushuno jissen. (A Practical Report on a Collaborative Learning Program  
for Japanese and Chinese employees of a Japanese- affiliated Company in China).

Nihongokyoiku Jissenforamu houkoku. Nihongokyoikugakkai. [in Japanese]

Yamamoto, I. (2012). ASEAN nikkeikigyo no ginoukei jinzaikusei to rokaru kontekisuto  
[Development of Human Resources in Japanese- Affiliated Companies in ASEAN and  
Local Context]. Nihonroudoukenkyuzasshi. No.623, pp.37-48. [in Japanese]

**Topic :** Education

**Comparative Study On The Learning Styles (Visual, Auditory,  
And Kinesthetic) Towards Vocabulary Mastery**

M. Zainal Arifin, M.Hum.<sup>a</sup>, Norma Yuwanti<sup>1</sup>

*<sup>a</sup>Vice Dean of General Administrative and Planning, Faculty of Islamic Economics and Business, State Islamic Institute (IAIN) of Palangka Raya, Jl. G. Obos Komplek Islamic Center No. 24, Palangka Raya 73112, Indonesia*

---

**Abstract**

The writer has chosen the learning style to master vocabulary to find the comparison the learning style in the student's vocabulary score. The type of study was Expose-Facto research and the writer used quantitative approach in finding out the answer of the problem of study. In taking sample, the writer used proportional cluster random sampling. The collected data were taken from questionnaire, test, and documentation. The writer used t-test calculation with manual and SPSS 21.0 calculation to test hypothesis. The result of t-test with SPSS 21.0 calculation found the calculated value ( $t_{observed}$ ) was greater than  $t_{table}$  at 1% and 5% significance level or  $2.00 < 6.898 > 2.66$ . It was interpreted that alternative hypothesis ( $H_a$ ) stated that there was significant difference between means of variables was accepted and null hypothesis ( $H_0$ ) stated that there was no significant difference means of variables was rejected. It meant there was significant difference between the result of learning style's class A in mastering vocabulary and learning style's class B in mastering vocabulary.

**Keywords**

Vocabulary, Learning Style.

---

---

<sup>1</sup> Telp. Fax: +62 536 3222105.  
Phone: +62 85651387908

# **Comparative Study On The Learning Styles (Visual, Auditory, And Kinesthetic) Towards Vocabulary Mastery**

## **1. Preface**

There are many ways in teaching and learning English as a solution for teachers to teach the students. Exactly, the teacher usually uses the easiest and simplest way in teaching and learning process. In the classroom, teacher usually gives simple words through the understanding students' learning styles to give an alternative ways of teaching and learning process. If we wish to think and communicate more effectively, we must increase our vocabulary and improve your word using skill. There are many methods in improving vocabulary such as, by using pictures, songs or radio, games, etc. The best way to develop rich vocabulary is to have reach experiences travel, going to movies, plays, and concerts, seeing things, meeting people, listening to good conversation, and selecting going television broadcast.<sup>2</sup>

Multiple intelligence theory told by Howard Gardener remind the teacher about student owning type learn different. The learning styles as a the best way for teaching vocabulary, if the teacher uses the learning styles of each students will help students to acquiring the vocabulary. The students will be easy to comprehend knowledge if they learn through their learning style and the teacher have to know the students' learning style to help the students be easy in learning process. They choose and decide the best way to process the information in order it can be easy to learn. Learning style is a best way that they use to learn language. It helps students learn more fast and easier with selecting and using appropriate learning style.

Learning styles represent the best way to assist the student remember and the study the new information. Learning style for studying not only for studying is important because it can for developing their skill and interest, and improving the learning output. Learning style can be used to learn language by the students, including English. The

---

<sup>2</sup>Nana Sujana, *Metode Statistika : The world book student hand book*, Chicago: Child craft international, Inc, 1978, p. 82.

students can prefer learning style that is suitable for them to learn and practice English by themselves. The teachers have to understand what is the student's learning style order to easier in vocabulary mastery. Then, it also can comprehensible by the students, simple, and easy, and of the course if we change at the certain time so that still up to date and it doesn't make the student bored.

## **2. Review Of Related Literature**

### **a. Definition of Learning Style**

Learning style is the way and technique that use to learn information and knowledge. Students can learn more fast and easier with selecting and using the appropriate learning style that they like. Learning style refer to the variations in your ability to accumulate as well as assimilate information. Brown defines learning style as the manner in which individuals perceive and process information in learning situation.<sup>3</sup>

Brown defines learning style as the manner or way in which individuals perceive and process information in learning situations. Keefe says learning style might be as thought of as "cognitive, affective, and physiological trails that are relatively stable indicators of how learners perceive, interact with, and respond to the learning environment."<sup>4</sup>

According to Dunn, learning style is the way students begin to concentrate on, process, internalize, and remember new and difficult academic information.<sup>5</sup>

Basically, learning styles are divided into three part, they are as follows:

- 1) Visual Style (Visual Learner), visual learners tend to prefer reading and studying charts, drawing, and other graphic information.<sup>6</sup> The students who fall into this category learn what they are able to see with their own eyes.

---

<sup>3</sup> *Ibid*, P. 114

<sup>4</sup> *Ibid*, P. 114

<sup>5</sup> Rita Dunn, and Shirley A Griggs, *Practical Approach to Using Learning Style in Higher Education*, English: Library Congres Cataloging in-Publication Data, 2000, p.8

<sup>6</sup> *Ibid*, P. 129

They tendency learn to describe everything that they see in terms of appearances. Visual learners frequently are good writers and will commonly perform quite well on written assignment. Visual style has some characteristics, they are:<sup>7</sup> a) students can speak fast, ; b) students are good at spelling, ; c) students strong to remember what they see than they hear, ; d) students use pictures and notes aids to memorize or process some information and knowledge, ; e) students have difficulties to remember verbal instruction, ; f) prefer to read and write than listen dan ; g) they prefer art than music.

There are some learning strategies for visual style (visual learner), these are:

- 1) For work sheet, make a bold line around the items, to help the learners follow an item when they like it.
  - 2) Write the guidance on white or blackboard.
  - 3) Use graphic, charts, pictures, map, or colors.
  - 4) Let the learners point if it's needed, let them point the word or sentence when reading.
  - 5) Use mind-mapping to process information..
- 2) Auditory Style (Auditory Learner). Brown says that auditory learners prefer listening to lectures and audiotapes.<sup>8</sup> Auditory style is learning where learner or students are very good in listening. They tend to absorb information in a more efficient manner through sounds, music, discussion, teaching, etc. These individuals will be more likely to record lectures to that they can replay them at a later time for study purposes. Auditory learners appreciate books on tape and may find that reading aloud will help them to

---

<sup>7</sup>Bobbi DePorter, and Mike Hernacki, *Quantum Learning "Membiasakan Belajar Nyaman dan Menyenangkan"*, Bandung: PT. MizanPustaka, 2003, P. 116

<sup>8</sup>H. Brown Douglas, *Principles of language Learning and Teaching fourth edition*, New York: Longman, Inc, 2000, P. 129



retain information. Rather than written reports, auditory learners tend do better on oral presentation and reports.

The best ways for auditory learner to process the information by telling the information loudly, listening the voice recording, discussing with friends or learning group, recording an argument or statement, doing interview, teaching someone or people, and leading with others. Auditory style has some characteristic, they are:<sup>9</sup>

- 1) Students/learners like talking much, discussing, and explaining information lengthily.
- 2) Students feel difficult when they have to write the information but they are smart in explaining it.
- 3) Students like repeating and imitating a tone, rhythm, music, voice, or sound.
- 4) Students love music
- 5) Students are not afraid speaking in a class
- 6) Students can to remember learning in verbal instruction.

There are some learning strategies for auditory style (auditory learner), those are:

- 1) Let them repeat the information loudly.
- 2) Convert writing information into voice information (song, recording, etc)
- 3) Play background music when they learn
- 4) Play many rhythmical and united games when learning
- 5) Make group discussion

---

<sup>9</sup>Bobbi DePorter, and Mike Hernacki, *Quantum Learnin "Membiasakan Belajar Nyaman dan Menyenangkan*, Bandung: PT. MizanPustaka, 2003, P. 118

- 3) Kinesthetic Style (Kinesthetic Learner). Kinesthetic learner will show a preference for demonstrations and physical activity involving body movement.<sup>10</sup>Kinesthetic style is where students or learners to do tactile learning. This means that they learn well through moving, doing, acting out and touching. Kinesthetic learners tend to become frustrated when they must sit for long periods of time. They enjoy conducting experiments, exploring and performing tasks.

Kinesthetic learner has some characteristics, those are:<sup>11</sup>

- 1) Learners or students always move-that's way learner or students learn.
- 2) They move their body when they memorizing information like walking around.
- 3) They use fingers to point out the writing in a book when they read.
- 4) They cannot silently in long time.
- 5) They talk slowly and usually stand up near someone when talking.
- 6) Students prefer learning through practice and physic activities.
- 7) They want to do anything and love games.
- 8) They need concrete object as learning aids.

There are some learning strategies for kinesthetic style (kinesthetic learning), they are:

- 1) Use role play games as learning.
- 2) They do memorizing by walking around and see.
- 3) Show them how to do something.
- 4) Give silent activities after moving activities (example: reading text loudly after physic training at school).

---

<sup>10</sup>H. Brown Douglas, *Principles of language Learning and Teaching fourth edition*, New York: Longman, Inc, 2000, P. 129

<sup>11</sup>Bobbi DePorter, and Mike Hernacki, *Quantum Learning "Membiasakan Belajar Nyaman dan Menyenangkan"*, Bandung: PT. MizanPustaka, 2003, P. 118

## **b. The Nature of Vocabulary**

About vocabulary, there are some definition, Hatch and Brocun state that the term of vocabulary is a list or a set of words for a particular language or a list or a set of words that individual teacher of language might use. Vocabulary is all the words, usually arranged alphabetically and defined, explain or translate or the range of language, the stock of word at a person's command or used in particular work, branch or subject, language, etc. A vocabulary usually develops with age, and serves as a useful and fundamental tool for communication and acquiring knowledge.<sup>12</sup>

Talking about the vocabulary is needed to develop English language in process mastering it. Vocabulary is like way to learn new language. Language is combined by word.

According to Hornby, the word "vocabulary" is defined as follows:

1. The total number of words in language.
2. All the words known to a person or used in a particular book, subject, etc.
3. A list of words with their meanings, especially one that accompanies a textbook in a foreign language.<sup>13</sup>

Vocabulary is very important to be learned, because the students communicate with other students. If they have enough vocabulary to speak they can misunderstanding what about will be spoke.

## **c. Aspects of Learning Vocabulary**

In English of the words are classified into eight part. They are known as the eight parts of speech. The parts of speech are consisted of.<sup>14</sup> That based on the subject profile of vocabulary used the teacher. In the subject profile of vocabulary contents some core materials that are thought by the teacher to the

---

<sup>12</sup>Elfrida H. Hiebert and Michael L. Kamil, *Teaching And Learning Vocabulary*, New Jersey: Lawrence Elbaum Associates, 2005, P. 7

<sup>13</sup>Hornby, *Oxford Advanced Learner's Dictionary of Current English*, oxford university pers,1995,p.1331.

<sup>14</sup>FuadMas'ud, *Essential of English Grammar: a partical guide*, Yogyakarta: BPFE, 2005, P. 44-16

students as follow related there are many kinds of vocabulary that should be comprehend by the teachers before giving it to the students. Summarizing many kinds of vocabulary elaborated. According Thorn burry (2002) vocabulary is divided into:

**a) Word Classes**

Word classes are well-known as parts of speech in grammatical English. They include: noun, countable noun can usually be made plural by the addition of *-s/es*. uncountable noun, proper noun, common noun, verb, action verb, phrasal verb, adjective, adverb, pronoun, preposition, and conjunction. Example of word classes.

Auxiliary verbs	Verbs that support the main verbs	Am, are, has, could, should
Pronoun	Words that replace nouns	I, it, we, they, he, she
Nouns	People, place, things, and ideas	Patty, Seattle, cars, happiness
Main verbs	Verbs without auxiliaries	Run, swim, thinks
Adjectives	Words that describe nouns	Red, soft, careful
Adverbs (except adverbs of frequency)	Words that describe nouns	Calmly, quickly, carefully

**b) Word Families**

Thornbury says that how words may share the same base of root, but take different endings. A word that result from addition of an affix to a root, and which has different meaning from the root, it is called derivative. For example: player, playful, replay are each derivate of play. Thus, inflexions and derivate are both formed by the process of affixation. Affixes consist of suffixes such as *-full* ends of a word. Moreover, there are prefixes such as *re-*, *un-*, *pre* in the beginning of word.

1. Derivational Suffixes usually change part of speech of the word to which they are added.

Example:    Happy            - *adjective*  
                  Happily         - *adverb*  
                  Happiness      - *noun*

2. Derivational suffixes usually do not close off a word. After derivational suffix you can add derivational suffix.

Example: Fertile, Fertilize, Fertilizer

3. The word with derivational suffixes combined is an arbitrary matter.

Example: Failure

### **c) Word Meaning**

Word meaning are synonyms, antonym, and homonym is a word that shares same form but has unrelated meaning. Example: Well, left, fair.

### **d. Vocabulary Mastery**

Mastery comes from “master” that means to gain knowledge, to get the better of, and to train to live with and be of use to human. In Oxford Advanced Learners Dictionary is defined that “mastery is to complete knowledge, great skill, achieve/attain mastery of several language or show complete mastery in one’s handling of a difficult situation”.<sup>15</sup> Vocabulary mastery means the power to control, command, decide, and rule the vocabulary as a useful and fundamental tool for communication and acquiring knowledge.

Vocabulary mastery is one component to master English as foreign language. In learning four skills in language (listening, speaking, reading, and writing), vocabulary is very important to master by learners or students. It is reasonable remembering that four language skills need knowledge of words because they will get nothing without words or vocabulary.

---

<sup>15</sup>Hornby As, *Oxford Advanced Learners’ Dictionary*, Oxford: Oxford University Press, 2004, p. 721.

Learning language practically always means primarily learning the words of the language. Sometimes, it is useful to assess the size of a learners' vocabulary. One way to measure is to use a dictionary and choose the random selection of words and incorporate these into a test. Without testing there is no reliable means of knowing effective a teaching sequence has been.

All the teachers' language ought to see the growth or develop of that vocabulary as conceptual growth of conception or growth. Development of vocabulary has more than addition of new vocabulary into exchequer of new better in concept into formation. Change vocabulary meant to change life: to change your vocabulary is to change your life. One of fundamentals duty growth of vocabulary by the teachers helps all the students to see difference and equation. Which they are never seeing all the teachers have to strive by exploiting is multifarious technique of growth of word.

In this study, writers used the quantitative approach. The design of this study was non-experimental design because the writer want to measure the different significant on learning style in the teaching learning English vocabulary process. The larger group about which the generalization is made called a *population*. A population is defined as all members of any well-defined class of people, events, or objects.<sup>16</sup> The number of population is about 398 students of SMK N 1 Palangka Raya. The number of sample was 80 students.

A test was an instrument or procedure design to acquire performance from learners with the purpose of measuring their attainment specified criteria. Tests can be useful devices among other procedures and tasks designed to assess students.<sup>17</sup> In the study, the writer used some procedures to collect the data.

---

<sup>16</sup>DonalAry, Lucy Cheser Jacobs, Chris Sorensen, and AsgharRazavieh, *Introduction to Research in Education Eight edition,2010* p. 148.

<sup>17</sup> H. Douglas Brown, *Teaching by Principles an Interactive Approach to Language Pedagogy (Second Edition)*, p. 402.

The procedures would describe as follows: observation, questionnaire, and documentation. The data was very important for this study. They helped the writer in order to find aims of the study. Instrument was also as a tool for writer to collecting data. They were to measure the different significant on learning styles (visual, auditory, and kinesthetic) towards vocabulary mastery at the tenth grade of SMK N 1 Palangka Raya. The writer used the test and questionnaire as instrument for this research. In order to prove the tests were suitable to the students who are the sample of this study, the writer would be conducting try out test. Then writers have chosen students in the same school but different class to try out test. The try out test was conducted to class C of the sample of tenth grade students of SMK N 1 Palangka Raya.

In this study, the writer used the students' learning style questionnaire and multiple - choice checked students' vocabulary mastery. Therefore, the writer used multiple - choice that consisted of 45 items. If the result was valid, it means that the test items as instrumentation of this study are suitable to be given. In order to find out the description of how well the individual student has mastery the vocabulary, the final scores are related to the following qualification:<sup>18</sup>

**Table 3.4**  
**The Standard of Evaluation**

Score	Criteria
70-100	Mastery
<69	Fall

### **3. The Result of Data Analysis**

---

<sup>18</sup>Based on KKM at SMK N 1 Palangka Raya

The writers applied SPSS 21.0 program to calculate t-test in testing hypothesis of the study. The result of t-test using SPSS 21.0 was used to support the manual calculation of the t-test. The result of the test using SPSS program 21.0 could be seen as follows:

**Table 4.33**

**The Standard Deviation and the Standard Error of  $X_1$  and  $X_2$**

**Using SPSS 21.0 Program**

**Group Statistics**

	CLASS	N	Mean	Std. Deviation	Std. Error Mean
SCORE	1.00	40	87.6750	11.40487	1.80327
	2.00	40	70.0750	12.19371	1.92799

The table showed the result of the standard deviation calculation of  $X_1$  was 11,404878 and the result of the standard error mean calculation was 1,80327. The result of the standard deviation calculation of  $X_2$  was 12,19371 and the standard error mean calculation was 1,92799.

**Table 4.34**

**The Calculation of T-test Using SPSS 21.0**

**Independent Samples Test**

Levene's Test for Equality of Variances		t-test for Equality of Means						
F	Sig.	T	Df	Sig. (2-tailed)	Mean Difference	Std. Error Difference	95% Confidence Interval of the Difference	
							Lower	Upper



SCORER E	Equal variances assumed	.116	.734	6.667	78	.000	17.60000	2.63988	12.34441	22.85559
	Equal variances not assumed			6.667	77.654	.000	17.60000	2.63988	12.34404	22.85596

The table showed the result of t-test calculating using SPSS 21.0 program. Since the result of Class A and Class B had difference score of variance, it meant the t-test calculation used at the equal variances not assumed. It found that the result of  $t_{observed}$  was 6,667, the result of mean difference between class A and class B was the standard error difference between class A and class B was 2,63988.

**a. Interpretation**

To examine the truth or the false null hypothesis stating that there are difference students' learning style in class A and class B toward vocabulary mastery, the result of t-test was interpreted on the result of degree of freedom to get the  $t_{table}$ . The result of degree of freedom (df) was 78/60, it found from the total number of the students in both class minus 2. The following table was the result of  $t_{observed}$  and  $t_{table}$  from df at the 5% and 1% significance level.

**Table 4.35**  
**The Result of T-test Using SPSS 21.0**

Variable	T observed	T table	Df/db
----------	------------	---------	-------

		<b>5%</b>	<b>1%</b>	
<b>X<sub>1</sub>.X<sub>2</sub></b>	<b>6,667</b>	<b>2.00</b>	<b>2.66</b>	<b>78</b>

Interpretation of the result of t-test using SPSS program, it was found the t-observe was greater than the t-table at 1% and 5% significance level or  $2.00 < 6,667 > 2.66$ . It means that  $H_a$  was accepted and  $H_o$  is rejected.

It could be interpreted based on the result or calculation that  $H_a$  stating that there is significant difference on learning style (visual, auditory, and kinesthetic) towards vocabulary mastery of the tenth grade students of SMK N 1 Palangka Raya is accepted and  $H_o$  stating that there is no significant difference on learning style (visual, auditory, and kinesthetic) towards vocabulary mastery of the tenth grade students of SMK N 1 Palangka Raya is rejected.

#### **b. Discussion**

The result of data analysis showed that the questionnaire in chapter IV to identifying student's learning style towards vocabulary mastery of tenth grade students of SMK N 1 Palangka Raya. From the questionnaire was found that students' visual style or visual learner is 45 students that 30 students of class A and 15 students of class B, students' auditory style or auditory learner is 5 students' that 14 students of class B and 5 students of class A, students' kinesthetic style or kinesthetic learner is 19 students' who 2 students of class A and 11 students of class B, and 3 students have multiple learning style of class A. Most of the tenth grade students of SMK N 1 Palangka Raya are visual learner in mastering vocabulary. It can be seen the percentage of visual learner is 56,25%, auditory learner is 23,75%, kinesthetic learner is 16,25%, and multiple learner 3,75%. Most of the tenth grade students of SMK N 1 Palangka Raya are visual learner in mastering vocabulary. In the chapter II at the page 15, according to Dunn, visual learners tend to prefer reading and studying charts, drawing, and other graphic information. The students strong to remember what they see than they hear. The students who have

multiple learning styles got the high score in the first and second test. Then, in the chapter II at the page 16, Brown says that auditory learners prefer listening to lectures and audiotapes. And kinesthetic learner will show a preference for demonstration and physical activity involving body movement. It could be shown from the previous study in the chapter II at the page 13 a study entitled "The Influence of Learning Styles (Visual, Auditory, and kinesthetic) towards vocabulary mastery at the second year students of MAN Salatiga in the Academic year of 2012-2013" by Nur Khafidudin that the research said there were influence learning style towards vocabulary mastery.

The result of data analysis showed that there was significant difference learning style towards vocabulary mastery of the tenth grade students of SMK N 1 Palangka Raya. The students of class A who have the highest on the visual style in second test with mean score (88) than those students of class B who have both learning style in second test with mean score (70). Moreover, after the data calculated using T-test with level 5% of significant. It was found that  $t_{\text{observed}}$  was higher than  $t_{\text{table}}$ .

The students, learning style of class A have significant difference on vocabulary mastery than class B at the tenth grade students of SMK N 1 Palangka Raya. It can be seen first from the vocabulary score of class A and class B  $2.00 < 6,89819 > 2.66$ . It indicated that there is significant difference on the learning style of class A and Class B towards vocabulary mastery of the tenth grade students of SMK N 1 Palangka Raya. Meanwhile, after the data were calculated using  $t_{\text{test}}$  formula using manual calculation showed that  $t_{\text{observed}}$  was 6,89819. By comparing the  $t_{\text{observed}}$  with the  $t_{\text{table}}$ . It was found that  $t_{\text{observed}}$  was higher than the value of  $t_{\text{table}}$  at 1% and 5% significance level or  $2.00 < 6,89819 > 2.66$ .

It could be concluded there was significant difference of score at the first test and the second test. In the first test meeting, the students gave the first test was not depending of their learning style. The students answered all of learning style item. In the second test meeting, the students gave the second test was depending their learning

style. The students answered the item based on their learning style. The result showed that the students' score of the first test have the mean score (class A 70 class B 58). Then, the students' score have difference when they answered the test based on their learning style. The results showed that the students' score of the second test have the mean score (class A 88 and class B 70). In the chapter II page 14, Brown defines that learning styles as the manner in which individuals perceive and process information in learning situation.

The result supported by theory about the learning style is a way to students to learn English. There are some reason how the learning style can give the way to students' vocabulary mastery, that are about the learning style in learning process, such as the students' will be more interesting to learn, the students will be easy to comprehend knowledge based on their learning style, the teacher will be more easy to teach the students if the teacher know the students' learning style.

Other reason was in teaching learning process, the technique or the style is the best way for teaching vocabulary. DePorter said "Learning style is the way and technique that is used to learn information and knowledge. DePorter said "Learning style is the way and technique that is used to learn information and knowledge. It helps students learn more fast and easier with selecting and using the appropriate learning style that they like". It could be shown how the learning style gives the best way towards vocabulary mastery of the tenth grade students of SMK N 1 Palangka Raya. Based on the result, the visual learner had the highest score towards vocabulary mastery and auditory learner had the lowest score towards vocabulary mastery. The students will be enjoying in learning process if they can remember the vocabulary with their learning style.

In this case, the writer did not found problems when conducting the study in giving the questionnaire and instrument test to the students, because the students still like to study together.

#### 4. Conclusion

Based on the data obtained from the scores of vocabulary mastery test, it could be answered the problem of the study which "Is there significant different on learning style (visual, auditory, and kinesthetic) towards vocabulary mastery of the tenth grade students of SMK N 1 Palangka Raya?". It could be answered by testing data analysis. Based on the obtained, the result showed that the mean score of class A of the tenth grade students of SMK N 1 Palangka Raya in mastering vocabulary in the second test was 88 that was increase from the first test with mean score of 70,1. It proven there was significant effect of learning styles towards vocabulary mastery of the tenth grade students of SMK N 1 Palangka Raya. While the mean score of class B of SMK N 1 Palangka Raya in mastering vocabulary in the second test was 70 that was increase from the first test with mean score of 66. It proven there was significant effect of learning styles towards vocabulary mastery of the tenth grade students of SMK N 1 Palangka Raya. From both means, there was different value that 18. It meant that there was different learning style of them in mastering vocabulary. The result of hypothesis test, the value of t from the test result calculation for  $t_{\text{observed}}$  was 6,89819. The level of significant (5%) and (1%) with df or db  $(N_1+N_2)-2 = (40+40)-2 = 78$ ,  $t_{\text{table}}$  was 2.00 and 2.66. Since the  $t_{\text{observed}} > t_{\text{table}} = 6,89819 > 2.00$ . Because  $t_{\text{observed}}$  from the result was higher than  $t_{\text{table}}$ , so  $H_a$  was accepted and  $H_o$  is rejected. It meant there is significant difference on the learning style towards vocabulary mastery of the tenth grade students of SMK N 1 Palangka Raya. The difference of problem that students of class A and class B in mastering vocabulary are: (1) The students of class A of SMK N 1 Palangka Raya have the higher visual style consist of 30 students, auditory style consists of 5 students, kinesthetic style consists of 2 students, and multiple style consist of 3 students. (2) The mean score of learning style of class A was 88. The students of class B of SMK N 1 Palangka Raya have visual style consist of 15 students, auditory style consists of 14

students, kinesthetic style consists of 11 students, and there was no multiple style students. The mean score of learning style of class A was 70.

## REFERENCE

- Ary Donald, Lucy Cheser Jacobs, Chris Sorensen, and AsgharRazavieh, *Introduction to Research in Education Eight edition*.
- Bobbi DePorter, and Mike Hernacki, Quantum Learning“Membiasakan Belajar Nyaman dan Menyenangkan”, Bandung: PT. MizanPustaka, 2003.
- Dunn, Rita and Shirley A Griggs, *Practical Approach to Using Learning Style in Higher Education*, English: Library Congres Cataloging in Publication Data. 2000
- Elfrida H. Hiebert and Michael L. Kamil, *Teaching And Learning Vocabulary*, New Jersey: Lawrence Elbaum Associates, 2005
- FuadMas’ud, *Essential of English Grammar: a partical guide*, Yogyakarta: BPFE, 2005
- H. Douglas Brown, *Teaching by Principles an Interactive Approach to Language Pedagogy (Second Edition)*.
- H. Douglas Brown, *Principle of Learning and Teaching fourth edition*, New York: Longman. 2000
- Nana Sujana, *MetodeStatistika :The world book student hand book*, Chicago: Child craft international, Inc, 1978

Topic : Humanities

**Hidden Aspects of the Private Language Argument:  
What Will Wittgenstein's Philosophy Bring Us Henceforth?**

Toshio Irie\*

*Faculty of Letters, Chiba University, 1-12 Yayoi-Cho Inage-ku, Chiba-shi, 263-8522, Japan*

---

**Abstract**

In *Philosophical Investigations* (henceforth *PI*), Ludwig Wittgenstein presents a famous argument called "the private language argument" (PLA). The PLA has been treated as one of the decisive criticisms of Cartesian dualism, which locates "mind" in the inner realm of each person, in contradistinction to "material things" in the outer world. However, it is difficult to grasp the PLA's true intention and potential.

The PLA has been interpreted as a kind of *reductio ad absurdum*. Gordon Baker has recently questioned this interpretation, insisting that the PLA is intended not as a demonstration but as the initiation of a change in our way of seeing things imprisoned by linguistic illusions.

This presentation develops Baker's new framework by associating it with Wittgenstein's philosophy of mathematics, which was his main concern before he changed the organization of *PI* to include considerations about mental concepts, beginning with the PLA (the "intermediate version" of *PI*), instead of considerations about mathematics (the "pre-war version" of *PI*). First, I show an illuminating connection between Baker's framework and Wittgenstein's view that mathematical proofs change our perspective. I then propose to associate with the PLA a fragment of Wittgenstein's view of rule-following, written just before he changed the organization of *PI*. This connection is found in the inevitable factors in the rule-following of the *circumstance* surrounding linguistic activity and the *reaction* of a linguistic agent, which shed light on the contingency and locality of language understanding.

**Keywords**

Wittgenstein, private language, rule-following, philosophy of mathematics, concept formation

---

**1. Introduction**

In *Philosophical Investigations* (henceforth *PI*), the masterpiece of the later Wittgenstein, is a very famous argument called "the private language argument" (henceforth, PLA). The PLA lies at the beginning of critiques of the notion that mental concepts such as pain, thoughts, images, and consciousness describe private processes occurring in the inner realm of each person. The PLA has been treated as representative of the critique of Cartesian dualism, which locates the mind in the inner world in contrast

---

\* Corresponding author. *E-mail address*: toshioirie@gmail.com

with the body and material things in the outer world. In examining the PLA closely, however, grasping its genuine points and its potentiality is a difficult task.

Up to the present, the PLA has been interpreted as a kind of *reductio ad absurdum*. However, Gordon Baker has recently called this interpretation into question, insisting that the PLA is intended not as a demonstration, but rather as an effort to bring about of a change in our way of seeing things, a way of seeing things that has been held prisoner by linguistic illusions.

This presentation develops the PLA interpretation further in Baker's direction by focusing on the continuity between the PLA and Wittgenstein's consideration of the philosophy of mathematics. Initially, Wittgenstein planned for *PI* to address the philosophy of language in the first half (§§1-188) and the philosophy of mathematics in the latter half (the "prewar" version of *PI*). However, in the spring and summer of 1944, he altered the organization of the book such that instead of the philosophy of mathematics, the PLA and considerations on mental concepts are subsequent to a consideration on rule-following (the "intermediate" version of *PI*). For several years until 1944, Wittgenstein expended considerable effort on the philosophy of mathematics. This presentation focuses on the continuity between the philosophy of mathematics and the PLA.

This presentation deals in particular with a famous section of the PLA, §258. In the next section, I outline of §258 and its interpretative problems. Subsequently, I present Baker's new interpretation (§3). His interpretation can be understood to a greater depth if we pay attention to Wittgenstein's consideration of mathematics; based on this, I use Baker's framework to develop a further interpretation (§4). I suggest a way with regard to the interpretation of *PI* in the closing section (§5).

## 2. § 258 of *PI*

The story of §258 is as follows. "I" want to keep a diary about the recurrence of a certain sensation. To this end, I associate it with the sign "S" and write this sign on a calendar for every day on which I have the sensation. Wittgenstein takes this assumption as he wants, first, "to observe that a definition of the sign cannot be formulated." Responding to this, a further assumption is added. It is supposed that "S" is defined through a kind of ostensive definition such as speaking or writing the sign down and at the same time concentrating my attention on the sensation. Regarding this, he says, "But what is this ceremony for? For that is all it seems to be! A definition serves to lay down the meaning of a sign, doesn't it?" The response to this is: "Well, that is done precisely by concentrating my attention; for in this way I commit to memory the connection between the sign and the sensation." Here are Wittgenstein's last words in this section:

But "I commit it to memory" can only mean: this process brings it about that I remember the connection correctly in the future. But in the present case, I have no criterion of correctness. One would like to say: whatever is going to seem correct to me is correct. And that only means that here we can't talk about "correct" (*PI* §258).

There are many criticisms of the above "argument." For example, it is possible for a private language speaker to talk about "correct" because it is possible for each private language speaker to identify their own sensation, keep that in their memory, and recognize a similar sensation when it occurs in the future without external criteria; a public community is not necessary for deciding what is correct because the stability of the speaker's disposition is sufficient. Therefore, if we regard the above "argument" as a kind of *reductio ad absurdum*, we must provide some grounds for why what is accessible to private language speakers is insufficient grounds for correct or incorrect. Here, both the for and against for the argument are inconclusive.



### 3. Baker's Interpretation

Recently, Gordon Baker presented a new interpretation. According to him, the PLA is not intended to give a demonstration of *reductio ad absurdum*. The main concern of the PLA is rather to remove the prejudice that stands in the way of our seeing the actual use of expressions.

One of Baker's main interpretative strategies is comparing the PLA with the opening sections of *PI*, where Wittgenstein's point is much easier to see. There, Baker says, Wittgenstein calls attention to a set of very general notions that affect almost everybody who reflects on the meaning of words—namely, the notions that every word is a name, that the meaning of a word is the object correlated with it, and that every sentence is a combination of words with the function of describing some state of affairs. Wittgenstein notes that this widespread conception, “a particular picture of the essence of human language” (*PI* §1), “surrounds the working of language with a haze which makes clear vision impossible” (*PI* §5). Baker characterizes that picture, using Wittgenstein's phrase, as a “grammatical illusion,” and indicates that the PLA deals with the same grammatical illusion, which elaborates the model of name and designation (Baker 1998: 348).

By finding similarities between the PLA and the opening sections of *PI*, Baker makes an important remark concerning §258. Wittgenstein imagines a very simple system of signs in the opening sections of *PI* (§§2-3) and then goes on to use this simple language game as an object of comparison to highlight both its differences and similarities with the everyday use of words. Hence, following Baker, the example of a sensory diary in §258 is not a part of a *reductio ad absurdum* but a language game invented as an *object of comparison*. “Comparison between genuine names of sensations and ‘S’ in this imaginary language-game makes perspicuous just how far the everyday use of the words ‘pain’, ‘fair’, etc. deviates from the models of the mere association of signs with immediate experiences” (Baker 1998: 349). Through this comparison, we come to see that “we must establish more complex patterns than what is present, by our hypothesis, in the private speakers' activities” (ibid.) in order for “S” to be a genuine name of a sensation.

Baker closes the comparison with the opening sections of *PI* by stressing that the philosophical activity of dispelling grammatical illusions is very different from that of mapping the logical geography of “psychological concepts.” “It more often consists in taking note of possibilities to which one is blind than of establishing facts of which one is ignorant” (Baker 1998: 349-350). The example Baker invokes for this point is very illuminating: to the question “How do words refer to sensations?” Wittgenstein replies by suggesting the *possibility* of teaching the word “pain” to a child by conditioning him to replace natural expressions of pain (say crying) by a verbal expression of pain (*PI* §244). Appropriately, Baker adds that taking note of this possibility is enough to escape from the compulsion to address the question “What does an avowal of pain describe?”. Baker concludes that attention to possibility doesn't manifest Wittgenstein's modesty, but his method (Baker 1998: 350).

### 4. From Wittgenstein's Philosophy of Mathematics

The character of Baker's interpretation, outlined above, is revealed more vividly in comparison with an important function of a mathematical proof that Wittgenstein sheds light on in his philosophy of mathematics. The following two remarks, the former of which lies in the PLA and the latter of which lies in remarks about mathematics, show the similarity between Wittgenstein's philosophy and his conception of mathematics.

What is your aim in philosophy? — To show the fly the way out of the fly-bottle (*PI*: §309).

Can't we say: the figure which shews you the solution removes a blindness, or again changes your geometry? It as it were shews you a new dimension of space. (As if a fly were shewn the way out of the fly-bottle) (Wittgenstein 1984b: I -§44).

In his philosophy of mathematics, Wittgenstein pays attention to an important function of the mathematical proof, namely, the way the proof brings about changes in our perspective. (cf. Irie, 2012) In a 1935 lecture, Wittgenstein compared unsolved mathematical problems with riddles.

They are like the problem set by the king in the fairy tale who told the princess to come neither naked nor dressed, and she came wearing fish net. That might have been called not naked and yet not dressed either. He did not really know what he wanted her to do, but when she came thus he was forced to accept it. The problem is of the form, Do something which I shall be inclined to call neither naked nor dressed. It is the same with a mathematical problem. Do something which I shall be inclined to accept as a solution, though I do not know what it will be like (Wittgenstein 1979: 185-6).

When the king gave the problem to the princess, there seemed to be nothing to satisfy the conditions of the problem because it was quite natural to think that she had no alternative but to come either naked or dressed. However, by wearing the fish net, "dressed" was changed into "wearing clothes," and a space, a *possibility* of an answer between "naked" and "dressed" emerged. At that moment, we find ourselves in an unnecessary prison (like the fly in the fly-bottle) and set free. The most interesting point regarding riddles is that the *possibility* of giving an answer to the question *emerges afterward* by the giving of the answer itself. In the relation to the answer, the original problem gets *a new aspect*.

In mathematics, we can easily find a similar example of something that was initially thought to be *impossible* proved to be *possible afterward*—namely, the discovery of imaginary numbers. But in the present context concerning the PLA, the proof that trisecting an angle with a ruler and compass is impossible, discussed by Wittgenstein again and again, is more important.

I can't ask whether an angle can be trisected with ruler and compass, until I can see the system "Ruler and Compasses" as embedded in a larger one, where the problem is soluble; or better, where the problem is a problem, where this question has a sense.

This is also shown by the fact that you must step outside the Euclidean system for a proof of the impossibility.

A system is, so to speak, a world (Wittgenstein 1984a: §152).

(We should keep in mind the distinction between *possibility of solving the problem* and impossibility of the trisection of the angle with ruler and compass in mind. These are, so to speak, different levels.) Like the riddle, here the original problem receives *a new aspect* when we see "the system 'Ruler and Compasses' as embedded in a larger one, where the problem is soluble." Here, Wittgenstein refers to a mathematical technique, translation, in which the original problem of Euclidian geometry is reformulated in algebra such that construction with ruler and compasses is translated into the solution of linear and quadratic equations, and the constructability of the trisection of an angle is translated into the solvability of a special type of cubic equation. When we compare geometric constructions with solutions of equations and find the connection between them, the original problem gets *a new aspect*, and at the same time, the *possibility* of a

solution emerges. We manage to “step outside the Euclidean system”—outside the old world into a new world.

The above consideration shows the importance of finding new aspects. Baker also refers to the importance of making apparent aspects that are hidden from us (Baker 1998: 352). But his emphasis is put on dispelling the philosophical illusion, and does not pursue the hidden aspects further. Now, our main topic is §258. Can we pursue the hidden aspect §258 reveals further? What are the hidden aspect §258 reveals?

## 5. A Hidden Aspect that the PLA reveals

The answer to the last question in the previous section is in Baker’s words cited in the penultimate paragraph of §3 in this presentation: through comparison, we come to see that “we must establish more complex patterns than what is present, by our hypothesis, in the private speakers activities” in order for “S” to be a genuine name of a sensation. The hidden aspect that the imaginary language game in §258 reveals is the ‘*complex pattern*’ of our ordinary linguistic activity, which is lacking in private language. But how do we pursue that further?

Here is my suggestion. The last part of §258 strongly indicates the first landing point of the “rule-following consideration” (PI §202), which includes the comment that “to *think* one is following a rule is not to follow a rule. And that’s why it’s not possible to follow a rule ‘privately.’” Saul Kripke has already discussed the connection between the rule-following consideration and the PLA, but in my conjecture, we can pursue a different aspect of the connection shown by Kripke by directing intensive attention to a fragment written on March 18, 1944 (Wittgenstein 2000: MS 124, 149-151). There, Wittgenstein focuses on essential factors of rule-following—that is, the *circumstances* surrounding linguistic activity and the *reaction* of a linguistic agent. Moreover, for this hidden aspect of the connection between the rule-following consideration and the PLA to be revealed, it will be especially useful to take into consideration §262, which belongs to a stream of arguments beginning with §256, including §258. We can expect that revealing the hidden aspect of the connection will bring us “natural limits” (Wittgenstein 2000: MS 124, 151) that determine what has meaning and what does not, showing the penetration of contingency and locality into our understanding of language. This is one of the things that Wittgenstein’s philosophy will bring us henceforth.

## 6. Conclusion

It can be said that this presentation deals with *two* hidden aspects of the PLA. One of them concerns the character of the PLA, the other what the PLA reveals. As to the former, I agree with Baker’s interpretation that the PLA is intended not as a demonstration but as the initiation of a change in our way of seeing things imprisoned by linguistic illusions. This function of the PLA, the hidden aspect Baker reveals is understood deeply by comparing it with an important function of the mathematical proof, namely, the way the proof brings about changes in our perspective. Meanwhile, this comparison makes us realize that the importance of new aspects the PLA reveals should be much more emphasized, and the latter of the two hidden aspects concerns this emphasis. We can see this hidden aspect, which §258 reveals, in detail by directing intensive attention to a fragment concerning rule-following written on March 18, 1944. This aspect is expected to show the limits of language in later Wittgenstein, reflecting the penetration of contingency and locality into our understanding of language.

## References

Baker, G. (1998). The private language argument. *Language & Communication* 18.4: 325-356.

- Irie, T. (2012). On an Important Aspect of Relations between a Problem and Its Solution in Mathematics and the Concept of Proof: The Evolution of Wittgenstein's Philosophy of Mathematics from *Tractatus Logico-Philosophicus* to *Bemerkungen über die Grundlagen der Mathematik*. *Philosophy of Science*, Vol.45, No.2, pp.115-129. The Philosophy of Science Society, Japan. (in Japanese)
- Wittgenstein, L. (1979). *Wittgenstein's Lectures: Cambridge 1932-1935*, Alice Ambrose (eds.), Blackwell.
- (1984a). *Philosophische Bemerkungen: Werkausgabe Band 2*, Suhrkamp.
- (1984b). *Bemerkungen über die Grundlagen der Mathematik (3rd ed.): Werkausgabe Band 6*, Suhrkamp.
- (2000). *Wittgenstein's Nachlass: The Bergen Electric Edition*, Oxford University Press.
- (2009). *Philosophical Investigations (4th ed.)*, P. M. S. Hacker & J. Schulte (ed.), Wiley-Blackwell.

**Topic : Remote Sensing**

## **Investigation of a High Resolution Lidar Using Optical Frequency Comb**

Nobuo TAKEUCHI

*CEReS, 1-33 Yayoi-cho, Inage-ku, Chiba-shi, Chiba 263-8522 Japan*

---

### **Abstract**

An optical frequency comb (OFC) is a spectrum consisting of a series of discrete, equally spaced elements. The invention of the OFC is of key importance in fields like optical spectroscopy, ultrashort pulse generation, optical clocks, and for calibration of optical frequency standards. OFC can be generated usually by a mode locked laser. The use of fiber laser enables a compact and robust OFC laser system. The OFC allows a direct link from radio frequency standards to optical frequencies, so that the OFC improved the accuracy of the frequency standard by several orders of magnitude. Also high-precision distance measurement technology has always been playing an important role in the fields of high-tech industries and scientific research. The ability to determine absolute distance to an object is one of the most basic measurements of remote sensing. High-precision monitoring has important applications in both nm-accuracy measurement of small size structures and also long-distance range finding such as lidar. The OFC provides the sub-cm accuracy in long range lidar detection, as well as nm accuracy in the meter-size measurement. The chirping laser OFC technology is considered, too. The feasibility of some cases of lidar configuration is considered and their performance assessment is given.)

### **Keywords**

Lidar, High resolution, Optical frequency comb, High accuracy ranging,

#### **1. Introduction**

Recently there has been a remarkable synergy between the technology of precision laser stabilization and mode-locked ultrafast lasers. This has resulted in control of the frequency spectrum, which consists of a regular “comb” of sharp lines, produced by mode-locked lasers (Hänsch, 2006, Hall, 2006, Ye et al,2004). Such a controlled mode-locked laser is a “femtosecond optical frequency comb generator.” For a sufficiently broad comb, it is possible to determine the absolute frequencies of all of the comb lines. This ability has revolutionized optical frequency metrology and synthesis. It has also served as the basis for the recent demonstrations of atomic clocks that utilize an optical frequency transition. In addition, it is having an impact on time-domain applications, including phase-sensitive extreme nonlinear optics and pulse manipulation and control.

##### *1.1. Frequency spectrum of a mode-locked laser*

To understand how frequency-domain techniques can be used to control mode-locked lasers, we must first connect the time- and frequency-domain descriptions. The electromagnetic field emitted by a mode-locked femto-second laser is composed, in the frequency domain, of a series of modes, regularly spaced in frequency, and phase coherent with each other. The frequency of each mode thus follows the relation

$$\nu_N = N \times f_{\text{rep}} + f_{\text{ceo}} \quad (1)$$

where  $f_{\text{rep}}$  is the repetition rate (typically radio-frequency) of the laser pulses,  $\nu_N$  is the optical frequency of the considered mode,  $N$  a large integer (typically of the order of  $10^6$ ), and  $f_{\text{ceo}}$  is a global shift frequency called “carrier-envelope offset frequency”. This last term is related to the difference between the phase velocity and group velocity in the laser oscillator. It corresponds, in the time domain, to the fact that the electric field is not strictly identical from one pulse to the next, but exhibits a phase shift with reference to the time envelop of the pulse (see Fig. 1)

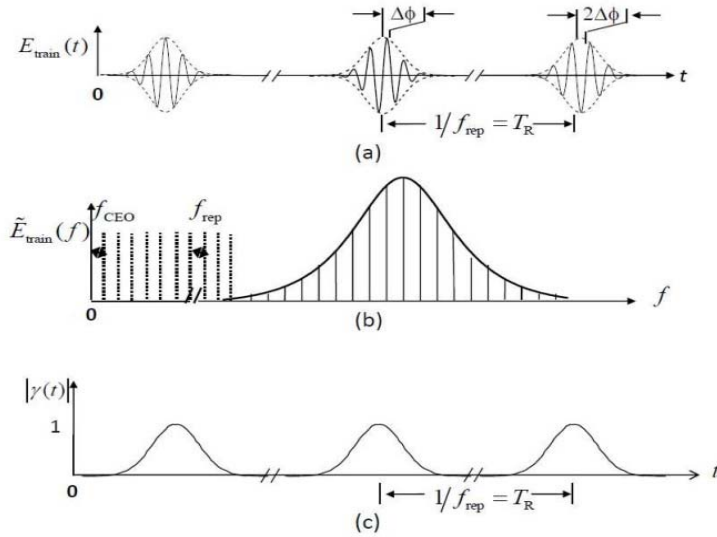

Fig. 1. FOFC and its temporal coherence function. (a) Pulse train in the time domain. (b) Comb lines in the frequency domain. (c)  $T_{\text{CF}}$  of FOFC.

When  $\varphi_{\text{ce}}$  is evolving with time, such that from pulse to pulse (at a time separation of  $T_R = 1/f_{\text{rep}}$ ) there is a phase increment of  $\Delta\varphi_{\text{ce}}$ , then in the spectral domain, a rigid shift will occur for the frequencies at which the pulses add constructively. This shift is easily determined to be  $(1/2\pi) \Delta\varphi_{\text{ce}} / T_R$ . The comb offset is connected to the pulse-to-pulse phase shift by  $f_{\text{ceo}} = (1/2\pi) f_{\text{rep}} \Delta\varphi_{\text{ce}}$ . The relationship between time- and frequency-domain pictures is summarized in Figure 1. The pulse-to-pulse change in the phase for the train of pulses emitted by a mode-locked laser occurs because the phase and group velocities inside the cavity are different. The pulse-to-pulse change in the phase for the train of pulses emitted by a mode-locked laser can be expressed in terms of the average phase ( $v_p$ ) and group ( $v_g$ ) velocities inside the cavity.

Specifically,  $\Delta\varphi_{\text{ce}} = (1/v_g - 1/v_p) l_c \omega_c$ , where  $l_c$  is the round-trip length of the laser cavity and  $\omega_c$  is the “carrier” frequency.

## 1.2. Determining absolute optical frequencies with octave-spanning spectra

The CEP  $\varphi_{\text{ce}}$  is the phase between the carrier wave and the position of the intensity envelope of the pulse (cf. figure in the time domain). In a train of multiple pulses it is usually varying due to the difference between phase and group velocity. The time, after

which the phase increases resp. decreases by  $2\pi$  is called  $T_{CEO}$ . Ideally, it is an integer multiple of the duration  $T_{rep}$  between two pulses and the pulses are picked at the corresponding rate to obtain a constant phase over all picked pulses. Besides this linear evolution, fluctuations which are common in conventional femtosecond laser systems usually cause a nonlinear shot-to-shot fluctuation of the CEP. This is why measuring and controlling it is very important for many applications.

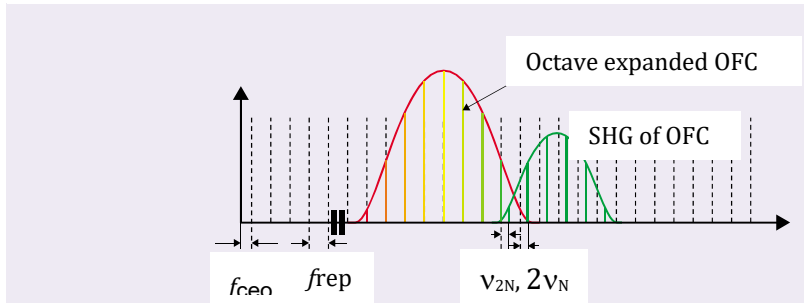

Fig.2 Determination of  $f_{CEO}$ . The large nonlinearity of photonic crystal fiber extends frequency region over one octave. By comparing the higher end on frequency comb and the SHG of fundamental comb,  $f_{CEO}$  can be used without other laser source.

The CEP  $\phi_{CE}$  is the phase between the carrier wave and the position of the intensity envelope of the pulse (cf. figure in the time domain). In a train of multiple pulses it is usually varying due to the difference between phase and group velocity. The time, after which the phase increases resp. decreases by  $2\pi$  is called  $T_{CEO}$ . Ideally, it is an integer multiple of the duration  $T_{rep}$  between two pulses and the pulses are picked at the corresponding rate to obtain a constant phase over all picked pulses. Besides this linear evolution, fluctuations which are common in conventional femtosecond laser systems usually cause a nonlinear shot-to-shot fluctuation of the CEP. This is why measuring and controlling it is very important for many applications.

## 2. Frequency Comb Laser

For the purpose to obtain optical frequency comb system, laser active material has to pose a wide spectral range. Usually rare earth ions are typical material. In Fig.3, their spectral is shown (Nishizawa, 2013).

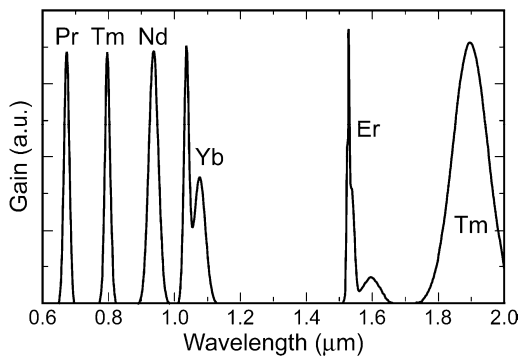

Fig. 3 Gain spectrum of typical rare-earth doped fibers.

Some of typical lasers are describe below.

### 2.1 Ti:Sapphire Laser

Ti:sapphire lasers (also known as Ti:Al<sub>2</sub>O<sub>3</sub> lasers, titanium-sapphire lasers, or Ti:sapphire) are tunable lasers which emit red and near-infrared light in the range from 650 to 1100 nanometers. These lasers are mainly used in scientific research because of their tunability and their ability to generate ultrashort pulses.

Titanium-sapphire refers to the lasing medium, a crystal of sapphire (Al<sub>2</sub>O<sub>3</sub>) that is doped with titanium ions. A Ti:sapphire laser is usually pumped with another laser with a wavelength of 514 to 532 nm, for which argon-ion lasers (514.5 nm) and frequency-doubled Nd:YAG, Nd:YLF, and Nd:YVO lasers (527-532 nm) are used. Ti:sapphire lasers operate most efficiently at wavelengths near 800 nm.

## 2.2 Mode-locked oscillators

Mode-locked oscillators generate ultrashort pulses with a typical duration between a few picoseconds and 10 femtoseconds, in special cases even around 5 femtoseconds. The pulse repetition frequency is in most cases around 70 to 90 MHz. Ti:sapphire oscillators are normally pumped with a continuous-wave laser beam from an argon or frequency-doubled Nd:YVO<sub>4</sub> laser. Typically, such an oscillator has an average output power of 0.4 to 2.5 watts.

## 2.3 Chirped-pulse amplifiers

These devices generate ultrashort, ultra-high-intensity pulses with a duration of 20 to 100 femtoseconds. A typical one stage amplifier can produce pulses of up to 5 millijoules in energy at a repetition frequency of 1000 hertz, while a larger, multistage facility can produce pulses up to several joules, with a repetition rate of up to 10 Hz. Usually, amplifier crystals are pumped with a pulsed frequency-doubled Nd:YLF laser at 527 nm and operate at 800 nm. Two different designs exist for the amplifier: regenerative amplifier and multi-pass amplifier.

# 3. Fiber Lasers

Ti:sapphire laser was first used for frequency comb laser. However, it is large, weak in stability, and difficult to long operation. Especially, the connection to a large nonlinear photonic crystal fiber has a large connection loss and instability. On the other hand, a fiber laser is robust and compact and maintenance free long time operation is possible. (Inaba, H., et al., 2006).

## 3.1 Fiber Laser

A fiber laser is a laser in which the active gain medium is an optical fiber doped with rare-earth elements such as erbium, ytterbium, neodymium, dysprosium, praseodymium, thulium and holmium (see Fig.3). They are related to doped fiber amplifiers, which provide light amplification without lasing. Fiber nonlinearities, such as stimulated Raman scattering or four-wave mixing can also provide gain and thus serve as gain media for a fiber laser.

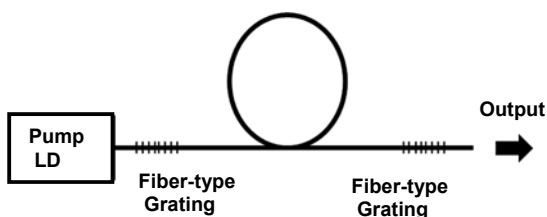

Fig. 4 Fundamental scheme of a fiber laser.



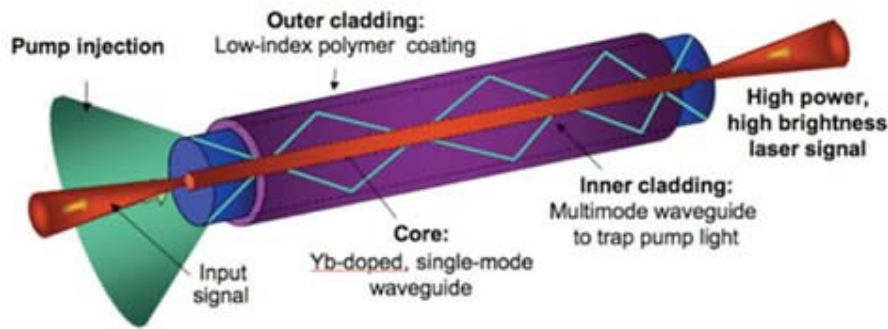

Fig. 5 Example of a fiber amplification scheme.

### 3.2 Advantages and applications

A fiber laser has superior characteristics as follows:

A laser cutting machine with a 2 kW continuous wave fiber laser

The advantages of fiber lasers over other types include:

Light is already coupled into a flexible fiber:

High output power:

High optical quality:

Compact size:

High peak power and nanosecond pulses enable effective marking and engraving.

The additional power and better beam quality provide cleaner cut edges and faster cutting advantages and application speeds.

Lower cost of ownership.

Applications of fiber lasers include material processing (marking, engraving, cutting), telecommunications, spectroscopy, medicine, and directed energy weapons.

Er-doped fiber lasers (EDFLs) can be viewed as EDFAs operating in the particular regime where coherent oscillation of ASE occurs due to some feedback means.

A standard definition could be the following: EDFLs are used as sources for coherent light signal generation, while EDFAs are used as wave-wave amplifiers for coherent light signal regeneration.

All EDFLs can be pumped with compact, efficient, and sometimes inexpensive laser diodes. They are compatible with different fibers and fiber optic components used in communications so they have negligible coupling losses.

Fiber waveguiding and splicing alleviate any mechanical alignment of parts and provide superior environmental stability.

There are many possible laser cavity designs and configurations.

The tunable EDFL configuration presented here uses an all-fiber ring laser cavity.

Wavelength selectivity can be achieved by using a tunable transmission filter.

This example will show how OptiSystem can simulate laser ring design and ASE sources.

The setup parameters are very important to obtain a steady state output power. This means the user must find the minimum number of convergence iterations to obtain correct results.

### 3.3 Erbium-doped Fiber Laser

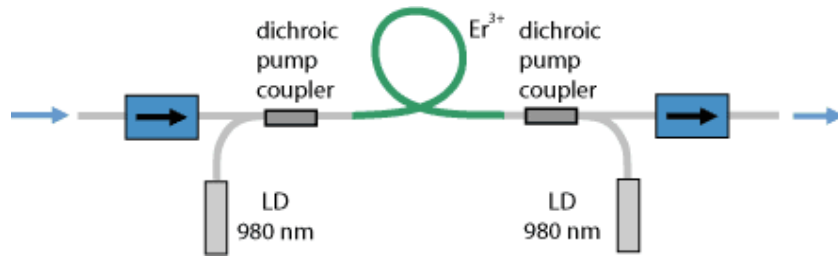

Fig. 6 Schematic setup of a simple erbium-doped fiber amplifier. Two laser diodes (LDs) provide the pump power for the erbium-doped fiber. The pump light is injected via dichroic fiber couplers. Pig-tailed optical isolators reduce the sensitivity of the device to back-reflections.

A typical setup of a simple erbium-doped fiber amplifier (EDFA) is shown in Fig. 6. Its core is the erbium-doped optical fiber, which is typically a single-mode fiber. In the shown case, the *active fiber* is “pumped” with light from two laser diodes (bidirectional pumping), although unidirectional pumping in the forward or backward direction (co-directional and counter-directional pumping) is also very common. The pump light, which most often has a wavelength around 980 nm and sometimes around 1450 nm, excites the erbium ions ( $\text{Er}^{3+}$ ) into the  $^4\text{I}_{13/2}$  state (in the case of 980-nm pumping via  $^4\text{I}_{11/2}$ ), from where they can amplify light in the 1.5- $\mu\text{m}$  wavelength region via stimulated emission back to the ground-state manifold  $^4\text{I}_{15/2}$ . (See also Figure 1 in the article on erbium-doped gain media.)

### 3.4 Ytterbium -doped Fiber Laser

Ytterbium (Yb) is a chemical element belonging to the group of rare earth metals. In laser technology, it has acquired a prominent role in the form of the trivalent ion  $\text{Yb}^{3+}$ , which is used as a laser-active dopant in a variety of host materials, including both crystals and glasses. It is often used for high-power lasers and for wavelength-tunable solid-state lasers.

Ytterbium (Yb) is a chemical element belonging to the group of rare earth metals. In laser technology, it has acquired a prominent role in the form of the trivalent ion  $\text{Yb}^{3+}$ , which is used as a laser-active dopant in a variety of host materials, including both crystals and glasses. It is often used for high-power lasers and for wavelength-tunable solid-state lasers.

### 3.5 photonic band-gap fiber.

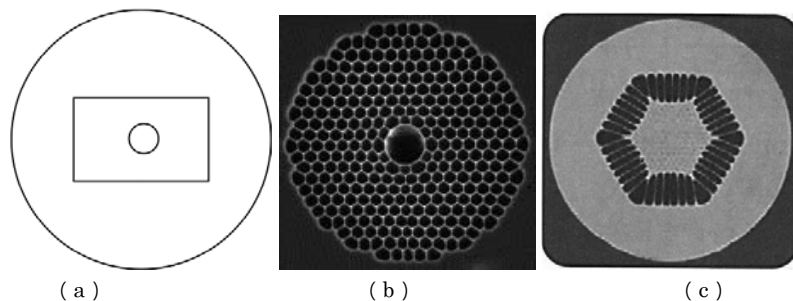

Fig. 7 Cross-sections of typical fibers (a)&(b) double clad fibers, (c) photonic band-gap fiber.

Photonic-crystal fiber (PCF) is a new class of optical fiber based on the properties of photonic crystals. Because of its ability to confine light in hollow cores or with confinement characteristics not possible in conventional optical fiber, PCF is now finding applications in fiber-optic communications, fiber lasers, nonlinear devices, high-power transmission, highly sensitive gas sensors, and other areas. Photonic crystal fibers may be considered a subgroup of a more general class of microstructured optical fibers, where light is guided by structural modifications, and not only by refractive index differences.

Due to special microstructured optical features, it makes possible to expand spectral of transmitting light. (See Fig.8)

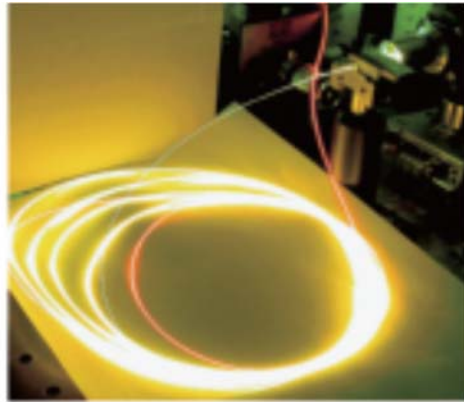

Fig. 8 Spectral expansion of a fiber laser by using a photonic crystal fiber.



### 3.6 Optical Frequency Comb.

Optical frequency comb is generated by phase locking of mode lock laser. For mode-locking, passive and active methods exist. Here passive mode-lock methods are shown in Fig. 9.

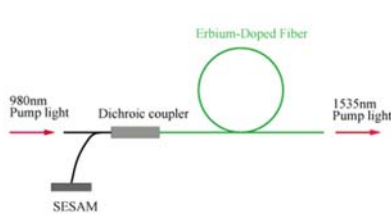

Fig.9(a) Linear type mode-lock fiber laser

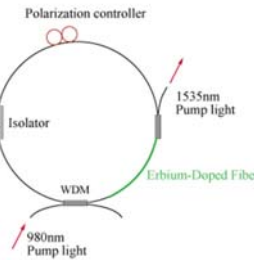

Fig.9(b) Ring type mode-lock fiber laser

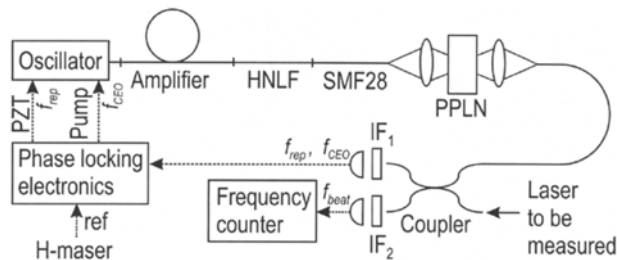

Fig.10 Frequency measurement of Experimental turnkey setup of the frequency measurement system: PZT, piezoelectric transducer (Shibli, 2004)

The frequency comb system under the phase-lock of a mode-lock laser has been used for the national length standard in Japan (2009).

The frequency comb technique is used in the fields of optical clock, optical metrology, frequency chain generation, optical atomic clocks, high precision spectroscopy, and more precise GPS technology.

#### 4. Lidar Application

One of the application of Optical Frequency Comb is the measurement of distance. In distance measurement, usually the beat of probe and reference lights, so the term of "lidar" is not commonly used "lidar", but "range finder" where the distance to a rigid surface is obtained. (Minoshima, 2000, Swann, 2006, Balling, 2009, Coodington, 2009, Baumann, 2013, Wu, G.,2013, Wu, X., 2013).

The lidar system (Minoshima, 2000) which is used for the measurement of 240m distance in an optical tunnel is shown in Fig.11. They measured in the accuracy of  $10^{-6}$ .

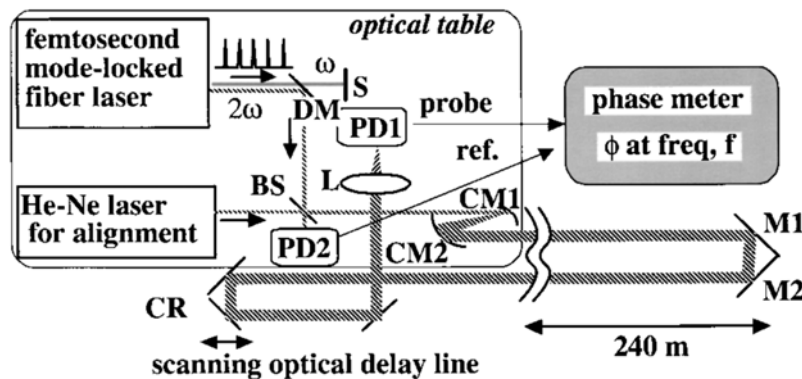

Fig.11 Experimental setup of the high-accuracy distance meter.

In a case of soft target reflection, the return signal is very weak, but the greenhouse gas monitoring over kilometer air path is tried (Rieker, 2014).

#### 5. Dual Comb

Dual comb technique is a method to use two optical frequency comb system with slight frequency difference. The slight difference of resonant frequency is used for step of spectral resolution. (Sasada, 2012).

Many molecules with resonant frequency in NIR are measured.

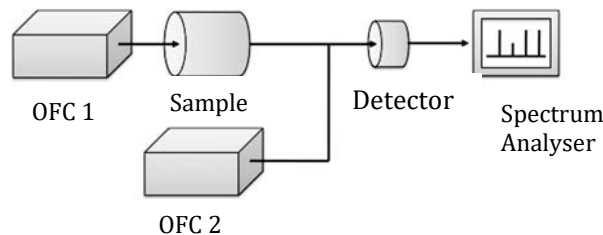

Fig. 12 Principle of Dual Comb.

In Fig.13, Dual comb "green-house gases" monitoring over 2km path is described.

Concentration of  $\text{CH}_4$ ,  $\text{H}_2\text{O}$  and  $\text{CO}_2$  are measured. (Rieker, 2014).

In the case of OFC lidar monitoring, Signal to Noise is said to be limited by shot noise, dark current, etc. However, speckle noise may also limit S/N ratio.

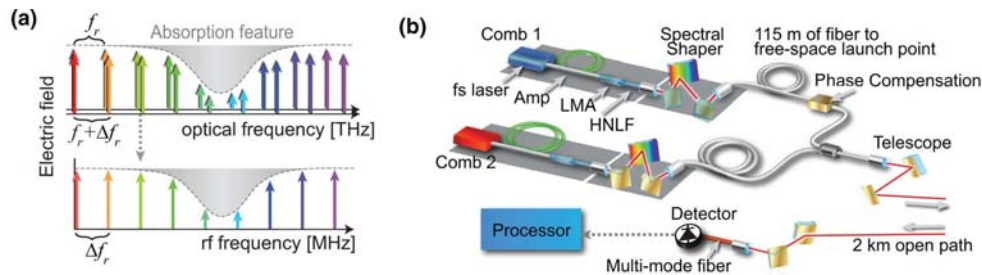

Fig. 13 Open -air path greenhouse gas sensing through dual-com spectroscopy.

Some investigation of detailed system will be shown in the presentation.

## Acknowledgements

The author express deep thanks for information and discussion to Prof. Kaoru Minoshima, UEC, and Prof. Yohei Kobayashi, ISSP, U. Tokyo.

## References

- Balling, P., Kren, P., Masikka, P., van der Berg, S.A., (2009). "Femtosecond frequency comb based distance measurement in air", *Optics Express* **17** 9300.
- Baumann, E., Giorgetta, F.R., Coddington, I., Sinclair, L.C., Kanabe, K., Swann, W.C., Newbury, N.R., (2013). "Comb-calibrated frequency-modulated continuous wave lidar for absolute distance measurements", *Optics Letters*, **38** 2026.
- Boudreau, S., Lévassieur, S., Perilla, C., Roy, S., (2013). "Chemical detection with hyperspectral lidar using dual frequency comb", *Optics Express* **21** 7411.
- Coddington, I., Swann, W.C., Nenadovic, L., Newbury, N.R., (2009). "Rapid and precise absolute distance measurements at long range", *Nature Photonics*. **3** 351.
- Hänsch, T. (2006). "Nobel Lecture: passion for precision", *Review of Modern Physics* **12**, 1297.
- Hall, J. (2006). "Nobel Lecture: defining and measuring optical frequencies", *Review of Modern Physics* **78**, 1279.
- Inaba, H., Daimon, Y., Hong, F.-L., Onae, A., Minoshima, K., Schibli, T. R., Maatsumoto, H., Hirano, M., Okuno, T., Onishi, M., Nakazawa, M., (2006). "Long-term measurement of optical frequencies using a simple, robust and low-noise fiber based frequency comb", *Optics Express* **14** 5253.
- Minoshima, K., Matsumoto, H., (2000). "High accuracy measurement of 240-m distance in an optical tunnel by use of a compact femtosecond laser". *Applied Optics* **39** 5512.
- Newbury, N.R., Swann, W.C., (2007). "Low-noise fiber-laser frequency combs" *J. Opt. Soc. Am. B* **24** 1756.
- Nishizawa, N., (2013). "Development and application of fiber laser", *Optics*, **42**, 438. (in Japanese)
- Rieker, G.B., Giorgetta, F.R., Swann, W.C., Kofler, J., Zolot, A.M., Sinclair, L.C., Baumann, E., Cromer, C., Petron, G., Sweeney, C., Tans, P.P., Coddington, I., Newbury, N.R., (2014). "Frequency-comb-based remote sensing of greenhouse gases over kiloeter air paths", *Optica* **5** 290.
- Sasada, H., (2012), "Current status and prospect of optical frequency comb technology", *Optics* **41** 460 in Japanese.
- Shibli, T.R., Minoshima, K. Hong, F.-L., Inaba, H., Onae, A., Matsumoto, H., Hartl, I. Fermann, M. E., (2004). " Frequency metrology with a turnkey all-fiber system", *OPTICS LETTERS* **29**, 2467

- Swann, W.C., Newbury, N.R.,(2006). "Frequency-resolved coherent lidar using a femtosecond fiber laser". *Optics Letters* **31** 826.
- Wu, G., Takahashi, M., Inaba, H., Minoshima, K.,(2013) "Pulse-to-pulse alignment technique based on synthetic-wavelength interferometry of optical frequency combs for distance measurement" *Optics Letters* **38** 2140.
- Wu, X., Wei, H., Zhang, H., Ren, .L., Li, Y., Zhang, J.,(2013). "Absolute distance measurement using frequency-sweeping heterodyne interferometer calibrated by an optical frequency comb", *Applied Optics* **52** 2042.
- Ye, J., Cundiff.S.T. (2004). "Femtosecond Optical Frequency Comb: Principle, Operation, and Applications", *Springer*

**Topic :** Remote Sensing

## **Modeling of scattering enhancement factor, $f(RH)$ , in Chiba using visibility and ground measurements**

Nofel Lagrosas<sup>a,b\*</sup>, Tomoaki Tsuneyoshi<sup>b</sup>, Naohiro Manago<sup>b</sup>, Hiroaki Kuze<sup>b</sup>

<sup>a</sup>Manila Observatory, Ateneo de Manila University campus, Katipunan Ave. 1108 Quezon City, Philippines

<sup>b</sup>Center for Environmental Remote Sensing, Chiba University, 1-33 Yayoi-cho, Inage-ku, 263-8522 Chiba, Japan

---

### **Abstract**

Monthly scattering enhancement factor,  $f(RH)$ , is evaluated in Chiba in 2014. Hourly extinction coefficients at 875 nm are obtained from visibility meter operated at a Japan Meteorological Agency station located 2.5km south of Chiba University. Absorption coefficients at 875 nm are extrapolated from aethalometer measurements. Scattering coefficients are obtained as the difference between the extinction and absorption coefficients. These scattering coefficients in a month are averaged for every ambient relative humidity (RH). To obtain the dry scattering coefficient, a 7-point running average is applied to the visibility with RH to acquire the power-law fit of the visibility with RH. The scattering coefficient in the 0-30% RH range is the dry scattering coefficient obtained from the fit. The monthly  $f(RH)$  is the ratio of the scattering coefficients and the dry scattering coefficient in a month. A power-law is used to fit the  $f(RH)$  with RH. The winter months show increasing  $f(RH)$  with RH for  $RH > 80\%$ . November, December, January and February show that  $f(RH)$  starts to increase at around  $RH = 75\%$ . The high  $f(RH)$  values in February is considered as the effect of high RH in early morning. The change of  $f(RH)$  with RH is relatively insignificant in the summer months, although  $f(RH)$  rapidly changes with RH for  $RH > 90\%$ . This rapid increase can be explained as the effect of the presence of higher volume concentration of organics in the atmosphere, as revealed in the chemical component analysis previously conducted by our group.

### **Keywords**

*Scattering enhancement factor, relative humidity, visibility meter, absorption coefficient, scattering coefficient.*

---

## **1. Introduction**

Aerosols are liquid and solid particles that are suspended in the atmosphere. They are produced from natural and man-made activities (Seinfeld & Pandis, 2006). Their scattering properties depend on their size, chemical and optical characteristics. Aerosol growth takes place under conditions of increasing relative humidity (RH) and changes the scattering properties considerably. The parameter used to quantify aerosol scattering properties with RH is the scattering enhancement factor,  $f(RH)$ . It is defined as

---

\* Corresponding author Tel.: +63915-3605-398; fax: +632-426-0847.  
E-mail address: nofel@observatory.ph

the ratio of the scattering coefficient at a particular RH,  $\alpha(RH)$ , to the dry scattering coefficient:

$$f(RH) = \frac{\alpha(RH)}{\alpha(RH_{dry})} \quad (1)$$

where  $\alpha(RH_{dry})$  denotes the scattering coefficients at a dry RH. Different aerosols have different responses to increasing RH. Previous studies have shown that the changes of  $f(RH)$  with RH for sea salt is high compared to dust (Zieger et al., 2013, Pan et al., 2009). In Chiba, seasonal changes of RH exist and aerosols are composed of different types (Fukagawa et al, 2006). The objective of this work is to measure and produce a monthly model of  $f(RH)$  of aerosols in Chiba. Such a study of hygroscopic growth of particles in the real atmosphere is important from the viewpoints of the influence of aerosol on the radiation budget and understanding the onset of cloud formation in which aerosols work as the cloud condensation nuclei (Seinfeld and Pandis, 2006).

## 2. Aerosols and RH characteristics in Chiba

The composition of aerosols in Chiba varies according to seasons (Fukagawa et al, 2006). Ammonium sulfate and elementary carbon, for example, are seen to have high concentrations during summer and winter, respectively. Sea salt also exhibits high concentrations during summer. Ground measurements of RH in Chiba show that summer and winter months have the highest (~80%) and lowest (~45%) mean RH values, respectively. However, the month of February can have RH values that can reach up to 95% in the early hours of the morning. These variations of RH and aerosols provide a complex nature of the collective scattering properties of aerosols. Nevertheless, measurement of  $f(RH)$  from ground data collected over a year can offer the seasonal changes of the scattering properties of aerosols.

Conventionally measurements of  $f(RH)$  have been achieved using two integrating nephelometers that measure scattering coefficients of ambient and then dry air (Fierz-Schmidhauser et al., 2010, Zieger et al., 2013). In this work, we propose the determination of  $f(RH)$  through the monitoring of the ambient atmosphere by employing visibility, nephelometer and aethalometer data.

## 3. Methodology

The Japan Meteorological Agency (JMA) measures the hourly visibility values at Chiba city's District Office using a "present weather detector" (Vaisala PWD 22). The data are obtained from JMA's website (<http://www.data.jma.go.jp/>). The visibility meter is located around 2.5 km south of Chiba University (Figure 1a). Figure 1 (b) and (c) show the image of the aerosol measurement unit (aethalometer, nephelometer, particle counter) located at CEReS, Chiba University, and that of the visibility meter, respectively.

The visibility meter can measure a maximum visibility value of 20 km. In the present analysis, visibility values less than 20 km are used to generate the extinction coefficient at 875 nm. Values of ambient RH are also obtained from JMA's website. The extinction coefficient is extracted from the visibility data using

$$\alpha_{ext} = \frac{2.996}{V}, \quad (2)$$

where  $\alpha_{ext}$  and  $V$  are the extinction coefficient and the measured visibility. The factor 2.996 is the logarithmic attenuation of 5% of the original intensity, i.e.,  $\ln(1/0.05)$ . The absorption coefficients at seven wavelengths from 370 to 950 nm are measured using an aethalometer (Magee AE31). The absorption coefficient at 875 nm is interpolated from the linear fit of the logarithm of the absorption coefficient and the logarithm of the



wavelength. The difference of the extinction and absorption coefficient gives the scattering coefficient.

In a month, the scattering coefficient values at the same RH are grouped and averaged. The dry scattering coefficient used in calculating for  $f(RH)$  is the average of the scattering coefficient for  $RH < 30\%$ . The  $f(RH)$  values are fitted using a power law relationship of

$$f(RH) = ax^b + 1 \quad (x = RH / 100). \quad (3)$$

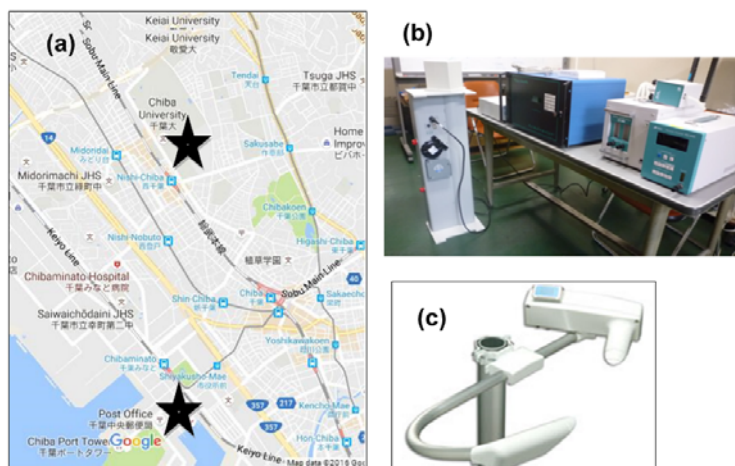

Figure 1. (a) Location of the visibility meter with respect to Chiba University; (b) Aerosol measurement unit, and (c) Vaisala Present Weather Detector (PWD22)  
<http://www.vaisala.com/en/maritime/products/visibility/Pages/PWDPresentweather.aspx>

#### 4. Results and discussion

Figure 2a and b show the measured and modeled dependence of  $f(RH)$  with RH for the months of April and June 2014. These are representative months when  $f(RH)$  shows different responses with RH at high RH. In April,  $f(RH)$  values do not change that much with increasing RH compared to the behavior of  $f(RH)$  in June. This can be attributed to the type of aerosols present in the atmosphere during these months. Previous studies have shown that  $f(RH)$  increases sharply with RH for sea salt but not that much with dust (Zieger et al., 2013). Also, increasing weight percentage of organics in ammonium sulfates tend to decrease  $f(RH)$  values (Garland et al., 2007). In April, aerosols in Chiba have lower sea salt component, high concentration of dust and organics. Asian dust is transported from China and passes over Japan. Local dust may also contribute to the low  $f(RH)$  due to relatively dry conditions. In the month of June, the aerosols in Chiba have a higher concentration of sea salt, with less concentration of dust and organics. This may explain the steeper  $f(RH)$  values at high RH.

Figure 3 shows the trend of modeled  $f(RH)$  with RH for the year 2014. The month of February has higher  $f(RH)$  values with increasing RH and this can be attributed to high RH during early morning although the mean RH of this month is low. This also the reason why  $f(RH)$  values start to increase significantly at around 80% RH. The summer months also show higher  $f(RH)$  values at high RH. This can be attributed to relatively high RH during daytime and nighttime compared to the other months. However,  $f(RH)$  values start to increase significantly at 90% RH. This may be attributed to the fact that, on the average, the aerosols in the atmosphere have significantly increased in size at a particular RH compared to the size of the aerosols at the same RH for different months. Thus, any increase in size contributes to a small increase in the scattering coefficient of these larger aerosols.

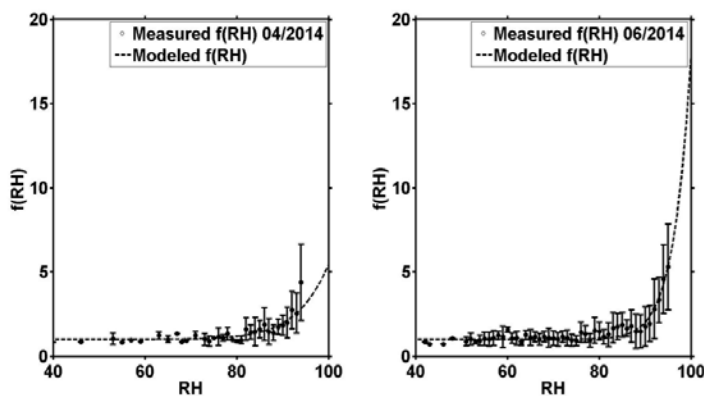

Figure 2. a) Measured and modeled  $f(RH)$  for the month of April 2014. The modeled  $f(RH)$  increases with RH according to Eq. 2 with  $a=4.455$  and  $b=14.38$ . b) Measured and modeled  $f(RH)$  for the month of June 2014. The modeled  $f(RH)$  sharply increases with RH according to Eq. 2 with  $a=16.88$  and  $b=26.60$ .

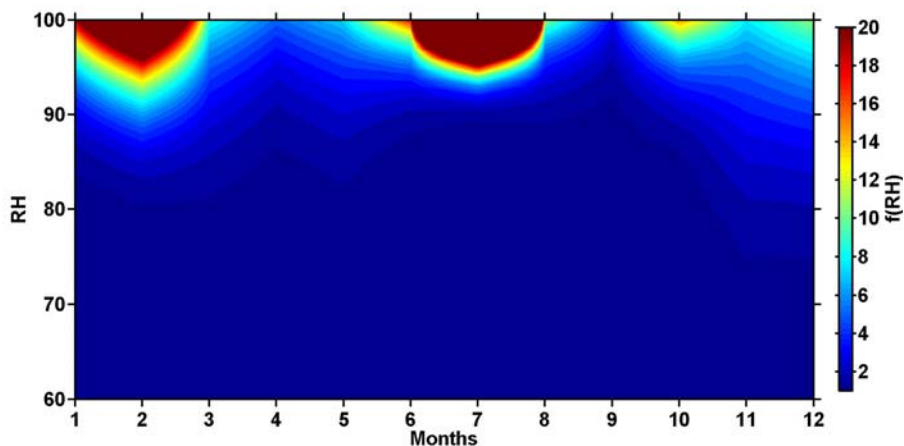

Figure 3. Modeled  $f(RH)$  values for the year 2014.

## Acknowledgement

This work was supported by the CERES Overseas Joint Research for FY2016.

## References

- Fierz-Schmidhauser, P. et al. (2010). Measurement of Relative Humidity Dependent Light Scattering of Aerosols. *Atmos. Meas. Tech.*, 3, 39-50. Copernicus Publications, Germany
- Fukagawa, S. et al. (2006). Characterization of Seasonal Variation of Tropospheric Aerosols in Chiba, Japan. *Atmos. Env.*, 40, 2160-2168. Elsevier Publications, The Netherlands.
- Garland, R.M. et al. (2007). Parameterization for the Relative Humidity Dependence of Light Extinction: Organic-ammonium sulfate aerosol. *J. Geophys. Res.*, 112, D19. American Geophysical Union Publications, USA.
- Pan, X.L. et al. (2009). Observational Study of Influence of Aerosol Hygroscopic Growth on Scattering Coefficient over Rural area near Beijing Mega-City. *Atmos. Chem. Phys.* 9, 7519-7530. Copernicus Publications, Germany.
- Seinfeld, J.H. & Pandis, S.N. (2006). *Atmospheric Chemistry and Physics: From Air Pollution to Climate Change* (2nd ed.), John Wiley & Sons, USA.
- Zeiger, P. et al. (2013). Effects of Relative Humidity on Aerosol Light Scattering: Results from different European sites. *Atmos. Chem. Phys.*, 13, 10609-10631. Copernicus Publications, Germany.

**Topic:** Remote Sensing

## **Observation of Aerosol Optical Properties by Means of Himawari-8 Satellite from Space and Lidar System from Surface**

Jamrud Aminuddin<sup>a,b</sup>, Tomoaki Tsuneyoshi<sup>a</sup>, Nofel Lagrosas<sup>c</sup>,  
Babag Purbantoro<sup>a,d</sup>, Shin'ichiro Okude<sup>a</sup>, Naohiro Manago<sup>a</sup>, and Hiroaki Kuze<sup>a\*</sup>

<sup>a</sup>*Center for Environmental Remote Sensing, Chiba University, 1-33 Yayoi-Cho, Inage-Ku,  
Chiba, 2638522, JAPAN.*

<sup>b</sup>*Department of Physics, Faculty of Mathematics and Natural Science, Universitas Jenderal  
Soedirman, Jl. dr. Suparno 61 Purwokerto, Jawa Tengah, 53123, INDONESIA.*

<sup>c</sup>*Manila Observatory, Katipunan Ave, Loyola Heights, Quezon City, 1108, PHILIPPINES.*

<sup>d</sup>*Remote Sensing Technology and Data Center-Indonesian Aeronautical and Space Agency,  
Jl. Lapan No. 70, Pasar Rebo, Jakarta, 13710, INDONESIA.*

---

### **Abstract**

Observations have been carried out by means of Himawari-8 satellite from space and lidar systems from surface to retrieve aerosol optical properties. The high temporal resolution of Himawari-8 satellite is employed to derive the surface reflectance using band 1 to 6 and brightness temperature using band 7 to 16. The near-surface aerosol extinction profiles, on the other hand, are measured using a plan position indicator (PPI) lidar coupled with a slant path (SP) lidar as well as ground-based sampling instruments. The wavelengths are 349 and 532 nm for PPI and SP lidars, respectively. The general intention of these observations is twofold. First, we verify the consistency of the lidar data in retrieving aerosol extinction with the aerosol data measured using sampling instruments, namely an integrating nephelometer, aethalometer, and an optical particle counter. The difference in humidity conditions between the instrumental and ambient conditions is taken into account through the Mie-scattering calculation. Second, the horizontal distribution measured with the PPI lidar is compared with the aerosol distribution derived from satellite data of Himawari-8, in addition to less frequently observed Landsat-8 and MODIS imagery. In this paper, we describe recent results of our analysis based on lidar observations synchronized with satellite overpass.

### **Keywords:**

Boundary-layer aerosol; PPI lidar; Mie scattering; Satellite data analysis.

---

## **1. Introduction**

Aerosols are liquid and solid particles originated from both natural and anthropogenic sources particles. Aerosols exerts impact on radiation balance of the Earth atmosphere directly and indirectly that can be analyzed by employing their physical properties (IPPC 2007). To obtain better understanding of aerosols, we need the monitoring technique that enables the retrieval of their optical properties. Optical remote

---

\* Corresponding author. Tel.: +81-080-8722-8998; fax: +81-043-290-3857.  
E-mail address: jamrud.aminuddin@unsoed.ac.id

sensing from ground-based instruments as upward looking and satellite platforms as downward looking can provide good understanding of aerosol optical characteristics (Kuze 2012b). The aerosol parameters have routinely observed by the atmospheric group of the Center for Environmental Remote Sensing (CEReS), Chiba University. In this report, the major instruments employed in concurrent measurement with satellite overpass are plan position indicator (PPI) and slant path (SP) lidars. Backscattering signals recorded by lidar systems are analyzed by Fernald method to obtain the aerosol extinction coefficient (Fernald 1984; Klett 1985). In processing data we need lidar ratio that can be obtained by Mie calculation by employing ground-based instruments (Jaenicke 1993; Bagtasa et al. 2007). Since the elevation angles of PPI and SP lidars are small ( $10^\circ$  for PPI and  $30^\circ$  for SP), the major target of these instruments is the aerosol particles in the atmospheric boundary layer.

## 2. Instruments and Methods

The ground instruments consist of plan position indicator (PPI) and slant path (SP) lidars. Besides, there are nephelometer, aethalometer, particle counter, sunphotometer, and weather detector, all of which are operated routinely. The PPI lidar, installed at the roof top of 9th floor of CEReS building about 30 m above the ground as shown in Fig. 1a. The SP lidar utilize a diode-laser-pumped Nd:YAG laser at 532 nm with 200  $\mu\text{J}/\text{pulse}$  and 1000-3000 Hz pulse repetition rate. A photo multiplier tube and a transient recorder for recording the signals as shown in Fig. 1b (Kuze, 2012a, 2012b; Mabuchi et al., 2012).

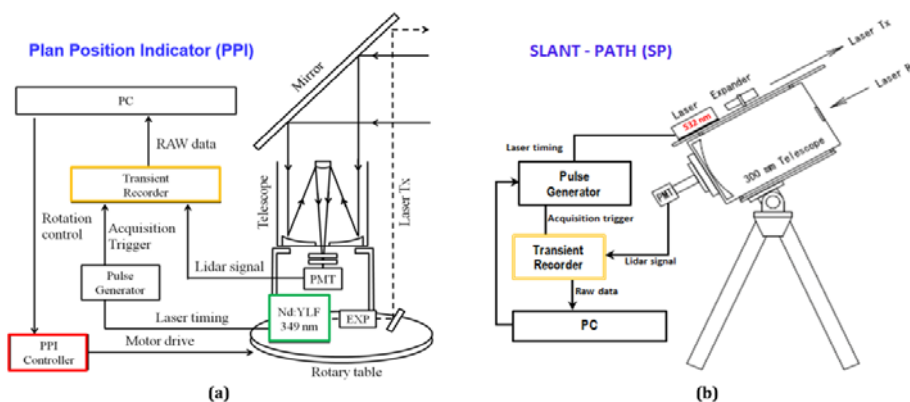

Figure 1. The PPI and SP lidars installed on the 9<sup>th</sup> and 5<sup>th</sup> respectively of CEReS building.

A high-spectral resolution lidar (532 nm) and a Raman lidar (355 nm) are also installed for the direct measurement of the lidar ratio ( $S_1$ ). In order to monitor the aerosol properties inside the boundary layer, the following instruments are operated on the same rooftop as the PPI lidar: a three-wavelength integrating nephelometer (TSI, Model 3563), an aethalometer (Magee Scientific, AE-31), and a particle counter (Rion, KC-22B). These instruments can provide continuous information on scattering, absorption, and size distribution, respectively, on aerosol particles sampled near the roof-top level. In addition, a five-wavelength sunphotometer is routinely operated to monitor AOT during the daytime (Mabuchi et al. 2012). When the cloud influence is insignificant, the sunphotometer data can give good constraint on the aerosol retrieval from lidar measurements. To study the relative humidity effect on particulate growth/ evaporation of hygroscopic aerosols, we have compared the sampling data with the visibility data provided from the Chiba station data of JMA.

### 3. Results and Discussion

Signal of both PPI and SP lidars are processed using the Fernald methods to obtain extinction coefficient (Fernald 1984; Klett 1985). Lidar ratio in Fernald method is obtained from ground based instruments data in Fig. 2 by using Mie calculation (Kuze 2012a; Mabuchi et al. 2012). Employing lidar ratios are 35 sr for PPI and 30 for SP, the extinction coefficient can be computed and their results are shown in Figs. 3 and 4.

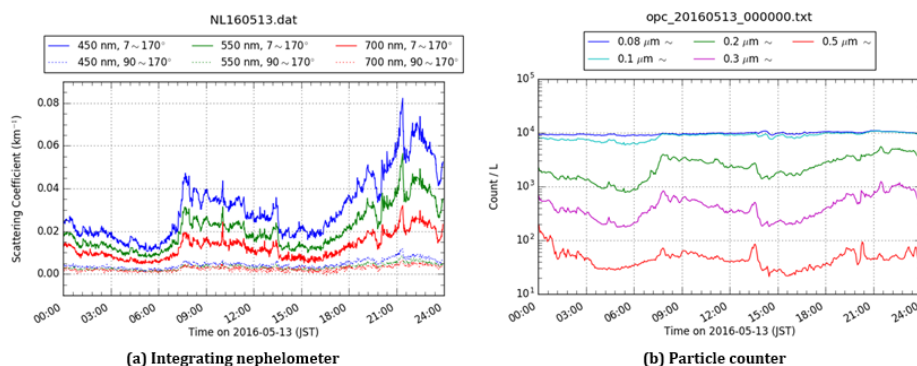

Figure 2. Ground based instrument data retrieved on May 13<sup>th</sup> 2016.

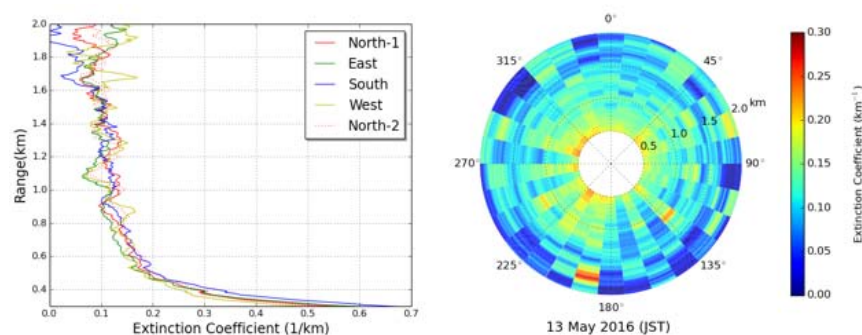

Figure 3. Aerosol extinction coefficient observed using PPI lidar on May 13<sup>th</sup> 2016 at 15.00 JST

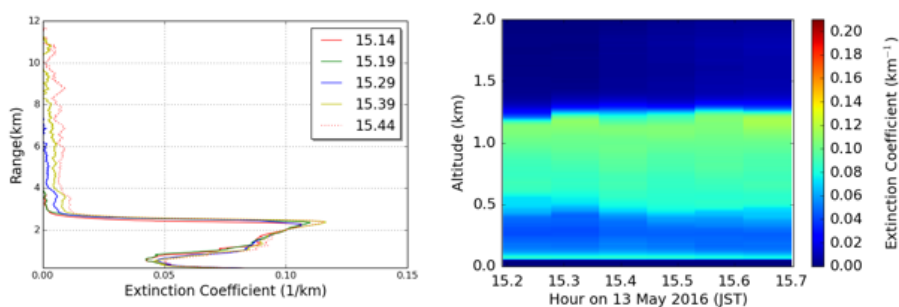

Figure 4. Aerosol extinction coefficient observed using SP lidar on May 13<sup>th</sup> 2016 at 15.00 JST

Surface reflectance of solar energy (shortwave radiation) is an influential parameter for aerosol retrieval from satellite imagery. This parameter is derived from Himawari 8 satellite data by processing Bands 3 in the visible and near infrared (IR) wavelengths (Fig. 5a). On the other hand, brightness temperature as the amount of thermal infrared (TIR) radiation traveling upward from the top of atmosphere is retrieved from Bands 7-14 as infrared wavelength (Fig. 5b). Because of the high temporal resolution, it is possible to characterize both surface reflectance and brightness temperature precisely from Himawari-8 data (Bessho et al. 2015).

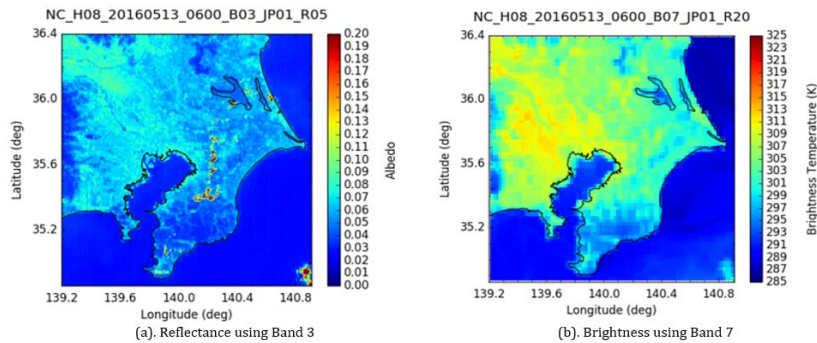

Figure 5. Surface reflectance (albedo) and brightness temperature retrieved from Himawari-8 satellite band 3 and 7 in May 13<sup>th</sup> 2016 at 06.00 UTS or 15.00 JST same time with PPI and SP lidars.

#### 4. Conclusion

In this paper we have described the recent attempt ongoing at CERE<sub>S</sub>, Chiba University, for elucidating the dynamic behavior of aerosol particles in the atmospheric boundary layer. Various instruments including PPI and slant-path lidars are operated to evaluate aerosol parameters concurrently with the satellite observations. Especially, the high temporal resolution of Himawari 8 and high spatial resolution of Landsat satellite are considered to be beneficial for better comparison with and interpretation of ground-based data. Such an approach is a good example of optical remote sensing based on satellite as well as ground-based observations in the field of atmospheric studies.

#### Acknowledgement

One of the authors (JA) as a first author would like to thank the fellowship (BEASISWA DIKTI) from the Ministry of Research, Technology, and Higher Education Republic of Indonesia.

#### References

- Bagtasa, Gerry, Nobuo Takeuchi, Shunsuke Fukagawa, Hiroaki Kuze, and Suekazu Naito. 2007. "Correction in Aerosol Mass Concentration Measurements with Humidity Difference between Ambient and Instrumental Conditions." *Atmospheric Environment* 41 (8): 1616–26. doi:10.1016/j.atmosenv.2006.10.038.
- Fernald, Frederick G. 1984. "Analysis of Atmospheric Lidar Observations: Some Comments." *Applied Optics* 23 (5): 652. doi:10.1364/AO.23.000652.
- IPPC. 2007. "Climate Change 2007 : The Physical Science Basis." *INTERGOVERNMENTAL PANEL ON CLIMATE CHANGE Climate*. Vol. 446. doi:10.1256/004316502320517344.
- JMA. 2015. *Himawari Standard Data User ' S Guide*. Version 1. Tokyo-Japan: Japan Meteorological Agency.
- Klett, James D. 1985. "Lidar Inversion with Variable Backscatter/extinction Ratios." *Appl. Opt.* 24: 1638–43.
- Kuze, Hiroaki. 2012a. "Characterization of Tropospheric Aerosols by Ground-Based Optical Measurements." *SPIE Newsroom*. doi:10.1117/2.1201211.004555.
- . 2012b. "Multi-Wavelength and Multi-Direction Remote Sensing of Atmospheric Aerosols and Clouds, Remote Sensing - Applications." In *InTech, Available From.*, edited by Dr. Boris Escalante, 279–94. In Tech. <http://www.intechopen.com/books/remote-sensing-applications/multi-wavelength-and-multi-direction-remote-sensing-of-atmospheric-aerosols-and-clouds>.
- Mabuchi, Yusaku, Naohiro Manago, Gerry Bagtasa, Hayato Saitoh, Nobuo Takeuchi, Masanori Yabuki, Tatsuo Shiina, and Hiroaki Kuze. 2012. "Multi-Wavelength Lidar System for the Characterization of Tropospheric Aerosols and Clouds." In *International Geoscience and Remote Sensing Symposium (IGARSS)*, 2505–8. Munchen-Germany: IEEE Publisher. doi:10.1109/IGARSS.2012.6351839.

**Topic : Image and Signal Processing**

## **Cloud Retrieval and Cloud Type Detection from Himawari-8 Satellite Data Based on the Split Window Algorithm**

Babag Purbantoro<sup>a,b</sup>, Jamrud Aminuddin<sup>a,c</sup>, Naohiro Manago<sup>a</sup>,  
Koichi Toyoshima<sup>a</sup>, Josaphat Tetuko Sri Sumantyo<sup>a</sup>, and Hiroaki Kuze<sup>a\*</sup>

<sup>a</sup>*Center for Environmental Remote Sensing, Chiba University, 1-33 Yayoi-Cho, Inage-Ku,  
Chiba, 2638522, JAPAN.*

<sup>b</sup>*Remote Sensing Technology and Data Center-Indonesian Institute of Aeronautics and  
Space, Jl. Lapan No. 70, Pasar Rebo, Jakarta, 13710, INDONESIA.*

<sup>c</sup>*Department of Physics, Faculty of Mathematics and Natural Science, Universitas Jenderal  
Soedirman, Jl. dr. Suparno 61 Purwokerto, Jawa Tengah, 53123, INDONESIA*

---

### **Abstract**

Cloud detection and cloud type classification yields basic information indispensable for meteorological as well as climate studies. Here we propose the use of Himawari-8 data. This satellite has been employed for operational use since July 2015, providing spectral data over 16 channels in visible (VIS), near-infrared (NIR) and thermal infrared (TIR) spectral regions. Also, high temporal resolution is available for both full disk (10 min) and Japanese archipelago (2.5 min). First, we test the traditional approach of the split-window algorithm using bands 15 and 16, centered at 12 and 13  $\mu\text{m}$ , respectively, for the determination of cloud density. The brightness temperature difference (BTD) between two bands are derived on the basis of the Planck formula. The resultant threshold temperatures are 250 and 270 K for the discrimination of high, middle and low-level clouds. The BTD thresholds, on the other hand, are determined to be 5 and 11 K for distinguishing very thin, thin or thick clouds. The verification of cloud classification results will also be discussed.

### **Keywords**

Cloud Type Retrieval; Himawari-8; Split Window; Calipso.

---

## **1. Introduction**

The meteorological satellite Himawari 8 was launched by Japan Meteorological Agency (JMA) in October 2014 and started the full operation in July 2015. As compared with its predecessor, MTSAT (Himawari 7), significant improvements have been made in regard to the temporal resolution as well as the number of spectral bands. The acquisition frequency of Himawari-8 is 2.5 min for Japan area and 10 min for the full disk. It has 16 bands in the visible (VIS), near infrared (NIR) and thermal infrared (TIR) spectral regions. Because of these advanced features, the satellite provides remote sensing capability in quite a wide perspective, in addition to its original purpose of meteorological monitoring.

---

\* Corresponding author. Babag Purbantoro, Indonesian National Institute of Aeronautics and Space  
Tel.:+62(0)218710786 fax: +62(0)218771775. E-mail address: babag@lapan.go.id

Based on their altitudes, clouds can roughly be classified into three classes, namely, low-level (<2km), middle-level (2-6km) and high-level (>6km) clouds. Because of the lapse rate of troposphere (~6.5 K/km), the difference in altitudes leads to the difference in the blackbody temperature ( $T_b$ ). Thus, a value of  $T_b$  can be assigned to each pixel of Himawari-8 imagery, depending on the cloud top height and the Planck formula.

In terms of cloud classification, the difference in  $T_b$  between the thermal infrared bands yields useful information. The split window algorithm (Inoue, 1987, 2002 and 2003; Hamada *et al.*, 2004) has widely been used to discriminate various types of clouds. For example, Inoue proposed the use of the two dimensional plot of the 11  $\mu\text{m}$   $T_b$  and the brightness temperature difference (BTD) between 11 and 12  $\mu\text{m}$  bands (hereafter BTD 11-12) to classify cirrus, dense cirrus, cumulonimbus, and cumulus clouds over the tropical ocean (Inoue, 1987). Split window algorithm was particularly suitable for detecting high-level cloud type, but occasionally misclassification occurred for low- and middle-level cloud types (Inoue, 2003). Also a multi-spectral technique to infer the cloud properties using BTD 8-11 and BTD 11-12 was proposed to separate water cloud and ice cloud (Strabala, 1993). In the present work, we apply BTD 15-16 (12 and 13  $\mu\text{m}$ ) to detect the cloud type based on the thickness (density) of the cloud. To help the correct interpretation, lapse rate formula is used to calculate the altitude and verify the cloud type using Calipso data (NASA, 2007). In this research, the 9 cloud types indicated in Figure 1 are examined from the analysis of Himawari 8 images around Japan.

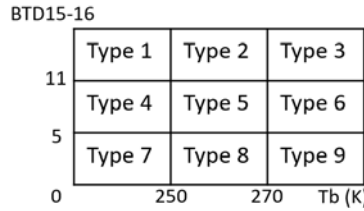

Figure 1. The split window algorithm.

## 2. Method

In this research, we use the geo-corrected full disk data of Himawari-8 downloaded from CERES, Chiba University (<ftp://hmwr829gr.cr.chiba-u.ac.jp/gridded/FD/V20151105/>). Here we use the data cropped only in Japan area (22.02-47.74 N and 120.11-156.99 E). In the first step, radiance ( $I$ ) is calculated for each pixel from the digital count, and subsequently for band 1 through 6, albedo ( $A$ ) is calculated by multiplying the radiance with the transformation coefficient ( $c'$ ) (JMA, 2015):

$$I = \text{Gain} * \text{Count} + \text{Constant}, \quad A = c' I. \quad (1)$$

The values of gain and constant are given in the header information of Himawari-8 data. Comparing the histograms of bands 1 - 6 taken midday, we decided to choose band 1 centered at 0.46  $\mu\text{m}$  for the initial selection of cloudy pixels because of the best capability of distinguishing cloud and non-cloud coverage (Fig. 2). Here the resulting criterion is  $A < 0.28$  for cloud-free area and  $A \geq 0.28$  for cloudy area.

In the second step, we calculate the blackbody temperature,  $T_b$ , using infrared band of Himawari-8 and the following formula (JMA, 2015):

$$T_b = c_0 + c_1 T_e + c_2 T_e^2, \quad (2)$$

where

$$T_e = \frac{hc}{k\lambda} \left[ \ln \left( \frac{2hc^2}{\lambda^5 I} + 1 \right) \right]^{-1}. \quad (3)$$



The values of  $c_0$ ,  $c_1$ , and  $c_2$  are given in the header information of Himawari-8 data. The threshold value was 250 K and 270 K to distinguish between low, middle, and high cloud. This threshold was chosen after many trials in different time of image acquisition.

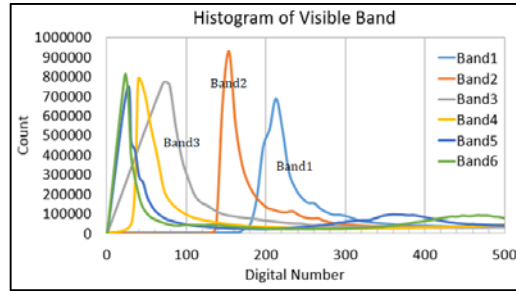

Figure 2. The histogram of Himawari-8 visible bands.

The approximate values of cloud altitudes are estimated using the equation (Wengang, 2010):

$$h = \frac{1}{\delta} (T_S - T_{CT}) \text{ (km)}. \quad (4)$$

Here  $\delta$  is vertical lapse rate constant (6.5 K/km) and  $T_S$  is the surface temperature, which was estimated at the nearest land without cloud cover.

### 3. Results and Discussion

Figure 3 shows an example of the spatial distribution of BTD. Figures 3(a) shows the visible image (band 1). Equations (2) and (3) are used to calculate  $T_b$  of bands 15 and 16. The threshold values of  $BTD = 5$  and  $11$  K have been determined from the analysis. In Figure 3(b), the blue, green and orange colors denote thick, thin and very thin cloud (or clear) area, respectively. Referring to the split window table (Figure 1), the blue color is also related to cloud types of 7, 8 or 9, whereas the green color to types of 4, 5 or 6, and the orange color to types 1, 2 or 3. Figure 3(c) shows the brightness temperature histograms of band 15, 16 and BTD 15-16.

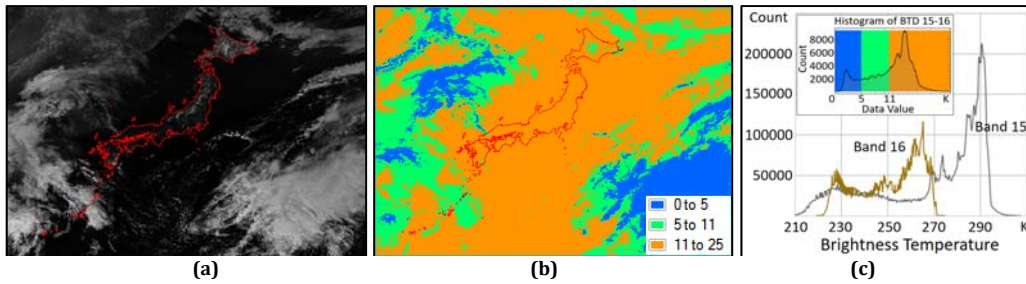

Figure 3. The BTD 15-16 calculation result (a); Visible band (b) The BTD 15-16; (c) Brightness Temperature histogram of Band 15, 16 and BTD 15-16.

To verify the cloud type, the altitude of the cloud each class was checked using the Calipso data. Himawari-8 images taken during the Calipso overpass were chosen for this purpose. The resulting comparison is summarized in Table 1. The list contains the altitude, time and date, position, and water or ice phase information. Here the Himawari-8 result has been conformed to the four classes of Calipso data. The cloud top altitudes estimated using the lapse rate are in reasonable agreement with those from the Calipso data.

**Table 1. Analysis of Himawari-8 clouds with Calipso Data**

Class of cloud	Date Time (UTC)	Position (lat - Long)	Cloud Altitude (Calipso)	Cloud Type	Albedo/ $T_b15$ /BTD15-16/ Cloud type of Himawari-8	Altitude calculation using lapse rate
High-level	2016-08-29; 04:20:0	34.77- 135.42	7 km	Water cloud	0.762/245.99/4.851/7 thick cumulonimbus	$T_s = 289.05$ $h = 6.625$ km
Middle-level	2016-03-17; 04:0:0	29.40- 141.55	3 km	Water cloud	0.581/262.43/6.584/5 altostratus-ice cloud	$T_s = 290.81$ $h = 4.366$ km
Low-level	2016-09-22; 03:30:0	37.47- 147.14	1.3 km	Water cloud	0.323/281.61/11.90/3 cumulus	$T_s = 287.15$ $h = 0.853$ km
Non-cloud	2016-06-26; 04:20:0	37.17- 134.80	-	-	0.095/15.158/284.50/-	-

#### 4. Conclusion

The process of cloud type detection has been described. The altitudes of cloud top heights have been calculated correctly using lapse rate. The cloud types determined using the split window algorithm are found to be in reasonable agreement with the concurrent Calipso data, including the altitude and cloud phase information. The algorithm presented here enables the identification of high cumulonimbus, middle cumulonimbus, low cumulonimbus, altocumulus, thick cirrus, cirrus, thin cirrus, water clouds and ice clouds, with the sole exception of very thin cirrus clouds.

#### References

- Inoue, T. (1987). A Cloud Type Classification with NOAA 7 Split-Window Measurements. *Int. J. Geophysical Research* Vol. 92, No. D4, pp.3991-4000.
- Inoue, T. and T., Ackerman SA. (2002). Radiative Effects of Various Cloud Types as Classified by the Split Window Technique over the Eastern Sub-tropical Pacific Derived from Collocated ERBE and AVHRR Data. *Int. J. Meteorological Society of Japan* Vol. 80, No. 6, pp.1383-1394.
- Lutz, HJ. and Inoue, T. (2003). Comparison of a split-window and a multi-spectral cloud classification for MODIS observations. *Int. J. Meteorological Society of Japan* Vol. 81, No. 3, pp.623-631.
- Strabala, KI. and Ackerman SA. (1993). Cloud Properties Inferred from 8-12 $\mu$ m Data. *Journal of Applied Meteorology*.
- X. Hu. et al. (2015). Automatic Recognition of Cloud Images by Using Visual Saliency Features. *Journal of IEEE Geoscience and Remote Sensing Letters*. Vol. 12. No. 8.
- Wengang, Z. et al. (2010). Study in Retrieval Visibility and Optical Thickness of Fog with MODTRAN. *Multimedia Technology (ICMT), 2010 International Conference on, Ningbo, 2010*, pp. 1-3.
- Japan Meteorological Agency (JMA), (2015). Himawari-8/9 : Himawari Standard Data User's Guide.
- National Aeronautics and Space Administration (NASA) Langley Research Center. (2007). Cloud - Aerosol LIDAR Infrared Pathfinder Satellite Observations (CALIPSO) : Data Management System, Data Products Catalog.

---

## **Hail Detection By A Low Cost Local Weather Radar Operated For Disaster Early Warning System**

Ginaldi Ari Nugroho<sup>1</sup>, Tiin Sinatra<sup>1</sup>, Asif Awaludin<sup>2</sup>, Halimurrahman<sup>1</sup>, Dian Handiana<sup>3</sup>

<sup>1)</sup> *Center for Atmospheric Science and Technology, Lembaga Penerbangan dan Antariksa Nasional (LAPAN)*

<sup>2)</sup> *Chiba University*

<sup>3)</sup> *Indonesia Agency for Meteorology, Climatology, and Geophysics - BMKG*

Email : ginaldi.ari@lapan.go.id

---

### **Abstract**

A local weather radar (LWR) has been developed by modifying X-band marine radar. LWR has been installed and operated to measure precipitation in Bandung area, West Java, Indonesia at 107.586491<sup>0</sup> W and 6.894958<sup>0</sup> S. During its observation, LWR has detected hail falling in West Bandung region on March 26, 2016. LWR can observe hail formation and growth processes thanks to its 2 minutes of sampling interval. Hail occurrence was also confirmed by C-band weather radar installed 120 km away in northwest side of LWR site and black body temperature data of Himawari 8 satellite which analyzed using Auer method. This C-band radar identify hail occurrence at 2.43 pm until 3.14 pm (around 31 minutes). Maximum recorded reflectivity data of this hail precipitation is 58.46 dBZ which close to 55.1 dBZ of C-band radar data. This results confirm that LWR is suitable as a low cost solution for disaster early warning system due to precipitation.

### **Keywords**

Keywords : local weather radar, Himawari 8, hail, reflectivity, disaster.

---

### **1. Introduction**

Deep convective cloud mostly appear in tropical region. This convective cloud can generate severe weathers such as heavy rain, tornado, strong wind and hail. Urban areas are severe weather catastrophe-prone regions due to its dense population and building. Therefore, efforts to predict and monitor severe weather are necessary to avoid huge damage.

Hail, which formed by strong and wide updraft, has diameter until around 5 mm (Barnes, 2010). Many methods have been developed to detect hail. Weather Radar is a useful tool to conduct real time observation of hail. Dual polarization weather radar is very effective for distinguishing rain and hail by measuring  $Z_{DR}$  - differential reflectivity (Marzano et al., 2007). Single-polarization weather radars can not distinguish among different types of hydrometeors, however many method have been developed in order to distinguish between hail and rain using single polarization (Holleman, 2001). Most

single polarization radar is commonly S-Band or C-band system. Recently, there are low-cost short range X-Band systems developed for observing precipitation in urban area (Einfalt T, et al,2004 ; Rollenbeck and Bendix, 2006 ;Van de Beck et al., 2010) and hail storm (Capozzi, V et all, 2016).

In this paper, a preliminary results of using LWR and image processing for hail detection are presented. Hail with rain and strong wind has occurred in urban area of Cimahi city, a west region of Bandung in Indonesia, for around 30 minutes (14.45 pm) in March 26, 2016 (<http://jabar.tribunnews.com> , access May 20<sup>th</sup> 2016). The hail diameter was up to 2 cm with strong wind damaging trees and billboard. A local Weather Radar (LWR) developed in 2012 has been utilized to observe the precipitation around the radar site. The LWR is a precipitation radar developed by modifying an X-band marine radar. Signal and image processing system of the X-band radar are modified to analyze rainfall reflectivity data rather than marine target. Hail observation results were verified by comparing them with measurement results of a C-band weather radar located 120 km northwest of the LWR location.

## 2. Data and Methods

The LWR is a modification results of a marine radar. Data acquisition and digital signal processing are developed for the LWR to extract, overlay, and display precipitation reflectivity (Nugroho and Awaludin, 2013). In order to verify the hail occurrence, observation data from Himawari 8 satellite and Indonesia Agency for Meteorology, Climatology, and Geophysics (BMKG) C-Band weather Radar in March 26, 2016 are utilized. The C-Band weather radar has single polarization and its coverage area compared to the LWR area is illustrated in Fig. 1. White dot is the location of the C-Band radar while the yellow pindrop is the LWR location.

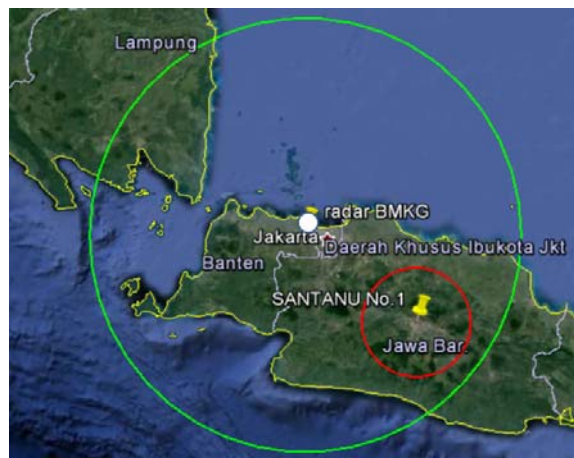

Figure 1. Coverage area of C-Band Radar (green circle) and LWR (red circle).

C-band weather radar with CAPPI method and black body temperature ( $T_{bb}$ ) data from Himawari satellite were used to identify the hail object. Previous research showed that increase on diameter of scattering particles will increase radar reflectivity significantly. Threshold was used to distinguish between severe rain and hail by employing CAPPI method with 57 dBZ (Mason 1971) and 54 dBZ (Auer,1994) of threshold. Obtained hail properties were compared with LWR observation data. Location and reflectivity value were analyzed to know the LWR performance in detecting hail.

### 3. Results and Discussions

A method to recognize hail by using combination of radar reflectivity and cloud-top temperature had been proposed in (Auer, 1994). According to this method, threshold of CAPPI reflectivity ( $Z_{TH}$ ) for hail as a function of cloud-top temperature ( $T_{top}$ ) is given by equation (1). Optimum threshold for this equation varies between 36 and 53 dBZ for cloud-top temperatures between  $-11$  and  $-55^{\circ}\text{C}$ .

$$Z_{TH} = \begin{cases} -0.38.(T_{top} - 85.0) & \text{if } T_{top} \leq -11^{\circ}\text{C} \\ 1.33.(T_{top} + 38.8) & \text{if } T_{top} > -11^{\circ}\text{C} \end{cases} \quad (1)$$

Hail occurrence in Cimahi city, west region of Bandung, was investigated using this method. Black body temperature ( $T_{bb}$ ) data of Himawari 8 satellite was presented as cloud-top temperature data as shown in Fig. 2. This data reveals that cloud with top temperature around  $-60^{\circ}\text{C}$  appears during hail occurrence which indicates strong convective process.  $Z_{TH}$  value of this temperature is 55.1 dBZ.

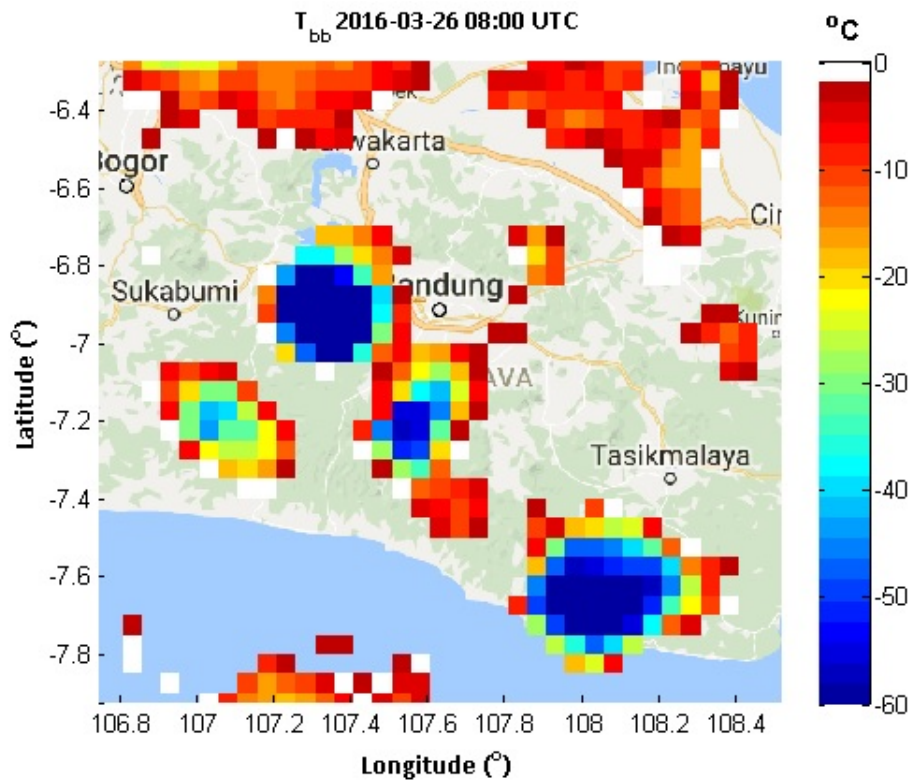

Figure 2. Temperature Black Body ( $T_{bb}$ ) data of Himawari-8 satellite at 08:00 UTC.

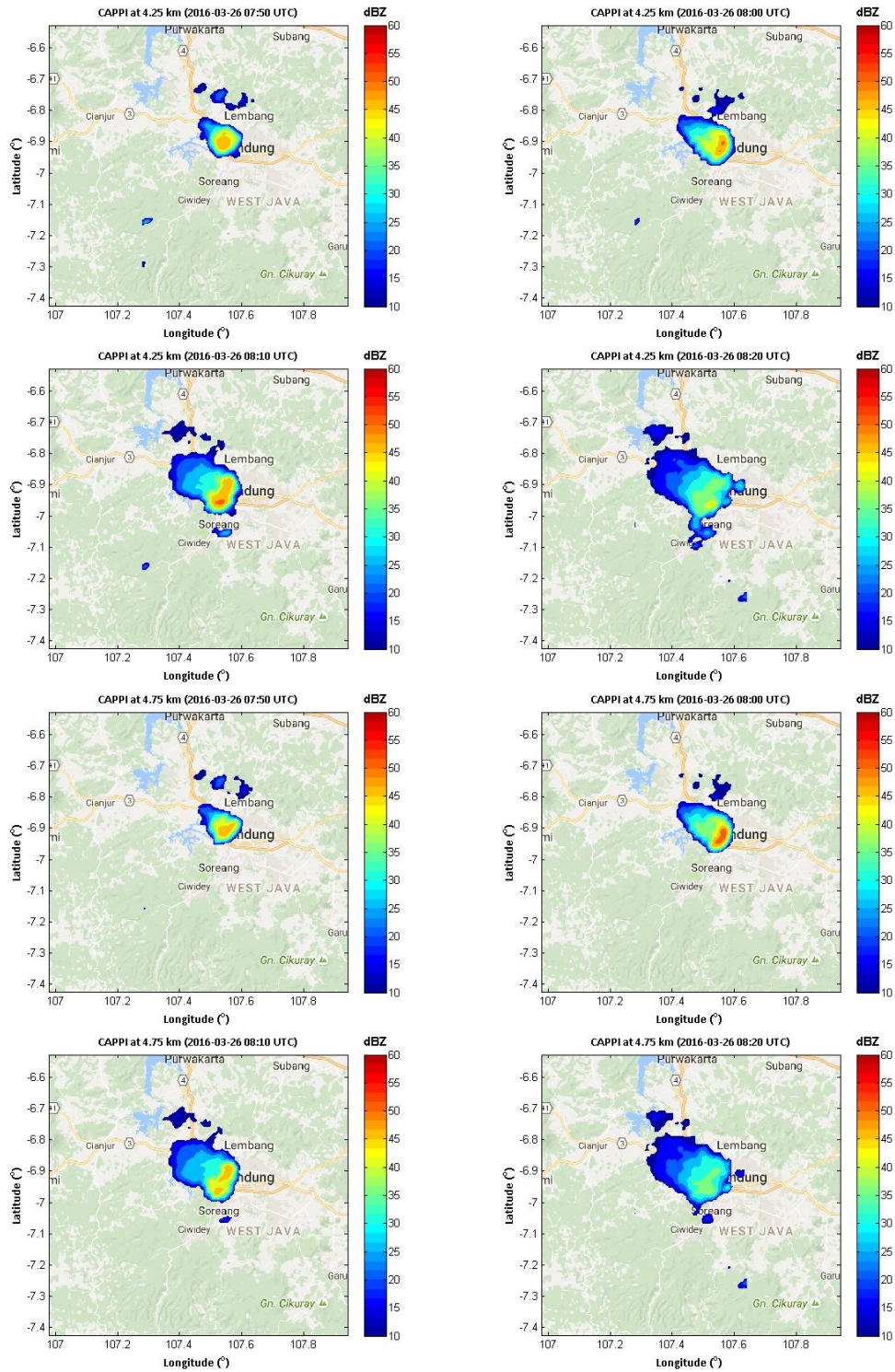
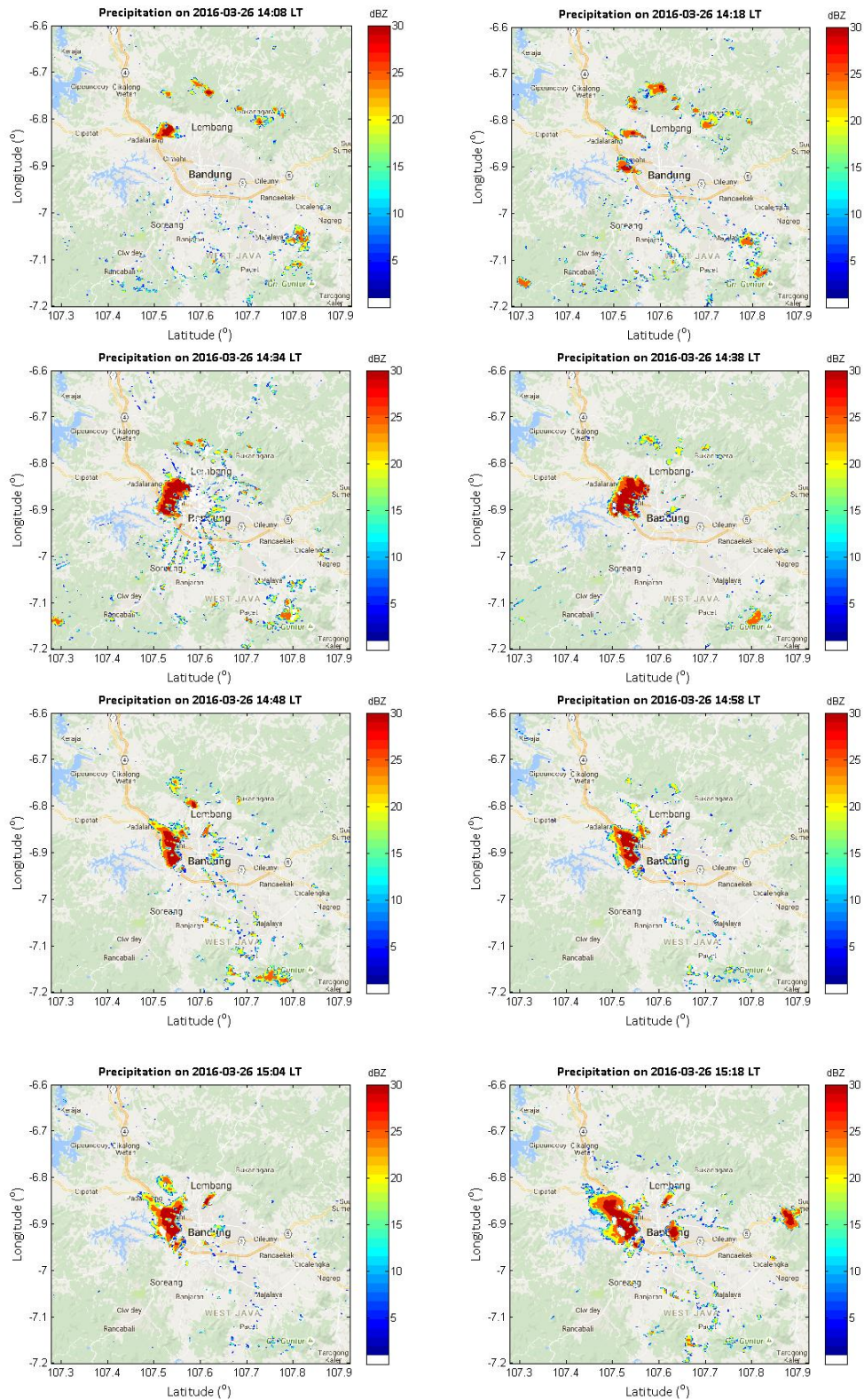

Figure 3. Reflectivity in CAPPI by C-Band weather radar at 4.25 dan 4.75 km.

Observation data by C-band weather radar at constant altitude of 4.25 and 4.75 km were presented to confirm Himawari 8 data. Both radar and satellite data confirm high reflectivity above 50 dBZ at 08:00 UTC but with slightly different location of west Bandung region. Whereas colocation data of both radar and satellite reveals reflectivity

threshold of 40.77-46.38 dBZ in that region. Since cloud top temperature in the colocation area is below  $-30^{\circ}\text{C}$ , it can be concluded as hail occurrence.



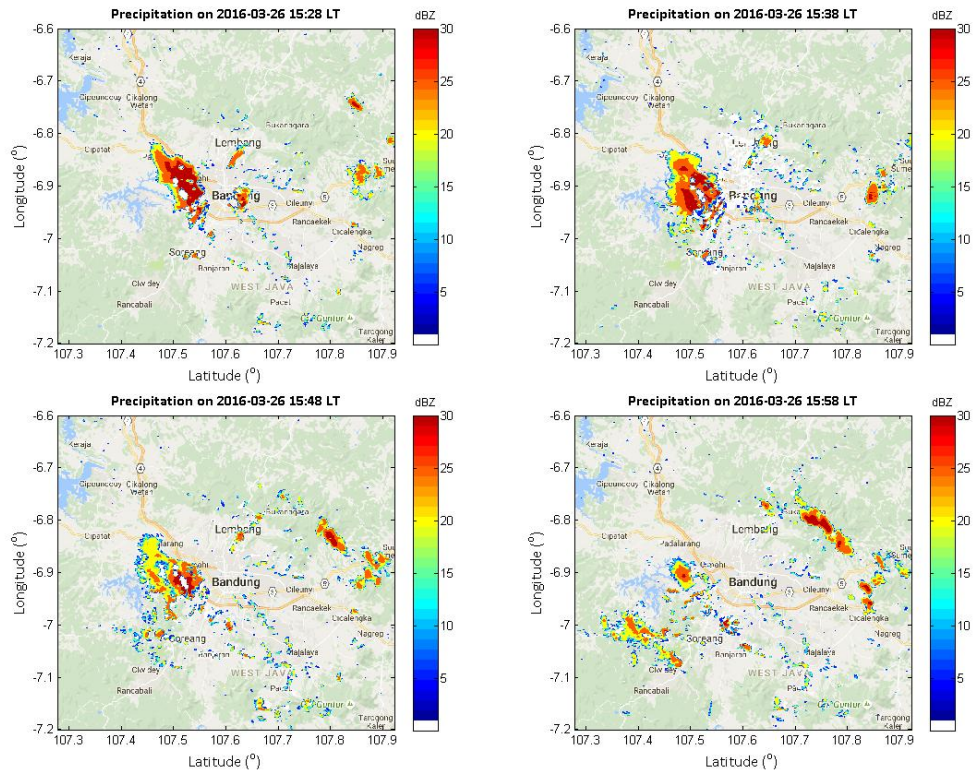

Figure 4. Precipitation evolution from the LWR observation data.

C-Band weather radar data indicated that high reflectivity is detected in west Bandung region. LWR also observed high reflectivity in similar location. Time frame images of both radar showed similar time period of high reflectivity between 07.40 until 08.10 UTC. Thus, according to both radars, hail occurred for about 1 hour 40 minutes. However, the shape of the reflectivity area from both radar are different, this is due to different specification of both radar and also scan method. By using time sequential images as outlined in Fig. 4, it can be observed that the growth of the heavy precipitation (including hail) started at 07.18 UTC, continued to grow at 08.04 UTC, and then dispersed at 08.58 UTC.

Observed LWR reflectivity data is much lower than C-band weather radar results for similar target due to its low power and wide beamwidth. In this regard, 4 kW LWR measurement data has been calibrated using 25 kW X-band weather radar (Nugroho, 2015). According to the calibration results, LWR reflectivity which equal to the X-band radar reflectivity is given by

$$dBZ_{LWR} = 7.338 \times \ln(ADC \text{ count}) + 22.71 \quad (2)$$

By using equation (2), calibration result of 30 dBZ reflectivity in LWR data which has 4,8721 of ADC count is 58.46 dBZ, slightly higher than 55.1 dBZ of C-band radar reflectivity. Both radar data confirm hail occurrence since minimum reflectivity that confirm hail by radar is 50 dBZ (Auer, 1994).

#### 4. Conclusion

Hail occurrence during heavy precipitation in March 26, 2016 has been investigated using developed LWR. Black body temperature ( $T_{bb}$ ) data of Himawari 8 satellite and images data of C-band weather radar data are presented to verify hail detection of the



LWR results using Auer method. Both satellite and C-band radar data confirm the hail occurrence. LWR observation result is in good agreement with C-band radar data in hail detection by recording LWR maximum reflectivity of 58.46 dBZ compared to 55.1 dBZ of C-band radar data.

## Acknowledgements

This research is supported by Center for Atmospheric Science and Technology, Lembaga Penerbangan dan Antariksa Nasional (LAPAN) Indonesia for the LWR project and Indonesia Agency for Meteorology, Climatology, and Geophysics - BMKG for C-Band weather radar data.

## References

- Barnes, G. M., (2010) Meteorological hazards in the Tropics: Severe convective storms and flash floods. Chapter in Tropical Meteorology, Encyclopedia of Life Support Systems (EOLSS) ([www.eolss.net](http://www.eolss.net)), sponsored by the UNESCO, 109 pp.
- Nugroho, G.A., Munir, M.M., dan Khairurrujal. (2015) A Computer-Based Marine Automatic Radar for Rain detection. *Applied Mechanics and Materials*, **771**, 9-12
- Awaludin, A., G.A. Nugroho, dan Rahayu, S.A. (2013) Analisis Kemampuan Radar Navigasi Laut Furuno 1932 Mark-2 untuk Pemantauan Intensitas Hujan. *Jurnal Sains Dirgantara*, **10**, 90-103.
- Auer, A. H., Jr: 1994, Hail recognition through the combined use of radar reflectivity and cloud-top temperatures. *Mon. Wea. Rev.*, **122**, 2218-2221.
- Mason, B. J.: 1971, *The Physics of Clouds*. Clarendon Press, Oxford UK.
- Iwan Holleman Hail detection using single-polarization radar. 2001. Scientific Report, KNMI WR-2001-01.
- Nugroho, G A and Awaludin A. (2013). Mapping method development using digital image processing to calibrate rainfall radar image, International Proceeding 17<sup>th</sup> SIPTEKGAN.
- Marzano, F.S., Budillon, G., Picciotti, E., Montopoli, M., Zinzi, A., and Buonocore, B.: X-band weather radar monitoring realtime products in Rome and Naples urban areas. Tyrrhenian Workshop 2012 on Advances in Radar and Remote Sensing, 2012
- Marzano F.S., Scaranari, D., and Vulpiani, G.: Supervised fuzzy-logic classification of hydrometeors using C-band dualpolarized radars. *IEEE Trans. Geosci. Rem. Sensing*, ISSN: 0196-2892, n. 45, pp. 3784-3799, 2007
- Einfalt T, et al, (2004), Towards a roadmap for use of radar rainfall data in urban drainage, *Journal of Hydrology*, **299**, 186-202.
- Rollenbeck, R. dan Bendix, J., (2006), Experimental calibration of a cost-effective X-band weather radar for climate ecological use in southern Ecuador, *Atmospheric Research*, **79**, 296-316
- Van de Beek, C. Z., Leijnse, H., Stricker, J. N. M., Uijlenhoet, R., and Russchenberg, H. W. J.: Performance of high-resolution X-band radar for rainfall measurement in The Netherlands. *Hydrol. Earth Syst. Sci.*, Vol. 14, pp. 205-221, 2010
- Vincenzo Capozzi, Errico Picciotti, Vincenzo Mazzarella, Giorgio Budillon, Frank Silvio Marzano, *journal Hydrol. Earth Syst. Sci.*, doi:10.5194/hess-2016-177, 2016  
<http://jabar.tribunnews.com>, access May 20<sup>th</sup> 2016

---

**Extreme precipitation over Indonesian maritime continent:  
Uncertainties in satellite estimation and its relationship with  
low storm top height extreme**

Andung Bayu Sekaranom<sup>a,b\*</sup>

<sup>a</sup>*Graduate school of earth and environmental sciences, Nagoya University, Furo-cho,  
Chikusa-ku, Nagoya, JAPAN 464-8601*

<sup>b</sup>*Department of Environmental Geography, Gadjah Mada University, Bulaksumur 28A,  
Yogyakarta, Indonesia 55281*

---

**Abstract**

This paper aims to explain the uncertainties in satellite rainfall estimation due to existence of very high near surface rain, but with relatively low cloud top height over Indonesian maritime continent (MC). More than 15 years of satellite precipitation data recorded by tropical rainfall measuring mission (TRMM) were used in this analysis. The result reveals a large discrepancy between the active precipitation radar (PR 2A25) and passive microwave imager (TMI 2A12) over land surface. PR identifies low storm top height associated with large downward increase of radar reflectivity. In contrast, TMI identifies large ice scattering associated with higher storm top height, but with lower rain rates near surface. Further investigation identifies larger relative humidity and upward vertical velocity at middle part of the troposphere for the low storm height extremes. This condition represents a larger condensation around 300-500 hPa level, but less for the upper part. As a result, it produces lower amount of ice at the upper troposphere, contrasting to the type of extreme precipitation identified by TMI.

**Keywords**

*Keywords: Extreme rainfall, Indonesian Maritime Continent, satellite observation*

---

**I. Introduction**

Indonesian Maritime Continent is one of the tropical area with largest precipitation over the globe. Characteristics of precipitating cloud over this area has been studied intensively especially with advancements of meteorological satellites in measuring precipitation. In early development of the measurement, indirect measurement depends on cloud top brightness temperature (TB) were

---

\* Corresponding author. Tel.: +8190-4189-7611.  
*E-mail address:* andungbayu@geo.ugm.ac.id

used, for example that was implemented by Goddard Precipitation Index (GPI), which measures area with significantly low TB to estimate existence of ice at the top of clouds as a proxy to determine rain-rate (NASA GFSC, 2014).

The most successful mission in retrieving rain-rate based on satellite measurement might be obtained by Tropical Rainfall Measuring Mission (TRMM). This mission provides a record of long term precipitation climatology for 16 years (1998-2014), covering global tropics and subtropics between 50°N-50°S (Kummerow et al. 1998). Current precipitation estimation implemented by the TRMM, are based on active and passive sensors. The active sensor might be the most robust method in measuring precipitation, since it is the first satellite that utilize an on-board radar sensor to estimate precipitation. It is also equipped with a microwave radiometer as a passive sensor measuring brightness temperature from 9 channels.

Rain-rate estimation using an active sensor, for example inside the TRMM Precipitation Radar (PR) are determined based on relationship between radar reflectivity and rain-rate (Iguchi et al., 2000). The satellite emits electromagnetic energy from the top of atmosphere to the earth surface and measure the reflected energy from atmospheric hydrometeors and its travel time. The measurement therefore could produce vertical reflectivity profiles of the atmosphere (Figure 1:left). The reflectivity profiles are then converted to rain-rate based on rain rate (R) - reflectivity ( $Z_e$ ) relationship, considering shape and drop size distribution of the particles (a&b):

$$R = aZ_e^b$$

Rain-rate estimation using passive microwave sensor, on the other hand, measure the trace of longwave emission emitted by hydrometeors particles in the atmosphere (Kummerow and Giglio, 1994). If the atmosphere contains a large number of cloud particles, a higher longwave emission is obtained (Figure 1:middle). An exception is given over land due to influence of land surface emission. The variation of the land surface emission often produce large noises to the emission channels. As a result, the rain-rate estimation could only be determined by trace of ice crystal emission at the top of clouds (Figure 1:right). In this case, precipitation are detected at a significantly low brightness temperature since abundant ice particles will produce low brightness temperature as well as higher precipitation rate.

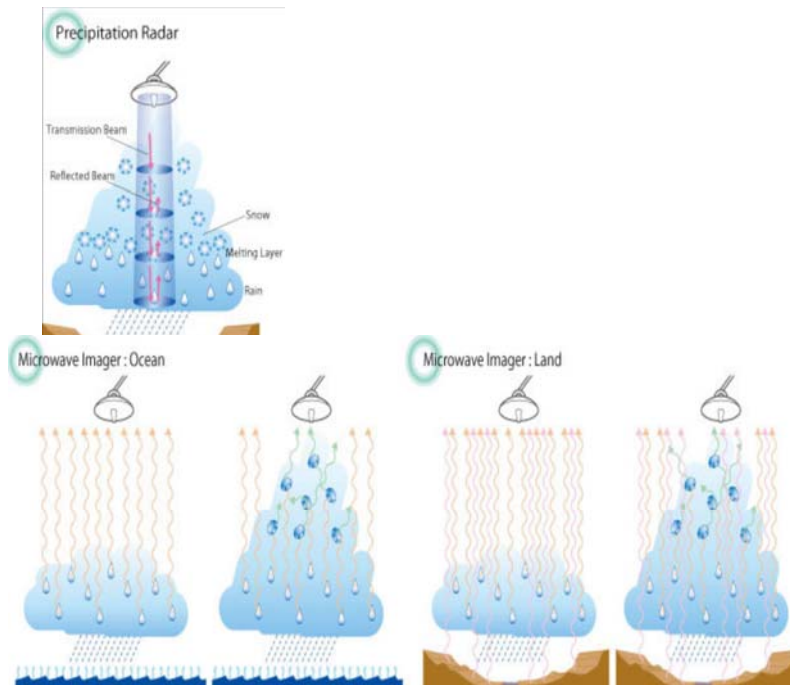

Figure 1. Different principle in satellite rainfall estimation from an active radar sensor (left), passive radar sensor over ocean (middle), and land (right).  
source:<http://www.eorc.jaxa.jp/GPM>

## II. Underlying process between extreme rain and Deep convection

Although the rain-rate estimation from satellite seems to be robust, there are significant discrepancies between the active and passive sensors, as well as its ground validation. Many studies indicated that the discrepancies are large in the regional scale than the global scale. This condition exist especially due to different cloud microphysics and precipitation characteristics at each region, for example between convective and stratiform precipitation.

Over the tropics, extreme rain events are often associated with the deep convective process. The process started to develop by development of low pressure system due to a large amount of heat received by earth surface and force an upward instability. At initial stage, a small cumulus cloud formed due to condensation of water vapor at lower level (Figure 2:growing). The condensation process release latent heat to the atmosphere, which in turn push the condensed water continuously upward. At this stage, snow and ice crystal are formed due to low temperature below freezing level (Figure 2:mature).

The highest precipitation is often associated with maximum cloud growth indicating the beginning of dissipating stage. The maximum growth obtained where significant cloud top height are obtained, forming a flat top where cloud particles could not penetrate the top part of atmosphere, and colliding each other (Figure 2:dissipating). The collision between cloud particles yields larger drops, which are moving down due to gravity. Intense collision between cloud particles are increasing while the droplets moving down, as combined with the coalescence process. Near the earth surface, the droplets melt and becomes rain which then reaching the ground.

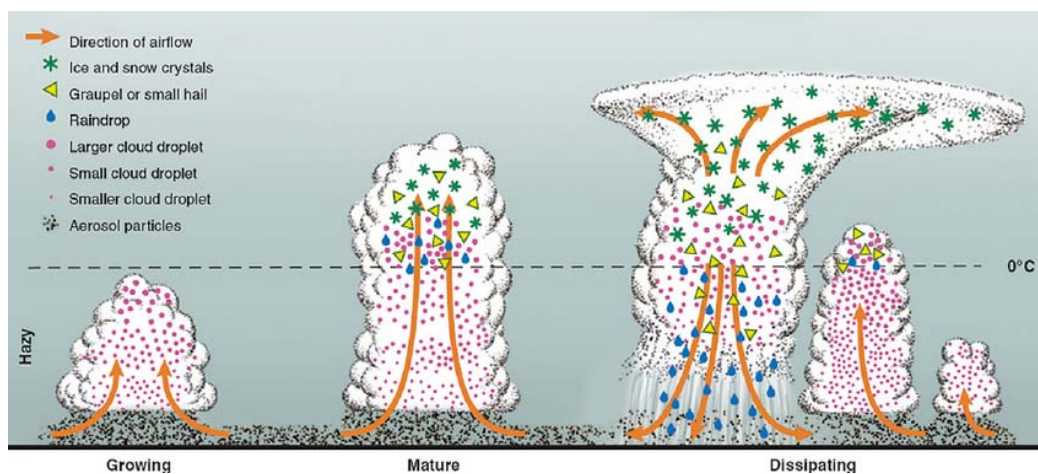

Figure 2. Phases of convective cloud development corresponding to heavy rainfall system (Shepherd, 2013)

### III. The Maritime Continent Low Storm Top Height Extreme

Although the conceptual relationship between storm top height and rain-rate seems to be reasonable, recent research conducted by Hamada et al. (2015) indicates that extreme precipitation at several region over the tropics have lower storm top height than the others, including the Indonesian Maritime Continent. This paper aims to identify the properties of low storm top height extremes over the study area based on more than 15 years of TRMM observation, as well as the discrepancies between the active and passive sensors.

In this study, active sensor derived rain-rate data TRMM PR 2A25 were utilized, as well as the passive sensor from TMI 2A12 product. As a comparison, merged infrared/Microwave, adjusted with ground observation available as TMPA 3B42 were used. Cloudsat reflectivity data were also utilized to clearly explain the discrepancies. The TRMM PR measures reflectivity of precipitating rain drop at 10.3 GHz, while CloudSat measure reflectivity at 94 GHz, in which smaller cloud particles could be identified. In this analysis, we focus on extreme precipitation events, defined as the uppermost 1% of the near surface rain-rate distribution. All

of the three data were collocated to 0.25 square degree resolution with maximum time differences around 3 hours among each other.

The comparison between the three satellite precipitation estimation data indicates that under extreme rain events reveals that the active sensor measures the higher extreme than the passive sensor near the ground level (Figure 3:top). This condition is related to differences between environmental profiles of each extreme events. Over land surface, the passive sensor identify less humid environment at the middle of troposphere. Further investigation reveals that the rain events identified by the active sensor over land have lower storm top heights compared to the passive sensor at a given rain rate (Figure 3:bottom). Those low storm height extreme events are somehow could not be detected by passive sensor. It is likely that this condition represent a condition where water content are abundant at middle level, but with less ice at the upper atmosphere. Therefore the passive microwave sensor miss this kind of extreme event since it only depends on the existence of ice in the top of cloud.

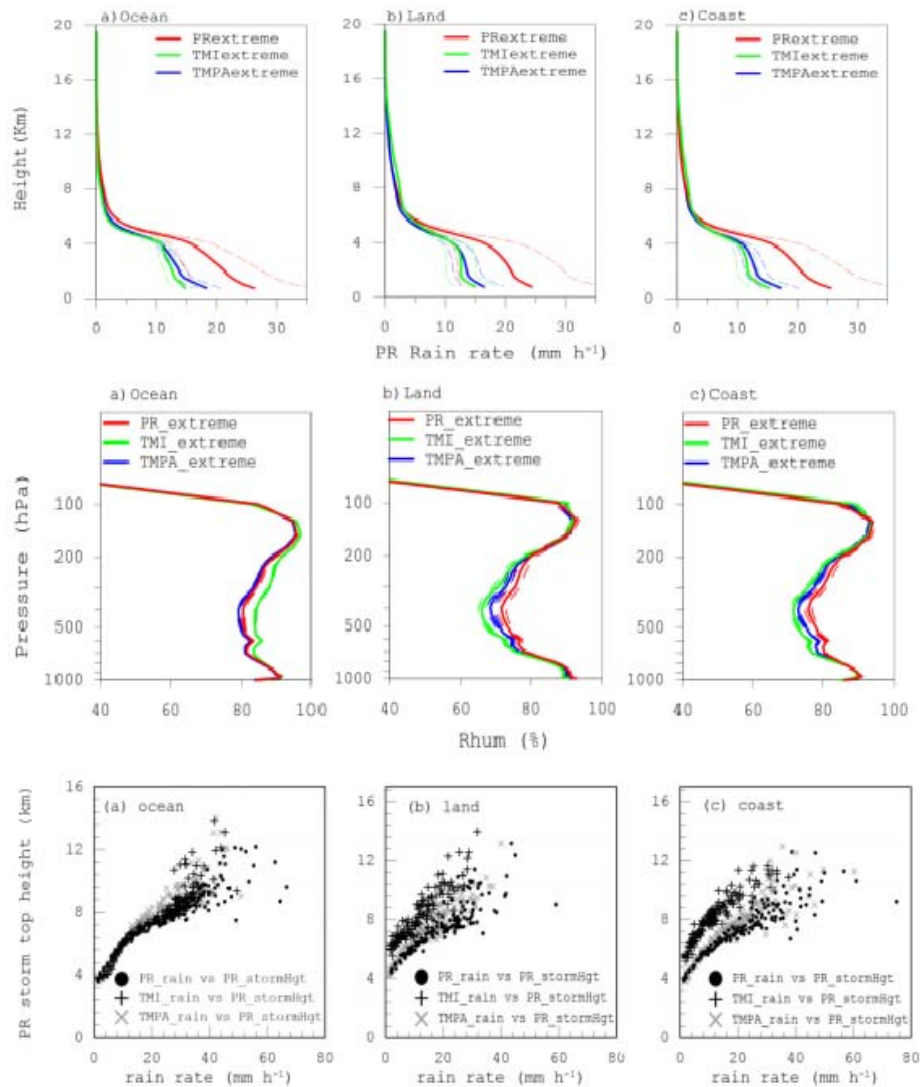

Figure 3. Vertical profile of uppermost 1% extreme rainfall based on collocated TRMM PR active sensor (top) its corresponding relative humidity (middle), and its relationship with storm top height (bottom)

A contrast condition could be observed from the ocean compared to the land surface. Over ocean, the passive sensor detects events that has higher humidity at middle troposphere, but somehow less precipitating than the extreme events identified by the active sensor. Further investigation identifies that although the extreme events identified by the passive sensor have almost similar storm top heights to those identified by the active sensor, they are generated by different precipitation system. Most of the extreme events identified by the passive sensor are generated by stratiform precipitation, while the active sensor identify convective precipitation (Figure 4).

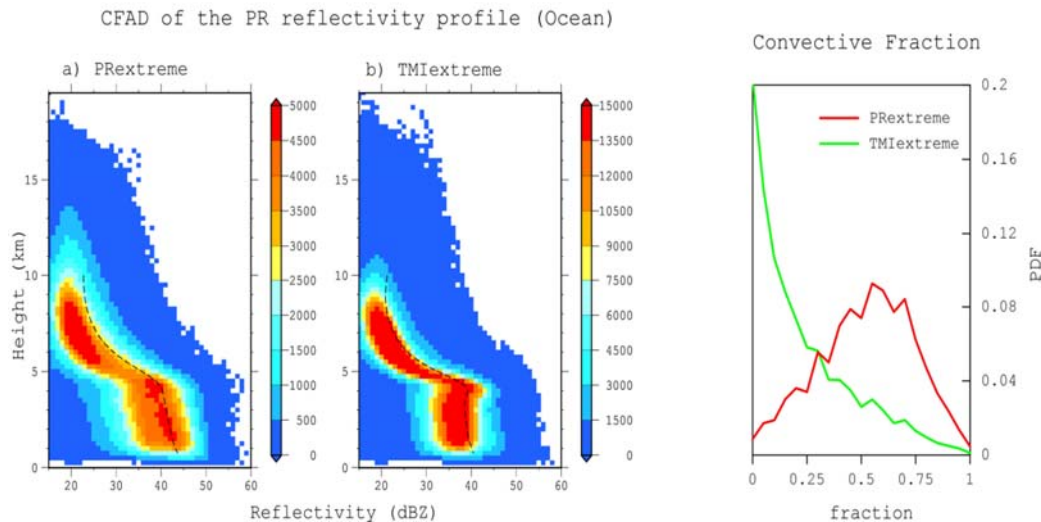

Figure 4. Difference of TRMM PR active sensor reflectivity over ocean (left) and its corresponding convective fraction between PR active sensor extreme and TMI passive sensor extreme events.

#### IV. Low cloud height extreme rain events identified by CloudSat

To clearly identify the discrepancies between active and passive sensors over ocean, comparison of CloudSat radar reflectivity data along the TRMM tracks were generated. Two snapshot representing an active sensor extreme and a passive sensor extreme rainfall are shown in Figure 5. At the upper left, an considerable rain-rate has been identified by the active sensor, but less for the passive sensor. At the lower left, the passive sensor identify a considerable amount of rainfall, as well as the active sensor. However, the extreme event identified by the passive sensor has larger humidity at a dense vertical column of the atmosphere, as shown in the lower right part of the figure.



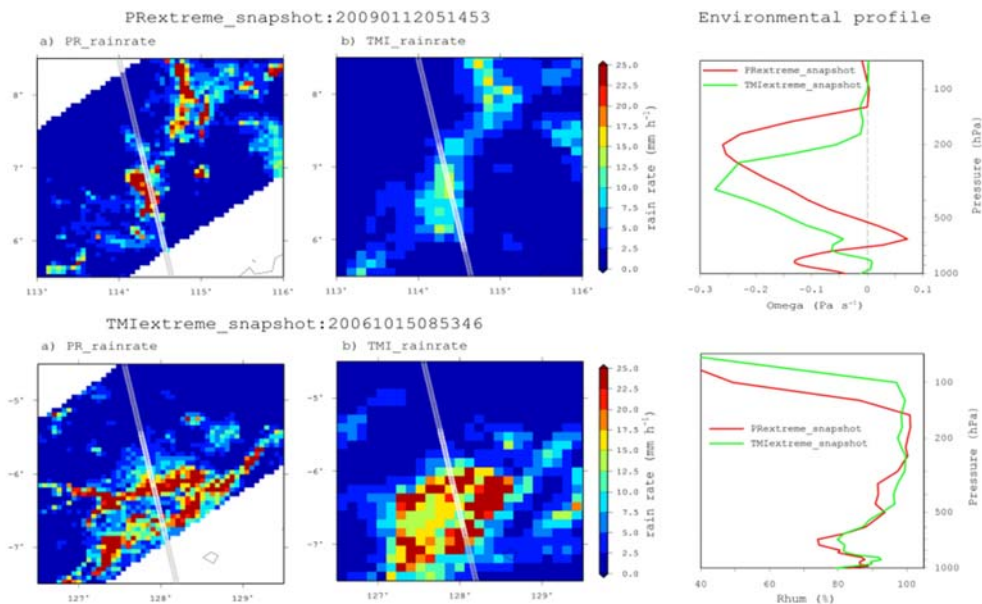

Figure 5. Two snapshots comparing TRMM PR active sensor extreme events (upper left) and TRMM TMI passive sensor events (lower left). Its corresponding vertical velocity and humidity are shown in the right part.

The result of the above comparison are shown in Figure 6. At the upper part, CloudSat reflectivity are shown, as well as the TRMM active sensor reflectivity at the lower part. The result shows a clear difference between the two types of extremes. At the left figure, it reveals that higher rain rate are not always have high cloud top, but possible to be occur at lower level, but with considerable amount of water content near the freezing height. At the right part of the figure, a higher cloud height are obtained by the passive sensor, however, it has less rain rate as identified from the bottom part. It means that although this kind of extreme seems to have a massive cloud structure, the amount of cloud particles washed out by rains are less.

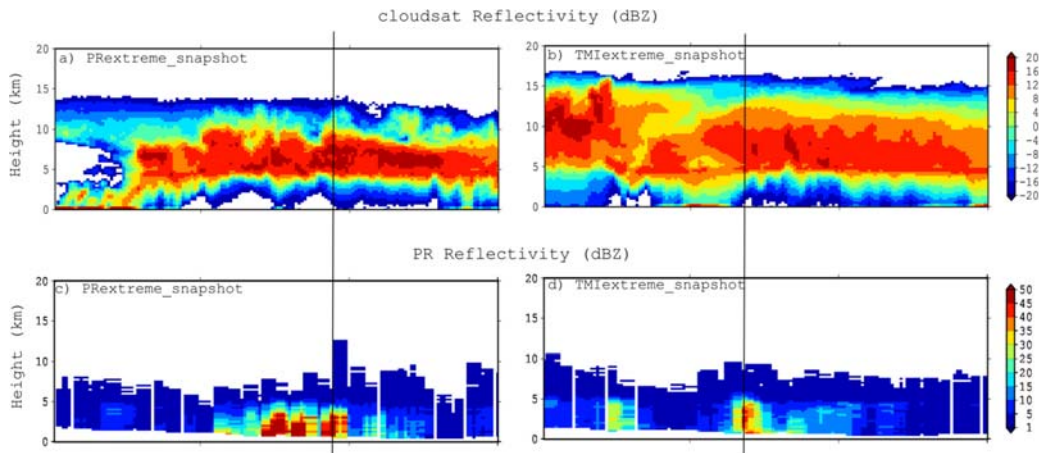

Figure 6. Comparison of CloudSat reflectivity (upper) and TRMM PR active sensor reflectivity (lower) of the two snapshots shown in Figure 5.

## V. Discussion and Conclusion: Sensor Discrepancies Corresponding to Cloud Phase

The main result in this research reveals that extreme rainfall over the Indonesian Maritime Continent have a weak association with the highest cloud. This condition is found from both land and ocean. Over ocean, the passive sensor often mistaken abundant ice particles over the upper troposphere as an indicator of heavy rainfall, whilst less water content found at the middle troposphere. Over ocean, tall structure of stratiform clouds with high humidity often mistaken as heavy rainfall condition. However, it is less precipitating at the lower level.

An interesting property related to heavy rainfall over the ocean as observed from the active sensor is that it has less water content over a dense vertical column, as identified from the passive sensor. This kind of extreme seems to have a considerable amount of water content at lower level, but less at upper level. This condition might be exist due to different cloud phase explained in Figure 1. In this case, the extreme might be occur further in decaying phase where intense collision and coalescence occur. Further investigation reveals that the low storm top height extreme has higher cloud effective radius due to the collision and coalescence process of the cloud particles, while for the tallest cloud structure identified by the passive sensor, a smaller radius are found, indicating a earlier stages of precipitation development. However, further investigation are required to address the detailed explanation of this process.

## References

- Hamada, A., Y. N. Takayabu, C. Liu, and E. J. Zipser, 2015: Weak linkage between the heaviest rainfall and tallest storms. *Nature Communications*,6, 6213, doi:10.1038/ncomms7213
- Iguchi, T., T. Kozu, R. Meneghini, J. Awaka, and K. Okamoto, 2000: Rain-profiling algorithm for the TRMM precipitation radar. *Journal of Applied Meteorology*,39(12), 2038-2052
- Kummerow,C., W.Barnes, T.Kozu, J.Shiue, and J.Simpson, 1998: The tropical rainfall measuring mission (TRMM) sensor package. *Journal of atmospheric and oceanic technology*, 15 (3),809-817
- Kummerow, C., and L. Giglio, 1994: A passive microwave technique for estimating rainfall and vertical structure information from space. Part I: Algorithm description. *Journal of Applied Meteorology*,33(1), 3-18
- NASA GFSC, 2014: Precipitation processing system Tropical Rainfall Measuring Mission: File specification for TRMM products, version 7.003. URL <http://pps.gsfc.nasa.gov/Documents/filespec.TRMM.V7.pdf>
- Shepherd, J. M. (2013). Impacts of urbanization on precipitation and storms: Physical insights and vulnerabilities.

**Topic :** Earth and Planetary Science

**Observation of geomagnetic fields changes related to  
9<sup>th</sup> March 2016 solar eclipse on Lombok Island-Indonesia**

Teti Zubaidah<sup>\*,a,b</sup>, Bulkis Kanata<sup>a,b</sup>, Paniran<sup>a,b</sup>, Giri Wahyu Wiriasto<sup>a,b</sup>

<sup>a</sup>*Research Group on Applied Electromagnetic Technology*

<sup>b</sup>*Electrical Engineering Department of Mataram University, Indonesia*

---

**Abstract**

It is known from hundreds years of researches that the geomagnetic fields are generated mainly by internal mechanisms in the Earth. Therefore, the fields are dominated by low-frequency from internal sources with small fractions of high-frequency from external sources, particularly the Sun. However, conclusions are not obtained, regarding which vector components are really related to the external or internal sources. Solar eclipse is a rare natural occurrence, where the Moon is temporarily shadowing the Sun, therefore the solar influence on geomagnetic fields should reach a minimum values. Thus meticulous geomagnetic observations conducted during a solar eclipse are expected to be able to answer the above questions. A solar eclipse has occurred on the Lombok Island on 9<sup>th</sup> March 2016, reached the totality of 82 %, occurred during 07:22 LT - 09:43 LT with a peak at 08:28 LT. We have conducted a continuous observations at the Lombok Geomagnetic Observatory, over a time span of one month (two weeks before and two weeks after the eclipse). We analyzed the fluctuations of vector components by taking comparisons with two other observatories; one in the nearest affected region (i.e. Kupang in Indonesia) and another one in the regions that are not affected by eclipse (i.e. Kakadu in Australia). Changes of vector directions are also observed by looking at the Declination and Inclination values, obtained from daily absolute measurements. The values are compared with the results of periodical absolute measurements, which have been conducted weekly at LOK during the last two years. The frequency spectrums of total magnetic fields are analyzed to obtain the changes of low-frequency components due to the eclipse occurrence. Data will be juxtaposed with observations of solar radiation and temperature in the observation room. The results showed that the total values of the magnetic fields tend to decrease (about 10 nT), with clear reductions in the values of X (Northing) and Y (Easting), while increases in Z (vertical) component. The absolute measurement results confirm the decreases of fields during eclipse time. They also show significant increase in declination and decrease in inclination. The increasing of declination, decreasing of inclination, and decreasing of total magnetic fields are clearly seen since three days before the eclipse.

**Keywords**

Geomagnetic; solar eclipse; declination; inclination; Lombok Island.

---

\* Corresponding author. Tel.: +62-817368685, E-mail: [tetizubaidah@te.ftunram.ac.id](mailto:tetizubaidah@te.ftunram.ac.id)

## 1. Introduction

The geomagnetic field measured at the Earth's surface is the superposition of contributions from external sources in the planetary environment (e.g. electric current flowing in the ionosphere and magnetosphere) and internal ones in its interior (e.g. fluid core, magnetization of rocks in the crust and induced currents in the Earth's interior by the time variations of the external fields), as described in detail by Olsen et al. (2010). Indeed, effort to separate contributions of internal and external sources has been performed firstly about 180 years ago by Carl-Friedrich Gauss (1839), who introduced the concept of spherical harmonic analysis. Since then, people came to the conclusion that by far the largest part of the field originates inside the Earth. However, according to Olsen et al. (2010), the sophisticated separation of these various sources and the accurate determination of the spatial and temporal structure of them is still a scientific challenge up today.

Solar eclipse is a rare natural occurrence, where the Moon is temporarily shadowing the Sun. During the eclipse time, therefore the solar influence on geomagnetic fields should reach a minimum values. Since the main external geomagnetic fields is generated by the Sun, thus meticulous geomagnetic observations conducted during a solar eclipse are expected to contribute in the efforts to separate and analyze the geomagnetic sources.

In this paper we present the results of one month continuous geomagnetic observations, conducted at the Lombok Geomagnetic Observatory (LOK), with the peak time of eclipse is placed right in the middle of the time span. All vector components values are analyzed to get the fluctuations related to eclipse. Comparisons are taken with two other observatories; in the nearest affected region (i.e. Kupang (KPG) in Indonesia) and another one in other regions that are not affected by eclipse (i.e. Kakadu (KDU) in Australia). Changes of vector directions are observed by looking at the Declination and Inclination values, which are obtained from daily absolute measurements. These absolute measurements have been taken exactly at the corresponding time to the peak time of eclipse. The values are compared with the results of periodical absolute measurements, which have been conducted weekly during the last two years.

Related to the separation of field sources, the frequency spectrums of total magnetic fields are analyzed to obtain the changes in the proportion of low-frequency parts due to the eclipse occurrence. Data will be juxtaposed with observations of solar radiation and temperature in the observation room.

By showing a good results of solar eclipse observations, we would like to introduce LOK as a new observatory operated in equatorial regions, which produces high quality variations and absolute data. The available data should be very useful for further studies related to geomagnetism, including earthquakes studies of this regions.

## 2. 9<sup>th</sup> March 2016 Solar Eclipse

A partial solar eclipse has been occurred over the Lombok Island (West Nusa Tenggara), with totality magnitude of 78% - 82%. At the location of Lombok Geomagnetic Observatory (LOK), it happened on 9<sup>th</sup> March 2016 from 07:22 LT to 09:43 LT (8<sup>th</sup> March 2016 at 23:22 UTC to 9<sup>th</sup> March at 01:43 UTC), with the maximum total phase at 08:28 LT (01:28 UTC). Path of the eclipse and locations of the three observatories are depicted in Fig. 1.

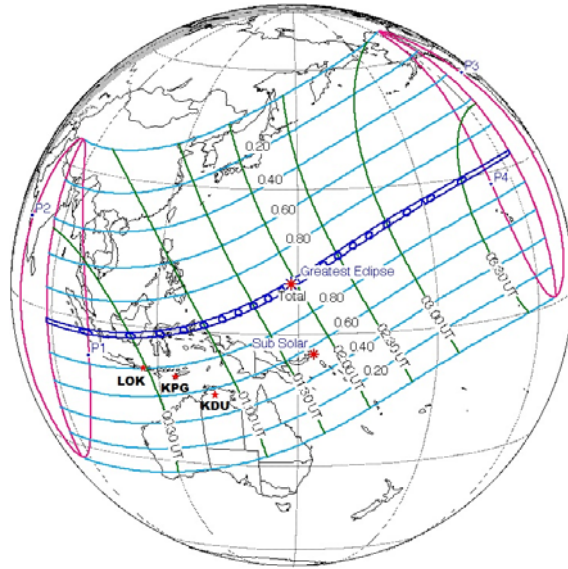

Figure 1. Path of the 9<sup>th</sup> March 2016 solar eclipse, with the location of three observatories, i.e. Lombok (LOK) and Kupang (KPG) in Indonesia, and Kakadu (KDU) in Australia. This figure is taken with modification from: [https://en.wikipedia.org/wiki/Solar\\_eclipse\\_of\\_March\\_9,\\_2016#](https://en.wikipedia.org/wiki/Solar_eclipse_of_March_9,_2016#)

### 3. Observation at Lombok Geomagnetic Observatory

#### 3.1. Fields Variation Recording

The following equipment are used for variation recording:

- (i) Three-axial suspended fluxgate magnetometer FGE (manufactured by DMI Copenhagen, Denmark), which measures geomagnetic variations in three directions of vector components (Horizontal, Declination, and Vertical).
- (ii) Overhauser proton magnetometer GSM90-F1 (manufactured by GEM Systems, Richmond Hill, Canada), which measures geomagnetic total intensities.
- (iii) GPS clock Telecode (manufactured by Precitel Neuchatel, Switzerland), which determines time automatically, synchronized with Universal Time Coordinate (UTC) using satellite.

Results of recordings are depicted in Fig. 2 to Fig. 5.

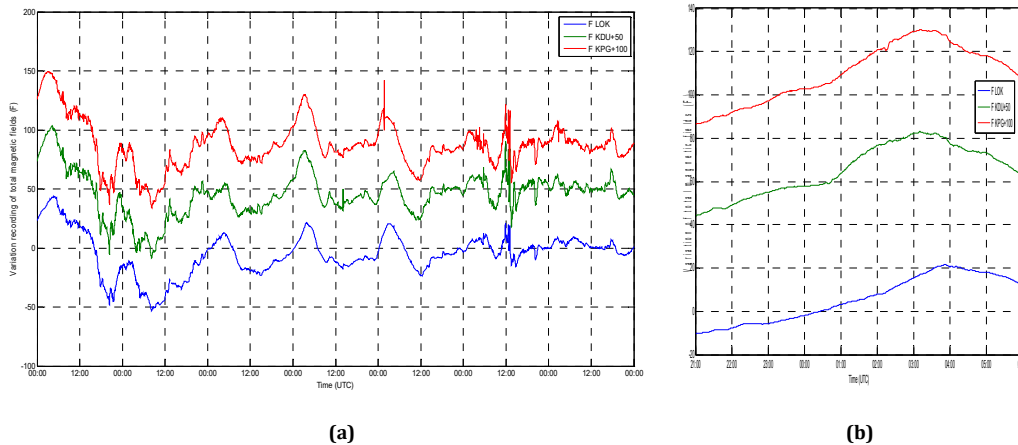
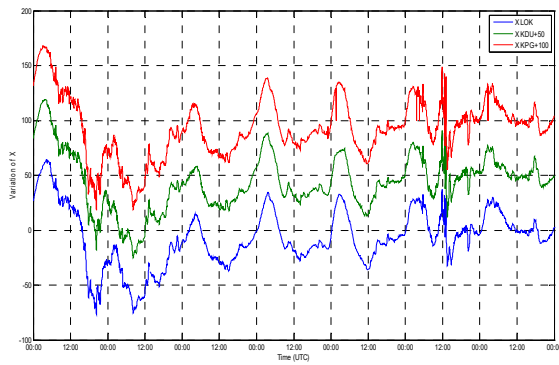
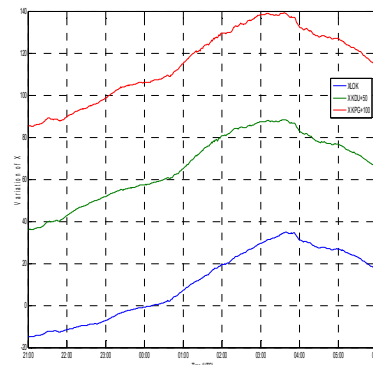

Figure 2. Variation recording of total magnetic fields (F) at LOK compared with KPG and KDU, (a) during one month observation (02.03.2016, 00:00 UTC - 16.03.2016, 23:59 UTC), and (b) during the eclipse time (8<sup>th</sup> March 2016 23:22 UTC - 9<sup>th</sup> March 01:43 UTC).



(a)



(b)

**Figure 3. Variation recording of Northing (X) component at LOK compared with KPG and KDU, (a) during one month observation (02.03.2016, 00:00 UTC - 16.03.2016, 23:59 UTC), and (b) during the eclipse time (8<sup>th</sup> March 2016 23:22 UTC - 9<sup>th</sup> March 01:43 UTC).**

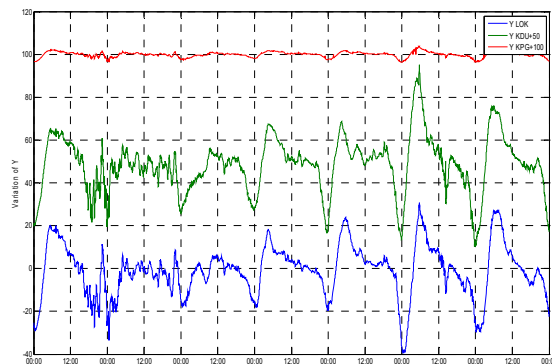

(a)

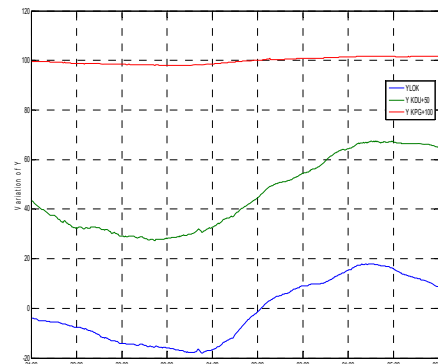

(b)

**Figure 4. Variation recording of Easting (Y) component at LOK compared with KPG and KDU, (a) during one month observation (02.03.2016, 00:00 UTC - 16.03.2016, 23:59 UTC), and (b) during the eclipse time (8<sup>th</sup> March 2016 23:22 UTC - 9<sup>th</sup> March 01:43 UTC).**

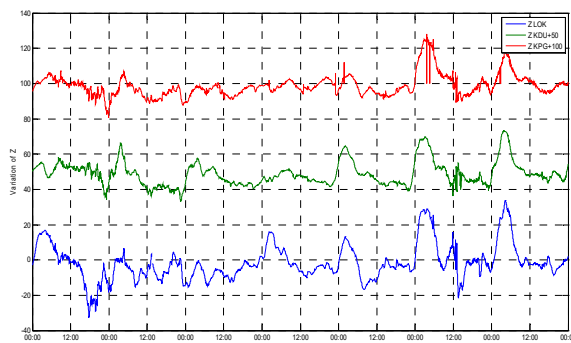

(a)

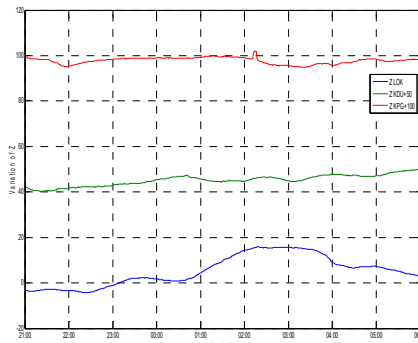

(b)

**Figure 5. Variation recording of Vertical (Z) component at LOK compared with KPG and KDU, (a) during one month observation (02.03.2016, 00:00 UTC - 16.03.2016, 23:59 UTC), and (b) during the eclipse time (8<sup>th</sup> March 2016 23:22 UTC - 9<sup>th</sup> March 01:43 UTC).**

### 3.2. Absolute Measurements

Absolute measurements have been conducted every day for one month, during two weeks before and two weeks after the eclipse. The measurements of declinations of each day have been taken around the time of maximum total phase. Especially for the day of eclipse, absolute measurements were taken three times, i.e. with the declinations measurements taken in the beginning phase, during maximum, and at the end of eclipse phase. Results of measurements are depicted in Fig. 6.

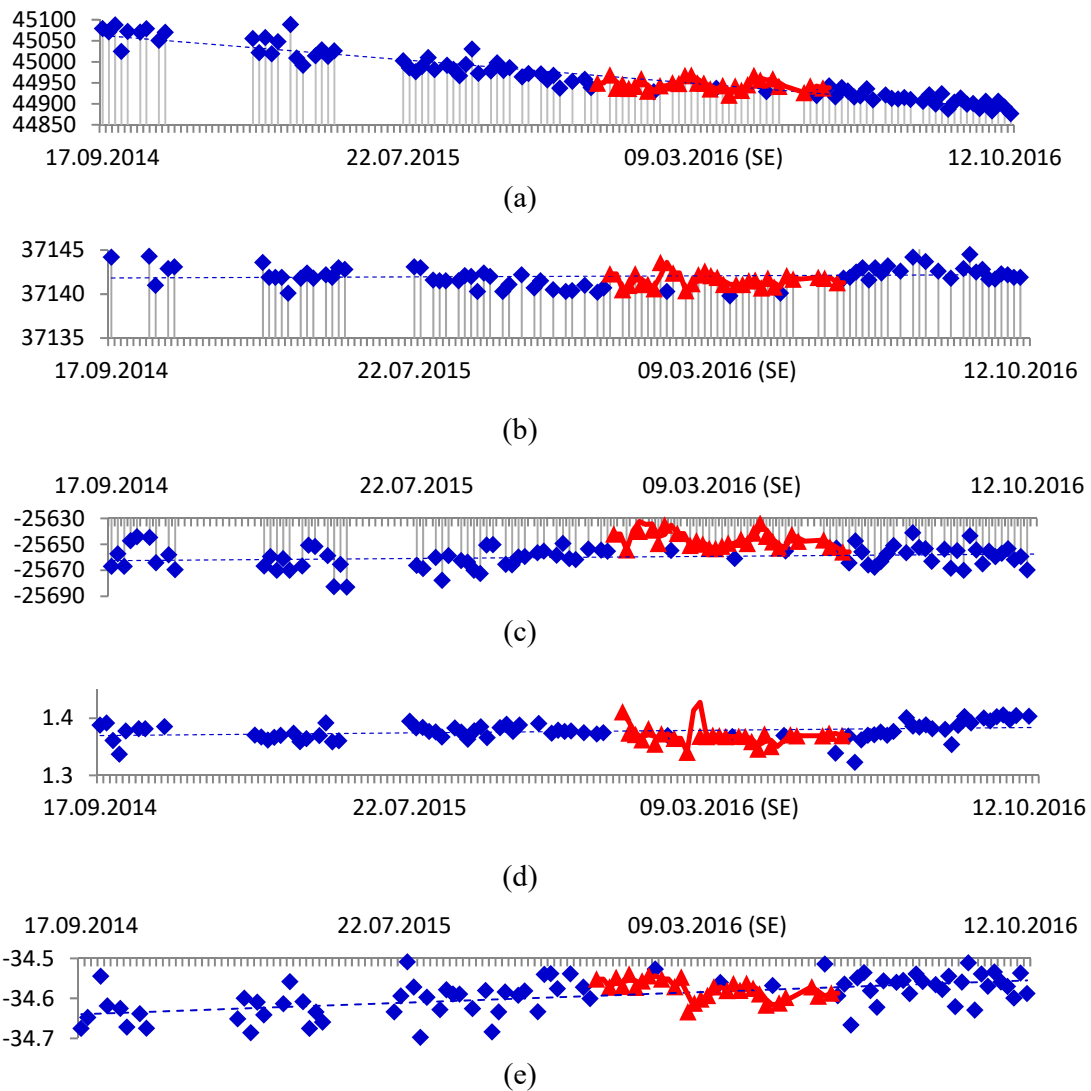

Figure 7 Blue points are results of weekly absolute measurements during two years time interval (17 September 2014 - 12 October 2016), with red ones are results of daily measurements during one month around the solar eclipse. All component are shown, with (a) Total, (b) Horizontal (c) Vertical and (d) Declination (e) Inclination.

### 3.3. Solar Radiation Measurements

Solar Radiations were observed using Phyranometer for one week, i.e. from three days before to three days after the eclipse, with the day of eclipse in the centre of time range. Results of measurements are depicted in Fig. 8, shows that solar radiation was quite low during eclipse time.



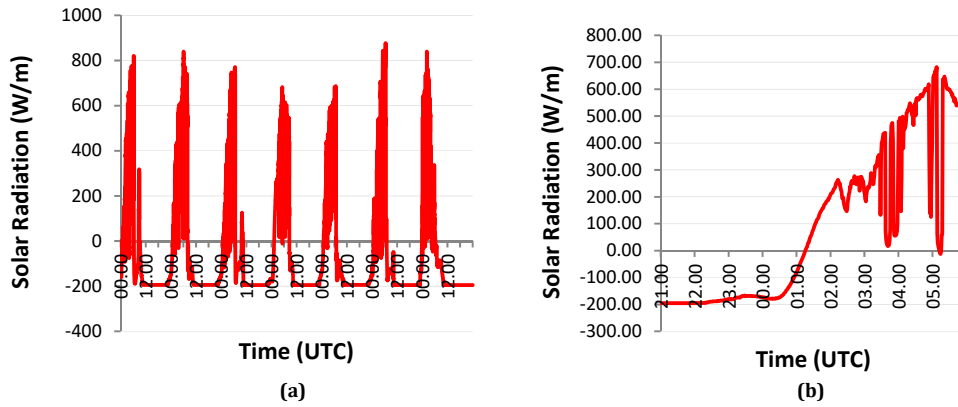

Figure 8. Variation recording of Solar Radiatin at LOK, (a) during 06.03.2016, 00:00 UTC - 12.03.2016, 23:59 UTC. (b) during 08.03.2016, 21:00 UTC - 09.03.2016, 05:59 UTC.

### 3.4. Temperature Measurements

Temperatures were measured in the Variation Room, as recorded by the data logger MAGDALOG, with 2 Hz time sampling and averaged in one-minute. Results of measurements are depicted in Fig. 9, which shows that the temperature were mainly stable during the observation days (27 - 29 °C). However, the temperature were slightly lower on the eclipse time.

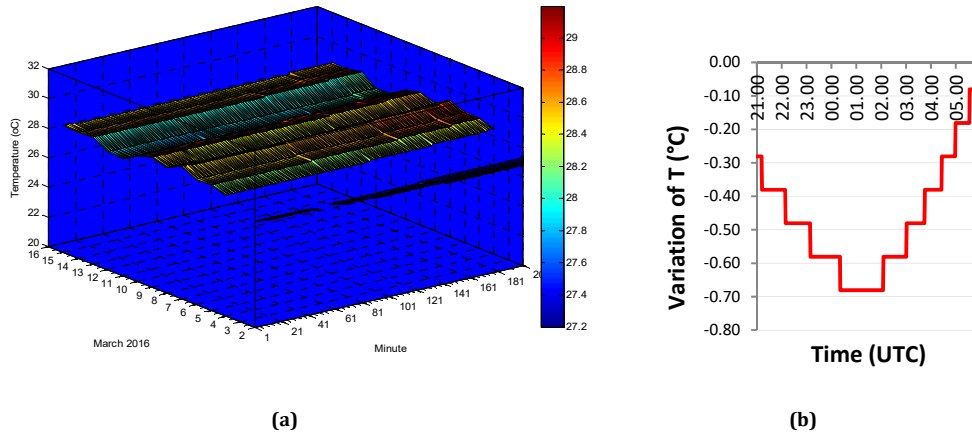

Figure 9. Variation recording of Temperature measured in the Variation Room of LOK, (a) during 02.03.2016-16.03.2016, and (b) during 08.03.2016, 21:00 UTC - 09.03.2016, 05:59 UTC.

## 4. Spectrum of Variation Recording

The variation recordings of total fields (F) are analyzed to get the spectrum for frequency range  $<0,04\text{Hz}$ . The normalized values of power spectral densities are reaching the maximum point of 2,645 on 6<sup>th</sup> March 2016 at  $f= 0$  Hz, while on other days are 1,062 on 2<sup>nd</sup> March at  $f= 0$  Hz, 1,264 on 9<sup>th</sup> March at  $f= 0$  Hz, 1,294 on 10<sup>th</sup> at  $f= 0$  Hz, 0,956 on 14<sup>th</sup> at  $f= 0$  Hz, and 1,348 on 15<sup>th</sup> at  $f= 0,0039$  Hz.

Results of spectrum analysis are depicted in Fig. 10. It can be concluded that the low frequencies are higher on the days before and after the eclipse. It means that the low frequency and contributions of internal sources to the total fields are reaching the minimum value on the solar eclipse day.

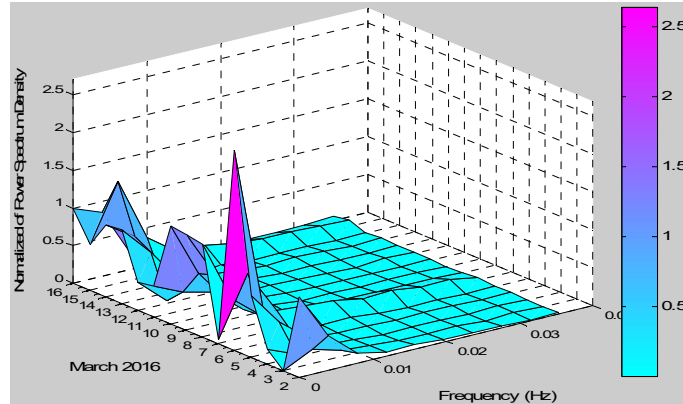

Figure 10. Power spectral density of total fields (F) for frequency range <0,04Hz

## 5. Discussions & Remarks

Among early study about geomagnetic fluctuation as an effect of the solar eclipse is done by Chapman (1933), who theoretically estimated the effect that should be expected to result from a solar eclipse. Afterward, Chapman and Bartels (1940) stated that partial eclipses (with more than 70 % of the Sun is obscured) may be little inferior, in their magnetic effects, to total eclipses. A quite long time after that, Cullington (1962) showed that the magnetogram traces recorded at Apia Observatory on the day preceding the eclipse, the day of the eclipse, and the day succeeding the eclipse. At the time of the eclipse there appears to have been a distinct decrease in the horizontal component, with maximum amplitudes of 10 nT in H, 0.6' in D, and 5 nT in Z.

Further studies of solar eclipse has been done by Ates et al. (2011), which resulted a decrease in the intensity of the magnetic field as observed during the total solar eclipse in 2006 in Turkey. Low-pass filtered magnetic data show peculiarity during the eclipse which can be correlated with the fluctuations in the gravity fields. During the previous eclipse on the same region, Korte et al. (2001) reported that no eclipse-related magnetic variations were observed from various parts of Europe. However, they found a magnetically quiet period with magnetic activity index  $K_p = 1$  around the solar eclipse. On the other hand, during the same previous eclipse, Malin et al. (2000) observed changes in the declination angle and a decrease of the intensity of the magnetic field.

Babakhanov et al. (2013) studied the effect in magnetic field by measuring the geomagnetic variations during a solar eclipse on 1 August 2008 in Rusia. They used standard instruments and comparing the results with measurements over the same time span at 18 INTERMAGNET observatories along shadow path from Canada to Japan. Some variations can be noted in the magnetic field in Novosibirsk with amplitude less than 5 nT, which is not reliable for being among geomagnetic variations of non-eclipse origin. The results for X component show negative anomalies for all mid-latitude observatories and the times of its extremes coincide with local totality.

Finally, Panda et al. (2015) studied the impact of 15 January 2010 solar eclipse, they refer to Espenak et al. (2006) who considered that the effects associated with a solar eclipse is always unique and emphasized the necessity to study any individual eclipses. It is because the solar eclipses may occur at various geographic locations during different phases of the solar activity, geomagnetic conditions, seasons, as well as local times of the day.

Continuous observations at LOK during one month around the day of solar eclipse on 9<sup>th</sup> March 2016 resulted decrease in total field value of about 10 nT or 0.02 % from the base value (results of absolute measurements during two years interval). This decreases are affected by reductions in the values of X (Northing) and Y (Easting), which are the components related to H (horizontal component). On the other hand, there was slightly increase in Z (vertical component). The frequency spectrum of total field showed decrease in low frequency (e.g. internal source) contribution. This decrease is about 52 % if compared to the maximum spectral reached on another day.

The absolute measurement results show significant increase in declination and decrease in inclination, and clearly confirm the decreases of fields during eclipse time. These decrease of total fields is more prominent in comparison with the normal decrease during non-eclipse days. The fluctuations of declination, inclination, and total magnetic fields are clearly seen since three days before the eclipse.

The results of solar eclipse observations in our current study is more thoroughly compared to the previous eclipse studies. It is really supported by high quality data, obtained by high resolution of equipment, as well as well done procedures of measurements. Based on the consistency of results which are supported by high quality data, we really confident to use LOK data for the future studies which need sensitive analysis, such as earthquake precursors.

## Acknowledgements

The results presented in this paper rely on the data collected at Kakadu (KDU). We thank to Geoscience Australia (GA) for supporting their operations and INTERMAGNET for promoting high standards of magnetic observatory practice ([www.intermagnet.org](http://www.intermagnet.org)). We also thank to BMKG Stage of Kupang for providing Kupang (KPG) data. MATLAB ® with license number 863485 is used for data processing. Funding for this research is provided by Indonesian Ministry of Research, Technology and Higher Education under *Penelitian Unggulan Perguruan Tinggi (PUPT) 2016*, entitled *Observasi Geomagnetik dan Seismologi Terpadu di Pulau Lombok: Kontribusi untuk Pemodelan Global dan Mitigasi Bencana Gempa Bumi Wilayah Indonesia Timur*. Contributors of this paper are: Misbahuddin, Rosmaliati, Budi Irmawati, Made Sutha Yadnya, Abdullah Zainuddin, L.A.S. Irfan Akbar, A. Sjamsjiar Rachman, M. Syamsu Iqbal, Cipta Ramadhani. The authors would like to thank to the students of Electrical Engineering Dept. of Mataram University, who carried out the absolute measurements at LOK.

## References

- Ates, A., Buyuksarac, A., Bekta, O. (2011). Geophysical Variations during the Total Solar Eclipse in 2006 in Turkey. *Turkish Journal of Earth Sciences*, Vol. 20, pp. 337-342.
- Babakhanov, I.Y., Belinskaya, A.Y., Bizin, M.A., Grekhov, O.M., Khomutov, S.Y., Kuznetsov, V.V., Pavlov, A.F. (2013). The geophysical disturbances during the total solar eclipse of 1 August 2008 in Novosibirsk, Russia. *Journal of Atmospheric and Solar-Terrestrial Physics*, Vol. 92, pp. 1-6.
- Chapman S. (1933). The Effect of a Solar Eclipse on the Earth's Magnetic Field. *Terr. Magn. Atmos. Elect.*, Vol. 38, pp. 175-83.
- Chapman, S. and Bartel, J. (1940). *Geomagnetism*, Vols. 1 and 2, pp. 354, 794-798.

- Cullington, A.L. (1962). Geomagnetic effects of the solar eclipse, 12 October 1958, at Apia, Western Samoa, New Zealand. *Journal of Geology and Geophysics*, Vol. 5, No. 3, pp. 499-507.
- Espenak, F., Meeus, J., Center, G.S.F., Aeronautics, U.S.N., Administration, S. (2006). Five Year Millennium Canon of Solar Eclipses: -1999 to +3000 (2000 BCE to 3000 CE). NASA technical paper, NASA Goddard Space Flight Center.
- Gauss, C.F. (1839). *Allgemeine Theorie des Erdmagnetismus, Resultate aus den Beobachtungen des Magnetischen Vereins im Jahre 1838*, Göttinger Magnetischer Verein, Leipzig, pp. 1-52.
- Korte, M., Luehr, H., Forster, M., Haak, V. (2001). Did the solar eclipse of August 11, 1999, show a geomagnetic effect? *Journal of Geophysical Research*, Vol. 106, No. A9, pp. 18563-18575.
- Lepidi, S., Francia, P., De Lauretis, M. (2001). Local time behaviour of low frequency geomagnetic fields fluctuation power at low latitude. *Annals of Geophysics*, Vol. 44, No. 1, pp. 119-126.
- Lepidi, S., Cafarella, L., Francia, P., Meloni, A., Palangio, P., Schott, J.J. (2003). Low frequency geomagnetic field variations at Dome C (Antarctica). *Annals of Geophysics*, Vol. 21, pp. 923-932.
- Malin, S.R.C., Ozcan, O., Tank, S.B., Tunger, M.K, Yazicicakin, O. (2000). Geomagnetic signature of the 1999 August 11 total eclipse. *Geophysical Journal International*, Vol. 140, pp. F13-F16.
- Olsen, N., Glassmeier, K.H., Jia, X. (2010). Separation of the Magnetic Field into External and Internal Parts. *Space Sci Rev*, Vol. 152, pp. 135-157.
- Panda, S.K., Gedam, S.S., Rajaram, G., Sripathi, S., Bhaskar, A. (2015). Impact of 15 Jan 2010 annular solar eclipse on the equatorial and low latitude ionosphere over Indian region from Magnetometer, Ionosonde and GPS observations. *Journal of Atmospheric and Solar-Terrestrial Physics*, Vol. 135, pp. 181-191.

---

## **Development of Synthetic Aperture Radar onboard Aircraft and Microsatellite for Global Land Deformation Observation**

Josaphat Tetuko Sri Sumantyo <sup>a,\*</sup>, Nobuyoshi Imura <sup>a</sup>  
and Robertus Heru Triharjanto <sup>b</sup>

<sup>a</sup> Center for Environmental Remote Sensing, Chiba University, Japan

<sup>b</sup> National Institute of Aeronautics and Space, Indonesia

---

### **Abstract**

Synthetic Aperture Radar (SAR) is well-known as a multi-purpose sensor that can be operated in all-weather and day-night time. As our laboratory roadmap for microsatellite, aircraft, and unmanned aerial vehicle development, our laboratory develops synthetic aperture radar (SAR), especially Circularly Polarized Synthetic Aperture Radar or Elliptically Polarized Synthetic Aperture Radar (CP-SAR or EP-SAR, Patent Pending 2014-214905) to monitor global land deformation. The sensor is designed to transmit and receive left-handed circular polarization (LHCP) and right-handed circular polarization (RHCP). For this purpose, we also develop unmanned aerial vehicle (UAV) for ground experiment of this sensor. The main mission of CP-SAR is to hold the basic research on elliptically polarized scattering and its application developments. In the basic research, we will investigate the elliptical (including circular and linear polarizations) scattering wave from the land surface, generation of axial ratio image (ARI), ellipticity and tilted angle images etc. We will hold the analysis and experiment of circularly polarized wave scattering on vegetation, snow, ice, soil, rock, sand, grass etc to investigate the elliptical scattering wave. These images will be extracted by using the received RHCP and LHCP wave. CP-SAR sensor transmits only one polarization, RHCP or LHCP, then this sensor will receive RHCP and LHCP scattering waves simultaneously. The image is employed to investigate the relationship between the physical characteristics of vegetation, soils, snow etc. The image of tilted angle as the response of land surface also will be extracted to mapping the physical information of the surface, i.e. geological matters etc. In application development, CP-SAR sensor will be implemented for land cover mapping, disaster monitoring, Cryosphere monitoring, oceanographic monitoring etc. Especially, land cover mapping will classify the forest and non-forest area, estimation of tree trunk height, mangrove area monitoring, Arctic and Antarctic environment monitoring etc. In disaster monitoring, CP-SAR sensor will be employed for monitoring of earthquake area, volcano activity, landslide etc. This paper introduces progress on development of our SAR onboard Boeing 737-200 aircraft and microsatellite.

### **Keywords**

Microsatellite, synthetic aperture radar, CP-SAR, UAV, Aircraft

---

\* Corresponding author. Tel.: +81(0)43 290 3840; fax: +81(0)43 290 3857  
E-mail address: jtetukoss@faculty.chiba-u.jp

# 1. Introduction

Synthetic Aperture Radar (SAR) is well-known as a multi-purpose sensor that can be operated in all-weather and day-night time. As our laboratory roadmap for microsatellite, aircraft, and unmanned aerial vehicle development (refer Fig. 1), our laboratory develops SAR, especially Circularly Polarized Synthetic Aperture Radar or Elliptically Polarized Synthetic Aperture Radar (CP-SAR or EP-SAR, Patent Pending 2014-214905) to monitor global land deformation. The sensor is designed to transmit and receive left-handed circular polarization (LHCP) and right-handed circular polarization (RHCP), see Fig.2. For this purpose, we also develop unmanned aerial vehicle (UAV) for ground experiment of this sensor (Sri Sumantyo 2011 & 2012), see Fig.3 and Fig.4.

The main mission of CP-SAR is to hold the basic research on elliptically polarized scattering and its application developments. In the basic research, we will investigate the elliptical (including circular and linear polarizations) scattering wave from the land surface, generation of axial ratio image (ARI), ellipticity and tilted angle images etc. We will hold the analysis and experiment of circularly polarized wave scattering on vegetation, snow, ice, soil, rock, sand, grass etc to investigate the elliptical scattering wave. These images will be extracted by using the received RHCP and LHCP wave. CP-SAR sensor transmits only one polarization, RHCP or LHCP, then this sensor will receive RHCP and LHCP scattering waves simultaneously. The image is employed to investigate the relationship between the physical characteristics of vegetation, soils, snow etc. The image of tilted angle as the response of land surface also will be extracted to mapping the physical information of the surface, i.e. geological matters etc.

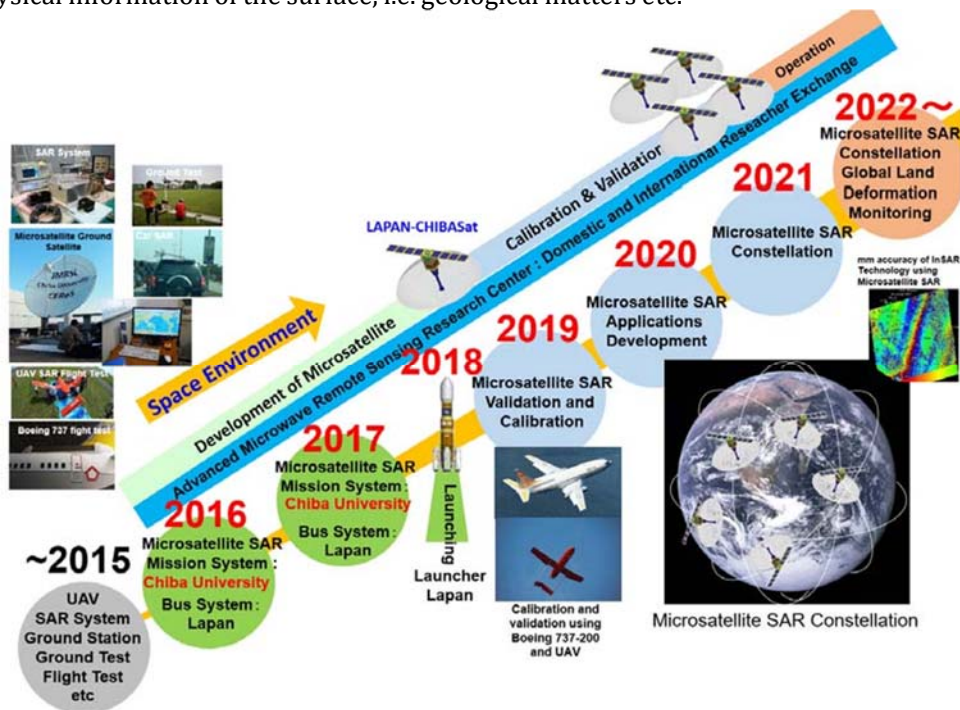

Fig.1. Roadmap of Chiba University Microsatellite

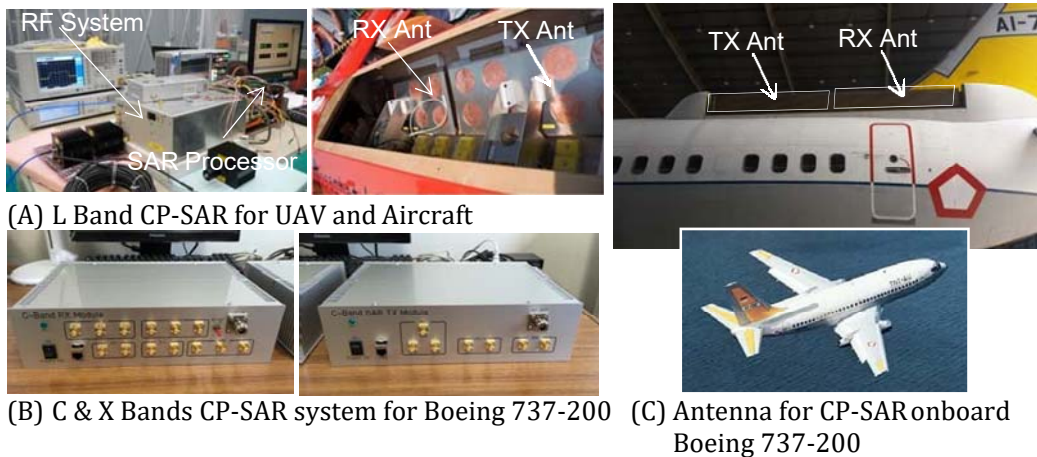

Fig. 2. Circularly Polarized Synthetic Aperture Radar (CP-SAR) onboard Boeing 737-200



Fig. 3. Flight test of CP-SAR onboard UAV JX-1 at Fujikawa Airport, Japan on 29 August 2013.



Fig. 4. The 2nd Josaphat Laboratory Experimental Unmanned Aerial Vehicle (JX-2) for microwave sensor ground test

In application development, CP-SAR sensor will be implemented for land cover mapping, disaster monitoring, Cryosphere monitoring, oceanographic monitoring etc. Especially, land cover mapping will classify the forest and non-forest area, estimation of tree trunk height, mangrove area monitoring, Arctic and Antarctic environment monitoring etc. In disaster monitoring, CP-SAR sensor will be employed for monitoring of earthquake area, volcano activity, landslide etc. This paper introduces progress on development of our SAR onboard Boeing 737-200 aircraft and microsatellite.

## 2. CP-SAR Onboard Aircraft

The CP-SAR onboard Aircraft (Fig. 5) is mainly composed by Flight Control System, Telemetry and Command Data Handling, Attitude Controller, and Sensors. Attitude Controller is composed by Inertial Measurement Unit (IMU) and GPS units. Sensors are composed by CP-SAR as main mission sensor, and other sensors. CP-SAR sub-system itself is composed by chirp pulse generator module, Transmitter and Receiver (Tx-Rx) module, and Image Signal Processing module. Ground control segment was used for CP-SAR sensor monitoring and image processing. The CP-SAR system is composed by transmitter and receiver sub modules. The input of transmitter is In-phase (I) and Quadrature (Q) signal of chirp pulse generated by pulse generator with baseband range is DC to 150 MHz (normally 50 MHz), 400 MHz, and 800 MHz for L, C and X band, respectively. Then chirp

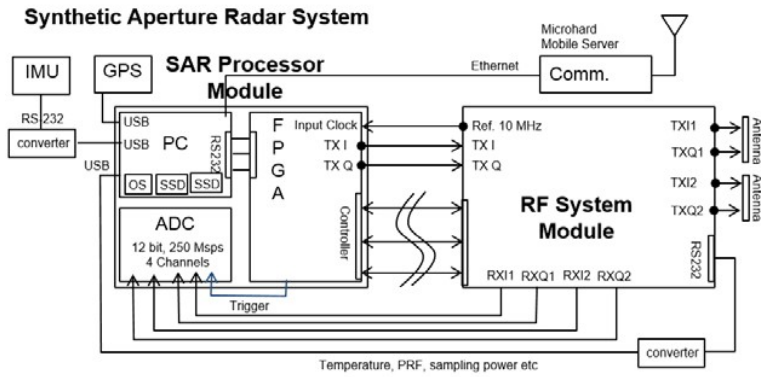

Fig. 5. Aircraft onboard CP-SAR System

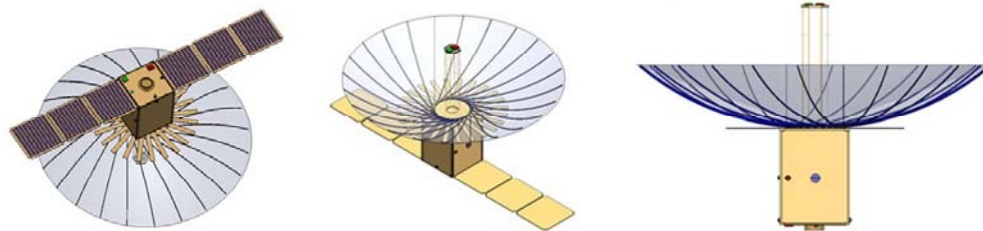

Fig. 6. Microsatellite CP-SAR



Fig. 7. Deployment experiment of meshed parabolic antenna

pulse is modulated by frequency 1,270 MHz, 5,600 MHz, and 9,400 MHz, respectively. The transmission system has gain tuning function as 1, 2, 3, 8, 16 dB or 0 to -31 dB, and receiver has gain tuning function as 1, 2, 3, 8 and 16 x 2 or 0 to -62 dB. Power amplifier (PA) is available to control pulse transmission output power 50 W, 400 W and 1000 W respectively with pulse width maximum 10  $\mu$ s, and maximum duty circle is 2%. The switching speed of transmission and receiver system antennas (RHCP and LHCP) is typically 1  $\mu$ s and maximum 2  $\mu$ s. The antenna is composed by two sets of CP microstrip array antenna (LHCP and RHCP panels), totally 4 panels to realize full polarimetric CP-SAR sensor. We could control the pulse length and bandwidth of chirp pulse, and save data to SSD memory.

In this research, the CP-SAR onboard unmanned aerial vehicle (CP-SAR UAV, Fig. 3 and 4) is developed for ground testing of CP-SAR and other sensors. The platform called Josaphat Laboratory Experimental UAV (JX-1 and JX-2) has 25 kg of payload. The operation altitude is 1,000 m to 4,000 m. The specification of CP-SAR sensor for UAV is frequency of L, C and X bands, ground resolution up to 1 m, pulse length could be tuned from 4.5 to 48  $\mu$ s, off nadir angle 30 $^{\circ}$  to 60 $^{\circ}$ , swath width 1 km, 4 panels of antenna, and PRF 1,000~2,500 Hz. We held ground experiment with altitude less than 2 km with pulse transmission output power 50 W for L band, 4 km with output power 400 W for C band, and 10 km with output power 1000 W for X band, respectively. The data retrieved by LHCP and RHCP antenna (Yohandri 2011) is employed to investigate the characteristics of elliptical polarization, including circular and linear polarizations. In the future, further investigation of characteristics of circular polarization will be done by using Boeing 737-200 aircraft.



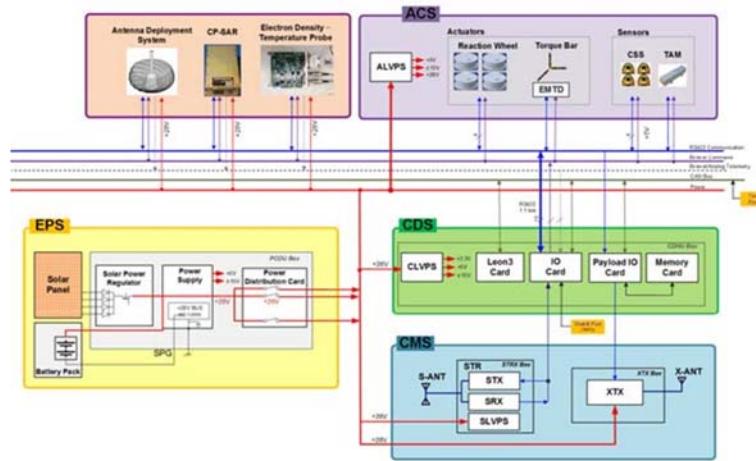

Fig. 8. Modules of Microsatellite CP-SAR

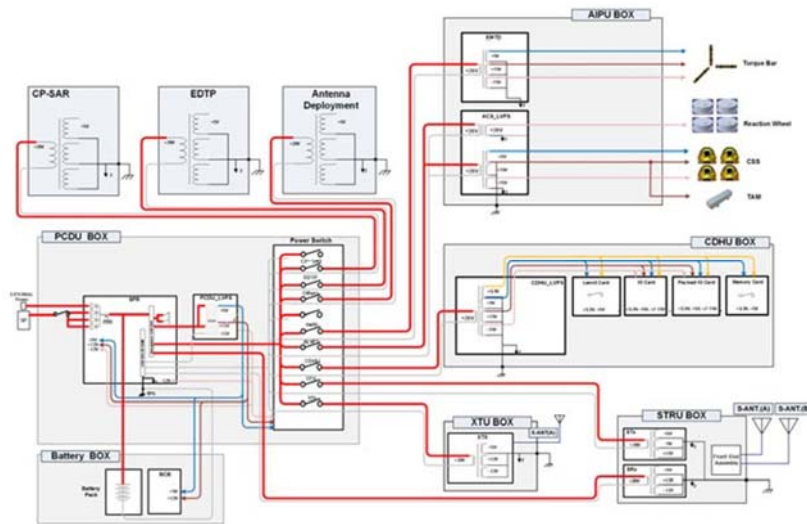

Fig. 9. Power network of CP-SAR microsatellite

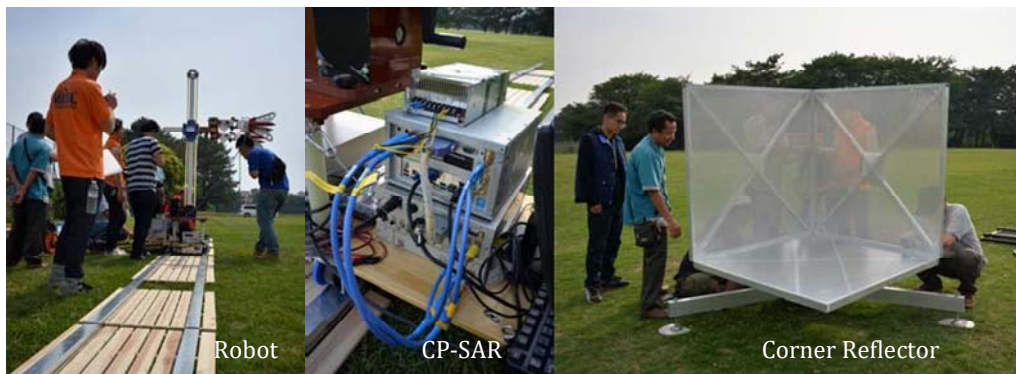

Fig. 10. Ground test of CP-SAR system for UAV



Fig. 11. Ground station for our microsatellite CP-SAR

### 3. Microsatellite CP-SAR

Fig. 6 shows model of CP-SAR onboard microsatellite (Microsatellite CP-SAR, 100 kg class) that developed in Josaphat Microwave Remote Sensing Laboratory (JMRS), Center for Environmental Remote Sensing, Chiba University. We proposed meshed parabolic antenna to reduce weight of SAR system to realize 100 class SAR onboard microsatellite. Fig. 7 shows deployment experiment of meshed parabolic antenna of Microsatellite CP-SAR. Fig. 8 shows microsatellite is composed by Command and Data Handling Sub-system (CDS), Communication Subsystem (CMS), Electrical Power Subsystem (EPS), Altitude Control Subsystem (ACS) and payload. CDS uses Leon3 card, low power supply card (LVPS), IO card, payload IO card, and non-volatile memory card. CMS is composed by LVPS, low power supply card, S band transmitter & receiver (STX and SRX) and antenna for telemetry, X band transmitter and antenna for data downlink. EPS is composed solar panel, solar power regulator, power supply card, power distribution card, Li-Ion battery pack and battery control card. ACS employs LVPS, actuators (reaction wheels assembly-RWA and electromagnetic torque bar-EMTB) and sensors (coarse sun sensor-CSS and three-axis magnetometer-TAM), and GPS Receiver-GPSR. Payload is composed by main sensor CP-SAR for Earth surface monitoring and minor sensors: electron density - temperature probe (EDTP) for ionospheric monitoring. Power network of our microsatellite is shown on Fig. 9. We also develop SAR ground test measurement system as shown on Fig. 10, with moving precision of robot is 0.1 mm.

We also develop sub mission sensors, i.e. GPS-RO and electron density - temperature probe (EDTP) to monitor ionospheric phenomena. We will employ these ionospheric observation sensors simultaneously with our CP-SAR to monitor ionosphere and global land deformation. Therefore we could mapping pre-cursors of earthquake by using our microsatellites in the future.

### 4. Ground Station

Fig. 11 shows our satellite ground station with S band for command-telemetry and X band for mission data downlink. The 3.6m diameter of antenna and main control room of satellite ground station locates at Center for Environmental Remote Sensing, Chiba University. Command Unit (S band) has output power 100 Watts, frequency 2,025 to 2,120 MHz, LHCP and PCM, BPSK, PM and FSK modulations, and bitrate 1,024 BPSK, 9.6 kbps FSK. Telemetry Unit (S Band) works with frequency 2,200 to 2,300 MHz, LHCP and PCM, BPSK, PM and FSK modulations, bitrate 2.4 Mbps BPSK, 38.4 kbps FSK. Data Receiver Unit (X band) works with frequency 8,025 to 8,300 MHz, LHCP, QPSK modulation, bitrate 20 Mbps QPSK.

## 5. Summary

In this paper, we introduce the progress of development on CP-SAR onboard UAV, Boeing 737-200 aircraft, and microsatellite in our laboratory. The CP-SAR sensor is designed as small, lightweight and low power consumption system. The CP-SAR sensor is developed to radiate and receive elliptically polarized wave, including circularly and linearly polarized waves. In the near future, this sensor will be installed on Boeing 737-200 aircraft and microsatellite that will be applicable for land cover mapping, disaster monitoring, snow cover and oceanography monitoring etc. We also develop ionospheric observation sensors that is introduced in this paper too. In the future, these sensors could be employed for observation of ionosphere and global land deformation simultaneously for disaster monitoring and prediction.

## Acknowledgement

Josaphat Microwave Remote Sensing Laboratory (JMRS�) thanks to Chiba University Global Prominent Research Program; the Japan Society for the Promotion of Science (JSPS); the Japanese Ministry of Education and Technology (Monbukagakusho) No. 2114K042527 and No. 2101; JICA-JST SATREPS Program, Bhimasena, Indonesian Aerospace Agency (LAPAN) etc for supporting this research.

## References

- Sri Sumantyo, J.T. (2011), "Microwave Remote Sensing Research and Education at Center for Environmental Remote Sensing, Chiba University," IEEE Geoscience and Remote Sensing Society (GRSS) Newsletter, Issue #159, pp. 32-38.
- Sri Sumantyo, J.T. (2012), Chapter 11. Circularly Polarized Synthetic Aperture Radar onboard Unmanned Aerial Vehicle (CP-SAR UAV), *Autonomous Control Systems and Vehicles*, Kenzo Nonami edn., Springer.
- Yohandri, V. Wissan, I. Firmansyah, P. Rizki Akbar, J.T. Sri Sumantyo, and H. Kuze, (2011)"Development of Circularly Polarized Array Antenna for Synthetic Aperture Radar Sensor Installed on UAV," *Progress in Electromagnetics Research C*, Vol. 19, pp. 119-133.

**Topic :** Remote Sensing

**Phase Coded Stepped Frequency Linear Frequency Modulated  
Waveform Synthesis Technique for Ultra-Wideband Synthetic  
Aperture Radar**

CHUA Ming Yam<sup>a,\*</sup>, KOO Voon Chet<sup>a</sup>, LIM Heng Siong<sup>a</sup>, Chan Yee Kit<sup>a</sup>, Josaphat  
Tetuko Sri Sumantyo<sup>b</sup>

<sup>a</sup>*Faculty of Engineering and Technology, Multimedia University, Jalan Ayer Keroh Lama,  
75450 Bukit Beruang, Melaka, Malaysia*

<sup>b</sup>*Josaphat Microwave Remote Sensing Laboratory (JMRS), Center for Environmental  
Remote Sensing, Chiba University, 1-33 Yayoi, Inage, Chiba 263-8522 Japan*

---

**Abstract**

This paper presents the design work of Phase Coded (PC) Stepped Frequency Linear Frequency Modulated (SF<sub>c</sub>-LFM) technique targeted for use in Ultra-Wide Band (UWB) Synthetic Aperture Radar (SAR). The technique is a hybrid approach that employs digital waveform synthesis technique for baseband LFM pulse generation and analogue microwave up-conversion technique. In this work, a train of phase coded baseband LFM pulses is generated using a custom designed Field Programmable Gate Array (FPGA) waveform synthesis board and each baseband pulses are then up-converted to different adjacent band in the carrier band. The collected train of pulses is then re-combined and processed, to synthesis an ultra-wideband pulses. The experimental results show that the technique is able to synthesize a UWB SAR LFM pulse signal. The main advantage of the technique is its capability to improve existing SAR system resolution without having to increase the baseband bandwidth of the system.

**Keywords**

Keywords: UWB; SAR; Linear FM; Stepped-Frequency; Signal Synthesis.

---

**1. Introduction**

SAR is a modern radar system that utilizes pulse compression technique to improve its system resolution whilst maintaining the pulse width of the signal (Skolnik, 1970; Ulaby et. al, 1981). It uses match-filtering technique to compress a wide pulse into a very narrow impulse response (Barton, 1988; Mahafza, 1998). SAR system has stringent requirement in its signal Time Bandwidth Product (TBP). The TBP determines the pulse compression ratio, which is the quantitative measure on the system's range resolution.

Conventionally, a large bandwidth signal can be synthesised using a Voltage Controlled Oscillator (VCO). However, this method is not suitable for SAR signal synthesis as the VCO has a very slow sweep time (Chan and Lim, 2008). On the other hand, due to the limitation in DACs sampling speed, the digital approach is more suitable for low bandwidth (< 100 MHz) signal synthesis applications. Furthermore, increasing the DACs sampling speed introduces new issues in hardware system design, and also increases the

---

\* Corresponding author. Tel.: +85-070-4328-9428  
E-mail address: mychua@chiba-u.jp

requirement of Analogue-to-Digital Converter (ADC) sampling speed and system bus data transfer rate.

In order to solve the problem, a new technique on Phase Coded Stepped Frequency Linear FM (SF<sub>c</sub>-LFM) method is proposed for Ultra-Wide Band (UWB) SAR signal generation.

## 2. Phase Coded SF<sub>c</sub>-LFM Waveform Synthesis Technique

In traditional, SAR transmits a single burst baseband LFM pulse at every Pulse Repetition Interval (PRI). The transmitted pulse is in its carrier frequency,  $f_c$ , given as,

$$x_{tx}(t) = \Pi\left(\frac{t}{T}\right) \cdot e^{j\pi(\alpha t^2 - Bt)} \cdot e^{j2\pi f_c t} \quad (1)$$

In the proposed Phase Coded SF<sub>c</sub>-LFM technique, multiple burst of phase coded LFM pulse (or known as intra-pulses) was transmitted, for every SAR PRI interval. They were separated by an intra-PRI interval,  $t_{pri\_int}$  so that the current listening echo does not overlap with the transmission of the succeeding pulse. Figure 1(a) illustrates an example of the time-frequency plot for 4 burst SF<sub>c</sub>-LFM waveform and Figure 1(b) shows an example of the time domain plot of these pulses. Equation below formulates SF<sub>c</sub>-LFM signals where each intra-pulses were phase coded.

$$x_{pc}(t_m) = A \cdot \sum_{n=1}^N u_b(n) \cdot \Pi\left(\frac{t_m}{T}\right) \cdot e^{j\pi(\alpha t_m^2 - Bt_m)} \quad (2)$$

where,

$N$  = number of transmitted pulse within an PRI interval

$n$  = integer number of 1,2,3 ... N

$t_m = t - (n - 1)t_{pri\_int}$

$t_{pri\_int}$  = intra pulse PRI

$u_b(n)$  = the implemented phase coding scheme

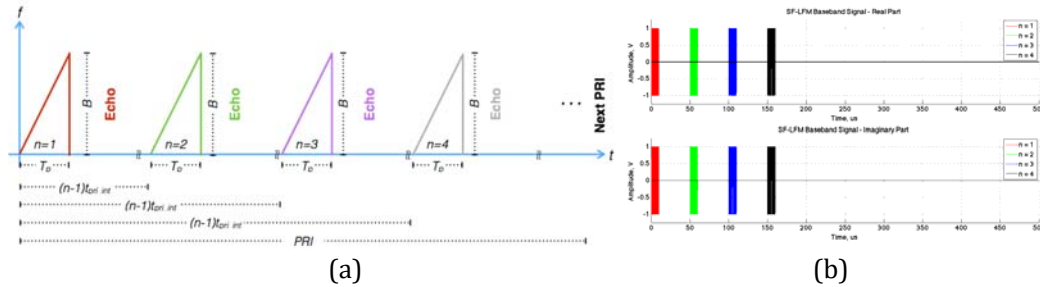

Figure 1: (a) Time-Frequency Plot for SF<sub>c</sub>-LFM (n=4), (b) Time-Domain Plot for SF<sub>c</sub>-LFM Baseband Pulses (n=4)

In the proposed technique, each phase coded intra-pulses were mixed with different adjacent carrier frequencies. For design simplicity, an assumption is made that only even number of intra-pulses are transmitted ( $N$  is an even number and  $N > 2$ ). Thus, the up-converted signals then can be further expressed as,

$$x_{pc\_rf}(t_m) = A \cdot \sum_{n=1}^N u_b(n) \cdot \Pi\left(\frac{t_m}{T}\right) \cdot e^{j\pi(\alpha t_m^2 - Bt_m)} \cdot e^{j2\pi f_n t_m} \quad (3)$$

where  $f_n$  is the desired adjacent carrier frequency denoted as,

$$f_n = f_c + \left[ \left( (n-1) - \frac{N}{2} \right) + 0.5 \right] B \quad (4)$$

Theoretically, the bandwidth and pulse width are improved  $N$  times, where  $N$  is the number of transmitted intra-pulses. This infers that the range resolution of a SAR system that employs SF<sub>c</sub>-LFM scheme signal shall be improved  $N$  times. In summary, the effective bandwidth  $B_{eff}$ , the effective pulse width  $T_{eff}$ , and the effective range resolution  $\Delta R_{eff}$  are now,

$$B_{eff} = N \times B \quad (5)$$

$$T_{eff} = N \times T_p \quad (6)$$

$$\Delta R_{eff} = \frac{c}{2B_{eff}} \quad (7)$$

Figure 2 depicts the overall up-conversion process of the baseband intra-pulses into its respective adjacent carrier frequency that results in widening its effective bandwidth and pulse width. The intra-pulses in the carrier band are transmitted as in a conventional SAR system. The collected echo is then mixed with its own respective carrier signal to down-convert them into baseband for digitizing and recording. At each intra-pulse interval,  $t_{pri\_int}$ , a trigger signal is sent to the SAR processor to initiate the recording of the echo pulse. As a result, the SF<sub>c</sub>-LFM SAR system records  $N$  times more echo pulses as compared to a conventional SAR system. It shall be noted that due to the triggering nature in the data acquisition system, the initial point for each collection of digitized echo intra-pulses is zero time referenced.

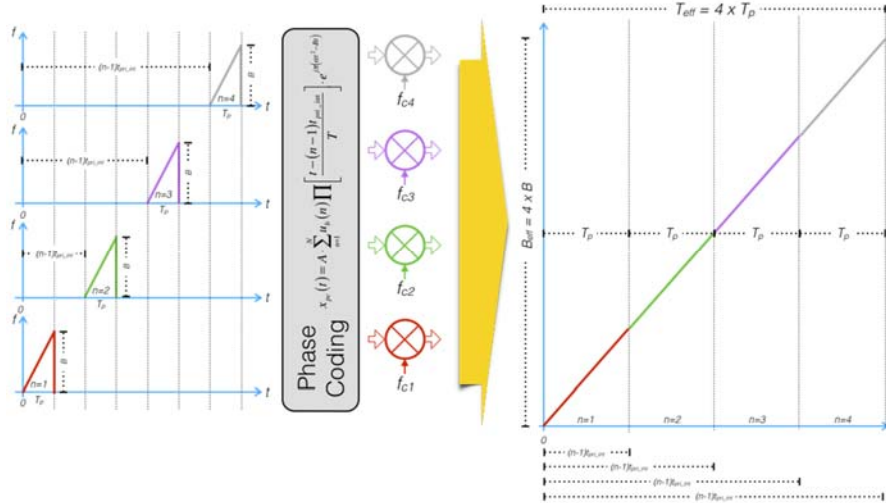

Figure 2: Proposed Phase Coded SF<sub>c</sub>-LFM Technique

The collected intra-pulses are stored as an array of digital data with  $N$  intra-pulses. Before it can be used for SAR image formation, it requires an additional process that employs a dedicated signal re-construction algorithm to merge the recorded data into its equivalent pulse. Theoretically, the re-constructed equivalent pulse shall be,

$$x_{equi}(t) = A \cdot \Pi\left(\frac{t}{T_{eff}}\right) \cdot e^{j\pi(\alpha_{eff}t^2 - B_{eff}t)} \quad (8)$$

where,

$B_{eff}$  = Effective bandwidth

$T_{eff}$  = Effective pulse width

$\alpha_{eff}$  = Effective LFM rate =  $B_{eff} \times T_{eff}$

Figure 3 shows the signal re-construction process with a record of 4 intra-pulses ( $N = 4$ ). The received echo for each of the intra-pulses can be formulated as,

$$x_n(t_n) = A_n \cdot u_b(n) \cdot \Pi\left(\frac{t_n}{T}\right) \cdot e^{j\pi(\alpha t_n^2 - B t_n)} \cdot e^{j2\pi f_c t_n} \quad (9)$$

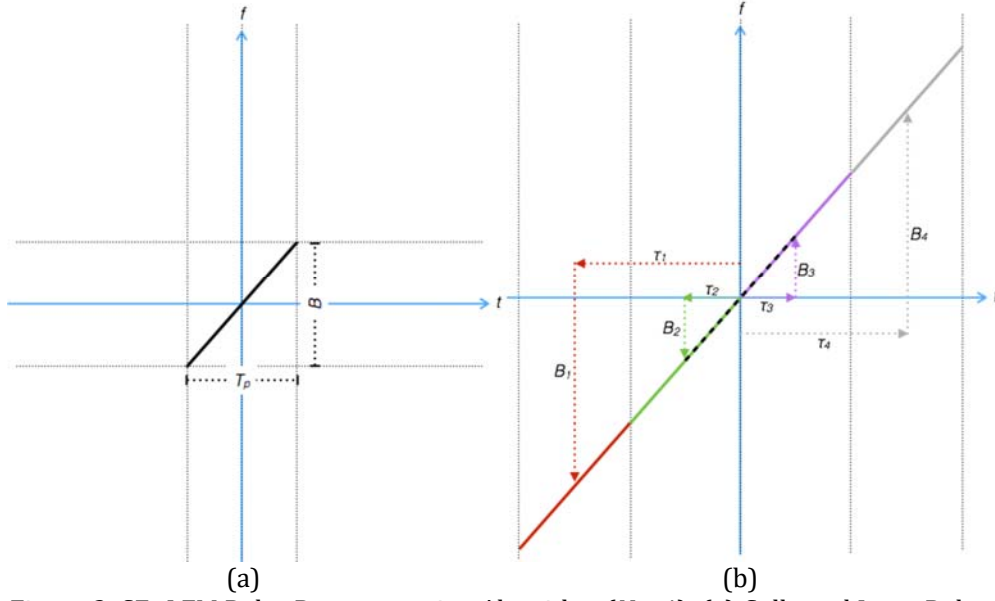

Figure 3: SF<sub>c</sub>-LFM Pulse Reconstruction Algorithm ( $N = 4$ ): (a) Collected Intra-Pulses Echoes, (b) Signal Reconstruction Algorithm

All of the collected echo intra-pulses will reside at the origin of the time-frequency plot, as shown in the left diagram of Figure 3. In the signal re-construction process, the echo pulses will be re-arranged into their respective frequency bands and time slots. Mathematically, this is by adding a time shift of,  $\tau_n$ , and a frequency shift of,  $B_n$  into each echo intra-pulse. Then, Equation (9) becomes,

$$x_n(t_n - \tau_n) = A_n \cdot u_b(n) \cdot \Pi\left(\frac{t_n - \tau_n}{T}\right) \cdot e^{j\pi(\alpha(t_n - \tau_n)^2 - B(t_n - \tau_n))} \cdot e^{j2\pi f_c(t_n - \tau_n)} \cdot e^{j2\pi B_n(t_n - \tau_n)} \quad (10)$$

where,

$$\tau_n = \left[ \left( (n-1) - \frac{N}{2} \right) + 0.5 \right] T \quad (11)$$

$$B_n = \left[ \left( (n-1) - \frac{N}{2} \right) + 0.5 \right] B \quad (12)$$

Solving Equation (10), then, down-converting them to baseband, and finally, removing the additional phase added during the waveform generation, this finally gives,

$$x_n(t_n - \tau_n) = A \cdot \Pi\left(\frac{t_n - \tau_n}{T}\right) \cdot e^{j\pi(\alpha t_n^2 - 2\alpha t_n \tau_n - B t_n + 2B_n t_n + \alpha \tau_n^2 + B \tau_n - 2f_c \tau_n - 2B_n \tau_n)} \quad (13)$$

From Equation (13), it is shown that the phase for each collected intra-pulse echo should be shifted with a time shift,  $\tau_n$ , and a phase shift with  $\Phi_n$ , where  $\Phi_n$  can be quantified as,

$$\Phi_n = j\pi(-2\alpha t_n \tau_n + 2B_n t_n + \alpha \tau_n^2 + B \tau_n - 2f_c \tau_n - 2B_n \tau_n) \quad (14)$$

### 3. FPGA-based Baseband Waveform Synthesizer

An FPGA-based baseband waveform synthesizer was built (Chua and Koo, 2009). In the hardware, it uses Altera Cyclone IV chips as its programmable core with on-board dual-channel, 14-bits, 420 MSPS DAC. Figure 4 shows the custom made FPGA waveform synthesizer board and Table 1 lists the main features of the board. In order to generate the required baseband LFM signals for up-conversion, the board is configured with a real-time re-configurable radar waveform synthesizer as shown in work by Chua *et. al.* (Chua *et. al.*, 2012). Figure 5 depicts the block diagram of the implemented synthesizer.

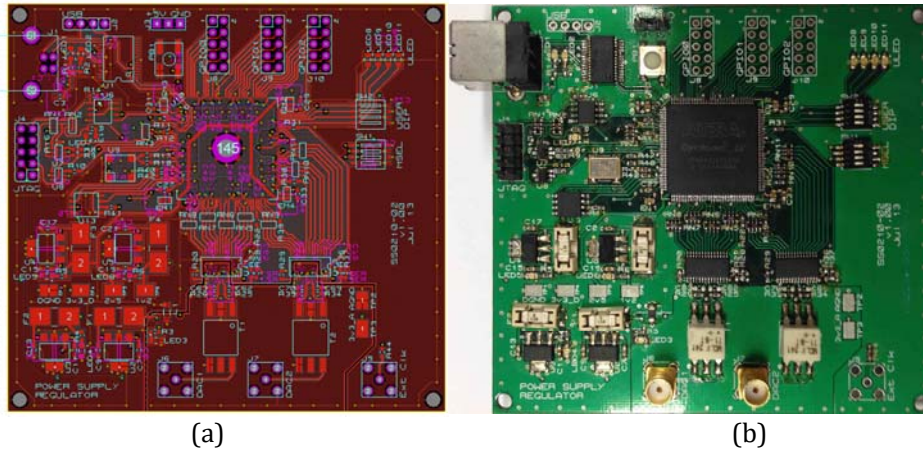

Figure 4: SF<sub>c</sub>-LFM Pulse Reconstruction Algorithm ( $N = 4$ ): (a) Collected Intra-Pulses Echoes, (b) Signal Reconstruction Algorithm

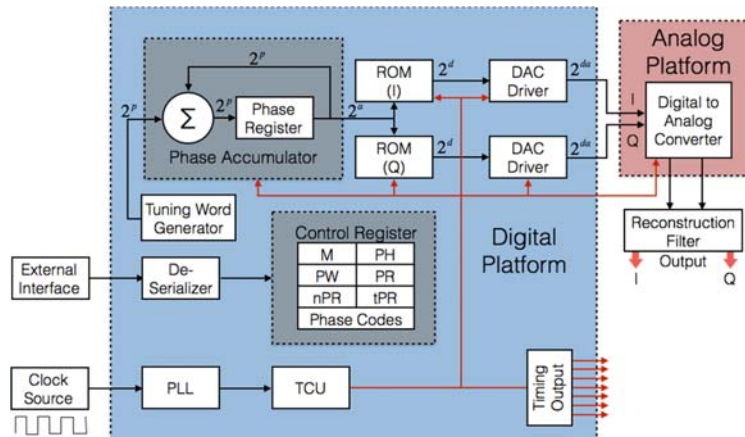

Figure 5: Block Diagram of the Phase Coded SF<sub>c</sub>-LFM Waveform Synthesizer

Table 1: Main Features of Custom Designed Altera Cyclone FPGA Board

Module	Specifications
FPGA	<ul style="list-style-type: none"> <li>- Altera EP4CE22E22C7N</li> <li>- 22,320 LEs</li> <li>- 594 Kbits total memory</li> <li>- 66 18x18-bit multipliers</li> <li>- 4 General Purpose PLLs</li> <li>- 153 user I/Os</li> </ul>
DAC	<ul style="list-style-type: none"> <li>- Analog Device AD9744 DAC</li> <li>- 2 Channel 210 MSPS</li> <li>- 14-bits resolution</li> </ul>



#### 4. Experimental Setup

An in-lab proof-of-concept experimental setup was constructed to verify the waveform synthesis technique. Figure 6 illustrates the simplified block diagram of the entire setup.

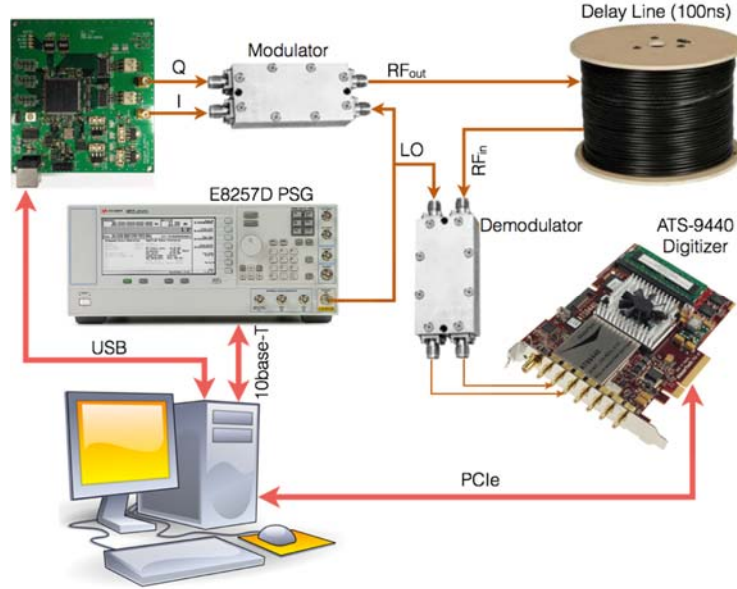

Figure 6: An Illustration of Proof-of-Concept Experimental Setup

In the transmitter, the baseband intra-pulses are up-converted to its respective carrier using an off-the-shelf microwave quadrature modulator. An RF signal generator generates the required stepped carrier signal for the up-conversion. In order to ensure coherency in the transmitted intra-pulses, the selected signal generator has low phase noise ( $< -120\text{dBc/Hz}$  @ 20 kHz offset) to minimize the phase difference between the intra-pulses. The up-converted intra-pulses are fed into a calibrated microwave delay line for single point target echo emulation. The intra-pulse echoes were then down-converted using an off-the-shelf microwave demodulator and finally these echoes were recorded using an embedded controller with high-speed digitizer.

Table 2: SF<sub>c</sub>-LFM Waveform Parameters

Parameters	Value
Number of intra-pulses, $N$	8
Intra-pulses bandwidth, $BW$	50 MHz
Pulse Repetition Frequency, $PRF$	1 kHz
Pulse Width, $T_p$	10 $\mu\text{s}$
Carrier Frequency, $f_c$	2000 MHz
– 1 <sup>st</sup> carrier frequency, $f_1$	1825 MHz
– 2 <sup>nd</sup> carrier frequency, $f_2$	1875 MHz
– 3 <sup>rd</sup> carrier frequency, $f_3$	1925 MHz
– 4 <sup>th</sup> carrier frequency, $f_4$	1975 MHz
– 5 <sup>th</sup> carrier frequency, $f_5$	2025 MHz
– 6 <sup>th</sup> carrier frequency, $f_6$	2075 MHz
– 7 <sup>th</sup> carrier frequency, $f_7$	2125 MHz
– 8 <sup>th</sup> carrier frequency, $f_8$	2175 MHz
Effective Bandwidth, $B_{eff}$	400 MHz
Effective Pulse Width, $T_{eff}$	10 $\mu\text{s}$

Table 2 summarizes the SF<sub>c</sub>-LFM signal parameters ( $N = 8$ ). The intra pulses are up-converted to different carrier frequency,  $f_1 - f_8$ , as depicted in Equation (4). Based on Equation (5) and Equation (6), for the generated SF<sub>c</sub>-LFM signal, the effective bandwidth,  $B_{eff}$ , is 400 MHz, and the effective pulse width,  $T_{eff}$ , is 80  $\mu$ s.

## 5. Results and Findings

The spectrum of SF<sub>c</sub>-LFM waveform in carrier band are recorded using a spectrum analyzer. Figure 7 shows the recorded frequency spectrum of each of the transmitted intra-pulses and the DSP combined spectrum of the resultant signal.

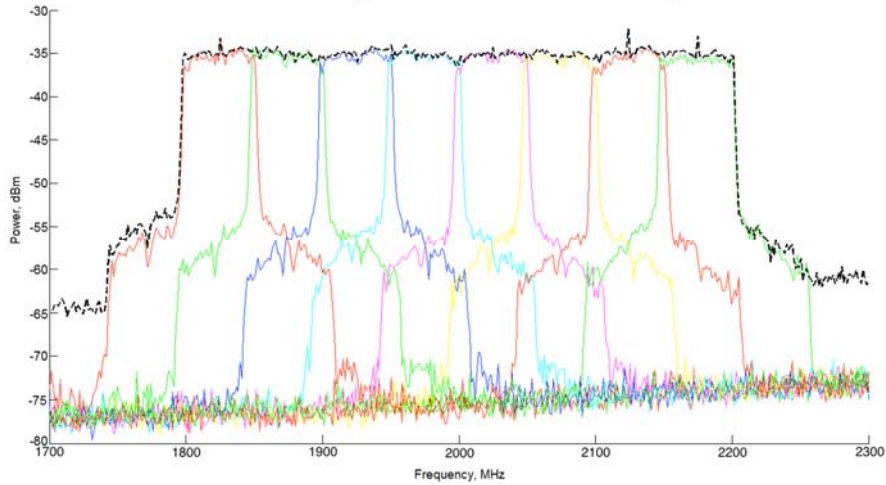

Figure 7: Frequency Spectrum of SF<sub>c</sub>-LFM ( $N = 8, B = 50$  MHz): DSP Combined Spectrum (Black colour), Individual Intra-Pulse Spectrum (Other colours)

A phase decoding process (or intra-pulses decryption) is required to remove the phase code added during the baseband waveform generation. Figure 8 illustrates that, without the phase decoding process, the re-constructed pulses will not be able to compress into its equivalent impulse response.

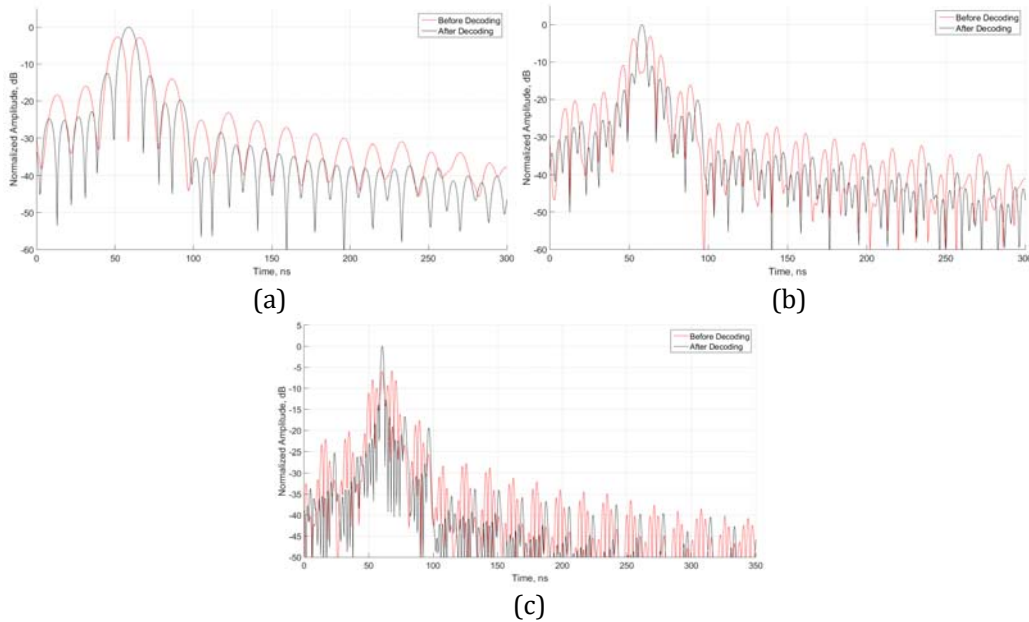

Figure 8: Match Filter Output of SF<sub>c</sub>-LFM Received Signal; (a)  $N = 2$ , (b)  $N = 4$ , (c)  $N = 8$ .

Figure 9 – Figure 14 show the recorded intra-pulses, the re-constructed pulse and the Auto-Correlation Function (ACF) a.k.a match filter output of the reconstructed pulse. Meanwhile, the measured Peak Side-Lobe Ratio (PSLR) and the Impulse Response Width (IRW) improvement factor obtained for SF<sub>c</sub>-LFM waveforms are tabulated in Table 3.

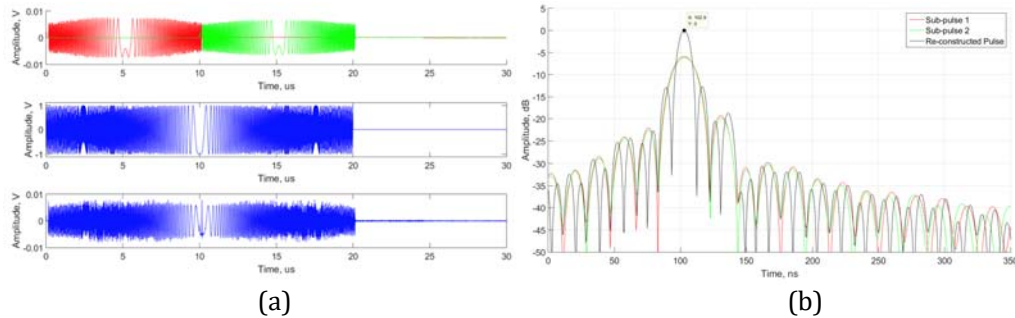

Figure 9: SF<sub>c</sub>-LFM for  $N = 2$ ,  $t_d = 100$ ns; (a) Top – Intra-Pulses, Middle – Reference Signal, Bottom – Reconstructed Pulse; (b) ACF of the Reconstructed Pulse

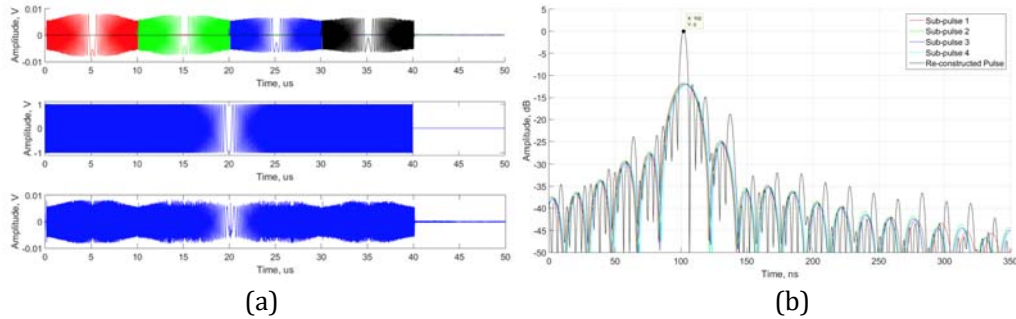

Figure 10: SF<sub>c</sub>-LFM for  $N = 4$ ,  $t_d = 100$ ns; (a) Top – Intra-Pulses, Middle – Reference Signal, Bottom – Reconstructed Pulse; (b) ACF of the Reconstructed Pulse

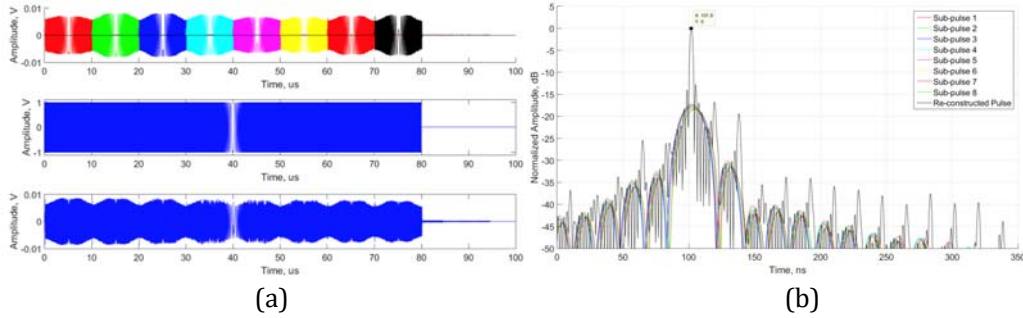

Figure 11: SF<sub>c</sub>-LFM for  $N = 8$ ,  $t_d = 100$ ns; (a) Top – Intra-Pulses, Middle – Reference Signal, Bottom – Reconstructed Pulse; (b) ACF of the Reconstructed Pulse

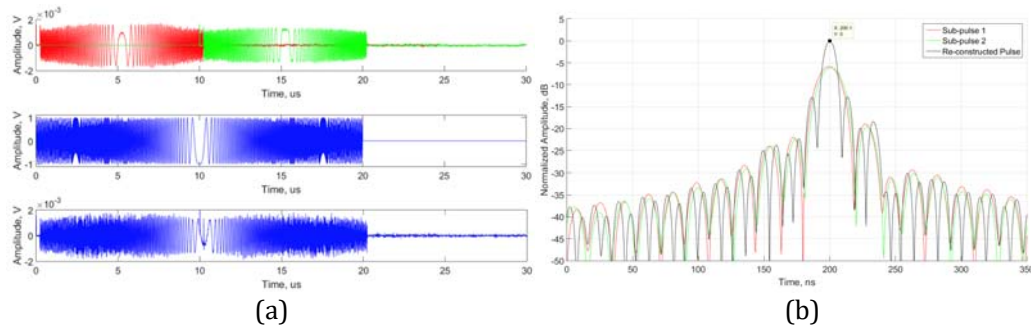

Figure 12: SF<sub>c</sub>-LFM for  $N = 2$ ,  $t_d = 200$ ns; (a) Top – Intra-Pulses, Middle – Reference Signal, Bottom – Reconstructed Pulse; (b) ACF of the Reconstructed Pulse

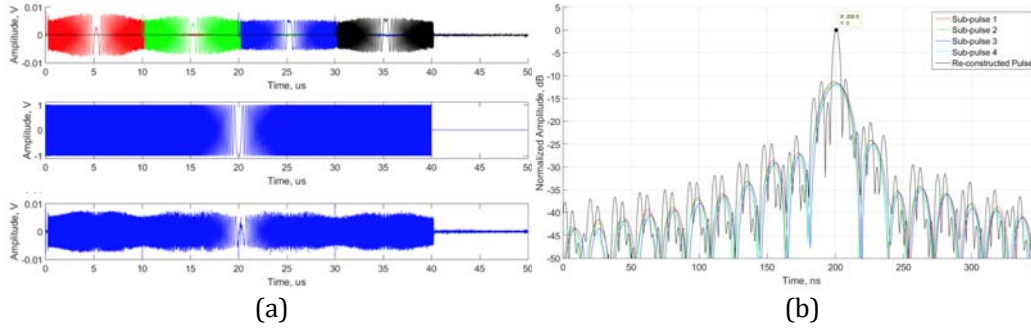

Figure 13: SF<sub>c</sub>-LFM for  $N = 4$ ,  $t_d = 200\text{ns}$ ; (a) Top - Intra-Pulses, Middle - Reference Signal, Bottom - Reconstructed Pulse; (b) ACF of the Reconstructed Pulse

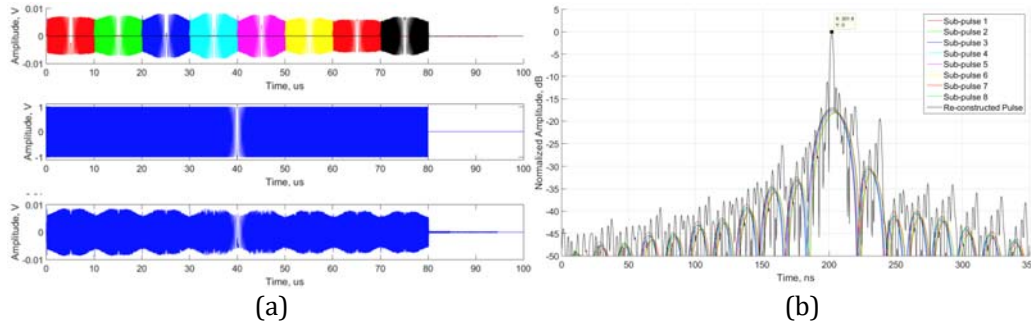

Figure 14: SF<sub>c</sub>-LFM for  $N = 8$ ,  $t_d = 200\text{ns}$ ; (a) Top - Intra-Pulses, Middle - Reference Signal, Bottom - Reconstructed Pulse; (b) ACF of the Reconstructed Pulse

Table 3: Peak Side-Lobe Ratio Comparison (PSLR) and Improvement in Impulse Response Width (IRW) using SF<sub>c</sub>-LFM

Number of intra-pulses $N$	Delay (ns)	PSLR (dB)		IRW (ns)		Improvement Factor in IRW (Unit less)	
		Single-Pulse LFM	SF <sub>c</sub> -LFM	Single-Pulse LFM	SF <sub>c</sub> -LFM	Estimated	Measured
2	100	-13.36	-12.89	17.23	8.32	2.00	2.07
	200	-13.11	-12.92	17.23	8.33	2.00	2.07
4	100	-12.96	-12.02	16.70	4.03	4.00	4.14
	200	-12.85	-10.73	16.70	4.01	4.00	4.16
8	100	-12.92	-12.70	16.70	2.00	8.00	8.35
	200	-12.90	-11.25	16.70	1.98	8.00	8.43

## 6. Conclusion

This paper presents a SF<sub>c</sub>-LFM technique to generate UWB SAR LFM signal. The technique can synthesize a greater bandwidth and wider pulse width signal as compared to conventional SAR system. The obtained result has proven that SF<sub>c</sub>-LFM technique is able to improve the system range resolution, whilst maintain the required SAR signal quality. Also, the introduction of phase coding scheme into the transmitting signal enhanced the immunity of the radar system on radar system's electronics countermeasure. In conclusion, the proposed waveform modulation technique and its synthesis technique can practically be implemented.

## Acknowledgements

This work is funded by the Minister of Higher Education Malaysia (MOHE) under account no 203.PJJAUH.6711279, and Japanese International Cooperation Agency (JICA).

## References

- Barton D. K. (1988), *Modern Radar System Analysis*, Norwood, Artech House.
- Chan Y. K., Koo V. C. (2008), An Introduction to Synthetic Aperture Radar (SAR), *Progress in Electromagnetics Research B*, Vol. 2, pp. 27-60.
- Chan Y. K., Lim S. Y. (2008), Synthetic Aperture Radar (SAR) Signal Generation, *Progress in Electromagnetics Research B*, Vol. 1, pp., 269-290.
- Chua M. Y., Koo V. C. (2009), "FPGA-based Chirp Generator for High Resolution UAV SAR", *PIER99*, pp 71-88.
- Chua M.Y., Boey H.S., Lim C.H., Koo V.C., Lim H.S., Chan Y.K., Lim T. S. (2012), "A Miniature Real-Time Re-configurable Radar Waveform Synthesizer for UAV based Radar", *PIERC2012*, Vol. 31, pp. 169-183, 2012.
- Mahafza B. F. (1998), *Introduction to Radar Analysis*, New York, CRC Press.
- Skolnik M. I. (1970), *Radar Handbook*, New York, McGraw-Hill.
- Ulaby F. T., Moore R. K., and Fung A. K. (1981), *Microwave Remote Sensing: Active and Passive*, Vol. 1, Norwood, Artech House.

**Topic :** Computer and Information Technology

## **NETWORK BASED DATA ACQUISITION AND CONTROL SYSTEM FOR CIRCULAR POLARISATION SAR (CP-SAR) SENSOR ON UAV**

Agus Hendra Wahyudi, Josaphat Tetuko S. Sumantyo, Heein Yang, Matsumura  
Kohei, Yuta Izumi.

*Josaphat Microwave Remote Sensing Laboratory, Center for Environmental Remote  
Sensing, Graduate School of Advance Integration Science, Chiba University, 1-33, Yayoi,  
Inage, Chiba, 263-8522, Japan*

---

### **Abstract**

High resolution C band CP-SAR sensor has been developing for natural disaster and earth monitoring using UAV platform in JMRS. This paper will describe one method of data acquisition system using fast Ethernet interface for continuous operation during UAV's flight. Graphical user interface was made using visual c# to allow operator to control and monitor SAR system and operation. Hardware in the loop for low altitude flight operation has been done and discussed for ensuring system working well before real flight test. Transfer rate less than 10% of PRI can be achieved in this low altitude operation particularly 150 meter, cruise speed 100 km/h and 1000 PRF chosen value. That result show the gigabit network based data acquisition provide good transfer rate for continuous CP-SAR sensor data logging and allow the user to change SAR sensor operation and parameter remotely.

### **Keywords**

*Keywords:* UAV, network, data acquisition, CP-SAR

---

### **1. INTRODUCTION**

Earth surface monitoring by UAV has been increased in recent years. It can give local area data information for fast response such as on natural disaster monitoring and decision support system on disaster area (Li et al. 2011, Fikar et al. 2016). Optical sensor was common passive sensor utilized on UAV. However, it can not operate on night and bad weather. On the other hand SAR sensor was active sensor that can give data day night and all weather therefore many platform use this technique for earth observation such as ground based, spacecraft, airborne and UAV (Bayuaji et al. 2010).

Conventional SAR sensor utilized linear polarisation while a novel method will be performed in this research is circular polarization SAR sensor. The benefit of using circular polarization is polarization loss factor robustness due to mismatch polarization

usually in LP case when some disturbance in UAV flight path happened. Thus, better detection of target will be more reliable. In addition, CP SAR sensor on spacecraft will be more robust than LP-SAR due to faraday rotation that will make polarization mismatch increase in LP(freeman and S.Saachi, 2004).

One of SAR image quality is represented by resolution number, which is dependent on the bandwidth of signal called chirp. In order to get sub-meter high range resolution on C Band SAR image we implemented 400 MHz chirp bandwidth. Backscattered signal from earth surface will be sampled with high sampling ADC and saved to hard disc computer for image processing, therefore this system requires fast transfer data rate such as network gigabit Ethernet interface. Network based data acquisition and control allow UAV CP SAR researcher to control gain of RF system and configure PRF, bandwidth of chirp signal and store data continuously during SAR flight UAV operation. The system will be described in this paper and hardware in the loop experimental set up will be presented for ensuring functional system work well before flight test.

## 2. SAR DATA ACQUISITION SYSTEM

SAR data acquisition system is a method to collect a SAR raw data. It contains RF system, Antenna sensor, embedded system and graphical user interface in laptop/pc for control SAR parameter and display data.

### 2.1 Block Diagram of SAR System

Block diagram C band CP-SAR system can be shown in figure 1.

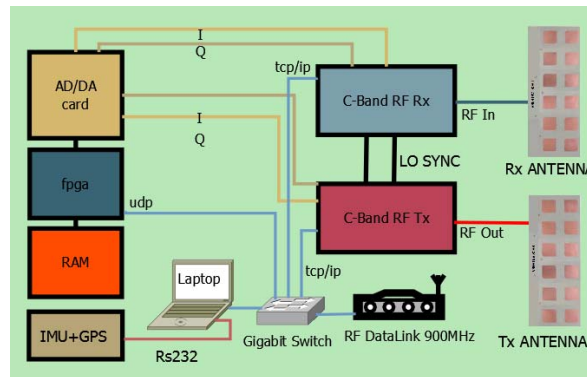

Figure 1. Block Diagram C Band SAR System

Embedded system will produce chirp signal 200 MHz. AD/DA from analog devices connected to FPGA through High speed FMC card provide high sampling 2.6 GSPS for DAC and 1GSPS for ADC. FPGA system board KC105 has 2 GB DDR4 Ram for FIFO buffer I and Q data from ADC. It also has gigabit ethernet port communication to transfer data to hard disk PC/Laptop for further analysis.

RF system transmitter and receiver have TCP/IP communication port for configuration such as SSPA gain control transmitter, gain offset and phase shifter. The transmitter contains baseband unit to combine signal from DAC in-phase and quadrature with IF local oscillator, upconverter unit to convert IF signal to C band RF 5.3 GHz, and SSPA unit for amplify the signal and pass them through antenna. RF system receiver contains LNA and Down-converter to provide baseband In-phase and Quadrature signal for ADC analog input.

The received signal will be sampled by ADC card daughter board of fpga system, saved in buffer RAM and transferred to laptop through gigabit ethernet UDP communication. Motion sensor IMU and GPS simultaneously send data to laptop through serial interface for geolocation metadata of CP-SAR raw data. All process of data acquisition and baseband controller can be monitored and controlled by operator through RF datalink 900 MHz communication.

## 2.2 CP Antenna Sensor

Antenna should have good axial ratio < 3dB for circular polarisation. Circular polarization antenna will operate on Left Handed Circular polarization and Right handed circular polarization (RHCP and LHCP) which one antenna will be used for transmitter and another for receiver.

## 2.3 Stripmap Geometri and Resolution

Side-looking synthetic aperture radar (Stripmap mode SAR) will be utilized for generate image of earth with high resolution.

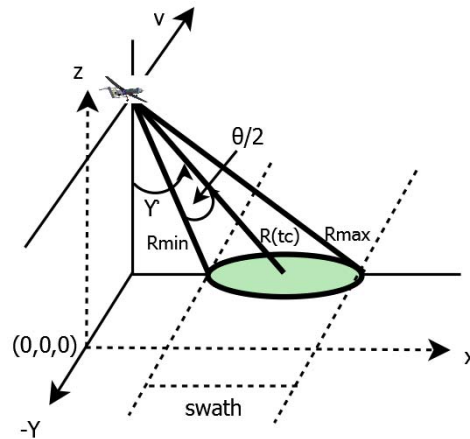

Figure 2. SAR Stripmap Geometry

Figure 2. describe geometry parameter such as swath width, minimum range, maximum range that can be stated as :

$$R_{\min} = \frac{H}{\cos(\gamma - \theta/2)}$$

$$R_{\max} = \frac{H}{\cos(\gamma + \theta/2)}$$

$$Sw = \sqrt{R_{\max}^2 - H^2} - \sqrt{R_{\min}^2 - H^2}$$

Where  $\gamma$  is look angle of antenna,  $\theta$  is 3dB beam-width of antenna in elevation and  $H$  is UAV or platform altitude. Preeminence of SAR image is important that can be expressed by resolution. Range resolution rely upon baseband signal bandwidth of chirp as can be presented :



$$\nabla R = \frac{c}{2B}$$

Bandwidth chirp signal entering RF system limited to 200 MHzs quadrature therefore submeter resolution can be achieved. Chirp signal can be stated as equation below :

$$y = r \left\{ \frac{t}{T} \right\} e^{\pi \frac{B}{T} t^2}$$

Where B is bandwidth of chirp signal, T is pulsewidth and r is pulse amplitude modulation signal.

Azimuth resolution depend on SAR antenna length, as can be stated :

$$\nabla z = \frac{L}{2}$$

Where L is physical antenna length in azimuth direction.

#### **.2.4 Sample Window Time and PRF**

Sampling data of SAR will be divided to be two dimension in range and azimuth, which fast time in range and slow time in azimuth direction. Fast time sample should be fast enough to detect chirp signal, as nyquist criteria it has to be minimum twice of chirp bandwidth. Sampling window time in one range will be depend on the maximum range and pulse width of chirp signal as can be stated:

$$t_{rw} = \frac{2R_{max}}{c} + T$$

While in azimuth direction, window sample timing depend on the speed of UAV and antenna 3dB azimuth beamwidth as can be stated below:

$$t_{az} = \frac{R_{max} \theta_{az}}{v}$$

PRF selection should be considered in order to collect unambiguous range and doppler frequency which is represent by minimum and maximum chosen value criteria (Mahafza,2004).

$$\frac{c}{2(R_{max} - R_{min})} \geq PRF \geq \frac{2v}{\lambda} \theta \sin \gamma$$

#### **2.5 Graphical User Interface**

Graphical user interface was made to provide changing signal parameter, SAR mode operation and time duration to be implemented on SAR data acquisition system. Visual c# will be used to realize this GUI, the flowchart can be shown in figure 3 and 4.

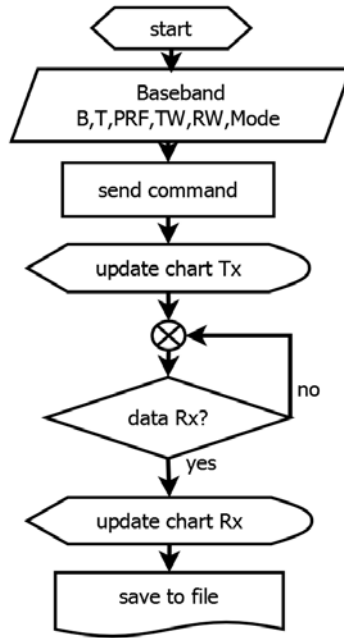

Figure 3. GUI Single Mode FlowChart

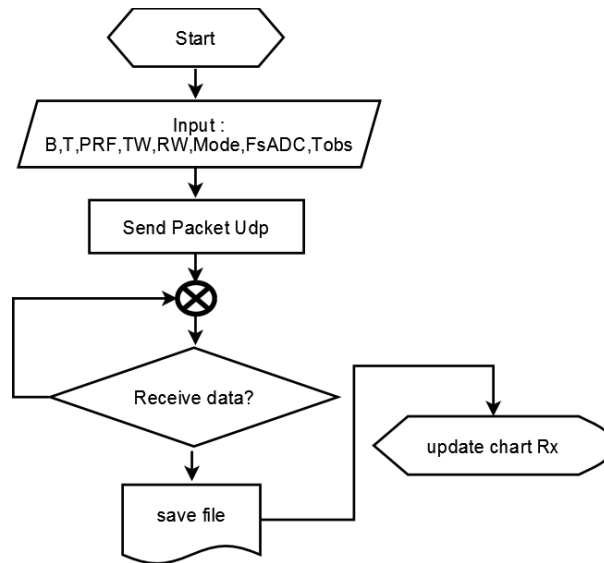

Figure 4. GUI Observation Mode Flowchart

From figure 3 and 4 operator can change some parameter of SAR mode, bandwidth, pulsewidth, timing window, and ADC sampling frequency. Specific command will be sent to FPGA through UDP communication. After receiving data, in single mode they will be displayed on chart directly while in observation mode they will be saved to file before some sample data displayed to chart.

### 3. Experiment

Experiment data acquisition CP-SAR was tested using hardware in the loop method which is described condition operation before real flight test.

#### 3.1 Experimental Setup

In this hardware in the loop experiment we use JX2 platform as referenced, which antenna dimension 0.75 m length and 0.2 m width. The off nadir angle of antenna adjust to 37.5 degree. JX 2 fly on low altitude 150 meter to obey UAV flight limitation rule in Indonesia (jonan,2015) with cruise speed 100 km/h.

#### 3.2 Experimental Result

This experiment setup condition lead 16.2 degree for Range direction 3dB beamwidth and 4.324 degree azimuth direction 3dB beamwidth such as shown in figure 6.

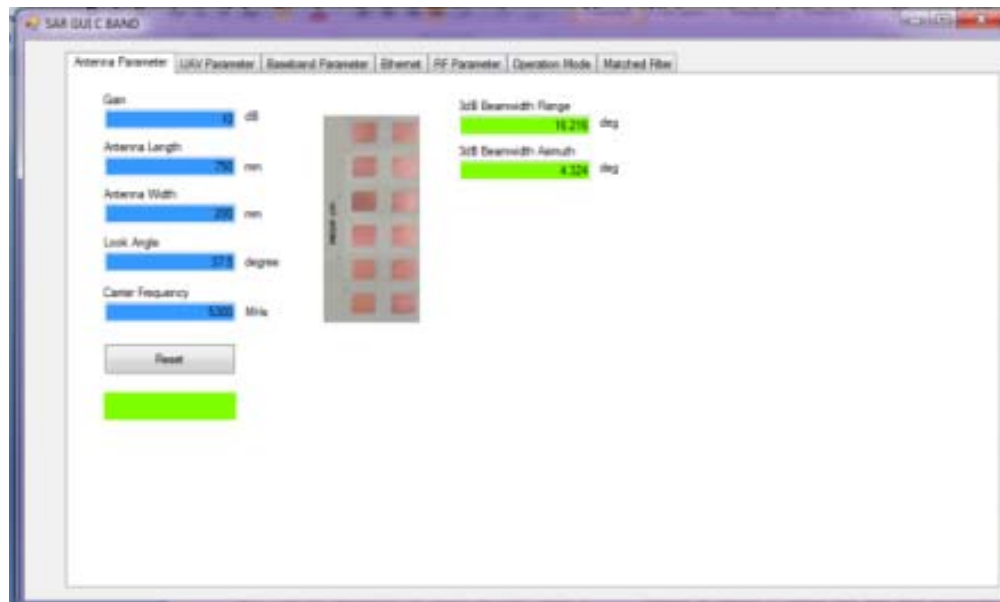

Figure 6. Antenna 3dB Beamwidth

Combine with UAV flight condition and antenna on stripmap mode SAR provide timing result information on figure 7.

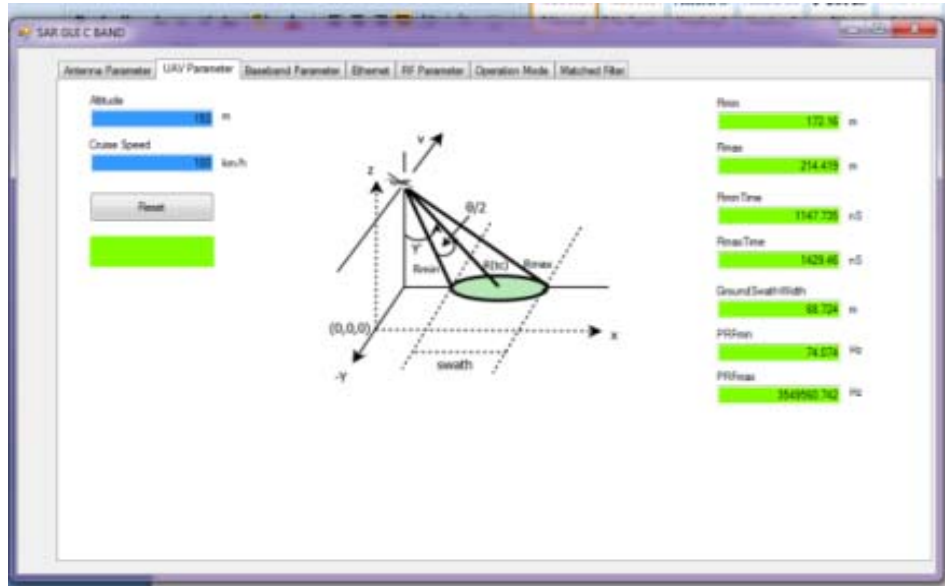

Figure 7. Stripmap Geometry SAR result

Baseband signal reference to be transmitted is shown in figure 8 which has 200 MHz bandwidth bilinear chirp signal inphase and quadrature.

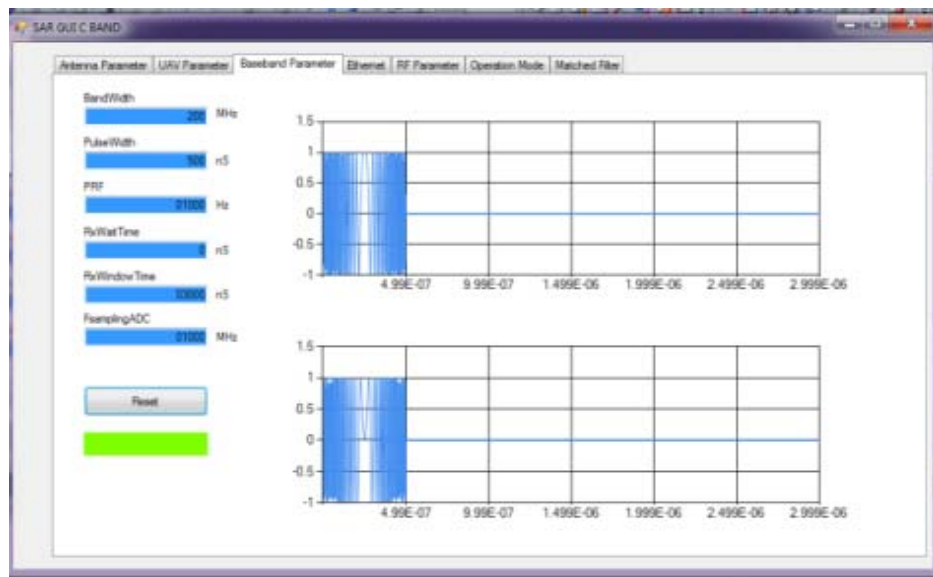

Figure 8. Signal Transmitted Reference

The backscattered signal raw data from fpga/PC through gigabit ethernet can be shown in figure 9. It is delayed form of Tx signal due to target distance from UAV and added random noise function.

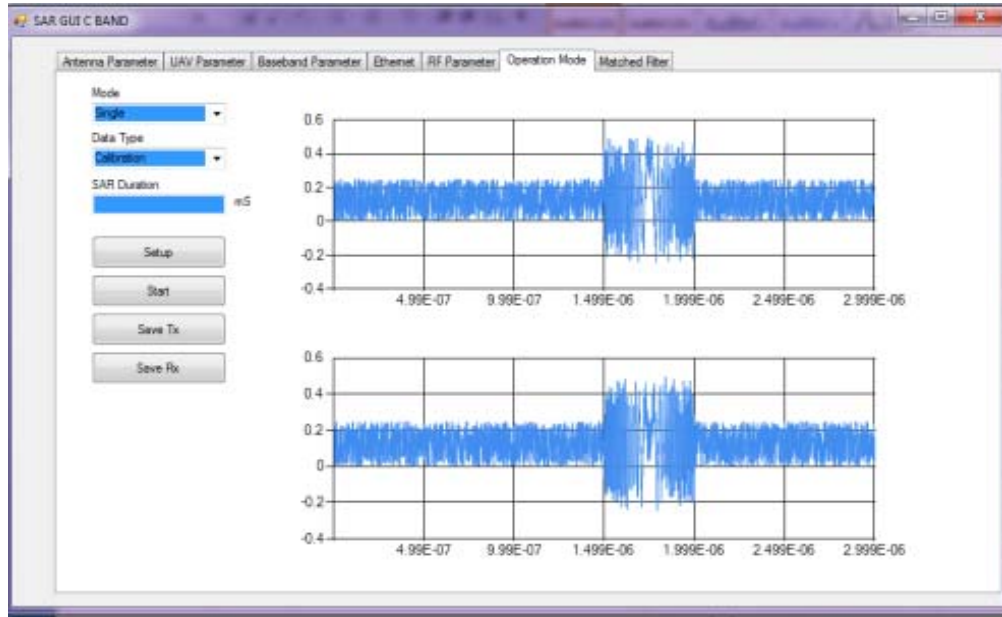

Figure 9. Signal Transmitted Reference

The matched filter signal is convolution signal reference and signal received as can be shown in figure 10.

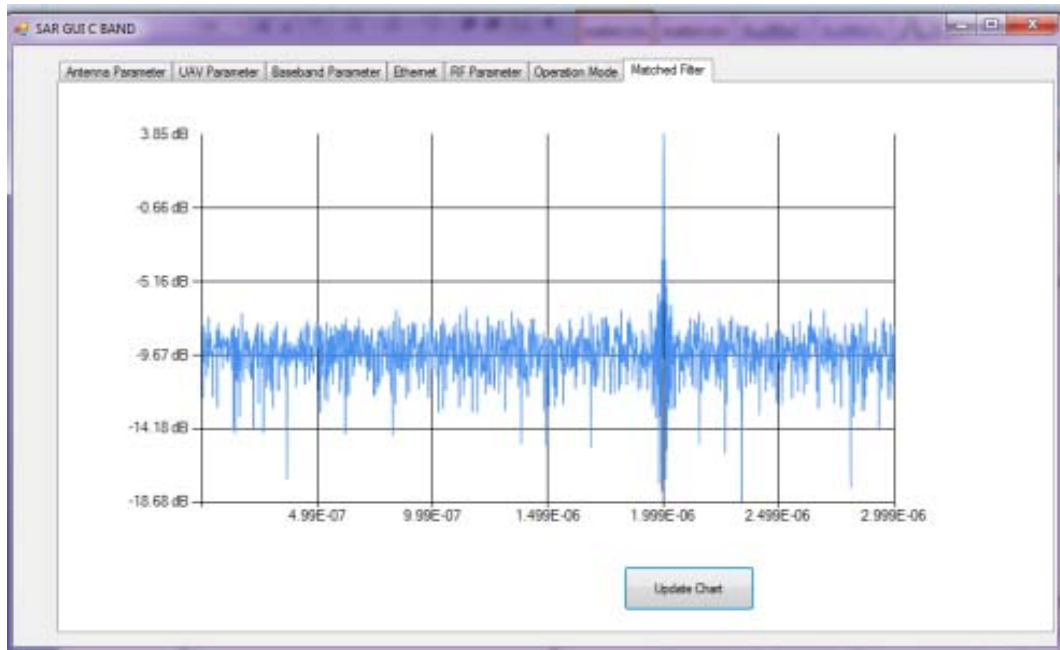

Figure 10. Matched Filter Result

It is clear that target can be detected using matched filter.

#### 4. Result Analysis

Antenna as SAR sensor mount on JX-2 has length dimension = 0.75 meter and antenna width dimension 0.2 meter. These parameter will lead 3dB beamwidth in azimuth and

range as  $16.2^\circ$  and  $4.34^\circ$  respectively. In order to reach  $30^\circ$  to  $46^\circ$  incident angle of image the look angle of antenna should be adjust to  $37.5^\circ$  inside JX2 fuselag.

UAV JX2 will fly at 150 meter low altitude, with 1000 Hs Pulse repetition frequency (PRF). The PRF value is higher than PRF minimum limitation (74Hs) due to cruise speed of JX2 at 100 km/h antenna length 0.75 meters. In addition chirp signal has very high bandwidth 200 MHs in order to get sub meter range resolution.

This Single polarisation system C Band SAR will provide in-phase and quadrature signal with 16 bit resolution ADC and 1 Gbps. At this low altitude SAR geometry the receiving window time will be very short only  $3 \mu\text{s}$ . Raw data collected each pulse will be 96000 bit, then they will be delivered to laptop hardisk by gigabit ethernet UDP in order to be saved to hardisk. The transfer time of raw data to laptop only  $96 \mu\text{s}$  or 9.6% from PRI, which is very enough transfer time in one pulse. This low altitude SAR operation will be collected data for 10 seconds continuously for 280 meter flight distance, with 1000 PRF it will collect 120Mbytes which is enough space for external RAM of FPGA to buffer all measurement data.

## 5. Conclusion

Network based data acquisition of C band CP-SAR sensor on UAV was described. Hardware in the loop test also was done for low altitude UAV operation for ensure that the system working well. From the result and discussion it is ready for test using real embedded system in near future for natural disaster monitoring.

## Acknowledge

Thank you for reseach support from Riset-Pro Ristek-Dikti Indonesia and collaboration research team in JMRS� Ceres Chiba University for this research project.

## References

- Bayuaji et al. (2010). ALOS PALSAR D-InSAR for Land Subsidence Mapping in Jakarta, Indonesia. Canadian Journal of Remote Sensing. Vol. 36, No. 1, pp. 1-8.
- Fikar et al. (2016). A Decision Support System for Coordinated Disaster Relief Distribution. Expert System With Application 57 104-116.
- Freeman and S. Saatchi. (2004). On The Detection of Faraday Rotation in Linearly Polarized L-Band SAR Backscatter Signature. IEEE Transactions On Geoscience And Remote Sensing, Vol. 42. No. 8.
- Jonan. (2015). Pengendalian Pengoperasian Pesawat Tanpa Awak di Ruang Udara Yang Dilayani Indonesia. Peraturan Menteri Perhubungan Republik Indonesia. Nomor PM 90. Jakarta, Indonesia.
- Li et al. (2011). Quick Image Processing Method of UAV Without Control Point Data in Earthquake Disaster Area. Transaction of Nonferrous Metals Society Of China. S523-S528. Elsevier Science Press. China.
- Mahafza (2004). Matlab Simulations for Radar System Design. CRC Press. USA.

**Topic :** Computer Science

## **CP-SAR Image Processing System with Kintex-7 FPGA Board**

Masaru Bunya<sup>a</sup>, Kazuteru Namba<sup>a</sup>, Josaphat Tetuko Sri Sumantyo<sup>b</sup>

<sup>a</sup>Graduate School of Advanced Integration Science, Chiba University, Chiba, Japan

<sup>b</sup>Center for Environmental Remote Sensing, Chiba University, Chiba, Japan

---

### **Abstract**

Synthetic Aperture Radar (SAR) is a class of multipurpose sensors, which can operate in all-weather and day-night time. In Chiba University, We have a plan a verification experiment for Circularly Polarized SAR (CP-SAR) using Unmanned Aerial Vehicle (UAV). Since CP wave is not affected by an ionosphere, it's expected to allow for more precise observation. Raw image data received by CP-SAR needs to be applied image processing, but it will not be processed on the ground. Considering the communication time, only the image processed on UAV is sent.

Our previous image processing system needs high power consumption and takes up space because it uses Vertex-6 FPGA Board ML605, Spartan-6 FPGA Board SP605 and one PC which has Intel Atom processor and a Solid State Drive (SSD). In this system, Range Doppler Algorithm (RDA) which is major image processing algorithm for SAR is executed in ML605 and the others is used to save the image to SSD. Our proposed system only uses Kintex-7 FPGA Board KC-705 with XM104 Connectivity Card. XM104 makes it possible for KC-705 to use SATA; it can connect SSD without a PC. It's expected to reduce power consumption, space, time of development and modification.

Our CP-SAR image processing system is required semi-real-time observation. KC705 has high performance than ML605 so we expect it to satisfy this requirement and to reduce image processing time. The proposed system is applicable to SAR image processing system on an UAV making semi-real-time observation.

### **Keywords**

*Keywords: CP-SAR, SAR image processing, on-board processing, FPGA, Kintex-7*

---

## **1. Introduction**

To observe global environment, remote sensing technology is necessary. In particular, Synthetic Aperture Radar (SAR) which allows high-resolution observation in all-weather and day-night time is used in variety of fields [1]. Raw image data received by SAR needs to be applied image processing. In order to apply image processing, DSP had been often used. But recently, Field Programmable Gate Arrays (FPGA) has been used as its performance improved [2]-[4].

We are developing a Circularly Polarized (CP)-SAR system on small satellite. Since circularly polarized wave is not affected by earth's ionosphere, CP-SAR is expected to allow for more precise observation.

Now, we have a plan a verification experiment for CP-SAR using Unmanned Aerial Vehicle (UAV) [5]. To do image processing, our system apply Range Doppler Algorithm (RDA) to raw image data. In generally, taking into time of communication with the ground, image processing is executed on platform (plane and satellite). In this verification experiment, CP-SAR and image processing is executed on UAV with FPGA. After UAV landed on the ground, we analyze the data. To achieve semi-real-time observation, our system is needed to make one image in 60 second.

The rest of the paper is organized as follow. Section 2 introduces the preliminaries of SAR and FPGA. Section 3 shows our current system. Section 4 presents the proposed system. Section 5 evaluates and section 6 draws the conclusion.

## 2. Preliminaries

### 2.1. FPGA

FPGA is well known devices concerning reconfigurable hardware. FPGAs consist of an array of programmable logic blocks surrounded by a programmable routing fabric that allows blocks to be programmably interconnected. In high performance system, it has advantages in terms of cost and power consumption [6] [7]. In order to reduce the development period, various IP core has been provided by each vender. In this paper, we use IP Core Generator provided by Xilinx. The FPGA configuration is generally specified using a hardware description language. The features of flexibility, it is often used for control of the equipment with special purpose and aerospace equipment.

### 2.2. SAR

SAR, sends itself a microwave and measures the scattered waves, is active image radar enabling high azimuthal resolution in the resulting image despite a physically small antenna. The larger the antenna, the resolution of the image is higher, but there is a limit of increase the size of the antenna on satellite and plane. To achieve a large antenna virtually, small antenna observes many times in moving as shown in fig.1. A radar on satellite and plane is called platform. Fig.2 is the instrument arrangement and the name of the radar. Using a microwave characterized in that passing through the clouds, it can observe earth in all-weather and day-night time. Thus, it has been applied to an earthquake prediction by the monitoring of small crustal movement, an observation in a disaster and a geological survey.

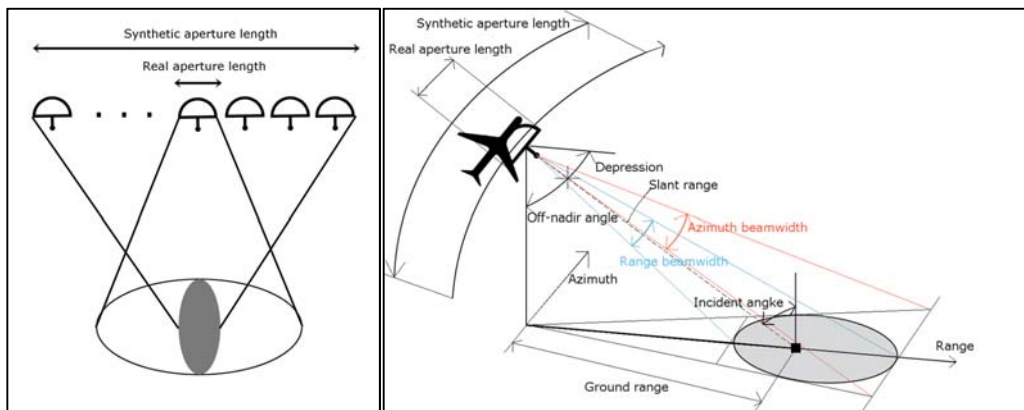

Figure 1. Synthetic Aperture Radar.

Figure 2. . The instrument arrangement and the name of the radar



SAR needs to send the data to the ground. But the raw data received by SAR is too large to communicate with the ground. It sends only the image processed on platform since it takes a long time and power.

SAR generally uses linearly polarized wave. Linearly polarized wave is received twice the Faraday effect at the time of transmission and reception as it passes through the ionosphere. However, circularly polarized is able to ignore the effect by having a uniform amplitude in all directions. Therefore CP-SAR is expected to be observed in the better than the SAR using linearly polarized wave [8].

### 2.3. Range Doppler Algorithm

Raw image data received by SAR needs to apply image processing in order to correct the gap which occurred due to the movement during observation. RDA is the commonly used algorithm for processing continuously collected SAR data into an image. The main steps of RDA used in our system are shown in fig.3. In collecting the SAR data, a long-duration linear FM pulse is transmitted. This allows the pulse energy to be transmitted with a lower peak power. The linear FM pulse has the property that, when filtered with a matched filter, the result is a narrow pulse in which all the pulse energy has been collected to the peak value. This matched filtering of the received echo is called range compression. Azimuth compression is a matched filtering of the azimuth signal, performed efficiently using Fast Fourier Transform's [1]. Our system only make a Single Look Complex (SLC) image by using RDA.

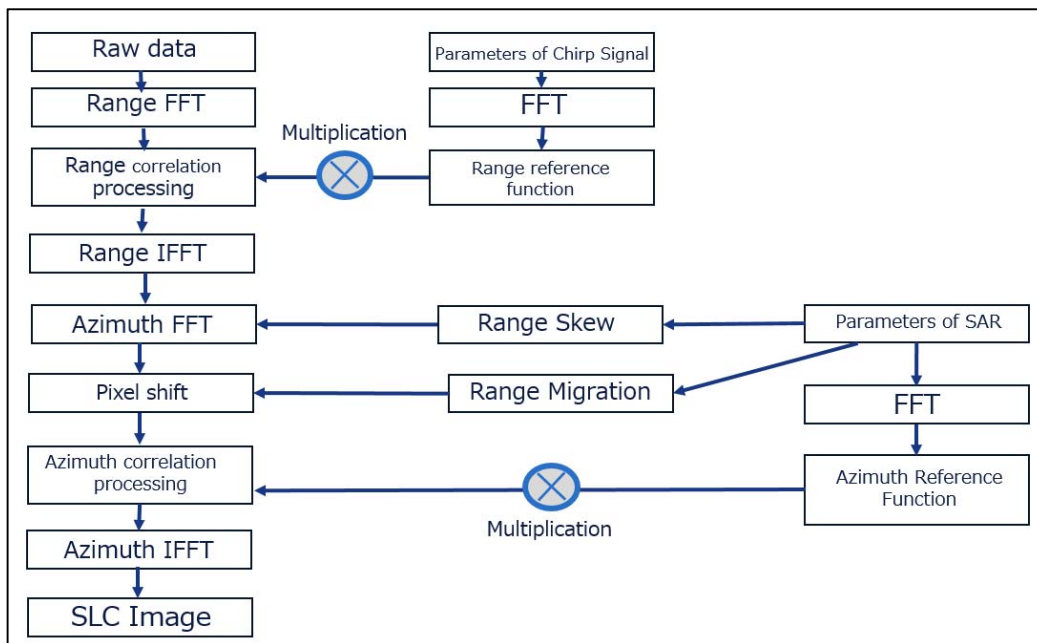

Figure 3. Chart of Range Doppler Algorithm.

## 3. Current System

Our system consists of 2 parts; signal processing of CP-SAR part and image processing part, as shown in fig.4. At first, signal processing part gets raw data by using CP-SAR and sends data including information of SAR to image processing part. After applying RDA at image processing part, the image data is saved in SSD.

Our image processing part in fig.5 has one PC which has Intel Atom processor and a Solid State Drive (SSD) and two FPGA Boards, Vertex-6 FPGA Board ML605 for the target device xc6vlx240t-1ffg1156 is used and Spartan-6 FPGA Board SP605. In ML605,

it receives raw data gained by signal processing part through Ethernet and apply RDA to make a SLC image. SP605 which connected to ML605 by FMC cable sends the image to PC to save. PCIe is used between SP605 and PC. These FPGAs is implemented in Verilog Hardware Descriptive Language (VHDL). Since our systems has one PC and two FPGA Board, it needs large power consumption, space and time.

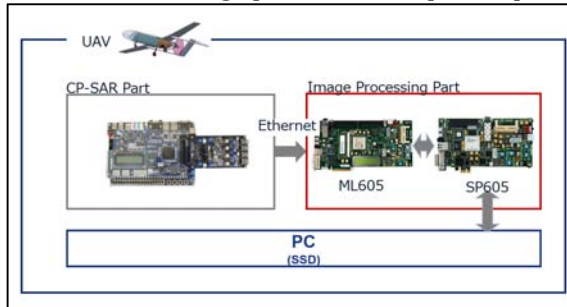

Figure 4. Current System.

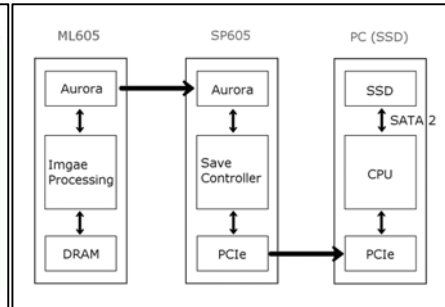

Figure 5. Image Processing Part.

#### 4. Proposed System

Our proposed system has only one FPGA Board Kintex-7

KC705 for the target xc7k325t-2ffg900c is used with XM104 Connectivity Card. Since current system has low resources, it has to need PC for control and divide system into 2 unit; image processing unit, data saving unit. When it saves the image to SSD, SP605 had to use the PC because SP605 does not have SATA port. However, XM104 which has SATA port does not need PC and SP605.

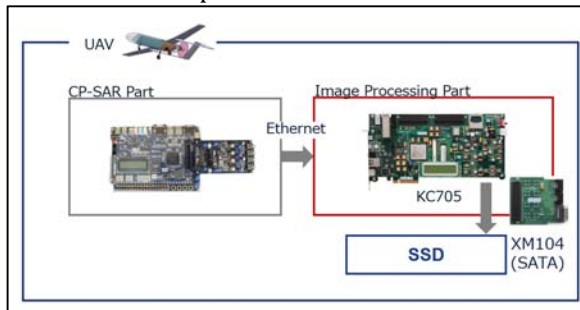

Figure 6. Proposed System.

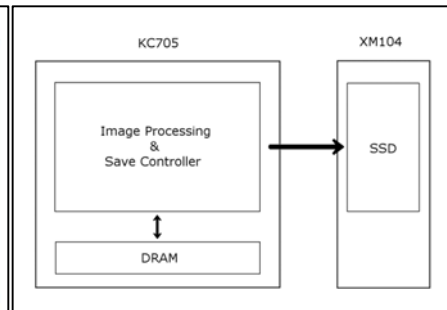

Figure 7. Image Processing Part in Proposed System.

#### 5. Evaluation

Our System is needed semi-time-observation, low space and low power consumption in order to observe on small satellite. Table I shows specification ML605 and KC 705[9] [10]. KC705 has 35% more logic cells than ML605. Current systems used 98% resources of ML605 only image processing. KC705 is expected to send or receive image data, to execute image processing, to save the image to SSD on only one board. Equipment on UAV has to be a space-saving, power-saving, lightweight. Fig.8, 9 and table 2 show comparisons of current system and proposed system. Proposed system can reduce 3.5kg than current system.

Table 1. Specification ML605 and KC705

Device	Logic Cells	Configurable Logic Blocks		DSP Slices	Block RAM Blocks		
		Slices	Max RAM(kb)		18kb	36kb	Max (kb)
ML605 (XC6VLX240T)	241,152	37,680	3,650	768	832	416	14,976
KC705 (XC7K325T)	326,080	50,950	4,000	840	890	445	16,020

Table 2. Weight and power of each system.

	weight (kg)
Current System	4.6
Proposed System	1.1



Figure 8. Overview of Current System.



Figure 9. Overview of Proposed System.

## 6. Conclusion

Comparisons of current system used ML605 and proposed system used KC705 is presented. SAR is an important technology in the field of global environment observation. Raw data received by SAR need to be executed image processing. Devices on UAV must be small since resources (space, power) are limited. KC705 which has more resources than ML605 is expected to reduce power consumption, space, time of development and modification. The proposed system is applicable to SAR image processing system on an UAV making semi-real-time observation.

## References

- [1] Ian G. Cumming and Frank Hay-Chee Wong (2005). Digital Processing Of Synthetic Aperture Radar Data, Artech House.
- [2] Lin Shuisheng, Wu Jinghong and Huang Shunji (1996). Real-time digital signal processing system of airborne SAR with ultra-high speed DSP, Signal Processing, 3rd International Conference on vol.1, pp.427-430.
- [3] Xin Xiao, Rui Zhang, Xiaobo Yang and Gang Zhang (2004). Realization of SAR real-time processor by FPGA, Geoscience and Remote Sensing Symposium, IGARSS '04. Proceedings. 2004 IEEE International, vol.6, pp.3942-3944.
- [4] Wai-Chi Fang, Charles Le and Stephanie Taft (2005). On-Board Fault-Tolerant SAR Processor for Spaceborne Imaging Radar Systems, Circuits and Systems. ISCAS 2005. vol.1, pp.420 – 423.

- [5] Masaru Bunya, Kazuteru Namba and Josaphat Tetuko Sri Sumantyo (2015). CP-SAR processing system on FPGA for multiple image size, The 18th Symposium on Environmental Remote Sensing.
- [6] Yutana Jewajinda (2013), A Performance evaluation of a Probabilistic Parallel Genetic Algorithm: FPGA vs. Multi-core Processor, 2013 International Computer Science and Engineering Conference (ICSEC), pp.298-301.
- [7] Brian Van Essen, Chris Macaraeg, Maya Gokhale and Ryan Prenger (2012). Accelerating a random forest classifier: multi-core, GP-GPU, or FPGA?, 2012 IEEE 20th International Symposium on Field-Programmable Custom Computing Machines, pp.232-239.
- [8] Heein Yang, Jin-Hong An, Hae-Won Jung and Jae-Hyun Kim (2014). Circular Polarization Implementation on Synthetic Aperture Radar, 2014 International Conference on Information and Communication Technology Convergence (ICTC) , pp.991-994.
- [9] Xilinx (2015), Virtex-6 Family Overview,  
[https://www.xilinx.com/support/documentation/data\\_sheets/ds150.pdf](https://www.xilinx.com/support/documentation/data_sheets/ds150.pdf)
- [10] Xilinx (2016), 7 Series FPGAs Overview,  
[https://www.xilinx.com/support/documentation/data\\_sheets/ds180\\_7Series\\_Overview.pdf](https://www.xilinx.com/support/documentation/data_sheets/ds180_7Series_Overview.pdf)

**Topic :** Novel Disaster Mitigation Engineering Toward Future

## **Smart disaster mitigation based on novel structures/materials**

Hiroshi Asanuma\*

*Chiba University, 1-33 Yayoicho, Inage-ku, Chiba-shi, Chiba 263-8522, Japan*

---

### **Abstract**

The author proposed to use novel technologies/materials such as smart structures/materials and related technologies to enable revolutionary prevention/mitigation of disasters. A typical example is the deployable breakwater which can be used daily for energy harvesting, small enough not to be an obstacle, as well as a smart breakwater autonomously deployable by the force/energy and material of tsunami or high wave. The author discussed with Furuya and Nonami on new reliable approaches to cope with disasters, which intends to enable sustainability as well as disaster mitigation, and they named it as "Disaster Mitigation and Sustainable Engineering." The author et al. are establishing a research committee as a part of JSME M&P Division. In this paper, new ideas and developments for smart disaster mitigation toward future especially based on smart structures/materials are described. To explain the proposed concept more comprehensively, two examples, that is, an artificial forest and a novel deployable structure based on honeycomb to be used against flooding are introduced. Many other smart challenges and products are also introduced and future directions are discussed. Several projects are mainly undergoing by the author and/or his collaborators. Various outstanding challenges have been also done in industries and some are already commercialized. Disaster Mitigation and Sustainable Engineering has to be brushed up to become a basis for the above introduced emerging field with more variety of disasters to be smartly overcome or rather utilized.

### **Keywords**

disaster, tsunami, flooding, sustainability, deployable structure, energy harvesting, daily use

---

## **1. Introduction**

In recent years, more serious disasters occur around the world than in the past, and a large number of people are lost in spite of the rapid advancement of science and technology. In order to solve this problem, the author et al. have proposed a new concept "Disaster Mitigation and Sustainable Engineering" which enables sustainability as well as disaster mitigation, effectively and economically. It is emphasized that this novel concept can be effectively realized by the innovative field "Smart Materials and Structures." The

---

\* Corresponding author. Tel.: +08-43-290-3201; fax: +08-43-290-3039.  
E-mail address: asanuma@faculty.chiba-u.jp

number of presentations in this field at JSME (The Japan Society of Mechanical Engineers) annual meeting (MECJ) has been increasing, and it has also become a nucleation site for developing new innovative fields. A couple of research committees have been managed for many years, and as one of them, “Active Material Systems” Technical Section which belongs to the M&P (Materials and Processing) Division of JSME has been playing an important role to support and activate the field. Its major applications have been explored in mechanical, electronics, civil, architecture, aerospace, automobile, transportation, biomedical, and so on. But, since the Japanese earthquake and tsunami disasters on March 11, 2011, Asanuma et al. had proposed the new concept briefly mentioned above and have been exploring a completely new and effective direction for disaster mitigation.

## 2. Disaster mitigation and sustainable engineering

The new concept “Disaster Mitigation and Sustainable Engineering” can be briefly explained using the typical examples shown in Figure 1 and Figure 2. Serious disasters may occur today or may not for a long period of time. The structures necessary for disaster mitigation need vast amount of construction and maintenance costs. So, we better think of using them daily to produce something useful such as energy. The generated energy can be used for their monitoring, maintenance, corrosion suppression, repair, and many other purposes such as lighting, charging drones, and so on. The disaster mitigation devices and structures have to be available even if disaster occurs once for hundred years. For the overwhelming period without disasters, they are not necessary from disaster mitigating point of view, so their compactness is very useful from daily and aesthetic point of view. In addition, a “Smart Furniture” to protect valuable products from falling from shelves etc. at the time of earthquake has been considered. Asanuma et al. introduced the concept etc. at the Chiba Univ. symposium on Jan. 26 and also at the MECJ-12 on Sep. 11, 2012 [1, 2]. In addition, several invited talks etc. such as keynotes at MECJ, MRS-J and PT-PIESA 2013 have been delivered by Asanuma [3, 4 and 5].

Asanuma and Furuya are establishing a research committee with Nonami, Maeno, Yamazaki, Igarashi, Kudo, Takahashi, Shimazu, Sumantyo, Kubo, Maruyama, Tanaka, Lu, Takei, Koyama, Okawa et al. from Chiba Univ., and Su (NASA), Shahinpoor (Univ. of Maine), Paolozzi, Felli (Sapienza Univ. of Rome), Nejhad, Hihara (Univ. of Hawaii at Manoa), Aimmanee, Ekkawatpanit (King Mongkut’s Univ. of Tech. Thonburi), Adachi (Chubu Univ.), Yanaseko (Kogakuin Univ.), Vendittozzim, Santilli (Univ. of Brasilia), Dry (Natural Process Design), Yan (Missouri Univ. of Sci. and Tech.), Kishimoto (NIMS), Furukawa (Yamagata Univ.), Nakao (Yokohama National Univ.), Kosaka (Kochi Univ. of Tech.) et al. are also extending it to be more active and international one.

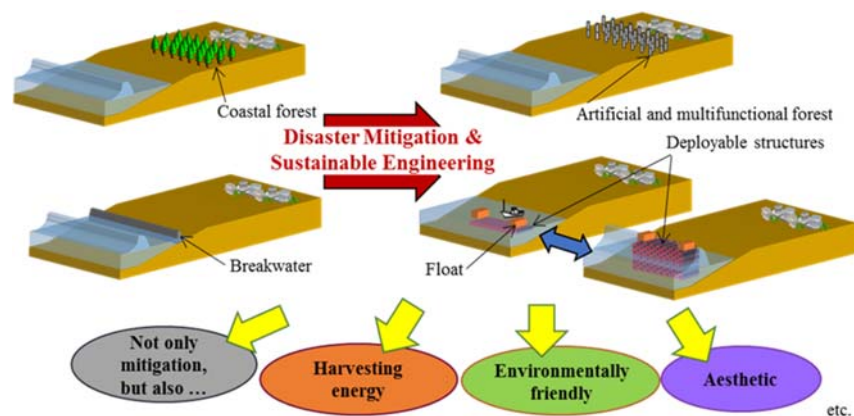

Figure 1. Typical examples to show the concept of “Disaster Mitigation and Sustainable Engineering.”

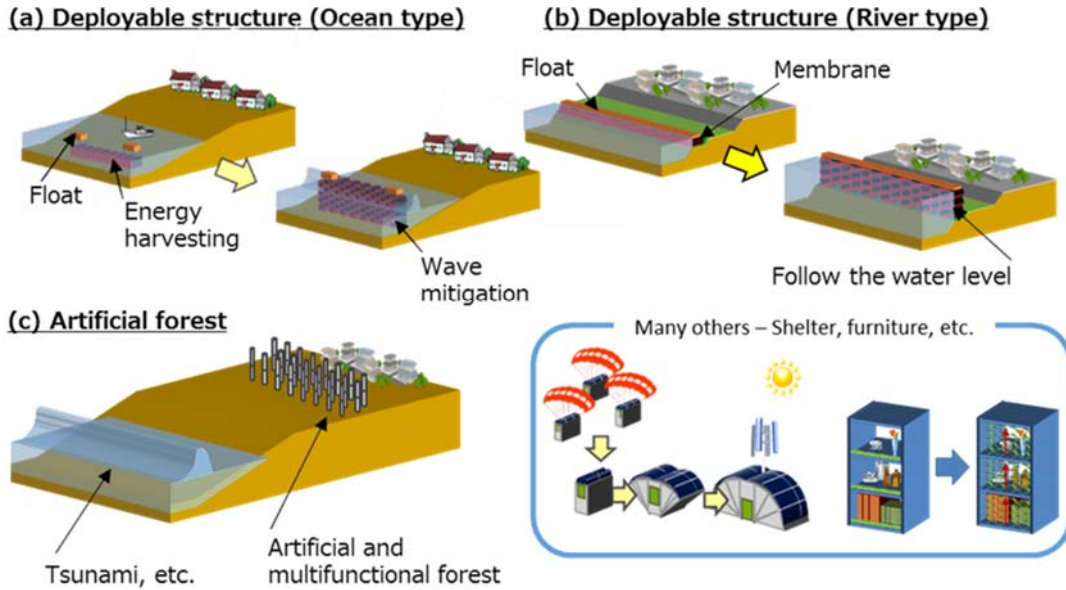

Figure 2. Examples to realize the concept.

First of all, in order to explain the concept more comprehensively, two examples having been experimentally done are mainly introduced and discussed. As the first example, an artificial forest has been developed, which are intended to have better capability of high wave or tsunami mitigation than actual ones [6, 7], by optimizing various parameters such as configuration, density and material. Natural forests have many problems such as low fraction of trees, low visibility of ocean waves, low strength, long time to grow, and so on.

The first two experimental parameters have been mainly examined by using a water channel set-up prepared for this research. Multifunctional design is also described. As the second example, a new smart structure based on honeycomb like one to be used against flooding etc. is proposed and demonstrated to show the possibility of autonomously deployable due to increase of water level as external environmental change. This autonomous height-controlled river or anti-flooding bank system can be regarded as a smart structure. Energy harvesting materials and systems are under consideration and development to make the system much smarter and fully realize the concept.

Secondly, several challenges toward future mostly done by the authors, and several smart products from industries and projects are introduced, and finally, the content is summarized

### 3. Experimental and future works

#### 3.1 Artificial forests [8]

An aquarium as shown in Figure 3, consisting of 300 mm wide and 4500 mm long waterway and hydraulic bore water tank, was used, and an artificial forest model, consisting of 4 mm diameter and 300 mm long columnar bars, was arranged as shown in Figure 4, where lattice spacing  $S$  and number of rows  $N$  were changed. It was placed in the range of 2780 to 3180 mm from the gate of water tank. Stage type wave was generated by setting the initial water height of the waterway  $h_o = 30$  mm and the initial water height of the water tank  $H = 240$  mm, and opening the gate. In this case, the generated hydraulic bore is the state of supercritical flow, of which flow rate is 1.5 m/s and Froude number is 1.5 at the front edge (tank side) of the model.

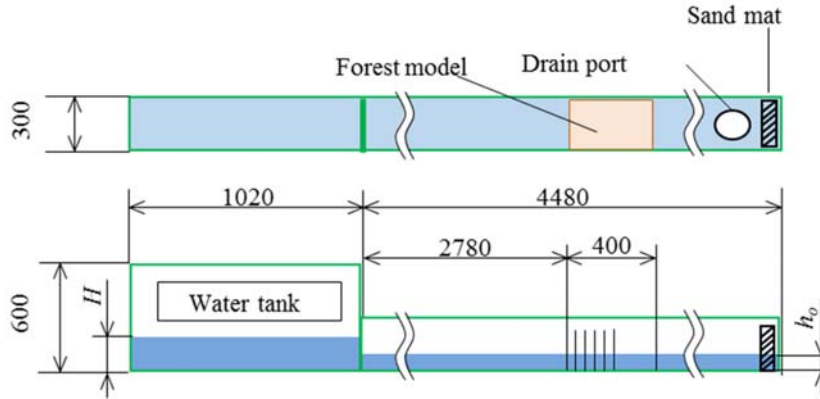

Figure 3. Schematic of experimental waterway.

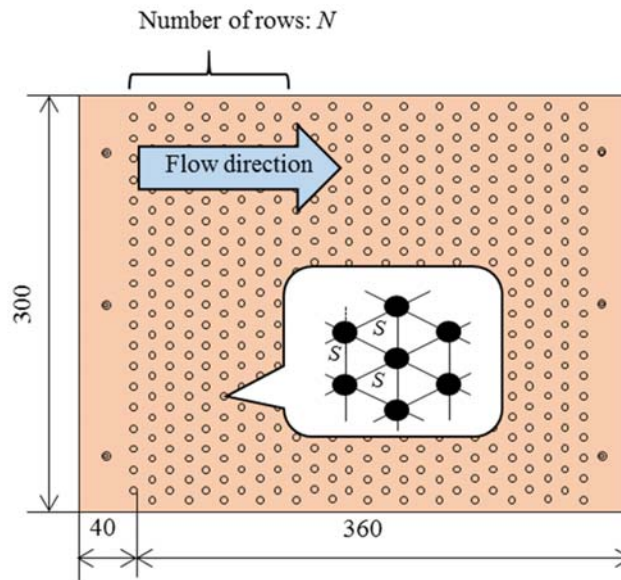

Figure 4. Schematic of metal plate to arrange cylinders.

To observe the state of flow passing through the artificial forest model, photos were taken from the above and the side positions with a digital camera. Then, by using an image processing software, flow rate and water level at the front and the end of the cylinder group model were measured, and reduction of those were used to evaluate wave mitigation effect.

From the preliminary studies [9], the arrangement shown in Figure 4 is better than square one, and smaller spacing  $S$  is also better. Therefore, the effect of type of material, that is, polyacetal (POM) and stainless steel (SUS304) were compared as a function of number of rows  $N$  from 1 to 12 at the minimum and constant  $S (= 15)$ . In Figure 5, the water flow interacting with the artificial forest model made of POM cylinders is shown. In the case of  $N = 12$ , remarkable reflection of the incident wave can be observed in front of the model, and remarkable reduction of the water level and hydraulic jump phenomenon can be observed behind it.

In Figure 6, reduction rate of water flow velocity as a function of number of rows is shown. According to the figure, the reduction rate increases with increasing number of rows for both materials, and those of POM are generally higher than those of SUS304 except  $N = 1$  and 2. This tendency is considered to be caused due to the difference of Young's moduli of the materials, that is, POM having lower Young's modulus can absorb





(a)  $N = 1$

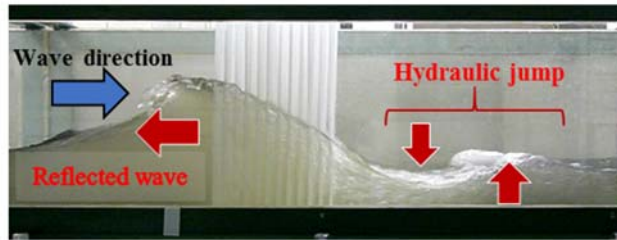

(b)  $N = 12$

Figure 5. Side views of water flow experiments using POM cylinders of number of rows (a)  $N = 1$  and (b)  $N = 12$ .

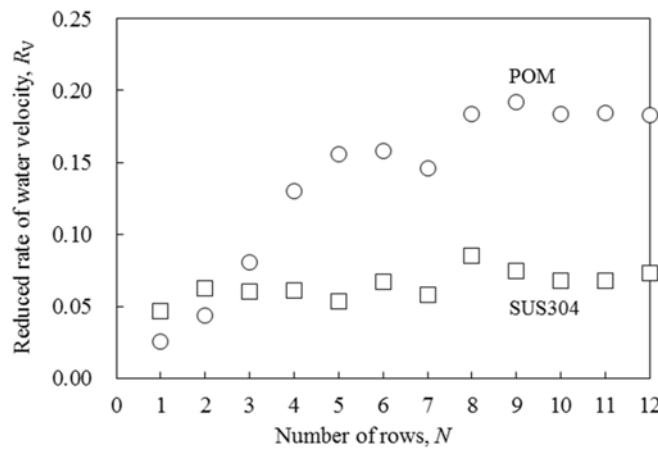

Figure 6. Effect of number of rows  $N$  on reduction rates of water velocity  $R_v$  for the cases of POM and SUS304.

the kinetic energy of water flow.

As the next step of this research, the poles are planned to be integrated with voltage generation or energy harvesting function using vibration of the poles due to air flow and/or water flow. To realize this, electroactive polymers, piezoelectric materials, etc. are under investigation to be applied, or conventional electro-mechanical systems can be used for a while.

### 3.2 Deployable structure [8]

In Figure 7, a schematic drawing of the deployable honeycomb structure model is shown. In this study, the cell shape was designed based on the assumption that the cell is made of 0.2 mm thick aluminum (A1050-H24) and can elastically deform up to the double of its original height. The actual model designed to follow the height of water level with a float (POM cylinder) to lift the model and a membrane (PVC) to stop water flow, which are attached to L-shape aluminum frames on both vertical sides of the structure to obtain

higher stiffness in the direction of water flow. This model was set in the same water channel as used for the artificial forest experiment and water was supplied at the rate of 1.3 l/s up to 150 s where overflow started. Then the water flow was stopped and the water level reduced. The heights of the water level and the top of the structure were measured.

In Figure 8, the actual model is shown at the initial and the successfully deployed states. Above this level, the supplied water overflowed. This system can be regarded as a smart structure because its height is found to be in autonomously proportion to the water height and its change as an environmental state in the experimental range. As the next steps of this research, the authors are trying to embed functional materials such as piezocomposites and IPMCs to make the structure multifunctional and smarter.

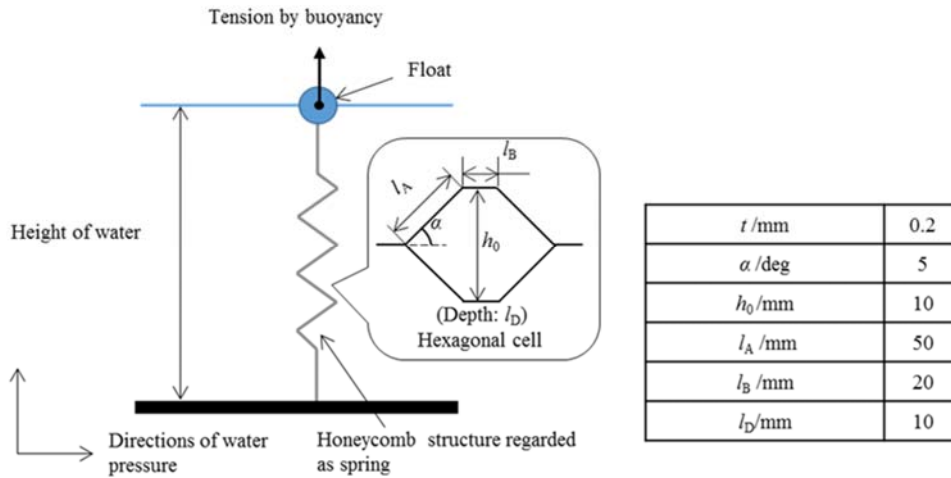
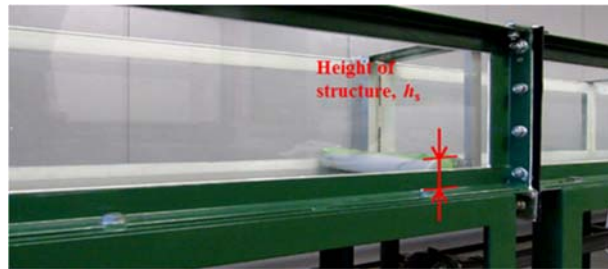

Figure 7. Schematic of deployable structure model.



(a) Initial state



(b) Deployed state

Figure 8. The actual deployable structure model at (a) initial and (b) deployed states.

### 3.3 Challenges toward future

The following researches are mainly undergoing by the authors et al.

- 1) Applications of Piezoelectric Polymers in Electrical Power Generation Using Ocean Waves [10].
- 2) Dynamic Deployment of Smart Inflatable Tsunami Airbags (TABs) for Tsunami Disaster Mitigation [11].
- 3) A Novel Underwater Inflatable Structures for Smart Costal Disaster Mitigation [12].
- 4) Structural Health Monitoring of Pipelines for Environment Pollution Mitigation [13].
- 5) The Contribution of LARES to Global Climate Change Studies with Geodetic Satellites [14].
- 6) Smart Disaster Mitigation in Italy [15].
- 7) Smart Disaster Mitigation in Thailand.

The following one is also undergoing. In order to cope with tsunamis, rigid and fragile structures are not suitable, and rather strong, light and flexible structures are preferred, Asanuma et al. have started to develop a multi-layered flexible and deployable structural material system to diminish the force of tsunami and dissipate its energy by separating water flow and letting them conflict with each other as briefly shown in Figure 12 [16], which was presented as a part of the plenary lecture at the International Innovation Workshop on Tsunami, Snow Avalanche and Flash Flood Energy Dissipation (January 21-22, 2016, Lyon, France) where lots of innovative ideas and challenges such as offshore mega-floating structures with energy harvesting function as well as dissipation function were introduced and future works were discussed [17].

## 4. Products from industries and projects

Various challenges have been done in industries and some are already commercialized. In Figure 13, one of the products successfully developed by Hitachi Zosen Corporation is schematically shown. The neo RiSe® (no energy, no operation, Rising Seawall) land-mounted movable flap-gate type seawall can be autonomously deployed by using the force of tsunami [18, 19].

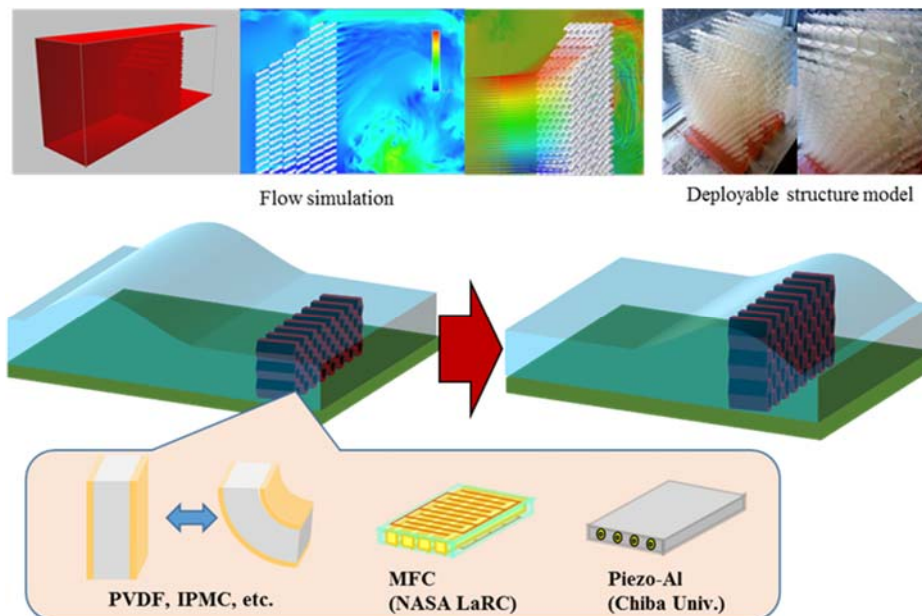

Figure 9. A new design of tsunami barrier using computational fluid dynamics (CFD), and its next plan to be multifunctional.

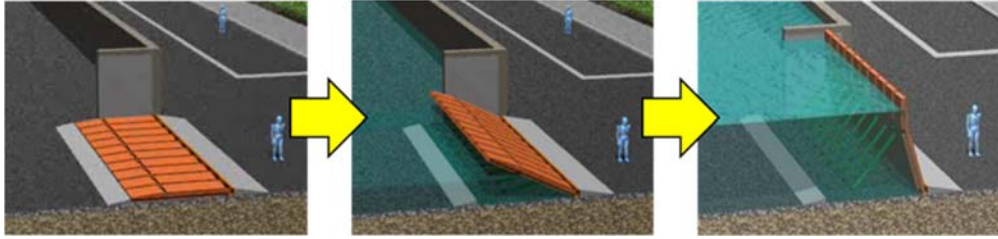

Figure10. The neo RiSe land-mounted flap gate embankment system (Courtesy of Mr. K. Nakayasu (Hitachi Zosen Corporation)).

Project MOSES, Aqua Dam, Inflatable Flood Barriers, Inflatable Rubber Dam, Water-Gate are also attractive examples. In addition to the above mentioned products, Takenaka Corporation proposed innovative “Breakwater and breakwater group [20].”

## 5. Summary

New ideas and developments for smart disaster mitigation toward future especially based on smart structures/materials are described in this paper. The proposed concept “Disaster Mitigation and Sustainable Engineering” is the key and explained more comprehensively. Two examples having been tried experimentally to realize the concept are shown. As the first example, artificial forests are examined to have better capability of high wave or tsunami mitigation by changing various parameters such as configuration, density and material. Multifunctional design is also mentioned. As the second example, a novel deployable structure based on honeycomb to be used against flooding etc. is proposed and demonstrated to be autonomously deployable due to increase of water level. This autonomously height-controlled river or anti-flooding bank system can be regarded as a smart structure. Energy harvesting materials and systems are under consideration and development to make the system smarter and fully realize the concept. Many other smart challenges and products are also introduced and future directions are discussed.

## Acknowledgments

The authors thank Mr. K. Nakayasu (Hitachi Zosen Corporation) for his kind offer of valuable information.

## References

- [1] Asanuma, H., “The 1st Symposium on Disaster Mitigation and Sustainable Engineering,” Chiba University, 23 January 2012. <[http://www.chiba-u.ac.jp/others/topics/article2011/pdf/gensai\\_sympo.pdf](http://www.chiba-u.ac.jp/others/topics/article2011/pdf/gensai_sympo.pdf)> (20 February 2016).
- [2] Asanuma, H., Furuya, Y., Kubo, M., Maruyama, Y., Tanaka, G., and Yanaseko, T., “Application of Smart Materials and Structural Systems to the Area of Disaster Mitigation,” MECJ-2012, J044082 (CD-ROM) (2012).
- [3] Asanuma, H., “Smart Materials and Structural Systems and Their Potential Applications to the Field of Disaster Mitigation and Sustainable Engineering,” MECJ-2013, K04200 (CD-ROM) (2013).
- [4] Asanuma, H., Furuya, Y., Yanaseko, T., and Oshima, K., “Disaster Mitigation and Sustainable Engineering Based on Smart Materials and Structural Systems,” 23rd Annual Meeting of MRS-J, G-K10-006 (CD-ROM) (2013).

- [5] Asanuma, H., "Development of Smart Mechanical Material Systems," 4th Scientific Symposium of the CRC/TR 39 "PT-PIESA," 26-27 March 2013. <[http://www.pt-piesa.tu-chemnitz.de/symposium/4.Symposium/DE/img/Agenda\\_A4.pdf](http://www.pt-piesa.tu-chemnitz.de/symposium/4.Symposium/DE/img/Agenda_A4.pdf)> (20 February 2016).
- [6] Harada, K., and Imamura, F., "Effects of Coastal Forest on Tsunami Hazard Mitigation, Tsunami - Case Studies and Recent Developments," Springer, 279-292 (2005).
- [7] Kitamura, K., and Maruyama, Y., "Estimation of Tsunami-Inundated Areas in Asahi, Chiba after the 2011 Off the Pacific Coast of Tohoku Earthquake," Proceedings of the 31st Workshop of Earthquake Engineering (JSCE meeting), 5-025 (CD-ROM) (2011).
- [8] Asanuma, H., Su, J., Shahinpoor, M., Felli, F., Paolozzi, A., Nejhad, M., Hihara, L., Aimmanee, S., Furuya, Y., Yanaseko, T., Okabe, S., "Development of Disaster Mitigation and Sustainable Engineering Based on Smart Materials and Structures," WECC 2015, Paper No. 20344 (CD-ROM), 29 November- 2 December 2015, Kyoto, Japan.
- [9] Asanuma, H., Yanaseko, T., Suzuki, H., Katayama, D., and Oshima, K., "A Fundamental Study on Designing Smart Wave Mitigation Structures," MECJ-2014, S0430101 (CD-ROM) (2014).
- [10] Su, J. and Asanuma, H., "Applications of Piezoelectric Polymers in Electrical Power Generation Using Ocean Waves," SPIE Smart Structures/NDE 2015, 12 March 2015, San Diego, California, USA.
- [11] Shahinpoor, M., and Asanuma, H., "Dynamic Deployment of Smart Inflatable Tsunami Airbags (TABs) for Tsunami Disaster Mitigation," Proc. of the ASME 2015 Conference on Smart Materials, Adaptive Structures and Intelligent Systems, V002T04A007 (2015).
- [12] Adachi, K. and Asanuma, H., "A Novel Underwater Inflatable Structures for Smart Coastal Disaster Mitigation," ASME 2015 Conference on Smart Materials, Adaptive Structures and Intelligent Systems (SMASIS2015-9082), 21-23 September 2015, Colorado Springs, Colorado, USA.
- [13] Felli, F., Paolozzi, A., Vendittozzi, C., Paris, C., Asanuma H., De Canio G., Mongelli M., Colucci A., "Structural Health Monitoring of Pipelines for Environment Pollution Mitigation," Proc. of the ASME 2015 Conference on Smart Materials, Adaptive Structures and Intelligent Systems, V002T04A009 (2015).
- [14] Sindoni, G., Paris, C., Vendittozzi, C. E., Pavlis, C., Ciufolini, I., Paolozzi, A., "The Contribution of LARES to Global Climate Change Studies with Geodetic Satellites," Proc. of the ASME 2015 Conference on Smart Materials, Adaptive Structures and Intelligent Systems, V002T04A010 (2015).
- [15] Felli, F., Palozzi, A., Vendittozzi, C., Paris, C., "Smart Disaster Mitigation in Italy - A Brief Overview on the State of the Art," Proc. of the ASME 2014 Smart Materials, Adaptive Structures and Intelligent Systems (Paper no. SMASIS2014-7631), vol. 2 pp. V002T04A018, 8-10 September 2014, Newport, Rhode Island, USA.
- [16] Asanuma, H., Shahinpoor, M., Su, J., Adachi, K., Kubo, M., Maruyama, Y., Tanaka, G., "Disaster Mitigation and Sustainable Engineering Based on Smart Structures," 21-22 January 2016, International Innovation Workshop on Tsunami, Snow Avalanche & Flash Flood Energy Dissipation, <[http://www.fri.niche.tohoku.ac.jp/workshop2016/data/20160122/tsunami\\_ws\\_2016\\_H\\_ASANUMA.pdf](http://www.fri.niche.tohoku.ac.jp/workshop2016/data/20160122/tsunami_ws_2016_H_ASANUMA.pdf)> (20 February 2016).
- [17] <<http://www.fri.niche.tohoku.ac.jp/workshop2016/>> (20 February 2016)
- [18] <<http://www.hitachizosen.co.jp/english/products/products026.html>> (20 February 2016).
- [19] Shirai, S., Nagata, S., Fujita, T., Niizato, H., Nakayasu, K., and Takahashi, K., "Development of Flap Type Mobile Gate for Protection against Storm Surge and Tsunami," Proc. of Civil Engineering in the Ocean, 21, 109-114 (2005).
- [20] Nishioka et al, "Breakwater and breakwater group," application number P2011-129500, applied on July 5, 2011 in Japan.

Topic : Earth and Planetary Science

## **Seismological Evidence for Crustal Deformation beneath the Sunda-Banda Arc Transition Zone**

Syuhada Syuhada <sup>a, b\*</sup>, Nanang T. Puspito<sup>c</sup>, Nugroho D. Hananto<sup>d</sup>, Chalid I.  
Abdullah<sup>e</sup>, Titi Anggono<sup>c</sup> and Tedi Yudistira<sup>c</sup>

<sup>a</sup> Graduate Research on Earthquake and Active Tectonics, Institut Teknologi Bandung  
(ITB), Bandung, Indonesia

<sup>b</sup> Research Centre for Physics - Indonesian Institute of Sciences (LIPI), Tangerang, Indonesia

<sup>c</sup> Faculty of Mining and Petroleum Engineering, ITB, Bandung, Indonesia

<sup>d</sup> Research Centre for Geotechnology- LIPI, Bandung, Indonesia

<sup>e</sup> Faculty of Earth Sciences and Technology, ITB, Bandung, Indonesia

---

### **Abstract**

Recent seismological studies involving a large amount of receiver function and shear wave splitting data recorded by regional Geofone-IA stations have been conducted in the Sunda-Banda Arc transition zone. This region is characterized by a change in tectonic regime from subduction of Indo-Australia plate along the eastern part of Sunda Arc to collision of the Australian continental plate with islands arc in the western part of the Banda Arc. The previous receiver function results reveal variation in crustal structure and properties due to the influence of the change in tectonic regime from subduction to collision. The recent shear wave splitting results also show variation in the direction of the shear wave fast polarisations, suggesting that anisotropy is either caused by preferentially aligned cracks related to the stress field or structural fabrics related the aligned macroscopic fractures and anisotropic minerals. These variations are suggested to be related to the change in tectonic setting. In this report, we extend our analysis using spatial averaging fast polarizations to reveal some features that might be connected to the structure variation due to the change of tectonic regime. The spatial averaging method reveals that the average fast polarisations of the splitting waves are consistent with the trending structural discontinuity that might be presence in this region. This result is in good agreement with other geological and geodetical studies conducted in the Sunda-Banda arc transition zone.

### **Keywords**

Sunda-Banda Arc transition zone; Crustal structure; Receiver function; Shear wave splitting; Crustal anisotropy

---

---

\* Corresponding author.  
E-mail address: hadda9@gmail.com

## 1. Introduction

Sunda-Banda arc transition zone is marked by transition in tectonic setting from subduction in west of Sumba Island to collision in east of Sumba Island (Fig. 1). The evolution and origin of Sumba Island itself is still debated (e.g. Rutherford et al., 2001; Abdullah et al., 2000). Seismic reflection and refraction studies (e.g. Shulgin et al., 2009; Luschen et al., 2011) found that this area is highly deformed providing variation in structure and morphology. This region is also characterized by the presence of two major structure discontinuities dividing the region into three tectonic blocks (Nugroho et al., 2009). First, Major tectonic discontinuity separating between the Sunda arc and Banda arc has been hypothesized based on the discontinuity line of volcanism located between Sumbawa and Flores Islands (Audley-Charles, 1975). Another hypothesized structure discontinuity based on the uplift different of coral reefs is located along Pantar Strait (Nishimura and Suparka, 1986).

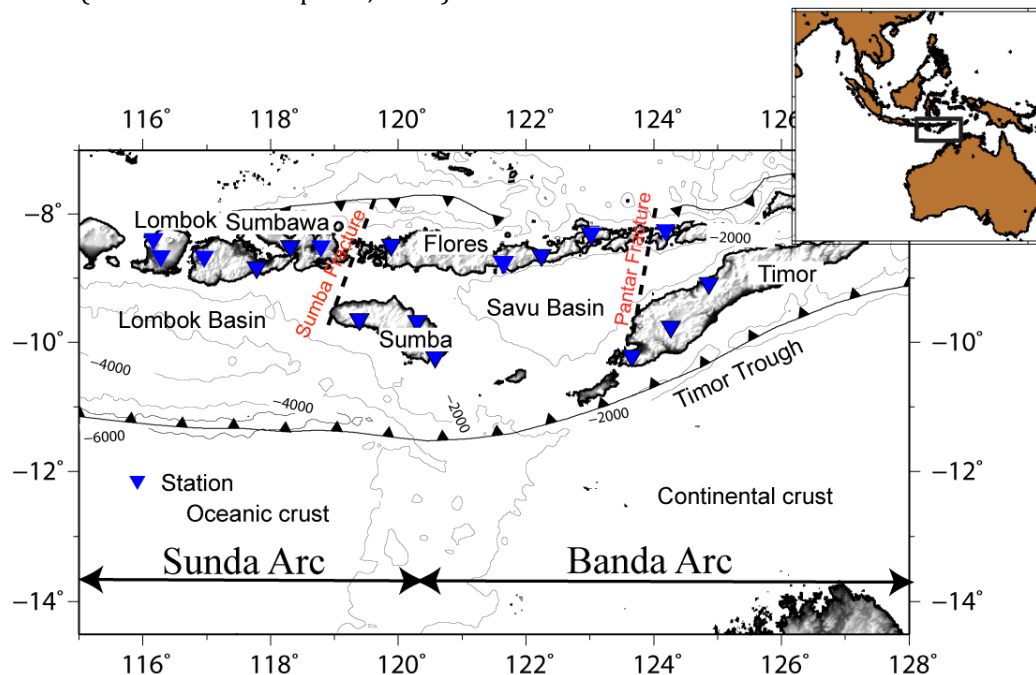

Fig 1. Tectonic setting of the study area. The inverted blue triangles denote seismic station used in this report. The bathymetric contours plotted from Sandwell and Smith (2009).

Recent seismological studies have conducted in order to substantiate variation in crustal structure and deformation pattern as result of the change of tectonic regime from subduction to collision (Syuhada et al., 2016a; Syuhada et al., 2016b). Previous receiver function study (Syuhada et al., 2016a) reveals that the Moho depth varies between 26-38 km, and the deeper Moho found at seismic stations located in the collision domain suggest the influence of the underplating of buoyant Australian crust during the arc-continent collision. The study area also has high  $V_p/V_s$  ratio which might be related to the local geological features such as the presence of mafic and ultramafic materials, fluid filled fracture zone and partial melt due to geothermal activities in the upper mantle. The shear wave splitting results (Syuhada et al., 2016b) show that the fast directions in the subduction domain are consistent with the directions of the principal compressional strain-rate axes, suggesting that anisotropy is mainly caused by stress induced anisotropy. On the contrary, more scattered fast directions are shown in the collision domain, indicating that anisotropy is either caused by preferentially aligned cracks related to the stress field or structural fabrics related the aligned macroscopic fractures and anisotropic minerals. Recent 2D delay time tomography derived from the

shear wave splitting measurements (Syuhada et al., 2016c) also found strong anisotropy related to the geological features as possible sources of seismic anisotropy in this area. This previous study suggests that strong anisotropy found in Timor Island related to the preferential alignment of anisotropic minerals, whereas strong anisotropy in Sumba Island corresponds to micro-cracks in the lower crust resulted from the interaction between the crustal root of Sumba and the Australian Plate. In this report we extend our analysis to map crustal deformation pattern using spatial averaging of fast polarization derived from shear wave splitting measurements.

## 2. Data and Method

In this research, we use the same seismic dataset as in the previous anisotropic study (Syuhada et al., 2016c). The dataset consists of seismograms recorded between 2008 and 2015 by 17 GEFONE-BMKG stations distributed in both two tectonic domains: subduction and collision (Fig. 1). All events used for the study have hypocenter depth less than 30 km to avoid contamination from mantle anisotropic sources. Splitting parameters are then computed using the automated shear wave splitting package (MFAST) (Savage et al 2010). Shear wave splitting occurs when a polarized shear wave propagates through an anisotropic medium and splits into two quasi shear waves with different polarizations and speeds. The shear wave splitting technique then measures the fast polarization direction ( $\phi$ ) and the delay time ( $\delta t$ ) between fast and slow waves.

The MFAST code works based on eigen value minimization (Silver and Chan, 1991) and cluster analysis (Teanby et al., 2004). To compute shear wave splitting parameters, we follow the procedure as described in the previous study [Syuhada et al., 2016b and 2016c]. First, we only use seismograms which have clearly S-arrivals and incident angle within 35°. In MFAST, we then apply multiple filters to look for the best filter based on signal to noise ratio (SNR > 3). The seismograms resulted from the best filter are then used for the splitting measurements. The splitting results are then graded based on SNR, stability of cluster and error analysis. In this report, we only employ the splitting results with grading A or B (AB grade) for further analysis (Fig. 2).

We then use TESSA package to examine spatial variation of fast polarisations (Johnson et al., 2011). In this package, Spatial averages of  $\phi$  are computed by averaging  $\phi$  calculated from each event-station pair in particular grid block. Each block is set to be 32 km x 32 km. Tomographic weighting scheme is derived from the previous study to calculate average  $\phi$  in grid blocks (Syuhada et al., 2016c). This weighting factor works based on variations due to heterogeneous anisotropic structure. Therefore, more weighting is given for the blocks containing higher degree of anisotropy. The weighting function  $\omega$  then can be formulated as (Johnson et al., 2011):

$$\omega_{rb} = S_b / \delta t_r$$

Here,  $r$  is the ray propagating through block  $b$ . Then the weighted average of  $\phi$  for  $n$  rays in each block is:

$$\overline{\phi}_b = \frac{1}{2} \arctan \left( \frac{\sum_{r=1}^n \cos(2\phi_r) \times \omega_{rb}}{\sum_{r=1}^n \sin(2\phi_r) \times \omega_{rb}} \right)$$

We only calculate the average when block consists of at least eight ray path (Fig. 3).



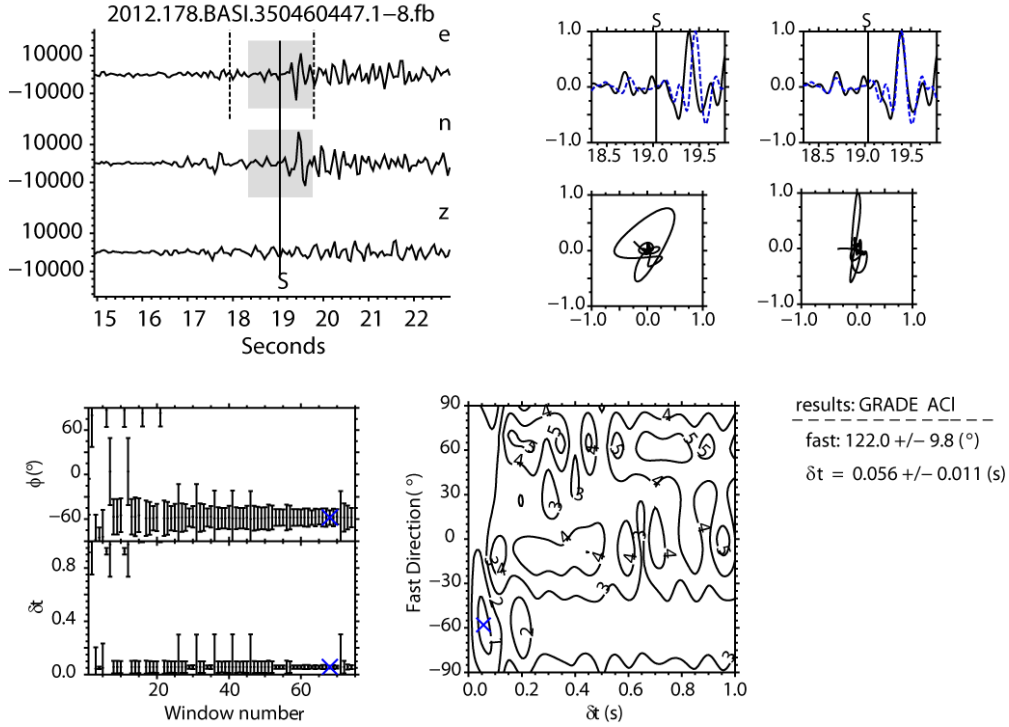

Fig. 2 An example of the splitting parameters derived from MFAST code. The top left panel shows the original three component seismogram. The top right panels depict the waveform and particle motions of S wave before and after correction. The below panels represent the cluster analysis and the contour diagram providing the best splitting measurement denoted by the blue crosses.

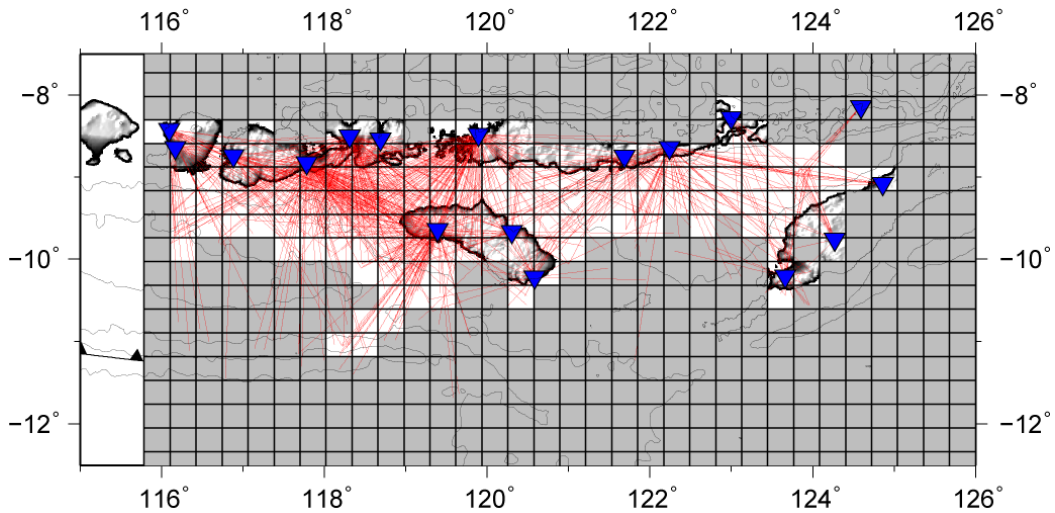

Fig. 3 Grids and rays (red lines) used for the spatial averaging. The grey boxes represent square boxes containing rays less than 8 rays and thus are discarded from the analysis.

### 3. Result and discussion

Fig. 4 displays the rose diagram of  $\phi$  and the weighted average of  $\phi$  obtained for each grid block. Here, we only plot the spatial average of  $\phi$ , if the standard deviation and the standard error of the mean are less than  $30^\circ$  and  $20^\circ$ , respectively. We observe that the

direction of  $\phi$  spatial averages beneath Sumba and Savu Basin varies between NE-SW and SE-NW. We suggest that this region is densely fractured as resulted from the collision process (e.g. Johnson et al., 2011). We also observe that weighted means of  $\phi$  depict consistent regional patterns dominated by NE-SW direction near Lombok Basin. This direction is parallel to the principal compressional axis of the strain rate (Bock et al., 2003). This result suggests that anisotropy beneath Lombok Basin might be related to dilatancy of fracture zones causing a fast wave polarisation parallel to the maximum horizontal stress (Boness and Zoback, 2006).

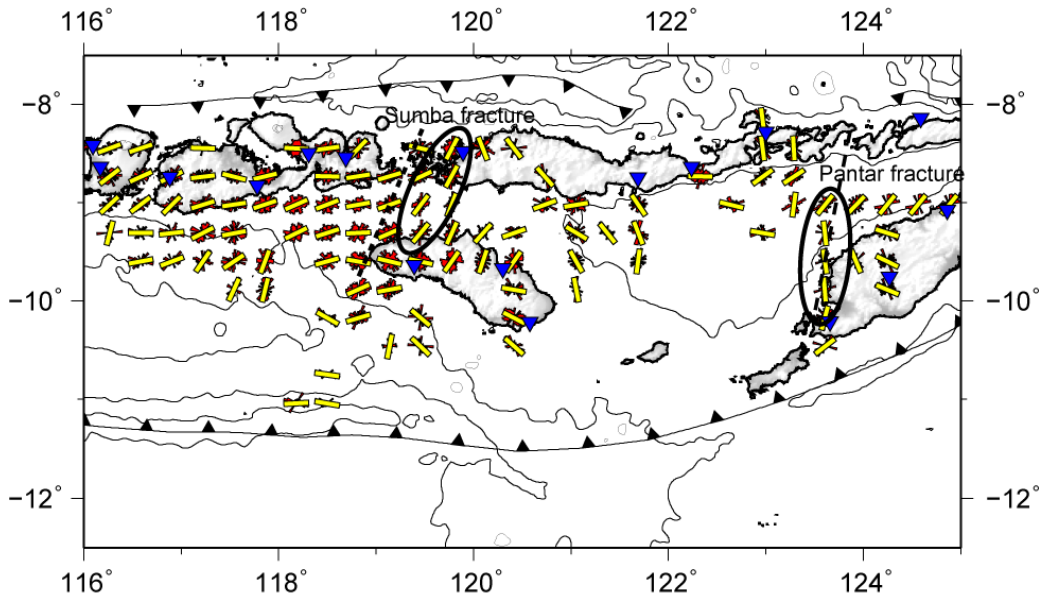

Fig. 4 Map of the spatially averaged fast orientations using 32 km grid blocks. Red rose diagrams represent all measurements in each individual block containing at least 8 passing rays. The yellow bars denote the mean fast orientation in each block with the standard deviation  $< 30^\circ$  and the standard error  $< 20^\circ$ . The black ellipses represent the places in which the mean fast directions are aligned parallel to the trending structural discontinuities.

The most striking feature in the spatial averaging results is the change of fast polarisations from generally NE-SW fast direction in the north-west of Sumba and NW-SE directions in the north-west of Savu Basin to almost N-S direction in the north of Sumba at around  $120^\circ\text{E}$ . We suggest that this pattern could be related to the trending structural discontinuity called Sumba fracture, reflecting the boundary between an intra-oceanic character in the west and an arc-continent collision zone in the east as proposed by Audley-Charles (1975) and Nishimura and Suparka (1986). The Sumba fracture occurred during the Late Jurassic, and Sumba drifted northwards away from the continental margin in response to the initiation of the Wharton Basin of the Indian Ocean and performed a clockwise rotation (Audley-Charles, 1975). The discontinuities in geological and geophysical parameters found between Sumbawa and Flores support the existence of Sumba fracture. The prominent offset in the line of volcanism between Sumbawa and Flores might provide the evidence for this structural discontinuity. The geochemistry study observed that the chemical contents in the volcanic products obtained from the islands between Flores and Sumbawa are also different (Nishimura, 1980). Recent geodetic study reveals three possible micro plate blocks (the Lombok-Sumbawa forearc, the Flores-Sumba-Savu and the Timor-Wetar segments) based on GPS velocities that increase relative to SE Asia from 21% to 41% to 63% eastward along the Sunda-Banda arc transition zone (Nugroho et al., 2009). These segmentation boundaries lie along major structural discontinuities in the transition zone, namely Sumba and

Pantar fractures (Audley-Charles, 1975; Nishimura and Suparka, 1986). Interestingly, we also observed that the fast polarisations in the north of Timor, near the proposed location of the Pantar fracture, are aligned parallel to the strike of the Pantar fracture and perpendicular to the principal compressional axis of the strain rate (Bock et al., 2003). Although this fracture is poorly constrained, the geological evidence shows a sharp break in rate of uplift of the coral reefs along the Pantar strait, indicating a zone of fracture (Nishimura and Suparka, 1986). Seismic reflection profiles also reveal fault zones, which might be correlated to this structural discontinuity (Karig et al., 1987). Thus, we suggest that anisotropy around these structural discontinuities is mainly controlled by structural anisotropy.

#### **4. Conclusion**

In this report, we have shown that the average fast directions observed in the Sunda-Banda arc transition zone coincide with the features related to the structural discontinuities as suggested by other studies. In the north-west of Sumba, the pattern of fast directions is consistent to the strike of Sumba fracture separating oceanic character in the west and continental character in the east. In the north of Timor, the pattern of average fast polarizations is consistent to the strike of Pantar fracture. However, further investigation involving the deeper part of the lithosphere is necessary in order to provide a broad-scale understanding of tectonic evolution in this area.

#### **Acknowledgements**

We acknowledge Indonesian Agency for Meteorology, Climatology, and Geophysics (BMKG) and GFZ Potsdam for providing seismogram data used in this research.

#### **References**

- Abdullah, C. I., Rampnoux, J. P., Bellon, H., Maury, R. C., and Soeria-Atmadja, R. (2000). The evolution of Sumba Island (Indonesia) revisited in the light of new data on the geochronology and geochemistry of the magmatic rocks, *Journal of Asian Earth Sciences*, 18, 533–546.
- Audley-Charles, M.G. (1975). The Sumba fracture: a major discontinuity between Eastern and Western Indonesia, *Tectonophysics*, 26, 213-228.
- Bock, Y., Prawirodirdjo, L., Genrich, J. F., Stevens, C. W., McCaffrey, R., Subarya, C., Puntodewo, S. S. O., and Calais, E. (2003). Crustal motion in Indonesia from Global Positioning System measurements, *Journal of Geophysical Research*, 108, 2367.
- Boness, N. L. and Zoback, M. D. (2006). Mapping stress and structurally controlled crustal shear velocity anisotropy in California, *Geology*, 34 (10), 825–828.
- Johnson, J. H., Savage, M. K., and Townend, J. (2011). Distinguishing between stress-induced and structural anisotropy at Mount Ruapehu volcano, New Zealand, *Journal of Geophysical Research: Solid Earth*, 116, 1978-2012.
- Karig, D. E., Barber, A. J., Charlton, T. R., Klemperer, S. E., Hussong, D. M. (1987). Nature and distribution of deformation across the Banda Arc–Australian collision zone at Timor, *Geological Society of America Bulletin*, 93,18–32.
- Lueschen, E., Mueller, C., Kopp, H., Engels, M., Lutz, R., Planert, L., Shulgin, A., and Djajadihardja Y. (2011). Structure, evolution and tectonic activity at the Eastern Sunda forearc, Indonesia, from marine seismic investigations, *Tectonophysics*, 508, 1–4.
- Nishimura, S. (1980). Physical Geology of Indonesian Island Arcs. Kyoto Univ
- Nishimura, S., and Suparka, S. (1986). Tectonic development of East Indonesia, *Journal of Southeast Asian Earth Sciences*, 1,45-57.

- Nugroho, H., Harris, R. A., Amin, W. L., and Bilal, M. (2009). Active plate boundary reorganization in the Banda arc continent collision: insights from new GPS measurements, *Tectonophysics*, 479, 52–65.
- Rutherford, E., Burke, K., and Lytwyn, J. (2001). Tectonic history of Sumba Island, Indonesia, since the Late Cretaceous and its rapid escape into forearc in the Miocene, *Journal of Asian Earth Sciences*, 19, 453– 479.
- Sandwell, D. T., and Smith, W. H. F. (2009). Global marine gravity from retracked Geosat and ERS-1 altimetry: Ridge Segmentation v. spreading rate, *Journal of Geophysical Research*, 114, B01411.
- Savage, M. K., Wessel, A., Teanby, N. A., and Hurst, A. W. (2010). Automatic measurement of shear wave splitting and applications to time varying anisotropy at Mount Ruapehu volcano, New Zealand, *Journal of Geophysical Research*, 115, B12321.
- Shulgin, A., Kopp, H., Mueller, C., Lueschen, E., Planert, L., Engels, M., Flueh, E. R., Krabbenhoft, A., and Djajadihardja, Y. (2009). Sunda–Banda arc transition: Incipient continent–island arc collision (northwest Australia), *Geophysical Research Letter*, 36, L10304.
- Silver, P. and Chan, G. (1991). Shear wave splitting and subcontinental mantle deformation, *Journal of Geophysical Research*, 96, 16,429–16,454.
- Syuhada, S., Hananto, N. D., Abdullah, C. I., Puspito, N. T., Anggono, T., and Yudistira, T. (2016a). Crustal structure along Sunda-Banda Arc Transition Zone from Teleseismic receiver functions. Accepted *Acta Geophysica*
- Syuhada, S., Hananto, N. D., Abdullah, C. I., Puspito, N.T., Anggono, T., Yudistira, T., and Ramdhan, M. (2016b). Crustal Anisotropy along the Sunda-Banda Arc Transition Zone from Shear Wave Splitting Measurements. Submitted *Journal of Geodynamics*.
- Syuhada, S., Hananto, N.D., Abdullah, C.I., Puspito, N.T., Anggono, T., and Yudistira, T. (2016). Study on 2-D Crustal Shear Wave Splitting Tomography along The Sunda-Banda Arc Transition Zone. Accepted *Southeast Asian Conference on Geophysics*
- Teanby, N. A., Kendall, J. M., and van der Baan, M. (2004). Automation of shear-wave splitting measurements using cluster analysis, *Bulletin of the Seismological Society of America*, 94, 453–463.

**Topic:** Disaster Management

**Identification of Area Prone to Multi Hazards using Remotely  
Sensed Data - Case in Lowland Area of Kulon Progo, Yogyakarta,  
Indonesia**

**DisplayText cannot span more than one line!**

*<sup>a</sup>Research Centre for Disaster, Universitas Gadjah Mada, Yogyakarta 55281, Indonesia*

*<sup>b</sup>Faculty of Geography Universitas Gadjah Mada, Yogyakarta 55281, Indonesia*

*<sup>c</sup>Fac. of Math. and Nat. Sciences Universitas Gadjah Mada, Yogyakarta 55281, Indonesia*

---

**Abstract**

This research was carried out in the lowland area of Kulon Progo Regency, Yogyakarta Special Region, Indonesia. It is aimed to identify several natural hazards potential by using Unmanned Aerial Vehicle (UAV) developed by “Kelompok Riset Dirgantara” (Aerospace Research Group) Universitas Gadjah Mada. Visual interpretation was conducted to analyze the landform characteristic related to the specific hazard. Descriptive analysis was carried out by using landform as analysis unit. It is assumed that different landform will reflect different hazard potential and each landform possibly has more than one hazard. Provisional results on image analysis show that lowland area in the research area can be distinguished in to several landforms. Based on the genetic, it can be classified to landform of marine origin and fluvial origin. From the shoreline to the hinterland, landforms can be differentiated such as beach, beach-ridge and swale complexes, alluvial plain, floodplain, and lagoon. Each landform potentially has multiple hazards, for instance earthquake, tsunami, flooding, marine erosion and strong wind. The level of multi hazards is varied for different landform. Further analysis is needed for determining level of risk to multi hazards, i.e. by including vulnerability and capacity factors. By doing so, the results can be used as a disaster risk management basis.

**Keywords**

Multi hazards; UAV; lowland area; landform; risk management

---

**1. Introduction**

Based on the natural condition, Indonesia is prone to multi-hazards event, both geophysical and hydro-meteorological hazards. Almost all natural hazard types can be found in this country, such as earthquake, tsunami, volcanic eruption, landslide, flood, drought, and forest fire. If such hazard affects human life, it will result in disaster. Disaster can occur anytime and anywhere, it may happen either in the urban or rural areas.

---

\* Corresponding author. Tel.: +62-812-271-5091; fax: +62-274-548812.  
*E-mail address:* djati.mardiatno@ugm.ac.id

According to National Disaster Management Authority (BNPB), Yogyakarta Special Region (DIY) area, including Kulon Progo Regency, is categorized at a high susceptibility to disasters. Coastal area as a part of lowland area in Kulon Progo can be called as a quaternary landscape (Santosa, 2014). This area consists of quaternary alluvium dominated by sandy materials. As shown in Figure 1, the coastal area is located between 7°53'18" to 7°59'00" South Latitude and 110°0'00" until 110°14'00" East Longitude. Geographically, this coastal area is situated adjacent to the subduction zone between the India-Australian plate and the Eurasian plate in Indian Ocean. This subduction zone may potentially result in tectonic earthquakes that potentially generating a tsunami.

Tsunami can be caused by the earthquake on the seabed resulting rise in sea waves quickly and suddenly. Although this area in recent years are not directly affected by the tsunami that hit the southern coastal area of Java, there is a tsunami that potentially hit along the south coastal area of Kulon Progo. Last tsunami in 2006 from Pangandaran could reach this location, affected mostly in Temon district.

On the other hand, this lowland area also has been potentially inundated by flooding in the South-East, because the river overflow here sometimes result in a pool of water. This event happened in several districts, such as in Sentolo (caused by overflow of Sungai Papah) and Nanggulan area, due to Keso river overflow (Bappeda DIY, 2007). Water overflowing rivers especially inundated paddy fields.

The variety of potential hazards exist in these areas is very important to be considered as the input in spatial planning (Mardiatno et al, 2016b). Furthermore, this area has been selected as the location of regional mega project such as Fish Port of Tanjung Adikarta, Iron Ore Mining and Processing Plant, and the New Yogyakarta International Airport based on the Regional Regulation No. 1 Year 2012 on Regional Spatial Planning of Kulon Progo Regency Year 2012-2032. Thus, it is necessary to promote the principles of appropriate mitigation as well as disaster risk reduction in case of disaster occur in this area.

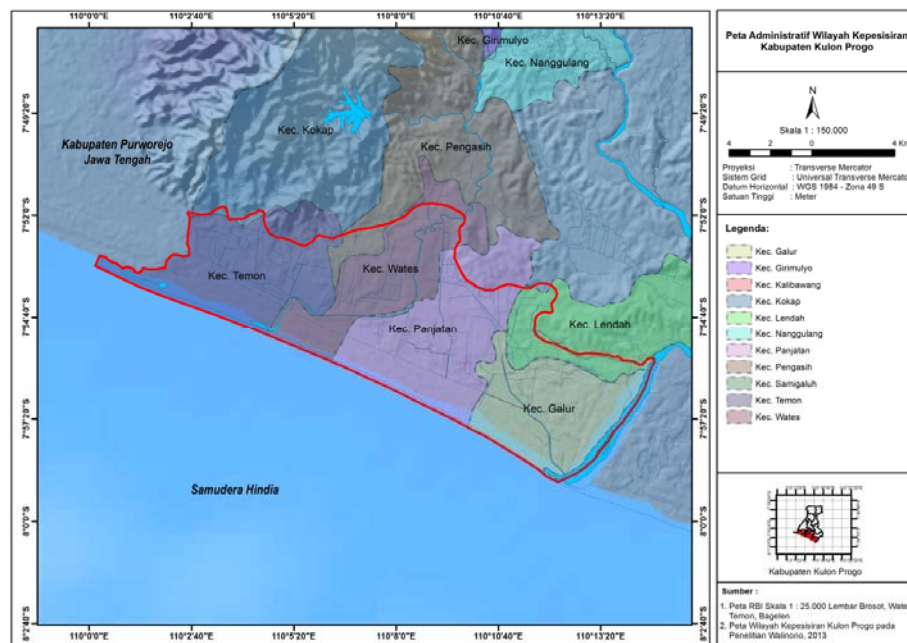

Figure 1. Overview of the lowland area of Kulon Progo

Aerial Photographs by utilizing air vehicle UAV has become a trend and growing in the world of photography. Its use is growing to coastal area and maritime field of study. Data from aerial photographs has become an important data source for further analysis in the maritime world, including for disaster studies. Coastal and maritime information extraction can also be done by optimizing small format aerial photography.

Based on the previous explanation, this research is aimed to identify several natural hazards potential by using Unmanned Aerial Vehicle (UAV) developed by “Kelompok Riset Dirgantara” (Aerospace Research Group) Universitas Gadjah Mada. According to Harintaka (2009) and Mardiatno et al (2016a), the air photo has an advantage in faster data acquisition, cheaper operating costs, and equipment readily available for use of non-metric cameras. Aerial photo has a high spatial resolution, but it has a weakness in geometric distortion, so that it is necessary to correct geometric data prior to use it. The development of vehicle (UAV) and the camera used for capturing photos is also growing rapidly.

## 2. Method

UAV Gama-2 was used as a main instrument for landform data acquisition from the air. The camera installed in UAV for capturing photos is the Single Lens Reflection (SLR) camera with a 35 mm format. The focal length of the lens will be associated with an area of coverage recorded by the camera. The longer the lens, the focal area of coverage will be even greater.

Flight plan determination is one of the processes in taking aerial photographs. Making flight plan should cover the whole of the area to be photographed taking into account both the efficiency and safety of the operator, the tool of UAV and everything that exists in the area of the subject. Several following factors were considered in determining flight plan: end laps and side laps between 60% and 70%, focal length and the sensor for maintaining photo quality, photo scale and fly height, and roaming capability as well as wind direction.

After making a complete flight plan, the next step is setting up the UAV that will be carried out to take aerial photographs. To control the UAV aircraft, supporting equipment were connected to the aircraft. Ground station was put on “Set Home” flight area. One laptop with the Mission Planner (APM Planner) software was utilized for this purpose (Figure 2).

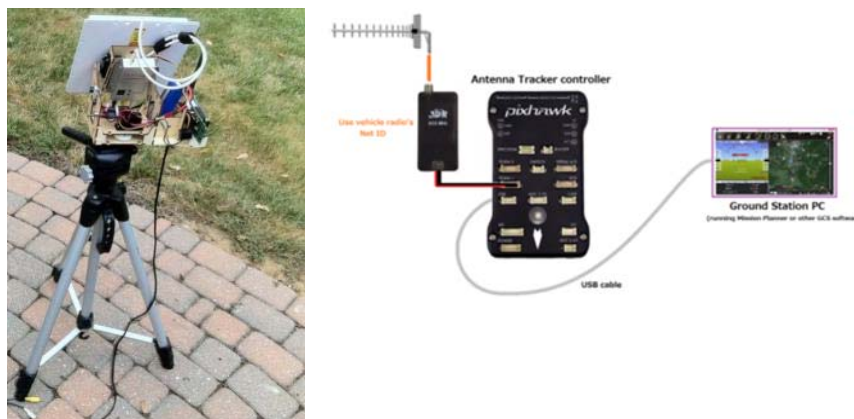

Figure 2. Ground station used for this research

Flight plan was fit to the coverage area, the best roaming capabilities and image resolution that will be generated (see Figure 3). For this research purposes, photo resolution is 5cm/pixel, resulted by the comparison analysis between the sensor capability and 200 meters flying height above ground level.

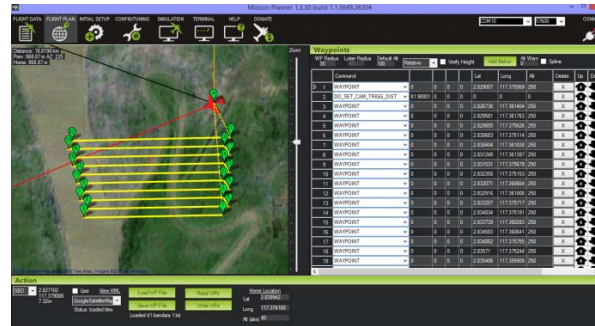

Figure 3. Flight plan illustration

After flight plan was decided, the next step was determining the coverage area to be photographed followed by the flight grid marking and calculating end lap, side lap, flight height, image resolution and camera sensor capabilities. Finally, UAV was flown and captured aerial photographs in accordance with the flight plan decided previously.

Descriptive analysis through photo interpretation was conducted by using landform unit as the analysis unit. To obtain landscape information using aerial photographs, remote sensing imagery interpretation key were applied. Key image interpretation helps to identify objects on aerial photographs. Elements of image interpretation consists of color, hue, shape, size, shadow, websites, associations and patterns. Land use also can be used as an indicator for landform interpretation if morphological features are not easily differentiated. This is a true since landform in the lowland area sometimes express homogenous morphology only.

### 3. Results and Discussions

Aerial photos recorded from camera installed in UAV are 352 photos. Processing of aerial photos into a photo mosaic by doing some of the steps being taken automatically using photogrammetric software. These stages include conversion of photos into a point clouds, followed by simplification the point cloud into a dense cloud (become finer point), and then merge into a mesh cloud dense. After these phases, the next following step was creating mosaics and texturing.

When a collection of photos has presented into a photo mosaic, it is only known coordinates of the model. The model coordinate then was converted into ground coordinates, i.e. data corresponding to the position in the field. For this purpose, rectification by using GCP (Ground Control Point) in the aerial photo is needed. After geometric correction was conducted, images have been corrected properly. The photomosaic can be used for further analysis such as visual identification of objects or features. Figure 4 shows the photomosaic of the research area.

The results of aerial photography using SLR camera produce good images in a good air condition. Several information can be obtained from photomosaic data such as information on beach morphology and morphometry beach. Other useful information is



land use, which might be used for multipurpose analysis, e.g. to support landform interpretation analysis.

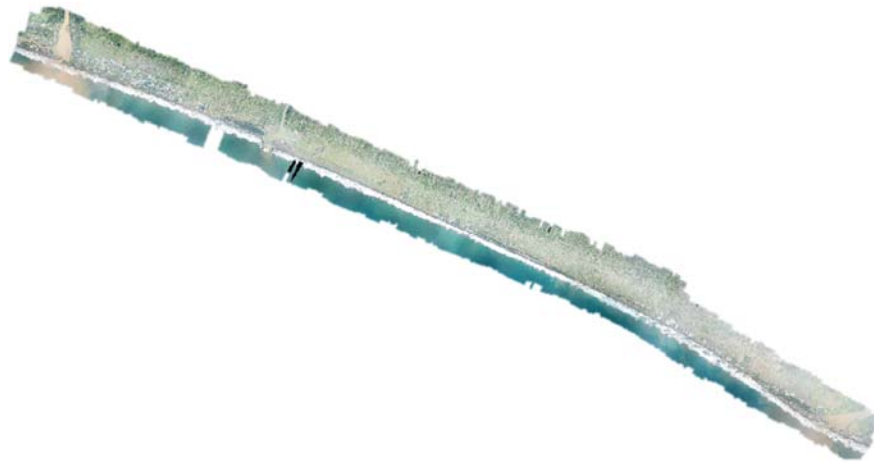

**Figure 4. Photomosaic of the coastal lowland area of Kulon Progo**

Based on the visual interpretation results, landforms in the lowland area genetically can be classified into marine and fluvial origin. They potentially have multiple hazards, either collateral or simultaneous (Mardiatno et al, 2016b). The coastal alluvial plain (or alluvial coastal plain) directly face to the subduction zone in the Indian Ocean. From geomorphology point of view, landscape of the coastal area is located in the two environments, namely the coastal environment with beach ridges-swale complex unit (partly covered by sand dunes) and the coastal environment dominated by beach landforms which has morphological beach cusps.

Mardiatno et al (2015) explained that coastal area is a dynamic system which has an important value as a natural environment. The research area has not only good resources potential but also hazard potential. Coastal area as a strategic location of human activity center and settlement is a prone area to coastal hazards, such as tsunami and marine erosion. Tsunami run up in this region can exceed 10 meters, although the average run up is about 3 meters. The existence of specific features such as mangroves, sand dunes, lagoons, and beach ridges can be used as a protective measures against tsunami threat. Settlements and objects located behind these formations are relatively safe from the tsunami if the run-up height is still below the elevation of these formations.

Potential flood hazard in Kulon Progo is more common in riparian area of Progo, Serang, and Bogowonto River (Bappeda DIY, 2007). Flood events mainly occurred in the floodplain and flood terraces. It can also potentially happen in the alluvial plains and backswamps or marshes located behind beach ridges formation, because runoff may be blocked by beach ridges features. Flooding is usually caused by the overflow of river water at the beginning and middle of the rainy season when rainfall intensity above average or rainfall occurs with a long duration.

The area along the Progo River should be considered as the earthquake source because the river morphology is formed by faulting process. If earthquake happen with its epicenter near the fault zones of Progo River and its magnitude is strong enough, this fault can also be activated as Opak-Oyo pathway in 2006 earthquake, which results in high

level of damages. This tectonic earthquake can be deadly and potentially destroy many buildings or infrastructures that may result in many casualties.

According to the previous explanation, it can be argued that there is a relationship between landforms and potential hazards within the landforms. Landform information is a starting point or key to analyze the hazard potential. Table 1 shows the landform units variation in the research area and their relationship with hazards potential.

Table 1. Landforms and Hazard Potential Types

No	Landform Unit	Hazard Potential
1	Beach ridge-swale complex	Flood, Earthquake
2	Mature Beach Ridge	Tsunami, Earthquake
3	Young Beach Ridge	Tsunami, Storm Surge, Marine erosion
4	Old Beach Ridge	Flood, Earthquake,
5	Alluvial Plain	Flood
6	Coastal Alluvial Plain	Flood
7	Sand Dunes	Tsunami
8	River Basin and terraces	Flood

From aerial photos, it is also possible to identify the detailed morphology. Furthermore, elements at risk as the objects for vulnerability analysis also can be collected. Figure 5 shows the examples of landform features and several elements at risk acquired from aerial photograph data.



Figure 5. Examples of detailed landform features and elements at risk

Land use can also be used for differentiating landform. Since coastal area sometimes reflects quite similar morphology, it is necessary to use other key features, in this case land use. Figure 6 indicates that land use sometimes is very useful to delineate landform from air photos.

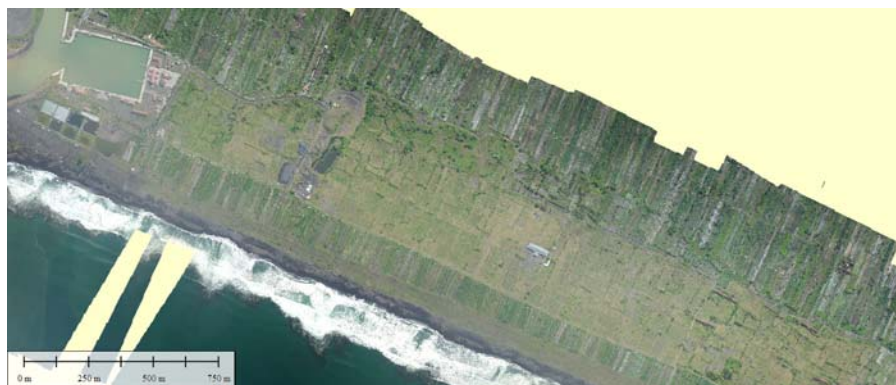

Figure 6. Example of land use as an alternative indicator to differentiate landform

Other features can be acquired for vulnerability analysis. Vulnerability is an important factor for disaster risk analysis purpose. Figure 7 illustrates the element at risk (shrimp ponds) as a vulnerable object to potential coastal hazards such as tsunami and marine erosion.



Figure 7. Example of shrimp pond as a vulnerable object to tsunami and marine erosion

Further analysis is necessary for risk assessment, especially for the analysis related to the realization of new airport in this location (Figure 8). Refer to Paripurno et al (2015), even only for tsunami, risk level in the planned area for airport and its surrounding will increase in line with the rising of element at risk value. The people exposure can be more than 1000 times and total loss will be more than 200 times.

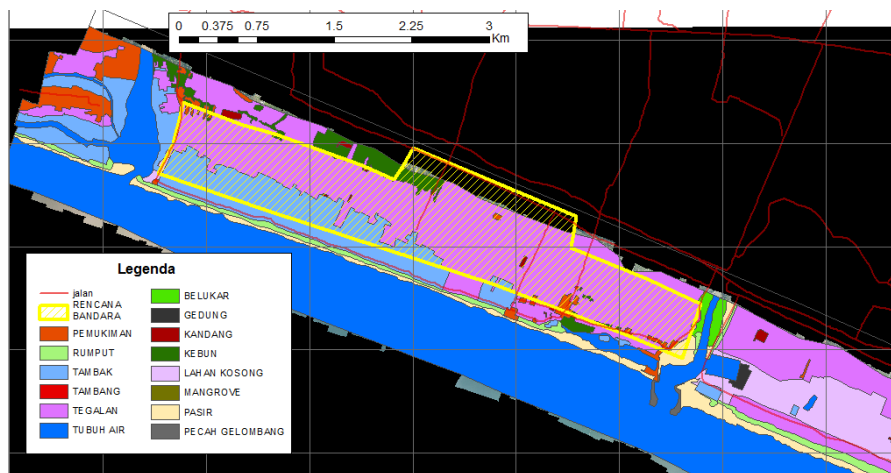

Figure 8. Sketch of the New Yogyakarta International Airport location

Based on the spatial theory, airports, ports and factories is commonly recognized as CBD (Central Business District) that can stimulate the development of other sectors, especially the road network. It has been proven by the government's commitment to JJLS (Southern Roadway) development. JJLS construction is planned for completion in 2019, which is expected to facilitate and stimulate the development of Kulon Progo Regency and surrounding areas. The road network construction is a first step in the regional

development. Road network is an important aspect in developing of an area, where ease of distribution of goods and the mobility of the population is highly influenced the development rate of the region. If there is no right preparation to anticipate the potential multi hazards event in this area, the possibility of loss will be very high.

Disaster risk reduction paradigm is a disaster management planning which integrates scientific and practical view and also considers physical, social, economic, and political factors. It is directed to increase all stakeholder's capability and awareness to manage the multi hazards potential in this region. The implementation of suitable disaster risk reduction efforts in the lowland area must consider the socio-economic factor, local wisdom, environment sustainability, effectivity and efficiency, and also complexity of the area itself.

#### **4. Conclusions**

The research area has potentially multi hazards event, either collateral or simultaneous. Land use can be used as a key features to differentiate landforms as an analysis unit in the lowland area. UAV offers a more detailed spatial terrain data which is very useful for multi hazards analysis. It also provided other useful spatial data to support further analysis such as vulnerability and risk potential. Disaster risk reduction alternatives must take into account the potential multi hazards event and other factors influencing the risk reduction actions.

#### **Acknowledgements**

This paper is part of the research titled "The development of Unmanned Aerial Vehicle-UAV GAMA for Regional Monitoring within the Frame of Maritime State Insight and National Independent" (in Bahasa: *Pengembangan Potensi Teknologi Pesawat Udara Tanpa Awak UAV GAMA untuk Monitoring Wilayah dalam Kerangka Wawasan Negara Maritim dan Kemandirian Bangsa*). The authors thank to the Directorate General of Higher Education Ministry of Research, Technology and Higher Education for the second year (2016) grant of the research and to support this paper writing.

#### **References**

- Bappeda DIY. (2007). Penyusunan Profil (Hazard, Vulnerability, dan Risk), Pemetaan Wilayah Rawan Bencana dan Penyusunan Rencana Aksi, Laporan Akhir, Pemda DI Yogyakarta, Yogyakarta.
- Harintaka (2009). Small Format Aerial Photography dan Small Format Aerial Photogrammetry: Kajian Sistem, Distorsi dan Produknya. In Proceedings of Simposium Nasional Sains Geoinformasi I, Fakultas Geografi UGM, Yogyakarta.
- Mardiatno, D., Sunarto, Rahayu, L., and Malawani, M.N. (2015). Potensi Risiko Bencana Kepesisiran di Wilayah Kabupaten Bantul, Daerah Istimewa Yogyakarta. In Proceedings of Konferensi Nasional Forum Perguruan Tinggi untuk Pengurangan Risiko Bencana (KN FPT-PRB 2015), Surakarta, Indonesia.
- Mardiatno, D., Khakhim, N., and Priyambodo, T.K. (2016a). Identification of Flood-prone Area Using Remotely Sensed Data-Case in Tanjung Selor City, North Kalimantan. In Proceedings of IEEE International Conference on Aerospace Electronics and Remote Sensing Technology (ICARES 2015), Denpasar, Indonesia. DOI 10.1109/ICARES.2015.7429823.
- Mardiatno, D., Susmayadi, I.M., Faizah, M., Mustofa, U., and Ahmad, D.N.A. (2016b). Multi Multi-hazards Analysis Based on Landscape Approach in the Area of Yogyakarta New Airport Site Plan. In Proceedings of the 8<sup>th</sup> International Graduate Students and Scholars' Conference in Indonesia (IGSSCI 2016), Yogyakarta, Indonesia.

- Paripurno, E.T., Nugroho, A.R.B., Wicaksono, A.P., Pradana, G., and Nugroho, N.E. (2015). Kajian Peningkatan Risiko Bencana Tsunami di Pantai Selatan Kulon Progo-Yogyakarta. In Proceedings of Simposium Nasional Mitigasi Bencana Tsunami 2015 (SNMBT 2015), Banda Aceh, Indonesia.
- Santosa, L.W. (2014). Keistimewaan Yogyakarta dari Sudut Pandang Geomorfologi, Gajah Mada University Press, Yogyakarta.

**Topic :** Urban Environment

**ANALYSIS OF STREAM AND RESIDENTIAL AREA PROTECTION  
CASE STUDY: TEMBAGAPURA, PAPUA**

**Toha Saleh\***

*Civil Engineering Department, Universitas Indonesia, Depok 16424, Indonesia*

---

**Abstract**

The problem with residential area such Tembagapura, which close to river that has steep slopes and fluctuated intensity of rainfall, is that flood might occur during rainy season while in the dry season the area is lack of sufficient water supply. This condition and situation normally can be solved by constructing a dam to control the discharge and manage the expected quantity of water. However, the geological condition of the area has also contributes to the flood with large amounts of debris (and sometimes boulders) which carried onto downstream area and caused damage to residential infrastructures. This study is conducted to find suitable approaches to decrease flood velocity which implicates in reducing the peak flood discharge and momentum to transport debris and boulder, as well as give assurance of safe water passage. The analysis is done by iteration in reducing river bed slope to get stable regime, at the same time protect the residential area from excess debris, and normalize the river at selected sections and critical banks. The result suggested installation of series of check dams to trap debris material and use it to build mild bed slope, along with providing sufficient channel capacity to convey at least 50 year flood return period, with additional consideration of using *dolos* and *gabion* to stable the river banks.

**Keywords**

Flood control; stream protection; debris transport; check dam

---

**1. Introduction**

In order to have a sustainable and safe urban area, the local government needs to aware of any possible threat that might occur in the region. Many fast-growing world populations are living in urban areas, and this is only expected to grow more in the coming decades (USAID, 2001). Most of the urban areas are exposed to natural hazards, such as flooding, storms and land-subsidence depend on their location. Urban areas also have a varying degree of vulnerability; depending on the level of development, the coping capacity and the effectiveness of risk reduction strategies that have been implemented.

---

\* Corresponding author. Tel.: +6221-727-0029; fax: +6221-727-0028.  
*E-mail address:* toha@eng.ui.ac.id

Beside flood, in the area which surrounding by steep slopes and has fluctuated intensity of rainfall, the threat could come in the form of debris flow. The debris flows can be triggered by intense rainfall, by dam-break or by land-sliding that may or may not be associated with intense rain. In order to prevent debris flows reaching property and people, a debris basin, such *sabo* dam, may be constructed. Debris basins are designed to protect soil and water resources or to prevent downstream damage. Such constructions are considered to be a last resort because they are expensive to construct and require commitment to annual maintenance (FWS, 2013).

This study gives an example of stream and residential area protection where flood with debris flow often occur in rainy season, together with a strategy to manage safe water passage and obtain sufficient fresh water as city water supply during the dry season.

## 2. Study Area

The study area is the Tembagapura Town which located in Mimika Regency, Papua Province, Indonesia (see figure 1). The town is situated on a high land area by the height between 2000 and 2400 meters above sea level, surrounded by hills and has two main rivers with many streams in the upstream part.

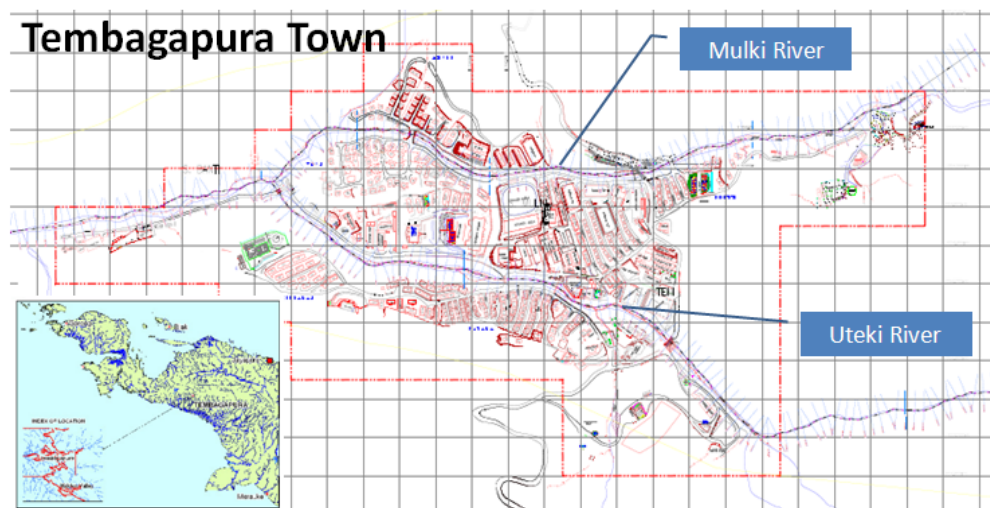

Figure 1. Tembagapura Town Site Area

### 2.1. Hydrological condition

From the rainfall records, Tembagapura has maximum monthly rainfall about 550 mm during September to October, while reached only about 330 mm in June. The range of number of rainy days is between 11 to 30 days throughout the month. The Intensity-Duration-Frequency (IDF) curve from 2013 record is shown in figure 2.

Catchments in Tembagapura are divided into two sub-catchments which surface water flow directly through two rivers, namely Mulki River and Uteki River. Mulki sub-catchment has area about 3.82 km<sup>2</sup> and Uteki sub-catchment has about 7.46 km<sup>2</sup>. Both rivers flow towards western part of the region and merged in downstream area as Banti River (figure 3). Those rivers have a high discharge only in the rainy season while in the

dry season they have a small discharge so that they cannot fulfill fresh water needs for Tembagapura town.

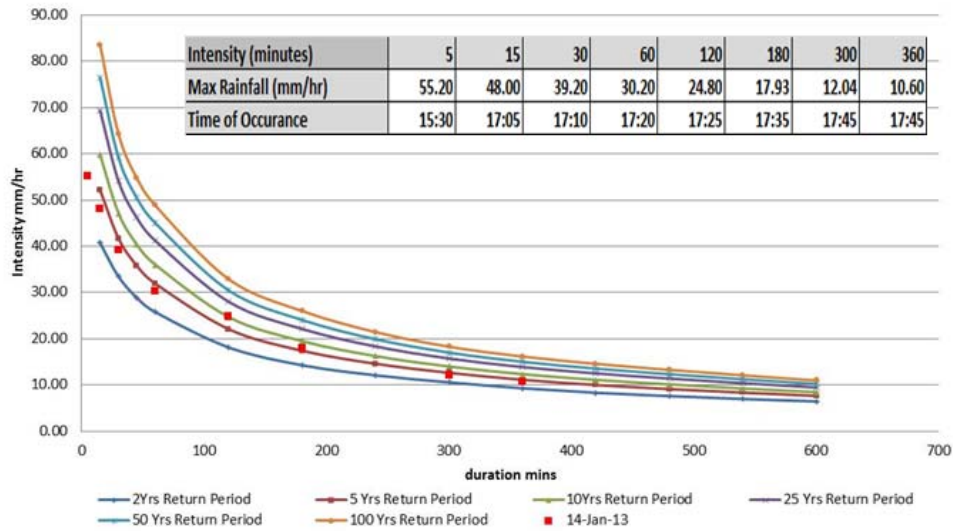

Figure 2. IDF-Curve of Tembagapura (2013 records)

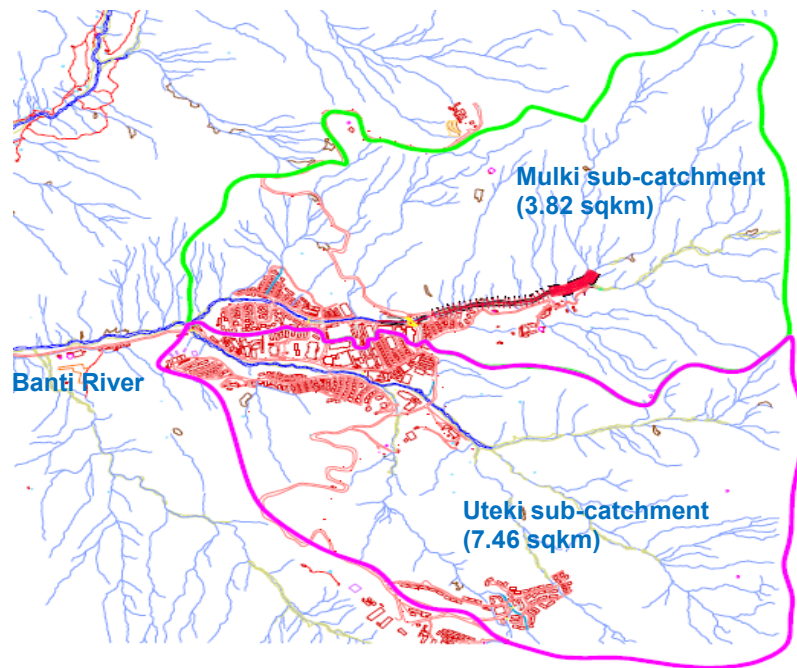

Figure 3. Two main catchment areas of Tembagapura

## 2.2. Geological condition

The geological condition of Tembagapura town site consists of predominantly moderate to complete weathering, red and green mudstone and siltstone inter-bedded with fresh to moderate weathering, red, green and white sandstone and minor conglomerate. These rocks are classified as a part of the Tipuma Formation and Kopai Formation (figure 4) which have metamorphosed.



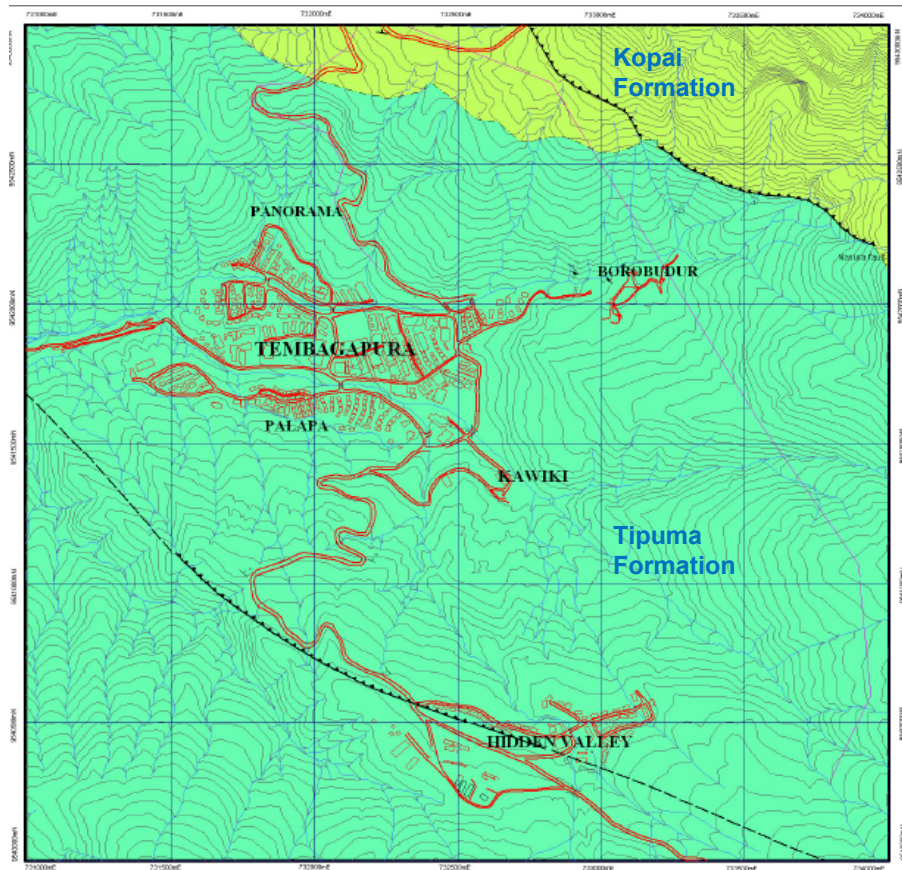

Figure 4. Geological map of Tembagapura site

The Tipuma and Kopai Formations are defined by Visser and Hermes (1962) and have been described in detail by geology investigation. The interpretation of aerial photograph and direct mapping has succeeded in categorizing the slope range and its characteristics as well as the distribution of landslides. The correlation among distribution of landslide and slope range is also shown in table 1 below. It has been identified that the landslides often occur at the slope range between 30% and more than 70%.

Table 1. Slope range and its characteristic

No	Slope Range	Town site (Tembagapura)		Characteristic Terrain Condition	Southern Slope		Northern Slope		Eastern Slope		Tembagapura Slope	
		Area (km <sup>2</sup> )	Percentage (%)		Area (km <sup>2</sup> )	%	Area (km <sup>2</sup> )	%	Area (km <sup>2</sup> )	%	Area (km <sup>2</sup> )	%
1	7 – 15 % (4° – 8°)	0,492	5,455	Sloping	-	-	-	-	-	-	0,38	51,35
2	15 – 30 % (8° – 16°)	0,703	7,795	Moderately Steep	0,03	0,79	-	-	-	-	0,32	43,24
3	30 – 70 % (16° – 35°)	1,882	20,867	Steep	0,87	22,96	0,34	12,83	0,29	26,85	-	-
4	> 70% (> 35°)	5,942	65,883	Very Steep	2,92	76,25	2,31	87,17	0,79	73,15	0,04	5,41
<b>Total</b>		<b>9,019</b>	<b>100</b>		<b>3,79</b>	<b>100</b>	<b>2,65</b>	<b>100</b>	<b>1,08</b>	<b>100</b>	<b>0,74</b>	<b>100</b>

### 3. Methodology

As mentioned earlier that the objective of the study is to find suitable approaches to decrease flood velocity and anticipating the transport debris in the area, as well as give assurance of safe water passage. There are 3 main goals of the analysis with different approach for each purpose. Figure 5 describes the methodology used in the analysis.

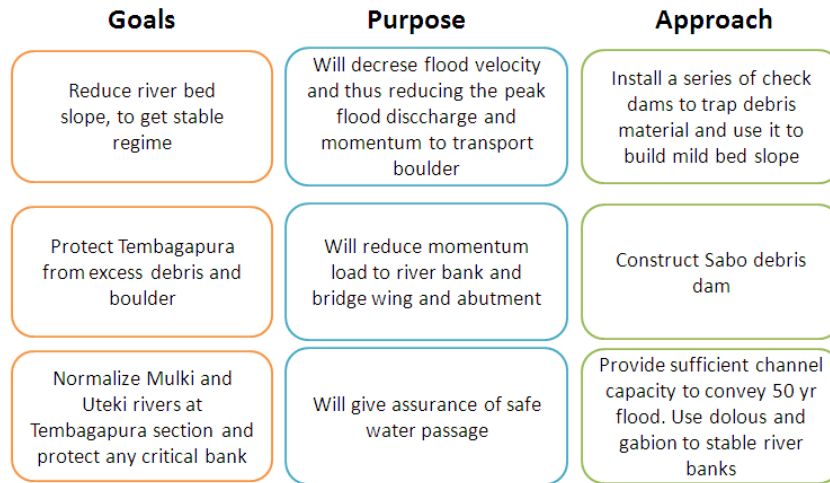

Figure 5. Methodology of the study

For the first purpose, the analysis is done by iteration in reducing river bed slope to get stable regime; this will decrease the flood (water) velocity and lower the peak discharge. Where this can also reduce the momentum to transport boulder brought down the stream during flooding.

The second purpose has strong relation to the first one since the reduced momentum will protect the residential (urban) area from excess debris and boulder. The possible approach would be constructing a debris dam or known as *sabo* dam.

The third purpose will give assurance of safe water passage by normalize those rivers at selected sections and protect any critical banks. To do so, an estimation of 50 years return period of design flood has been set.

### 4. Results and Discussion

#### 4.1. Reducing bed slope for stable regime

The two rivers, Mulki and Uteki, have similar regime and stream characteristics, but the slope in the Mulki catchment has steeper slope than the Uteki catchment. Figure 6 shows the cross-section of each river, where both rivers has slope average more than 20%.

The slope is stabilized using check dams along the cross-sections iteration has been done to obtained proper distance and space. Check dams are constructed across the gully bed to stop channel and lateral erosion. By reducing the original gradient of the gully channel, check dams diminish the velocity of water flow and the erosive power of run-off (FAO, 2009). Run-off during peak flow is conveyed safely by check dams. Temporary check dams, which have a life-span of three to eight years, collect and hold soil and moisture in the bottom of the gully.

To obtain satisfactory results from structural measures, a series of check dams should be constructed for each portion of the gully bed. Because they are less likely to fall, low check dams are more desirable than high ones. Check dams may also be combined with retaining walls parallel to the gully axis in order to prevent the scouring and undermining of the gully banks.

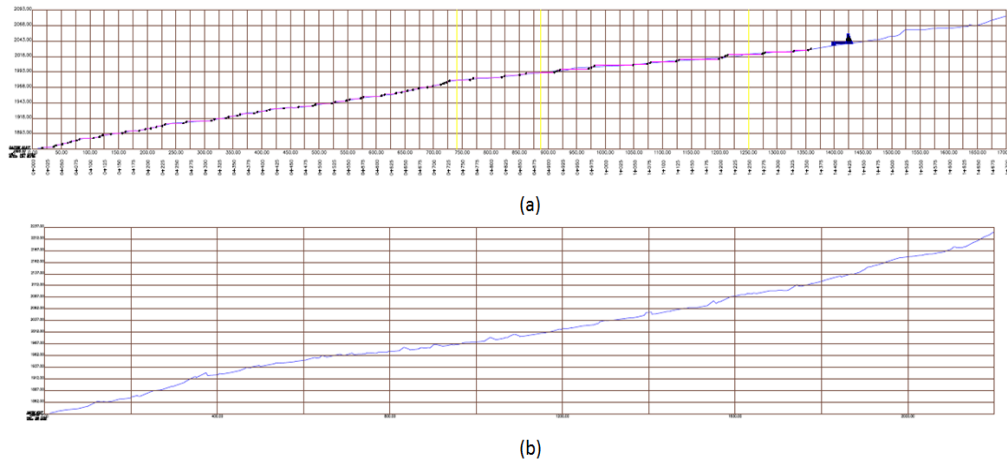

Figure 6. (a) Uteki cross-section, (b) Mulki cross-section

Stabilized watershed slopes are the best assurance for the continued functioning of gully control structures. Therefore, attention must always be given to keeping the gully catchment well vegetated. If this fails, the structural gully control measures will fail as well. Figure 7 shows the typical check dams constructed along the channel.

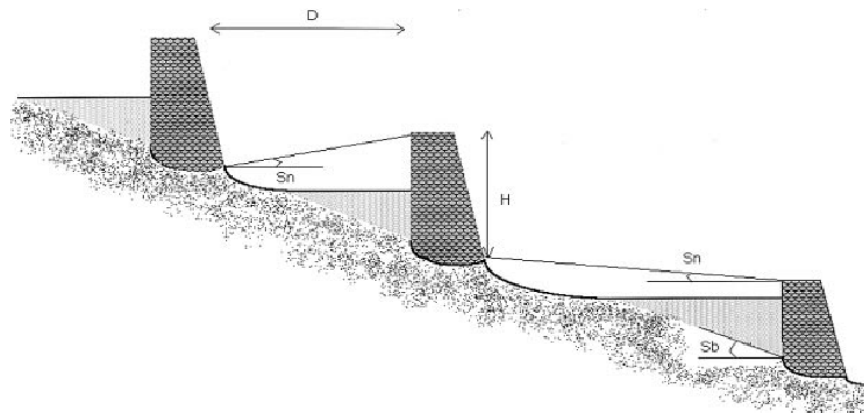

Figure 7. Check dam dimensions in longitudinal section: height ( $H$ ), horizontal distance between two dams ( $D$ ), slope gradient of gully bottom ( $S_b$ ), slope gradient of line connecting spillway and foot of upstream check dam ( $S_n$ ). Between the dams on the left,  $S_n$  has a negative value (reverse slope) (Source: Nyssen, J; 2006)

#### 4.2. Protection against debris flow and boulders

To protect the area against debris flow and boulders, after the regime has been stabled, a Sabo dam will be constructed to capture and hold the debris and boulders. Based on the natural function of Sabo dam, the height of the main dam will bring a result for the stabilization of the river's slope in this specific area where the dam is planned to be built. There will be possibilities where the height obtain from the design will be higher than the existing cliff. Therefore, if it does happen, the height of the main dam will reflect with the height of cliff. Follows are some calculation example to obtain proper dimension of proposed dam.

Geometric properties of the river:

- Baseflow elevation on the downstream of the Sabo Dam River : 2044.5 m
- Elevation of the cliff : 2054.2 m

The slope is determined with this equation below:

$$I_s = \left( \frac{80,9d}{g \cdot 10^2} \right)^{\frac{10}{7}} \left( \frac{B}{nQd} \right)^{\frac{6}{7}} \quad (1)$$

Where:

- $I_s$  = slope of the river
- $d$  = the river bed debris' diameter (m)
- $g$  = acceleration due to gravity (m/s<sup>2</sup>)
- $b$  = the width of the river (m)
- $n$  = Manning coefficient
- $Q_d$  = Discharge of the river (m<sup>3</sup>/s)

Then using equation (1):  $I_s = \left( \frac{80,9 \times 0,04}{9,8 \times 10^2} \right)^{\frac{10}{7}} \left( \frac{10}{0,033 \times 80 \times 0,04} \right)^{\frac{6}{7}} = 0,00089 = 0,089$

Considering the height of the cliff's right side is +2054.24 m, the height of the dam is determined with this equation below:

The height difference of the cliff and the river bed = 2054.24 - 2044.5 = 9.74 m

The dam height must be below from the cliff's height where the dam height is determined to be 6.34 m.

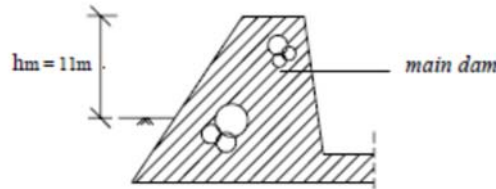

Figure 8. Sketch of the height of Uteki main dam

Main dam's width design:

This equation below is used to determine the width of the main dam

$$B_1 = 0,7 B \quad (2)$$

Where:

- $B$  = the width of the river bed (m) = 10 m
- $B_1$  = the width of the spillway (m)

From the equation (2), the width of the spillway is determined to be 7 m

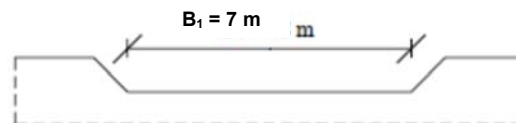

Figure 9. Sketch of the width of Uteki main dam

Spillway height design:

Flow rate which passes through the spillway is quantified by this equation below:

$$Q_d = \left(\frac{2}{15}\right) C_d (2g)^{\frac{1}{2}} (3B_1 + 2B_2) h_w^{\frac{3}{2}} \quad (3)$$

Where:

- $Q_d$  = Discharge of the river
- $C_d$  = Discharge coefficient (0.6 – 0.66)
- $g$  = Acceleration due to gravity = 9.8 m/s<sup>2</sup>
- $B_1$  = the width of the spillway (m) = 7 m
- $B_2$  = the width of the upper spillway (m) = (B<sub>1</sub> + 2m.h<sub>w</sub>)
- $M$  = spillway slope
- $h_w$  = water level (m)

then using equation (3):

$$80 = \left(\frac{2}{15}\right) 0.66 (2.9,8)^{\frac{1}{2}} (3.7 + 2(7 + 2.1 \cdot h_w)) h_w^{\frac{3}{2}}$$

After the equation being executed, there is only one variable undefined which can be determine by using trial and error test. The result shows that B<sub>2</sub> is 12.6 m.

#### Free board design:

The function of the free board is to avoid water to be over-spilled into side of the river. Free board is determined based on the flow-rate of the river. From the calculation, and based on the design rainfall, the free board height is obtained about 0.6 m.

#### Thickness of main dam spillway:

The thickness of the spillway must reflect from the stability and the probability of impact caused by the debris. The thickness is determined to be 4 m.

#### Depth of dam sub-structure:

This equation below is used to determine the depth of the dam structure

$$H_p = (1/3 \text{ s/d } \frac{1}{4}) (h_w + h_m) \quad (4)$$

Where:

- $h_w$  = water level above spillway
- $h_m$  = effective height of the main dam

Therefore from the equation (4) it could have two different value of H<sub>p</sub> which is:

- 1). H<sub>p</sub> = (1/3) (h<sub>w</sub> + h<sub>m</sub>); where H<sub>p</sub> = 3.047 m
- 2). H<sub>p</sub> = (1/4) (h<sub>w</sub> + h<sub>m</sub>); where H<sub>p</sub> = 2.285 m

From the results can be obtained that H<sub>p</sub> value is in range between 2.285 - 3.047 m, where in this design the average value of H<sub>p</sub> is 2.5 m.

#### Slope of the main dam design:

The slope of the main dam is designed for avoiding an intense impact from upstream's debris because it might cause bigger damage into the dam and ignite an abrasion problem in downstream of the dam. Other than that, the slope will give a big influence to the stability of the main dam.

Downstream slope of the dam is based on the material and the critical velocity that passing through the spillway and free falling on the apron floor. The downstream slope is determined with ratio of 1:0.2.

Apron design:

We obtain that the length of the apron is 18.97 m therefore we could even the number and use 21 m as the length of the design.

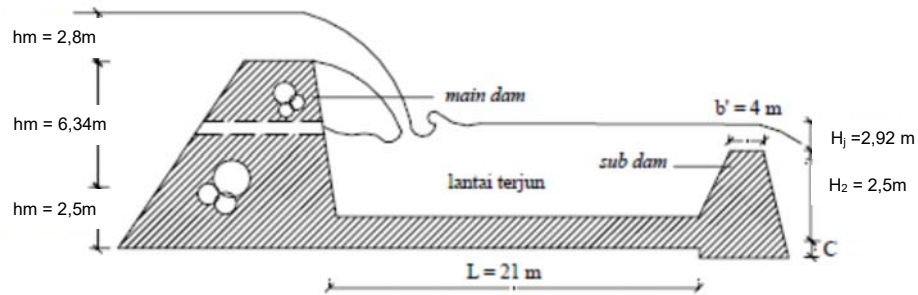

Figure 10. Uteki Dam and Apron Sketch

From overall calculation that has been conducted, the design of Sabo dams of Mulki River and Uteki River are typical. Below are proposed designs for Sabo dam in each river.

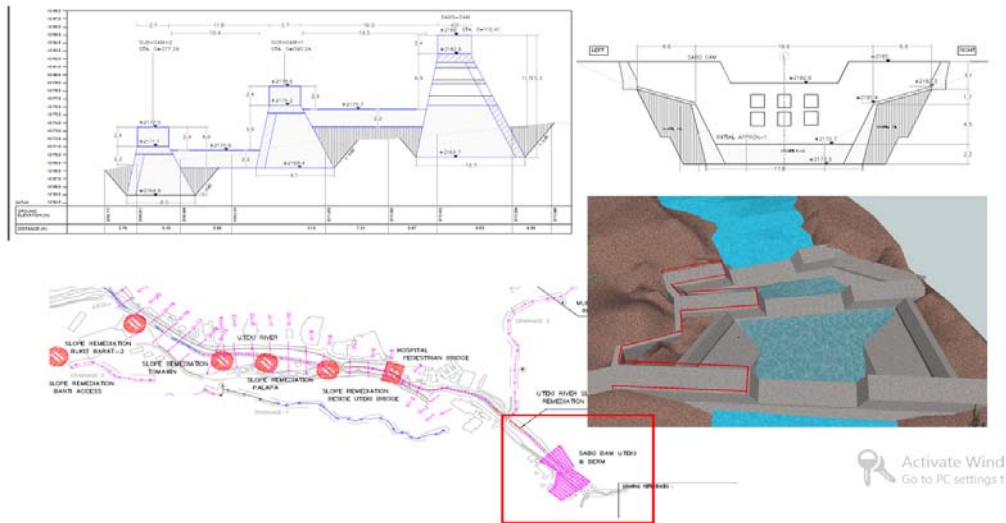

Figure 11. Proposed Sabo dam for Uteki River

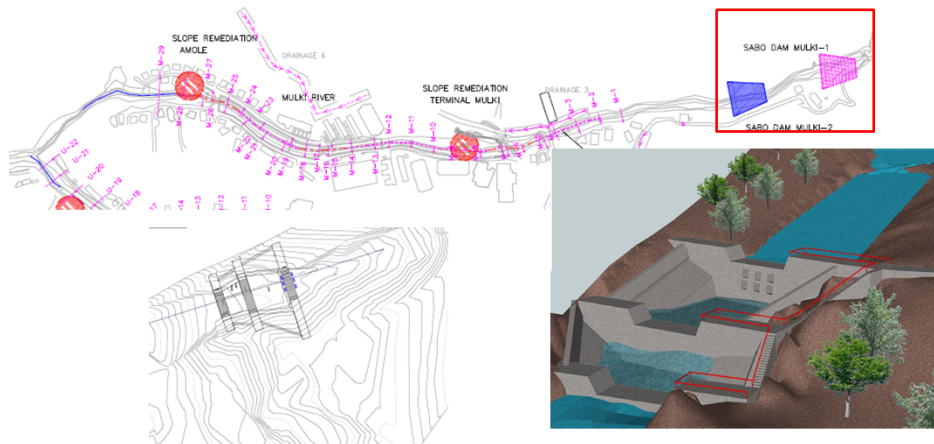

Figure 12. Proposed Sabo dam for Mulki River

### 4.3. River normalization

Normalization of both rivers could be done by removing sediment deposited along the stream, place dolos/coarse materials at the toe of the river bank and the fix eroded areas above to protect surrounding infrastructures (road, bridge and barracks). It is also necessary to remove large boulders in the upstream part which might triggered to be swept away when the peak discharge occurs.

Normalization can be done using existing natural rocks arranged according to the regime (figure 13 a) and in more flat areas, it can be proposed using the vertical gabions along the river side or embankment as shown in figure 13 b.



Figure 13. (a) Normalization using natural rocks, (b) Normalization using vertical gabions

## 5. Conclusion

This study has shown approaches to decrease flood velocity which implicates in reducing the peak flood discharge, reduce the momentum of debris transport, and design normalization of rivers to give assurance of safe water passage.

Reducing river bed slope to get stable regime will have impact to the protection the residential/urban area from excess debris and boulders. Installation of series of check dams to trap debris material and use it to build mild bed slope, along with providing sufficient channel capacity to convey at least 50 year flood return period, with additional consideration of using *dolos* and *gabion* to stable the river banks.

It is also suggested to normalize the river at selected sections and critical banks.

## Acknowledgements

A sincere gratitude to Mr. Soeryantono for the guidance, also to Mr. Achdiana and all supporting team who contributed to this study.

## References

- Knight, D. W., and Samuels, P. G. (Eds) (2003) River Basin Modelling for Flood Risk Mitigation. *Proceedings of an EU Advanced Study Course on River Basin Management*, Birmingham, Oct 2002.
- Nyssen, J. et.al. (2006). The Effectiveness of Loose Rock Check Dams for Gully Control in Tigray, Northern Ethiopia. *Soil Use and Management* 20(1): 55 – 64.

U.S. Fish & Wildlife Service (FWS). (2013). "Debris Basins". Retrieved 30 January 2013

USAID, 2001, Making Cities Work: USAID's Urban Strategy.  
<http://www.makingcitieswork.org/files/docs/MCW/MCWurbanstrategy01.pdf>

Visser, W.A., and Hermes, J.J. (1962). Geological Results of the Exploration for Oil in Netherlands New Guinea; Koninkl. Netherlands Geol. Mijnbouw Genoot., Verh., Geol. Ser., v.20, spec no. 265 p.

[https://en.wikipedia.org/wiki/Debris\\_flow](https://en.wikipedia.org/wiki/Debris_flow)  
<http://www.fao.org/docrep/006/ad082e/AD082e02.htm>



**Topic : Disaster Management**

**Vulnerability of Volcanic Ternate Island: Towards Ecosystem  
Based Disaster Risk Management**

Dyah Rahmawati Hizbaron<sup>a\*</sup>, Estuning Tyas Wulan Mei<sup>a\*</sup>, Arry Retnowati<sup>a\*</sup>, Desy  
Wahyuning Tyas<sup>a\*</sup>, Muh. Aris Marfai<sup>a\*</sup>

<sup>a</sup>*Faculty of Geografi, UGM, Yogyakarta, Indonesia 55281*

<sup>\*</sup>*DREAM Project of Community Resilience and Economic Development Programme, UGM*

---

**Abstract**

Ternate is a volcanic island amongst North Moluccas Island, which belongs to North Maluku Province. It is a volcanic ecosystem island centered on Gamalama Volcano. The island and its inhabitants are prone to volcanic eruption; hence vulnerability studies are essential for this area. This study applied vulnerability assessment using Indonesian Disaster Management Board standard regulation known as Regulation of (Peraturan Kepala) BNPB No. 2/2012 about risk assessment. There are four vulnerabilities assessed namely economic, social, physical/infrastructure, and environment vulnerability. Weighting method is implemented on each vulnerability score, where social vulnerability considered as the highest weighting factor. Environment vulnerability is the lowest weighting factor in consideration that environment suffered less compare to other element at risk. Based on the calculation, the highest vulnerability is in the urban area while the rural area less vulnerable. As volcanic ecosystem based island, Ternate inhabitants depend on their ecosystem services to support their livelihood. Therefore, this study argued and proposed to apply ecosystem based disaster risk management upon Ternate as volcanic island to minimize its vulnerability.

**Keywords**

*Ternate; volcano; vulnerability; ecosystem; Ternate; Indonesia*

---

**1. Ternate island and its volcano**

Ternate island is located administratively in North Maluku Province, Indonesia. Its island is formed by Gamalama volcano activities and lied above a low angle subduction zone of Sangir and Halmahera arc (Hamilton, USGS Prof. Paper., 1979) (see Figure1). The activity of plate tectonic surrounding North Maluku islands, including Ternate, triggers earthquake occurrences and volcano eruption when Gamalama is in the active level (Hendrayana, et al. 1996).

Ternate inhabitants' activities mostly rely on the natural resources nurtured by volcanic materials. The island was well known as the spices island during Dutch government colonialism in the 1800s - 1900s. The spices trail still can be found, particularly in the northeast to northwest of the island. Agriculture activities rely basically on the volcanic ecosystem of Gamalama. After the 2011 eruption and lahars

---

<sup>\*</sup> Corresponding author. Tel.: + +62 81931 445980, fax: +62-274-6492340  
*E-mail address:* dyah.hizbaron@ugm.ac.id

floods, sand and gravel mining occur in several river outlets. Due to its historical background as center of spices trade, Ternate Island contributes to the development of North Mollucas island in term of distribution of goods and services to Sofifi, the capital city.

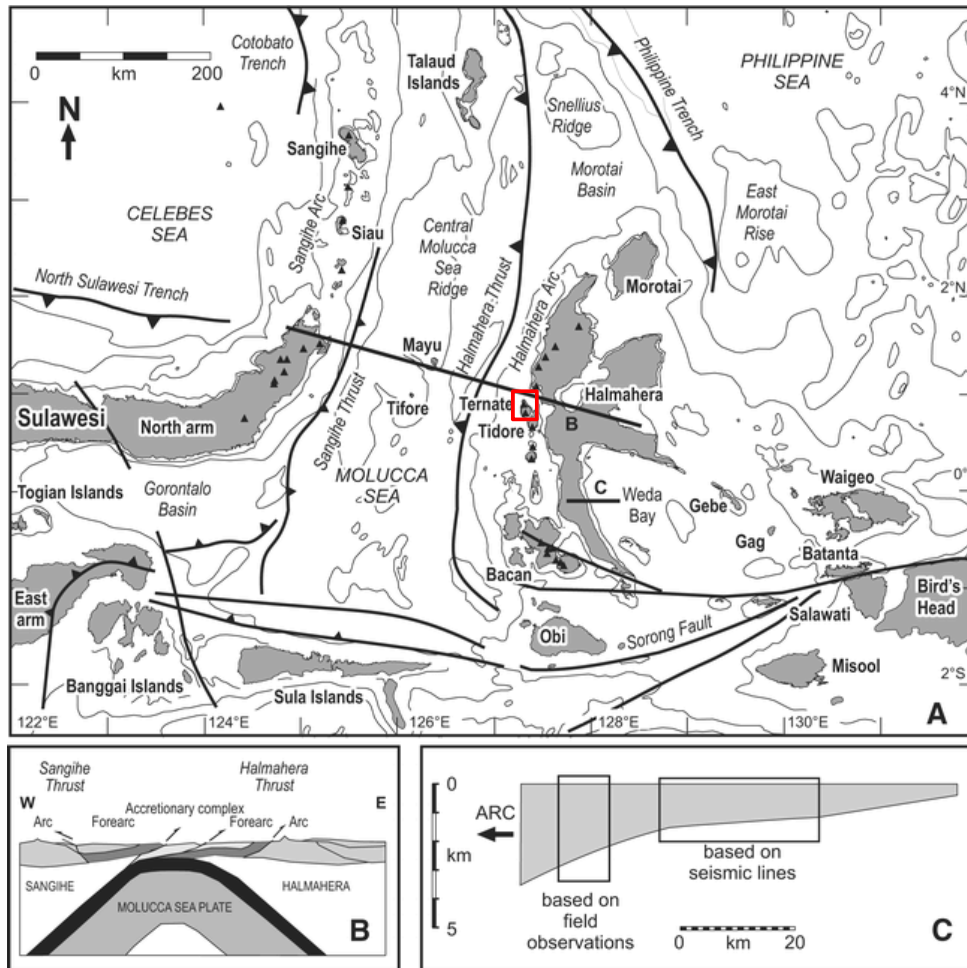

Figure 1. Ternate Island (see red square) and its surrounding tectonic plate

Gamalama volcano is one of five volcanoes in North Maluku Province, which is still in active phase. The last eruption was in 2015 and shut down local airport for several days due to its volcanic ashes. Transportation accessibility in Ternate rely not only on air transportation, it also make use sea transportation as secondary option (Ternate Spatial Plan, 2012-2032). There are at least three main ports in Ternate which support the inhabitants' and visitors mobile accessibility when the air transportation close due to Gamalama eruption.

Ternate Island is basically the volcano itself. Gamalama eruption in 1980s once forced inhabitants in the north part area to evacuate to closest island namely Tidore and Hiri Island. Since then, there was no adequate record of eruption that imposed people to leave their village and the main island.

This study aims to analyze vulnerability of the island towards volcanic eruption. The method proposed highlights Indonesian National Disaster Management Board on vulnerability assessment *Perka BNPB no. 2/2012*, which applied analytic hierarchy process (AHP). In more details, this study targeted ecosystem based disaster risk reduction application to minimize vulnerability in the area.

## 2. Hazard and vulnerability of Ternate Island

### 2.1. Volcanic Hazard of Gamalama

Ternate island is one of insular isles in North Maluku Province which prone to volcanic eruption and lahars, earthquake, and coastal hazard. The island has two different characteristics, due to physical features and social economic characteristics, namely northeast to northwest part of the island that shows rural activities, and the southeast that more urbanized area. Based on the hazard zone map published by the volcanology agency (Baharudin, 1996), the rural area is prone to volcanic eruption rather than the urban area. Hazard zone map of Ternate Island due to Gamalama eruption is published by Indonesian Center for Volcanology and Geological Hazard Mitigation (CVGHM) can be seen in Figure 2. Based on Disaster Management Board regulation *Perka BNPB no. 2/2012*, Ternate Island 3<sup>rd</sup> hazard zone is scored 1; 2<sup>nd</sup> hazard zone score 0.66; and 1<sup>st</sup> hazard zone score 0.33. The value of each score is based on its potential damage.

Landscape of the northwest part of Ternate Island is steeper than the northwest to southeast part where central business activities take place and grow in the lower area. The volcanic risk becomes the first concern in the research because in 2012, CVGHM stated that all of volcanoes in North Maluku, except Kie Besi Volcano, were on active level. One of the active volcanoes was Gamalama Volcano (1,715 m, located in Ternate Island, the most densely populated district in North Maluku – more than 200,000 inhabitants in 111,39 km<sup>2</sup>). They are relations between volcanic phenomenon and elements at risk (Bignami, et al., 2012).

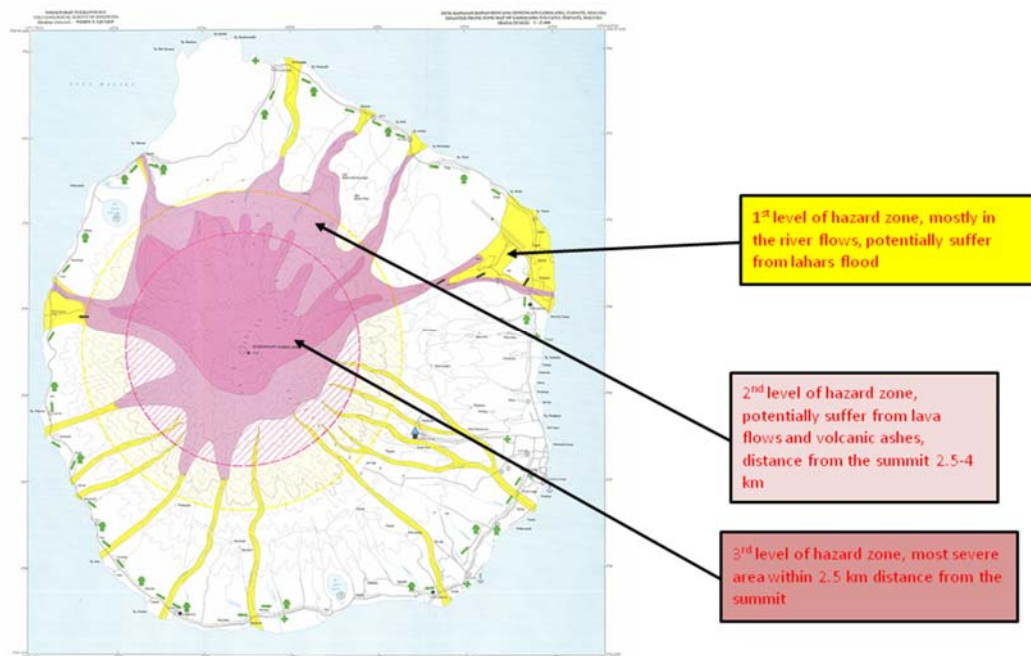

Figure 2 Ternate island hazard zone (see the different color of each zone)

### 2.2. Vulnerability of Ternate island

The volcanic hazards are the cause of major negative impacts on the ecology, natural resources degradation, infrastructure damage, and they also impacted agricultural activities (Hadmoko et al, 2010). The rural people of Ternate island through

generations has developed on local knowledge to "read the sign" of Gamalama activities with volcanic ash as the main hazard. However, in 2011 eruption, local people and the government experienced the lahars flood as secondary hazard and become disaster when victims recorded that time.

This study apply vulnerability parameters based on Head of BNPB regulation number 2 issued in 2012 about risk assessment with some adjustment due to Ternate island characteristic. There are economic, social, physic, and environment vulnerability which then weighted to get vulnerability index in total (see Figure 3). Each component consists of several indicators, for example social vulnerability consist of population density and social awareness. Some indicators need to be adjusted to data availability. The calculation is based on scoring and weighting factors for each vulnerability indicators.

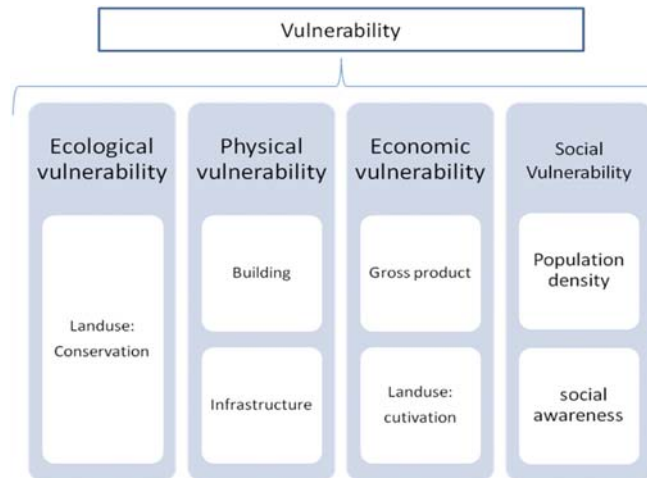

Figure 3 Total vulnerability components (Perka BNPB no. 2/2012)

### 2.2.1. Economic vulnerability

This study adjusted the economic vulnerability assessment using three parameters, namely width of productive land (cultivation), gross product value, and the lost of livestock. Livestock is considered important to be valued due to number of farmers potentially suffered from the lost of cattle and poultry. These rural activities mostly occur in the northern part of the island, whilst in the southern part, economic activities mostly dominated by trade and services as urban area. As consequence, the scoring and weighting calculation result shows that the rural area, Pulau Ternate sub-district economic vulnerability is the lowest. Ternate Utara sub-district, where the airport located at, is high vulnerable economically. Figure 4 shows economic vulnerability of Ternate Island.

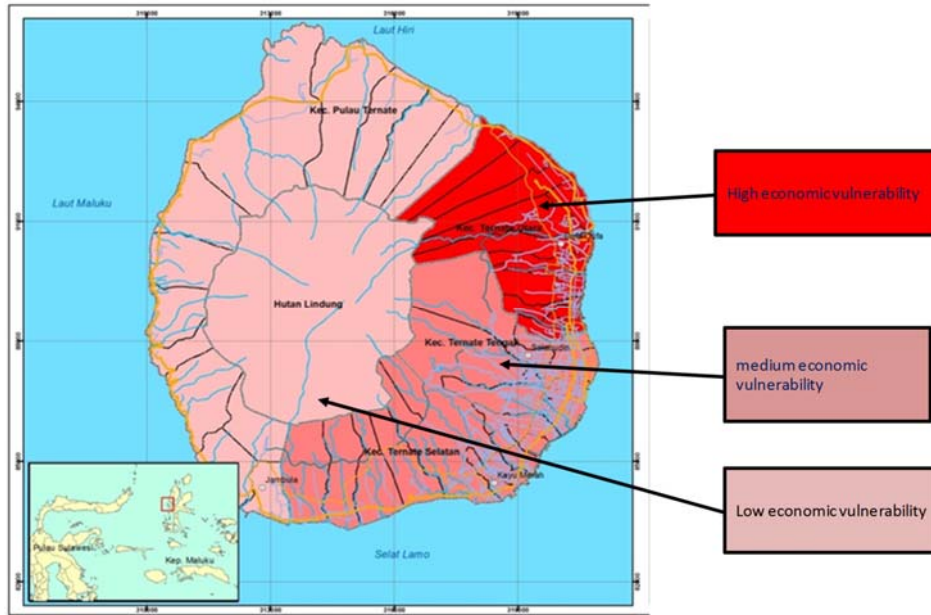

Figure 4. Economic vulnerability of Ternate island

### 2.2.2. Social Vulnerability

Social vulnerability components in this study basically is demographic factors, there are population density, sex ratio, and age ratio. No recoded data available for poverty and disabled people from Ternate statistic data (Ternate in figure 2014). Center business of Ternate Island, located in Ternate Tengah sub-district, is in high social vulnerability.

### 2.2.3. Physical vulnerability

There are four parameters applied to assess the physical vulnerability in this study, namely building density, public and vital utilities, and industry facilities. When eruption occur, it is possible some facilities and infrastructure collapse or disrupted. Most of facilities and infrastructure are located in the most dense population and economic activities, namely Ternate Tengah sub-district. Hence, this area is physically high vulnerable. Lowest physical vulnerability is located in Pulau Ternate sub-district, the rural area of the island.

### 2.2.4. Environmental vulnerability

Main parameters of environmental vulnerability in this study are conservation and buffer zone. The forest in the Gamalama summit is most prone to eruption. Surrounding the forest, some spices plants such as cloves, nutmeg, and pepper cultivated there. These spices plants are at risk and possibly disrupted the inhabitants' livelihood. Ternate Selatan sub-district is at high environmental vulnerability based on the conservation area, namely mangrove and shrubs. Pulau Ternate sub-district as rural area is at medium environmental vulnerability. Ternate Tengah and Ternate Utara sub-district, which are urban area, are classified at low environmental vulnerability. Figure 5 shows Ternate island environmental vulnerability.

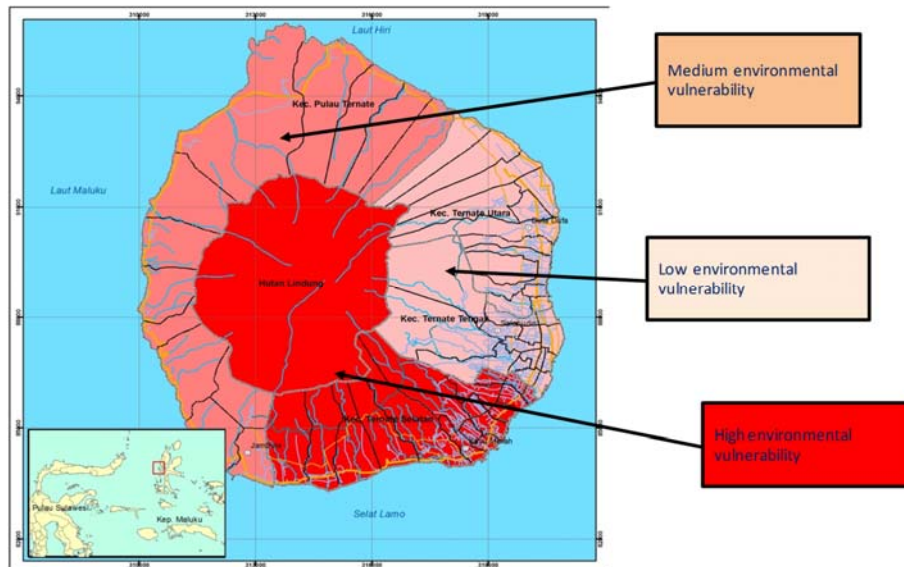

Figure 5. Environmental Vulnerability of Ternate island

#### 2.2.4. Total index of vulnerability

Total index vulnerability is the result of each vulnerability score and weighting. weighting factor for social vulnerability is the highest (40%) amongst economy and physical vulnerability (each 25%), and 10% for environmental vulnerability. The environmental vulnerability-weighting factor is small percentage in consideration that no social community activities disrupted directly from the environment. This study argues the environmental vulnerability consideration (10% weighting factor). However, based on the BNPB regulation, total index vulnerability of Ternate island shows that Ternate Selatan and Ternate Tengah sub-district, located in the urban area (southeast part of the island), are most vulnerable compare to other sub-districts (see Figure 6). Managing the vulnerability of Ternate island need specific intention and integration due to its volcanic characteristic. Vulnerability integration into spatial plan has been initiated in Indonesia (Hizbaron, et.al., 2012).

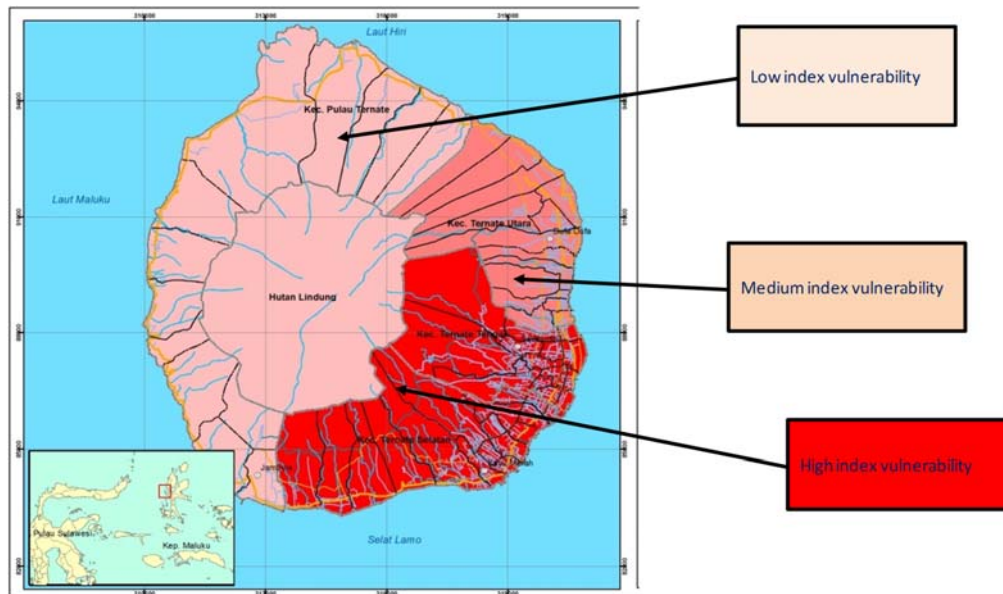

Figure 6. Environmental Vulnerability of Ternate island

### 3. Ecosystem based disaster risk management

This study proposes to consider ecosystems approach for disaster risk management (Renaud, et.al 2013) in the volcanic ecosystem Ternate Island. The island is the volcano body itself; therefore the ecosystem services (MEA, 2005) need to be considered as the weighting factor in calculating the island vulnerability. Unfortunately, the ecosystem services have not yet calculated thoroughly. The Ternate Island itself indicated intensive interaction between the people and their environment. People receive benefit from the nature, in this study, Gamalama provide materials for agriculture and determine people behavior on managing the resources.

Vulnerability maps assessed using BNPB regulation show that the urbanize area, where human often modify the ecosystem, have high vulnerability index. Modified ecosystem in the urban area for certain provisioning services, lead to the declining of other services. Unregulated settlement along the river has caused victims and losses during 2011 lahars floods. On the other hand, the rural area in the northern part of the island shows low index vulnerability. However, need to keep in mind that spices plants on the surrounding conservation (forest) area determine the livelihood of the rural people. Such damage due to volcanic eruption will lead to decreasing economic services of rural people. They are more affected by the loss of ecosystem services because their live depend mostly to agriculture.

Regulating services are critical for ensuring the reliable supply of other ecosystem services, as well as helping reduce people's exposure to volcanic hazards. The northern part of Ternate island play as the regulating service area for southern part. The declining of regulating ecosystem services in one side will lead to disruption of other services. Exposure to volcanic hazard will increase when northern part of the island, which is the most affected area of Gamalama eruption (3<sup>rd</sup> hazard zone), modified for certain services.

Ecosystem services shape both the exposure of people to hazards and the ability of people to cope with hazards. The rural ecosystem in northern part of the island shows resilience pattern, but should not only relying to the natural ecosystem. Policy makers need to comprehensively include ecosystem services trade-off between rural ecosystem and urban ecosystem on Ternate Island. Short-term demand on urbanize area of Ternate

Island will give longer term impact, demands on different scale provision of ecosystem services. Hazard regulating services and vulnerability indicators depicted from ecosystem services of specific characteristics, namely small island with active volcano like Ternate, need to be considered into the risk assessment regulation by authorized government institution. Ternate Island disaster risk management need to integrate the ecosystem services with the regulating services, in this study volcanic hazard of Gamalama and its natural resources.

#### 4. Conclusion

The vulnerability assessment which is part of risk assessment based on Indonesian Disaster National Management Board namely *Perka BNPB 2/2012* consider the environment parameter has indirect impact to social life of people. The study indicated that vulnerability assessment reveals which area needs to be prioritize within disaster risk management. Instead of relying upon formal action from the government, the idea of the research is to introduce a slightly different idea to implement disaster risk reduction. There are so many methods and approach to conduct disaster management, i.e. Participatory based DRR, Top down based DRR, and the most challenging is Ecosystem based DRR. The ecosystem plays important role from the global to local services provision. Environment services correlate to social economy life of the people. It then creates social engineering, which being effectively implemented on the daily basis. In addition, such specific characteristics of environment, volcanic environment of Ternate Island in this study, determine the inhabitant livelihood and other social activities supporting them. The vulnerability assessment, then need to consider the environment services.

#### Acknowledgements

This study is part of Community Resilience and Economic Development (CaRED) programme, the collaboration between Universitas Gadjah Mada Yogyakarta and Ministry of Foreign Affairs and Trade (MFAT) aid programme New Zealand.

#### References

- Hadmoko D.S., Lavigne F., Sartohadi J., and Hadi M.P., Winaryo. (2010). Landslide hazard and risk assessment and their application in risk management and landuse planning in eastern flank of Menoreh Mountains, Yogyakarta Province, Indonesia. *Natural Hazards*. DOI 10.1007/s11069-009-9490-0. Vol. 54, no3, pp. 623-642.
- Hamilton, USGS Prof. Paper., 1979.
- Hendrayana, L., Surono, and Handayani, G. (1996). A Short note on: Basic Behavior of the Mount Gamalama's Eruption. *JMS*, vol.1 no.2, pp. 1-14.
- Hizbaron, D.R., Baiquni, M., Sartohadi, J., and Rijanta, R. (2012). Urban Vulnerability in Bantul District, Indonesia - Towards Safer and Sustainable Development. Article in *Journal: Sustainability*, vol.4, pp. 2022-2037.
- Indonesia Disaster Management Board (BNPB). (2012). Head of BNPB Risk Assessment Regulation number 2.
- Bignami, C., Bosi, V., Costantini, L., Cristiani, C., Lavigne, F., Thierry, P. (2012). *Handbook for Volcanic Risk Management : Prevention, Crisis Management, Resilience*. MIAVITA team, Orleans, France.
- Millennium Ecosystem Assessment (MEA). (2005). *Ecosystems and Human Well-being: Synthesis*. Island Press, Washington, DC.



- Regional Planning and Development Board of Ternate Municipality. (2012). Spatial Plan of Ternate Municipality 2012-2032.
- Renaud, F. G., K. Sudmeier-Rieux, And M. Estrella. (Eds) (2013): The Role of Ecosystems in Disaster Risk Reduction. UNU-Press, Tokyo.
- Syiko, S.F., Ayu, T.R, and Yudono, A. (2013). Evacuation route planning in Mount Gamalama, Ternate Island - Indonesia. *Procedia Environmental Science* 17 (2013) pp. 344-353.

---

## **Study of 6-module X-band array antenna for Airborne CP-SAR application**

Kaihei Nakamura\* , Josaphat Tetuko Sri Sumantyo , Cahya Edi Santosa , Asif  
Awaludin †

*Center for Environment Remote Sensing (CEReS), Chiba University, Japan*

---

### **Abstract**

The synthetic aperture radar (SAR) is a kind of active sensors. To acquire the images of target in remote area, the SAR uses microwave signal. Nowadays, Josaphat microwave remote sensing laboratory (JMRS�), Chiba university, Japan is developing the Boeing 737-200 on-board X-band airborne SAR system. As the system requirements of proposed X-band SAR, the wide bandwidth of transmit signal, narrow beam width, beam tilting, and circular polarization are needed to support the high resolution image in range and azimuth directions. The frequency resource is set to the center frequency on 9.4 GHz and the bandwidth of 800 MHz. Also, the antenna should support the tilt angle up to 35 degree. To realize these requirements, the array antenna which has same characteristic in each module is proposed in the paper. The proposed antenna has 6 modules and each module is designed as 2 by 6 elements. Considering the combination of these modules, the characteristic of each module is preferred to have same value because of used technic to tilt transmitted signal. The performance of proposed antenna has been verified based on the four performance evaluation parameters; return loss, axial ratio, gain, and radiation pattern. As a result, S11, gain and radiation pattern could acquire the almost same value. However, in axial ratio, there were some difference between each module. As a reason, the interference of transmitted signal is considered because of sequential array in object to be measured.

### **Keywords**

Synthetic aperture radar; circular polarization; airborne SAR; X-band antenna;  
(Include approximately 5 keywords)

---

## **1. INTRODUCTION**

Recently, the circularly polarized (CP) antennas are attracting much attention in remote sensing fields. The benefits of CP antenna compared to the conventional linearly polarized (LP) antenna are listed as follow; small resistant than LP antenna while transmitted in atmosphere, less phase variation when the radiated wave through ionosphere and ease of antenna making which has narrow beam width than linear

---

\* Corresponding author. Tel.: +81-43-290-3846.  
E-mail address: Kaihei-hey@chiba-u.jp

polarization antenna. These characteristics have advantages on the energy efficiency issue and the ease of synthetic aperture processing in radar application. Due to these advantages, the design of CP antenna for synthetic aperture radar (SAR) has been proposed in this paper. SAR is a kind of active sensors that using microwave signal.

SAR is a kind of an active sensor. In the SAR image processing mechanism, the larger size antenna offers the high resolution images of target. Linear polarization (LP) was used as conventional antenna, however this paper proposes about the circularly polarized (CP) antenna for SAR mission. CP antenna has advantages on the narrow 3-dB bandwidth, higher resolution, and etc. Therefore, we designed CP antenna which has the narrow beam width and wide bandwidth. Proposed antenna will be implemented Boeing 737-200 platform. The requirements of airborne SAR mission is summarized in table.1. To meet the ends of requirements, the array antenna with 2 x 16 elements was used. It is planned to use by combining as array antenna with 16x16 elements. In this experiment, 6 modules that were developed for performance test will be measured. And, they will be checked whether they meet the demand or not and there are variations in the performance or not.

## 2. ANTENNA REQUIREMENT

Table 1. Requirement of antenna in on-board SAR mission

Categories	Specification
Platform	Boeing737-200
Altitude	Max. 35,000 feet / 10,668 m
<b>Radome dimension</b>	
Width	508.66 cm
Depth	38.10 cm
Height	50.80 cm
<b>Signal properties</b>	
Center frequency	9.4GHz
Bandwidth	800MHz
Antenna polarization	circular polarization
Beam width	horizontal : under -13dB vertical : under -15dB
Beam direction	horizontal : 0 degree vertical : 35 degree
Axial ratio	under 3dB

Table 1 shows the requirements of antenna property. As the radome sized is fixed, antenna should be designed according to the maximum size of radome. Center frequency is 9.4 GHz (X-band) and antenna should support the bandwidth of 800 MHz. Antenna is designed to circularly polarized which means that the axial ratio within the required bandwidth should be designed under 3 dB. Also, as the SAR transmits its beam perpendicular to the flight path but little bit tilted downward, the center of beam radiation should be shifted 35 degree from 0 degree.

### 3. ANTENNA MEASUREMENT

The proposed antenna performance was measured in anechoic chamber of JMRSI. We used the vector network analyzer (VNA), turn table which is set in distance of antenna, the turn table controller, and PC. The measurement concept is depicted in Fig. 1.

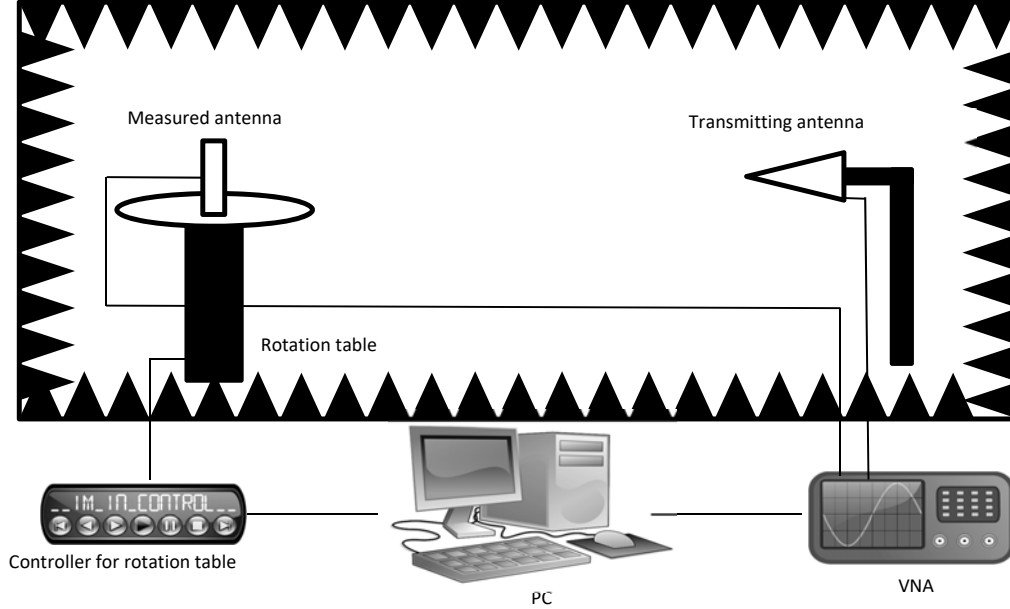

Figure 1. measurement concept

The measured antenna is installed on turn table, and it is possible to measure the circumference of the antenna by rotating turn table. Also, the purpose of this measurement is to measure far-field condition. The far-field of antenna is expressed by equation

$$d_f \geq 2D^2 / \lambda, \quad (1)$$

where  $D$  and  $\lambda$  are the largest dimension of the radiator (or the diameter of the antenna) and wavelength, respectively. In this time, the distance of far-field is more than about 5.9m because the largest dimension of measured antenna is 30cm. in addition, equipped VNA can get only result of S11 and radiation pattern. To obtain the result of axial ratio and gain, the data must be calculated by computer using software.

Axial ratio is the ratio of major axis and minor axis in ellipse polarization. Namely, axial ratio can express by equation

$$|R| = \frac{\text{major axis}}{\text{minor axis}} \geq 1. \quad (2)$$

After rewriting to the measured data, equation can be written as

$$|R| = \frac{E_{max}}{E_{min}}. \quad (3)$$

If we assume that the data measured by right handed circular polarization is  $P_R$  and the data measured by left handed circular polarization is  $P_L$ , relational expression is expressed as  $E_{max} = P_L + P_R$ ,  $E_{min} = P_L - P_R$ . Therefore, axial ratio is calculated by

$$|R| = \frac{P_L + P_R}{P_L - P_R}. \quad (4)$$

For the gain, the result is calculated from equation

$$G = 1.64 \frac{P_{ant}}{P_{dipole}}. \quad (5)$$

where  $P_{ant}$  is received power of measured antenna,  $P_{dipole}$  is received power of dipole antenna that is used as criterion instead of isotropic antenna.

#### 4. ANALYSYS AND RESULT

In antenna performance analysis, the 6-moule of same designed antenna were tested in anechoic chamber. In the future, these modules will be combined as array, however we separate each module to measure the profile of single module in this time. Therefore, each module has to show same characteristics. In this chapter, S11 (return loss), axial ratio, radiation pattern, and antenna gain were measured. Also we examined the error from identical design parameters. The S11 result of each module is shown in fig. 2.

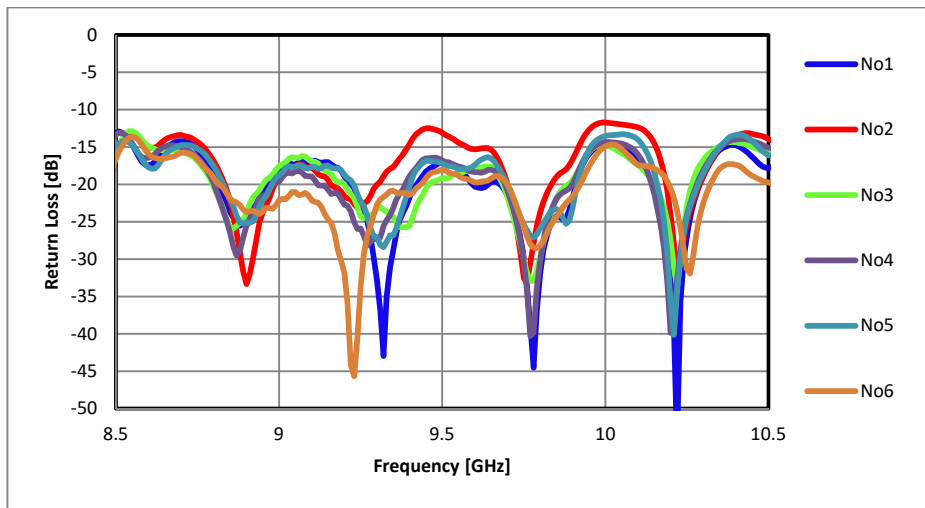

Figure 2. measured result of S11

The required bandwidth of antenna is 800 MHz which is from 9 GHz to 9.8 GHz. We decide the bandwidth where the S11 is under -10 dB in return loss graph. The result shows S11 value is located under -10 dB lies from 8 GHz to 11.7 GHz. This result satisfies the previous design requirements. However, the antenna named No. 2 shows non-identical characteristic to the other antenna modules.

Next, the measured result of axial ratio is shown in Fig. 3.

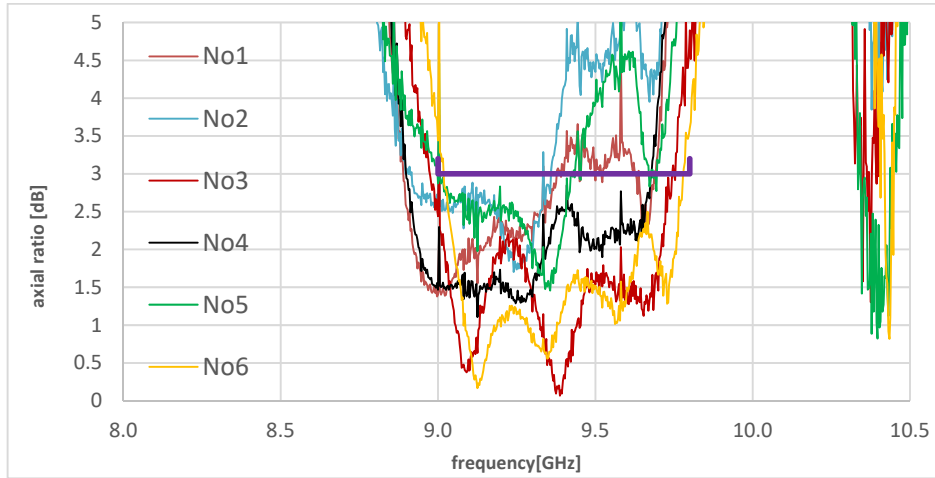

Figure 3. measured result of axial ratio

Axial ratio means the ratio between major axis and minor axis of ellipse polarization. Therefore, in ideal circular polarization, this value should be 1. In ideal linear polarization, the value becomes infinite. Generally, the wave that has axial ratio under 3 dB of axial ratio is defined as CP by IEEE. The bandwidth used in on-board SAR mission is 9GHz to 9.8GHz. For that reason, axial ratio need to be less than 3dB from 9GHz to 9.8GHz. However, every module could not achieve this requirement except for No6. Especially, No. 2 and No. 5 have worse characteristic. Their axial ratio could achieve only half of requirement. Comparing No. 6 which could achieve requirement roughly and them, there is big difference of characteristic.

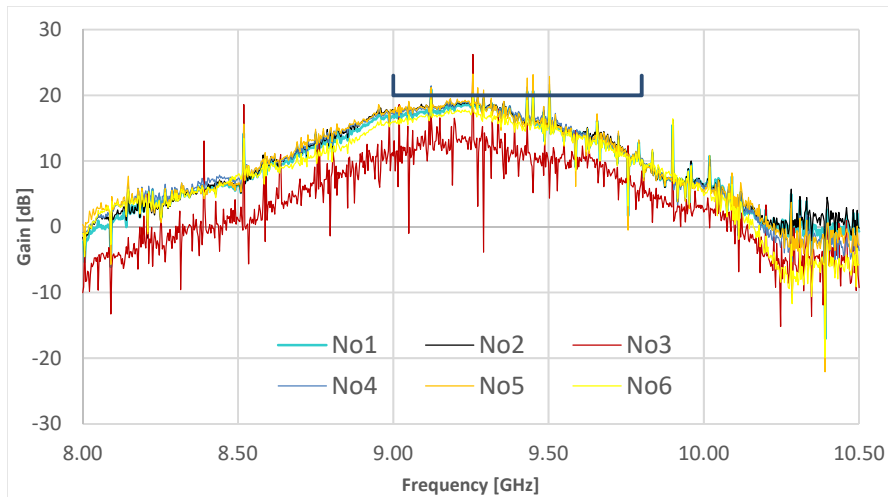

Figure 4. measured result of gain

Result of gain is shown in fig. 4. In the measurement results of gain, although noise during measurement is observed, satisfying result was obtained in used bandwidth of 800MHz. However, only No. 3 indicated different characteristic among six modules. Finally, results of radiation pattern are shown in fig. 5. Radiation pattern is measured in three points of 9 GHz, 9.4 GHz and 9.8 GHz in each module. In on-board SAR mission, tilt angle of 35 degrees is required. Fig. 5 shows all module can have the tilt angle and achievement of requirement.

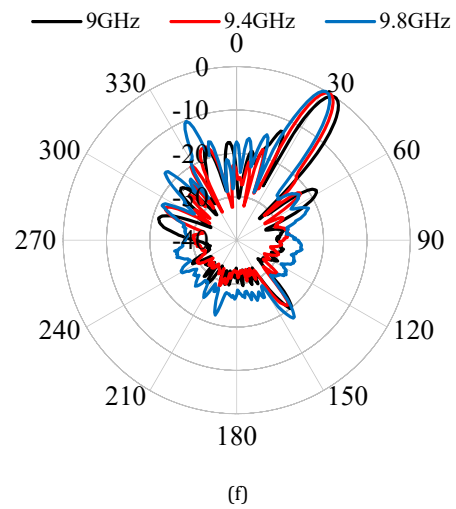
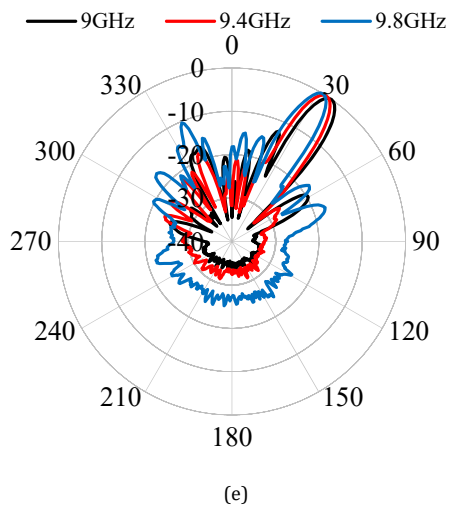
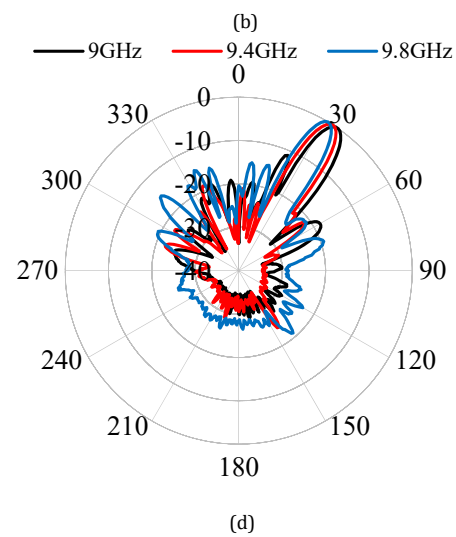
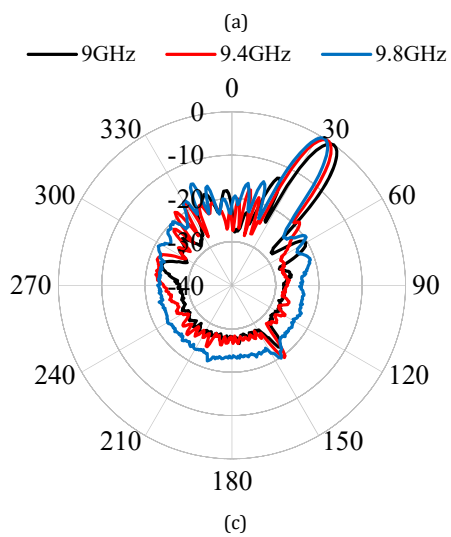
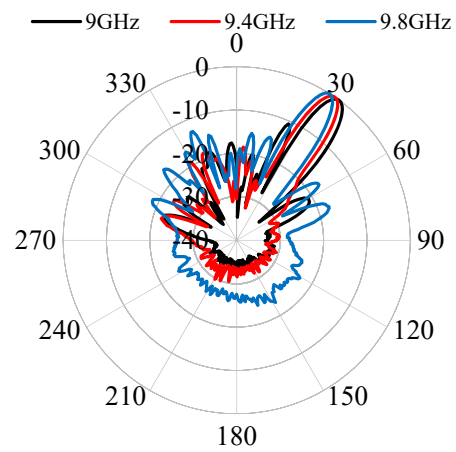
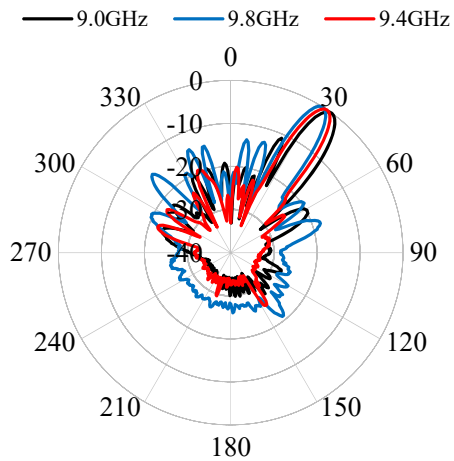

Figure 5. result of radiation pattern  
 (a)No.1 (b)No.2 (c)No.3 (d)No.4 (e)No.5 (f)No.6

## 5. CONCLUSION

X-band antenna for the airborne SAR mission has been designed and measured in this paper. The performance of proposed antenna has been examined using return loss, axial ratio, radiation pattern, and gain. Originally, 8-module array antenna has been designed to support 800 MHz of bandwidth and circular polarization. However only 6-module antenna has been examined in this paper. We separate each module and measure the performance in anechoic chamber. All the module shows satisfactory return loss characteristics. In the respect of axial ratio performance, half of modules have achieved design requirement; module No. 3, No. 4, and No. 6. On the other hand, module No. 1, No. 2, and No. 5 could achieve only half of requirement. In case of radiation pattern, every antenna shows that its beam has been tilted around 35 degree from the beam center. Last, gain has been measured, however, module No. 3 could not achieve the requirement value. As a reason, effect of sequential array method used in measured antenna is considered. Usually, in high frequency band, the size of antenna become smaller than low frequency band. In addition, the measured antenna has elements of 2x16 to realize sequential array and all element has phase difference. Therefore, the feed network for each element become more complicated than usual one. Therefore, small error which doesn't affect result usually become non-negligible error and affect to the result. In the future we will operate the proposed antenna using array. Then, as an effect of sequential array method, the proposed antenna can be used for airborne SAR mission.

## References

- C.A.Balanis, Antenna Theory Analysis and Design, John Wiley & Sons, Inc, 2005.
- V. Senthil Kumar, V.V.Srinivasan, V.K. Lakshmeesha and S.Pal "Sequentially Rotated Microstrip Array Antenna at X-Band for Spacecraft" IEEE,
- Yo, T.-C., C.-M. Lee, and C.-H. Luo. Compact circular polarized patch antenna with harmonic rejection. Microwave and Optical Technology Letters, 50(1):45-48, 2008.



## **The Effects Of Adequate Brisk Walking Exercise Toward Amount Of Pyramid Cells In The Cerebral Cortex Of Congenital Hypothyroid Pups**

*IdianiDarmawati<sup>a\*</sup>, Muhammad SatyaArifZulhani<sup>b</sup>,Zulkhah Noor<sup>c</sup>*

*A,b,c. Faculty of Medicine and Health Science Study Programe, UniversitasMuhammadiyah Yogyakarta  
Jalan Lingkar Selatan,Tamantirto Kasihan Bantul, Yogyakarta ,DIY , Indonesia, Pos Code: 55183  
Email: idianifkumy@gmail .com/ idiani2001@yahoo.com*

### **Abstract**

Hypothyroidism is a thyroid hormone deficiency disease that causes developmental abnormalities or disorders of nerve cells, especially pyramids cells in cerebral cortex, so that it can interfere daily activities and resulting low value of intelligence quotient (IQ). Pharmacological therapy is still lacking to help sufferers of hypothyroidism. Determine the effects of brisk walking exercise against the number of pyramid cells that are in the cerebral cortex of congenital hypothyroid rats. Postes to analyze changes in the number of pyramid cells in the cerebral cortex of congenital hypothyroid rats. Pups that born from each parents taken 5 pups, so we get 6 groups: normal without exercise, normal with exercise, hypothyroidism without exercise, hypothyroidism with exercise, hypothyroidism When it reaches the age of 8 weeks, pups brain tissue taken and made preparations so it can be compared the number of pyramid cells. First, the data is normality teted with *kolmogorov-smirnov* method. analyzed by *one way anova*. And *post hoc multiple comparison test*. The number of pyramid cells of normal group (66), normal training (88 ), hypothyroidism (47), hypothyroid exercise (59), hypothyroidism with thyroxine (85) and hypothyroidism with thyroxine and exercise (97). *One way anova* test result shows the result of  $p = 0.000$  ( $p < 0.05$ ) so can be said there are differences in the average number of pyramid cells are significantly among the six groups and adequate exercise brisk walking can increase the number of pyramid cells.

**Keywords :** hypothyroidism, thyroxine, brisk walking, pyramidal cells

### **1. Introduction**

Hypothyroidism is a thyroid hormone deficiency disease that causes the disorder or developmental disorder, especially nerve cells in the cerebral cortex pyramid cells, which can interfere with daily activities and lead to low grades Intelligence Quotient (IQ). Throughout the world the prevalence of hypothyroidism close to 1: 3000. While in Indonesia newborn screening results in some province found babies with congenital hypothyroidism about 1 in 305 live births. Cretin is a further consequence of iodine deficiency in the womb. Each patient cretin had a deficit of 50 IQ points. If found 1-10% of patients cretin populated, it is predicted that there 5-30% of children who suffered damage to part of his brain that it can not function optimally, and 30-70% of the population in the area is weak and unproductive because hipotiroid. (Samsudin, 2014).

Hipotiroid generally based etiology can occur because of primary failure of the thyroid gland itself, secondary to deficiency of TRH, TSH or both, and could also be due to lack of iodine intake and food. While the definition of congenital hypothyroidism is a

thyroid hormone deficiency disease inborn. One result of this condition is retarded mental. Growth brain cells and mental health requires thyroid hormone in sufficient quantities. When the body is deprived of thyroid hormones in the womb of his mother, a child will have mental retardation but mental retardation can be prevented if treatment is given promptly recovered, but can not be recovered when it has been established for several months after a person is born although then given hormones tiroid.(Sherwood,L.2011).

The brain can be likened to a special computer. human behavior depending on the programs that are inside. While the chip is the brain-nerve cells neuron.Salah the cells that are in the cerebral cortex is the pyramid cells. Selpiramida is a type of neuron "major excitatory" which use glutamate as ineurotransmitter. (Markam,2005). Hipotiroid alone can reduce the number of cells of the pyramid and the pyramid can stop cell growth at the age of 30 days in mice. ( Ruiz-Marcos, et al 2003). Fast walk is very simple activity and is one type of exercise is aerobic and can improve the physical condition (conditional fitness) of a person. If we move the body to the same thing we Also stimulate and train the brain, (Hasibuan, 2010). Because The brain itself is a center of the body driving. Irregular body movements and measured, in addition to body refresh , will Also increase of the blood flow in your body Including diotak.5 So with the study expected later this useful and can help sufferers of hypothyroidism in order to improve Reviews their quality of life.

## 2. Material And Metods

This study was an experimental study, design posttest only control group design. Postes to analyze changes in the number of pyramid cells in the cerebral cortex of hypothyroid rats kongenital.Subjek this study is the mother rats (*Rattus norvegicus*) *Sprague Dawley*, 4-5 months of age, healthy and ready to mate and pregnant .In this be used Sprague Dawley because they are more sensitive to hormones, resistant to treatment, omnivorous, have physiological characteristics more like humans than rabbits and can be controlled in terms of food intake to reduce the occurrence of bias in study.

Pregnant parent required as many as 12 were divided into 6 each group of two tails. Four (4) groups induced hypothyroidism with given prophiltiourasil (PTU), 2 Other groups of Other normal.group . Mice children are born grouped by treatment among other things normal without treatment (K I), normally with a brisk walk adequate on a treadmill at a speed of 10 m / min (K II), hypothyroidism without treatment once the child is born from the mother who gets propyl tiourasil 15 ppm during gestation (K III), hypothyroidism with adequate brisk walking on a treadmill at a speed of 10 m / min (K IV), hypothyroidism with thyroxine treatment by therapy of 1.6 ug / g thyroxine (K V), and hypothyroidism with thyroxine treatment and brisk walking adequate (K VI). Randomization was performed on the mother and children in a single parent, it is because children are still suckling mice for approximately 20 days. Each treatment group using 5 mice pups. The size of the sample can be calculated by the formula Federer (1963), after calculation s0 that obtained a minimal amount of sample required is 4 rats untuksetiap group. Once the child Reaches the age sufficient mice (8-10 weeks) will be terminated by using chloroform and brain tissue will be taken. The brain tissue preparations will be made and observed with a microscope with a magnification of 100x ( $23 \times 17 \mu\text{m} = 391 \mu\text{m}^2$ ). This research was conducted in UPHP UMY for maintenance, administration of stem treatment, replacement thyroxine hormone treatment, the provision of treatment of children in the form of brisk walking rats on a treadmill mice and rat brain surgery organ harvesting. Making the mouse brain preparations carried out in the Laboratory of Pathology Anatomy Faculty of Medicine. Filming is done in preparation Histology

Laboratory of the Faculty of Medicine . Materials and Instrument research include mother rats white *Sprague Dawley*12 tail, mouse cage, feeding rats, treadmill rat, Propylthiouracil (PTU), thyroxine, a bottle of mineral water a used along with cap and hose, enough water, the drug (chloroform), jars, surgical equipment rat , pot to save the network, which has been diluted alcohol, glass preparations, microscopes and cameras, calculators, computers and others. Data Obtained from observations of a numerical scale the data. Because, in research inimenggunakan 6 treatment groups (> 2 groups) and not a variable pairs (independent) to test the hypothesis, the difference in all treatment groups used OneWay ANOVA statistical analysis. Before the Data were tested for normality using the descriptive method and metod eanalitikujiShapiro-Wilk because the sample size 30. If it comes to data distribution is not normal, then the statistical test used was Kruskal Wallis. Then, to compare the effect of each terapipada each group against another group, used to test the Post Hoc Multiple Comparison Test. The analytical data obtained from histological observation in mice brains of test animals.

### 3. Result and Discussion

The following image pyramid cell histology cerebral cortex of group I Group II, Group III , Group IV, group V and Group VI:

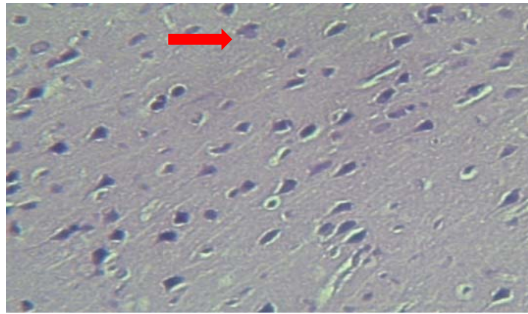

Figure a.  
Overview of Histology Cells Rat cerebrum cortex Pyramids Normal H E (hematoxylin eosin, 100x total magnification, wide field of view of 23 x 17  $\mu\text{m}$  = 391  $\mu\text{m}^2$ ) :: Selpiramid

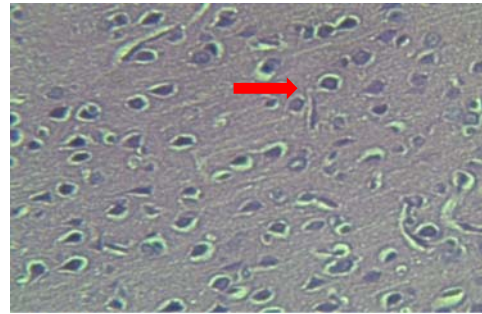

Figure b.  
Overview of Histology Cells Rat cerebrum cortex Pyramids K II Normal practice (Hematoxylin Eosin, 100x total magnification, wide field of view of 23 x 17  $\mu\text{m}$  = 391 $\mu\text{m}^2$ ) . Pyramids Cells

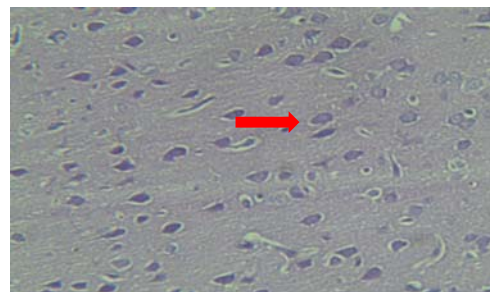
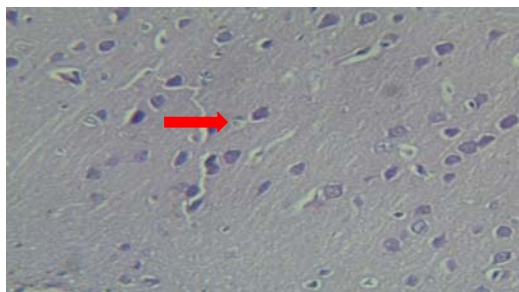

Figure c.  
Overview of Histology Cells Rat cerebrum cortex Pyramids Normal HE (hematoxylin eosin, 100x total magnification, wide field of view of 23 x 17  $\mu\text{m} = 391 \mu\text{m}^2$ ) .: Selpiramid.

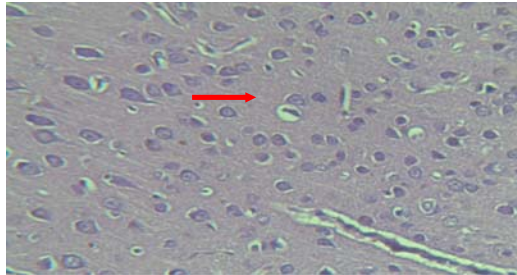

Figure d.  
Overview of Histology Cell Pyramids Rat cerebrum cortex K IV Hypothyroidism exercise (hematoxylin eosin, 100x total magnification, wide field of view of 23 x 17  $\mu\text{m} = 391 \mu\text{m}^2$ ) .: Pyramid Cells

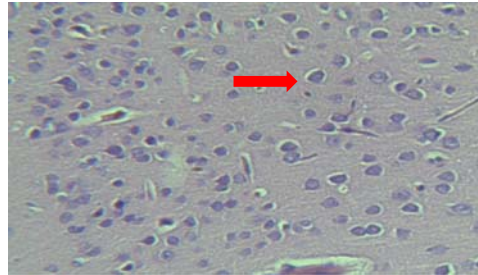
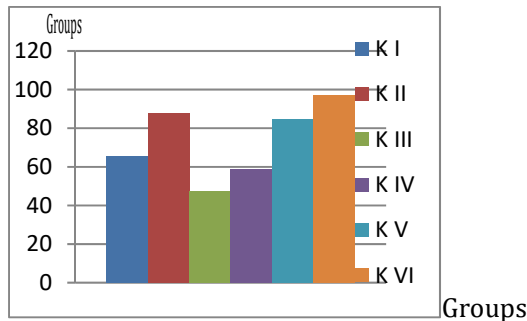

Figure e.  
Overview of Histology Cells Rat cerebrum cortex Pyramids K V hypothyroidism thyroxine and exercise (hematoxylin eosin, 100x total magnification, wide field of view of 23 x 17  $\mu\text{m} = 391 \mu\text{m}^2$ ) .: yramids Cells Pyramids

Figure f.  
Overview of Histology Cells Rat cerebrum cortex Pyramids K VI hypothyroidism thyroxine and exercise (hematoxylin eosin, 100x total magnification, wide field of view of 23 x 17  $\mu\text{m} = 391 \mu\text{m}^2$ ) .: Pyramids Cells

The results are also presented in histogram form that makes it easier to compare the results, as follows



Discription :  
 K I = Normal untreated  
 K II = Normal exercise brisk walking  
 K III = Hypothyroidism  
 K IV = Hypothyroidism with brisk walking workout  
 K V = hypothyroidism with thyroxine therapy  
 K VI = hypothyroidism with thyroxine and road cepatl

Table 1. Average number of pyramid cells

Number	Mice Groups	Average $\pm$ SD
1	Normal without treatment (K I)	66 $\pm$ 7
2	Normal exercise brisk walking (K II)	88 $\pm$ 12
3	hypothyroidism (K III)	47 $\pm$ 10
4	Hypothyroidism with brisk walking workout (K IV)	59 $\pm$ 4
5	hypothyroidism with thyroxine therapy (K V)	85 $\pm$ 7
6	hypothyroidism with thyroxine and a brisk walk (K VI)	97 $\pm$ 18

In accordance with the tables 1 and histogram above it can be concluded that the number of cells contained the highest pyramid on the group VI, namely congenital hypothyroid rats treated with thyroxine and fast way adequate. While the number of cells contained in the pyramid at least the third group, which is congenital hypothyroid mice without any treatment or therapy. (Table 2)

Table 2 value significance between groups \* = Value <0.05 or obvious that there is a difference between information the groups is:

Group	I	II	III	IV	V	VI
KI	-	0,003*	0,012*	0,327	0,009*	0,000*
KII	0,003*	-	0,000*	0,000*	0,663	0,198
KIII	0,012*	0,000*	-	0,101	0,000*	0,000*
KIV	0,327	0,000*	0,101	-	0,001*	0,000*
KV	0,009*	0,663	0,000*	0,001*	-	0,090
KVI	0,000*	0,198	0,000*	0,000*	0,090	-

Discription :

K I = Normal untreated

K II = Normal exercise brisk walking

K III = Hypothyroidism

K IV = Hypothyroidism with brisk walking workout

K V = hypothyroidism with thyroxine therapy

K VI = hypothyroidism with thyroxine and road cepatl

After the results are displayed, the normality test beforehand to determine the distribution of the data, by using the Shapiro-Wilk test, because the sample size of 30. The results of this test to the whole group shows the results  $p > 0.05$ , so that shows the distribution of the number of normal pyramid cells . Therefore the continued data analysis using One Way Annova. One Way Annova test results show the result  $p = 0.000$  ( $p < 0.05$ ) so that it can be said there are differences in the average number of pyramid cells are significantly among the six groups. Once known there were significant differences among the six groups, then do LSD (Least Significant Difference) in post hoc test to determine which groups are different. LSD test results obtained significant differences in the KI KII, with KIII KI, KI with KV, KI with KVI, KII with KIII, KII with KIV, KIII with KV, KIII with KVI, KIV with KV, KIV with KVI. The value of significance between treatments can be seen in Table 2 In addition, to ensure and prove that the mother rats and mice induced PTU really managed to become hypothyroid rats, the rats have blood drawn prior to the data taken FT4 results can be seen in Table 3

Table 3. Mean FT4 levels of mice treated

Group	FT4 serum levels (ng / mL)		
	Parent	Parent Child Day 15	Children 2 Month
KI	1,42±0,158	1,09±0,145	1,32±0,211*
KII	1,37±0,162		1,77±0,113**

K III	0,07±0,089	0,09±0,164	0,50±0,094***
K IV	0,122±0,106		1,46±0,327*
K V			1,50±0,20*
K VI	0,23±0,13	0,21±0,17	1,20±0,33

Discription :

Discription :

K I = Normal untreated

K II = Normal exercise brisk walking

K III = Hypothyroidism

K IV = Hypothyroidism with brisk walking workout

K V = hypothyroidism with thyroxine therapy

K VI = hypothyroidism with thyroxine and road cepatl

Kruskal Wallis test:  $p = 0.002$

Extensive details: \* The number of different shows significant differences in  $p \leq 0,05$  PTU given to mother rats cause hypothyroid conditions to the parent as well the son concentration; FT4 hypothyroid rats induced PTU significantly lower than other groups. Hypothyroid group FT4 levels with exercise can increase up to par with the normal group ( $p > 0.05$ ). While hypothyroid mice receiving thyroxine therapy and exercise treatment also showed similar elevated levels of FT4 normal group of rats.

Test Result of the One Way Anova on the average number of pyramid cells showed  $p = 0,000$ . results showed that  $p < 0,05$ , so that the statistical tests showed that the number of pyramid cells in the cerebral cortex and control have significant differences. The results obtained in accordance with previous hypotheses.

Thyroid , which consists of thyroxine (T4) and triiodothyronine (T3), is essential for normal growth and development of fetus thyroid .Hormon needed for the general growth of fetal life and trigger the development of discrete in fetal brain and somatic tissue early in pregnancy. These hormones also influence idiferensiasi terminal of fetal tissue and gives the effect of prepartum maturation of glukokortikoids that will ensure the survival of the baby. Hormontiroid acting directly through anabolic effects on fetal metabolism and oxygen consumption fetus stimulation. Hormon also acts indirectly by controlling the bioavailability and efficacy of other hormones and growth factors that affect fetal development such as catecholamines and insulin-like growth factors (Forhead & Fowden, 2014).). PTU is a medicine used to lower levels of tirod. Clinical study mentioned that the thyroid hormone affects the formation of cholesterol, especially low density cholesterol (LDL). By giving this drug in the pregnant mother on a certain dose (in this study stem induced a dose of 15 ppm during pregnancy) will be born children who suffer from congenital hypothyroidism. (Furi, & Wahyuni, 2011).The main determinants though not the only determinant of the basal metabolic rate is the job of the thyroid hormone. Increased thyroid hormone alone can lead to an increase BMR.Namun case of hypothyroidism in which the symptoms are generally caused by a decrease in metabolic activity as a whole, then a person with hypothyroidism will decrease basal metabolic rate. (Sherwood, 2011). Decreased metabolic rate will cause hyperglycemia conditions, so it will be conditioned are conducive oxidative stress, a condition in which compared to endogenous oxidant. These conditions will cause organ damage jaringan tau that have a high fat content, because fat is very susceptible to radical attack Itself is free. (Winarsi at al 2012).

While one of the main organs of the brain with a very high fat content ( $\pm 80\%$ ), so the brain vulnerable to free radical attack. This will lead to an increase nekrosa

pyramidal neurons in particular neuron in hypothyroid rats group. So that this condition will reduce the number of pyramid cells in group hipotiroid. (Utami,2003). Fast walking is fitness exercise consisting of aerobic running at high speed by moving the arms energetically. The definition of this jalancepat located between walking and running, done in a way that requires cognition and concentration in an individual to do so. The fundamental difference of running is the one leg that remains on the ground, while running there is a condition in which both feet float. (Depdiknas. (2002). *Based on research Xiaofeng Shen et al (2013) under the title The Effect of Different Intensities of Treadmill Exercise on Cognitive Function Deficit Following a Severe Controlled Cortical Impact in Rats* can be concluded that the treadmill exercise can improve cognitive function and BDNF after TBI (Traumatic Brain Injury) , TBI itself will cause the nerve cells or neurons die, resulting in deficits in learning and memory space. In cases of hypothyroidism are also almost similar pathophysiology, where nerve cells are also in deficit because of their exposure to radical bebas.Sedangkan BDNF itself is part of the "neurotropic factor" (Group of protein responsible for the growth and survival of neurons and repair of mature neurons) that this overflow.BDNF facilitate the growth, proliferation and differentiation of neurons BDNF hippocampus.12 is not only found in the hippocampus, but also there are padakorteks cerebrum. BDNF can be detected in low numbers in mice postnatal day 2 and there is a high number of type Ausia 5 minggu.13 Shen et al. 2013) Therefore, by doing brisk walking exercise adequately during the growth of onshore tmerangsang BDNF, so the existing pyramid cells at cortekxs cerebrum more numerous in the exercise group compared to the group without exercise.

#### **4.Conclusion**

In this study we can conclude that with adequate exercise brisk walking can increase the number of pyramid cells in the cerebral cortex of congenital hypothyroid rats.

\* Corresponding author. Tel.: +62 817 940 4442; fax: +62 274 387 646.  
E-mail address: idiani@umy.ac.id/idianifkumy@gmail.com/idiani2001@yahoo.com

#### **References**

- Depdiknas. (2002). Pedoman Pencak Silat, Pedoman Atletik Untuk Klub Olahraga Usia Dini. Jakarta: Ditjend Dikdasmen.
- Shen, X., Li, A., Zhang, Y., Dong, X., Shan, T., Wu, Y., et al. (2013).The Effect of Different Intensities of Treadmill Exercise on Cognitive Function Deficit Following a Severe Controlled Cortical Impact in Rats. *Molecular Sciences*, Vol.14, No.11, pp.21598-21612.
- Furi, P. R., Wahyuni, A. S. (2011). Pengaruh Ekstrak Etanol Jamur Lingzhi (*Ganoderma lucidum*) Terhadap Kadar HDL (High Density Lipoprotein) Pada Tikus Dislipidemia Pharmacon,Vol.2, No. 4, pp.5.
- Forhead, A., Fowden, A. (2014). Thyroid Hormones in Fetal Growth and Prepartum Maturation, Vol.22, No.3, pp.87-103.
- Hasibuan, R. (2010). Terapi Sederhana Menekan Gejala Penyakit Degeneratif. Vol. 8, No. 2, pp.78-80.

- Huang, Z., Kirkwood, A., Pizzorusso, T., Porciatti, V., Morales, B., Bear, M., et al. (2000). BDNF Regulates the Maturation of Inhibition and the Critical Period of Plasticity in Mouse Visual Cortex. *Cell*, Vol. 98, No. 6, pp. 739–755.
- Markam, S. (2005). *Latihan Vitalisasi Otak*. Jakarta: Grasindo.
- Ruiz-Marcos, A., Sanchez-Toscano, F., Escobar, F., Morreale, G. (2003). Severe Hypothyroidism and The Maturation of The Rat Cerebral Cortex. *Brain Research*, Vol.162, No. 2, pp.315–329.
- Samsudin, M. (2014). Nilai Diagnostik Indikator Fisik Dibandingkan Baku Emas Untuk Menegakkan Diagnosis Terduga Kretin Pada Batita. *MGMI*, Vol. 5, No. 2, pp.112.
- Shen, X., Li, A., Zhang, Y., Dong, X., Shan, T., Wu, Y., et al. (2013). The Effect of Different Intensities of Treadmill Exercise on Cognitive Function Deficit Following a Severe Controlled Cortical Impact in Rats. *Molecular Sciences*, Vol. 14, No. 11, pp.21598-21612.
- Sherwood, L. (2011). *Fisiologi Manusia Dari Sel ke Sistem*, Ed.6 ed. Jakarta: EGC.reference.
- Utami, P. (2003). *Tanaman obat untuk mengatasi diabetes mellitus*. Jakarta: AgroMedia.
- Winarsi, H., Wijayanti, S., Purwanto, A. (2012). Aktivitas Enzim Superoksida Dismutase, Katalase, dan Glutation Peroksidase Wanita Penderita Sindrom Metabolik. *MKB*, Vol. 44, No. 1, pp.7-11.



---

**IMPLEMENTATION ON REDUCTION LUT MEMORY SIZE  
IN CHIRP SIGNAL GENERATION FOR SATELLITE ON-BOARD SAR**

Min-Wook Heo<sup>a\*</sup>, Tu-Hwan Kim<sup>a</sup>, Kyeong-Rok Kim<sup>a</sup>, Jae-Hyun Kim<sup>b</sup>,  
HeeinYang<sup>c</sup>, Josaphat Tetuko Sri Sumantyo<sup>c</sup>

<sup>a</sup>Department of Space Electronics and Information Technology,  
Ajou University, San 5, Woncheon-Dong, Yeongtong-Gu, Suwon 443-749, Korea

<sup>b</sup>Department of Electronics and Computer Engineering,  
Ajou University, San 5, Woncheon-Dong, Yeongtong-Gu, Suwon 443-749, Korea

<sup>c</sup>Center for Environmental Remote Sensing,  
Chiba University, 1-33, Yayoicho, Inage Ward, Chiba-shi, Chiba, 263-8522 Japan

---

**Abstract**

The synthetic aperture radar(SAR) is an active sensor that is mounted on moving platform such as aircraft or satellite. It uses electromagnetic waves for the target detecting signal which can penetrate the Earth atmosphere. For that reason, it can obtain target images regardless of the weather condition. Generally, it obtains higher resolution images with the wide bandwidth reference signal. So it takes linearly frequency modulated (LFM) signal called chirp. The instantaneous frequency of chirp signal increases as time, so that this signal can enlarge the bandwidth. In this paper, we suggest the parallel direct digital synthesizer (PDDS) chirp signal generator to generate the wide bandwidth chirp signal. The proposed PDDS signal generator consists of 4-DDS in paralleled and 4 look-up tables (LUTs) those are cascaded to each DDS unit. By using the PDDS method, it takes an advantage on the clock frequency resource, but it occupies large memory resources. When implementing SAR system in satellite platform, the size of memory unit is a critical unit.

To solve this problem, we suggest the LUT memory reduction method for using micro satellite use. Using the sinusoid, we divide one period of the sinusoid in quarter. We add an algorithm that represents a one period signal using the quarter signal of sinusoid, generate chirp signal and coded. The memory size of chirp signal generation algorithm is compared with conventional method through simulation. The memory that is used by generating chirp signal in entire system is confirmed by simulation that reduce about a quarter of conventional method. Because it applies the same algorithm in system generator, if it uses higher LUT output bit, ratio of the memory reduction will be increase. Therefore, it is considered that if it uses the same amount of memories, it would be able to design a chirp signal that has a better characteristic.

**Keywords**

SAR, PDDS, LUT, memory reduction , system generator,

---

\* Corresponding author. Tel.: +82-10-5106-6120.  
E-mail address: gjalsdnr8910@gmail.com

## 1. Introduction

At memory-map based chirp signal generation used in the existing satellite SAR, the memory device has the disadvantage that likely to be damaged in a space environment. Chirp signal generator of DDS method has an advantage that a low dependence on the memory device. But, there is a disadvantage that the memory consumption is large due to LUT. Chirp signal generator of conventional DDS method, it save and use all of the sine wave 1 cycle in LUT in order to represent the sine and cosine wave. In this paper, rather than 1-cycle of the sine wave stored on LUT, we propose a way to reduce the LUT memory size that is used to save only a quarter period.

## 2. Chirp signal generation of PDDS method

Chirp signal, as the type of linear frequency modulation(LFM) signal that frequency varies linearly with time, it's characterized with wide bandwidth. Resolution( $r$ ) of the SAR, as in Equation (1), is inversely proportional to the bandwidth of the transmitted signal, mainly use a chirp signal with a wide bandwidth in the SAR. In Equation (1),  $c$  is the speed of light,  $B$  is the bandwidth.

$$r = \frac{c}{2B} \quad (1)$$

$$s(t) = \text{rect}\left(\frac{t}{T}\right) A e^{i\pi K t^2} \quad (2)$$

Equation (2) shows a formula that defines the chirp signal,  $t$  is time,  $T$  is the pulse width,  $K$  is the chirp rate that rate of change of the frequency as time,  $A$  is the amplitude of the signal[1][2].

Although you can generate the Chirp signal using the DDS system, it requires a high clock frequency. However, in a satellite environment, it is difficult to generate the high clock frequency on the performance limits of the clock generator. Thus, by connecting a number of DDS that is relatively low operating clock in parallel, it can be used up system operation clock of the PDDS method[3].

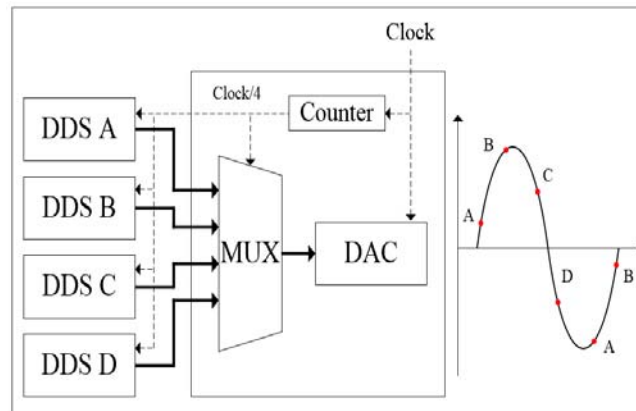

Figure 1. Structure of the PDDS.

Fig.1 is a diagram showing a PDDS method used by connecting 4-DDS blocks generating a chirp signal in parallel to the MUX. PDDS method, because 4-DDS blocks of

each generate a chirp signal, occupied more memory size in the entire system than DDS method that using 1-LUT. Chirp signal generation of PDDS method have a large proportion of LUT. If there is a large bit number of the desired output signal, it can't input a code into the board caused by the memory limit of FPGA that is hardware for signal generation. For the reason, it can be a problem of lowering the requirements of the chirp signal.

### 3. LUT reduction solution

In general, the phase information that necessary for the chirp signal generation is stored in a sine wave form of 1-cycle in the LUT in each PDDS block[4]. The output bit number of sine wave is taken as  $n$ , the size of the data stored in the LUT is proportional to the length of the sine wave stored in LUT and  $2^n$ . It is necessary to use a sine wave of short cycle in the LUT in order to reduce the entire memory size as generating a signal of the same performance. As a solution, first, saving only a quarter period of sine wave in the LUT. Second, arranging the four wave as shown in Fig. 2(a). Third, making wave between  $\pi/2$  and  $\pi$ ,  $3\pi/2$  and  $2\pi$  to vertical symmetry (Fig. 2(b)). Finally, by changing the wave of between  $\pi$  and  $2\pi$ , it is possible to sine wave representation of one period as shown in Fig. 2(c). In this paper, we implement digitally the chirp signal generator algorithm and the LUT reduction algorithm of PDDS method using the parameters shown in Table 1 through the system generator of the MATLAB. Then, we compare with conventional method the memory size occupied by the chirp signal generation algorithm of PDDS method using the ISE Project Navigation 14.7. Target board of ISE Project Navigation 14.7 that was used to code generation is set to Xilinx virtex-5 XC5VFX130T.

Table 1. Parameters of the signal generator used in the simulation

Parameters	Value	Unit
Pulsewidth	13.3	us
Bandwidth	75	MHz
Number of DDS	4	ea
Output bit	10	bits

Table 2. Comparison of the simulation result

	Unapplied LUT reduction	Applied LUT reduction
Number of slice LUTs (ea)	832	768
Total Memory used (KB)	432	114

Table 2 is a simulation results. As a result, in case of using the number of the LUT saved by a quarter period of the sine wave in the LUT, it was not significantly reduced from 832 to 768. However, as the used entire memory is 114 KB, it is equivalent to 26.38% of 432 KB as compared to the case of using 1-cycle.

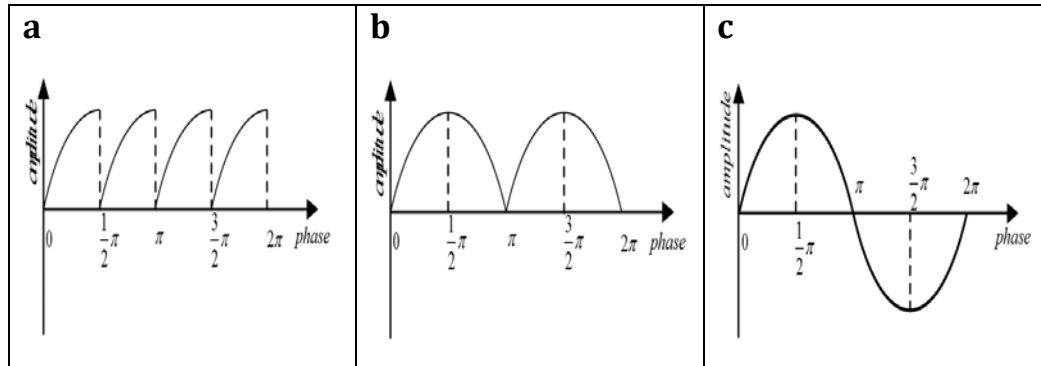

Figure 2. Sine wave representation through the phase and amplitude conversion.

## 4. Conclusion

In this paper, we propose on how to reduce the LUT size of the chirp signal generator mounted satellite SAR. We use the system generator that is a program to generate chirp signal and the algorithm of the PDDS method. In system generator, the period of the sine wave stored in the LUT is reduced to a quarter. We add the algorithm for representing 1-cycle by using the signal, generate a chirp signal, and coded. The memory size of chirp signal generation algorithm is compared with conventional method through simulation. The memory that is used by generating chirp signal in entire system is confirmed by simulation that reduce about a quarter of conventional method. Because it applies the same algorithm in system generator, if it uses higher LUT output bit, ratio of the memory reduction will be increase. Therefore, it is considered that if it uses the same amount of memory, it would be able to design a chirp signal that has a better characteristic.

## Acknowledgements

This research was supported by Korea Aerospace Research Institute(KARI) through the Ministry of Science, ICT and Future Planning.

## References

- [1] Cumming, I. G. and Wong, F. H. (2005). Digital Processing of synthetic Aperture Radar Data.
- [2] Koo, V. C. and Chua, M. Y. (2009). FPGA-based chirp signal generator for high resolution UAV SAR. Progress In Electronics Research, vol. 99, pp. 71-88,
- [3] Samarah, A. (2012). A novel approach for generating digital chirp signals using FPGA technology for synthetic aperture radar applications.
- [4] Vankka, J. (1997). Methods of mapping from phase to sine amplitude in direct digital synthesis. Ultrasonics, Ferroelectrics, and Frequency Control, IEEE Transactions on 44.2 pp. 526-534.

---

## **The archaeological investigation of the central Jawa applying the advanced remote sensing technology**

Kageaki Inoue<sup>a</sup>, Josaphat Tetuko Sri Sumantyo<sup>b</sup>, Agus Hartoko<sup>c</sup>, Achmad Fama<sup>d</sup>,  
Hiroaki Kuze<sup>e</sup>

<sup>a,b,e</sup> Center for Environmental Remote Sensing, Chiba University, 1-33, Yayoi-cho, Inage-ku,  
Chiba-shi 263-8522 Japan

<sup>c,d</sup> Diponegoro University, Prof. Soedarto Street, Semarang City, Central Java 50275  
Indonesia

---

### **Abstract**

Nowadays the study using Structure from Motion (SfM) to mapping unstructured aerial images using some commercial optical sensors onboard small Unmanned Aerial Vehicle (UAV) has been increasing in several research fields. In this study, we applied this UAV-SfM technology for Geology and Paleontology fields, and study area is Sangiran area in central Jawa, Indonesia. Conventionally, it is difficult to get information of the sedimentation process and the layer type in Archaeological area. It is also difficult to specify the exact location and type of fossils are. Our proposed technology solved these problems by using low cost equipment, spending less time for preparation and mapping process, and providing high resolution 3D images with the locational and the geological information. Firstly, several photographs which were aurally shot using the commercial digital camera onboard small UAV were obtained and some fossils sample with GPS data used by digital camera collected in the study area simulteneously. Next, point clouds, high resolution 3D images, DSMs, Orthophotographs were generated by the calculation of those photographs data using the SfM technology. And also, to combine the image processing of DIn-SAR with UAV-SfM technique provide us the information of Geological both detailed and overall changes in Sangiran area.

### **Keywords**

*Keywords: UAV; SfM; Geology; Paleontology; Archaeology; Image processing; D-InSAR; Sangiran; Central Jawa*

## 1. Introduction

Nowadays, the remote sensing technology using small UAV and SfM (Structure from Motion) has been increasing. This technique is applied for several research field especially geology. This technique has the advantage for inaccessible area. Small UAV can be operated from start point to about 200m manually. If autopilot system of the UAV can be used, small UAV can flight about 1000m distance. In archeological survey, the investigation was carried out in only accessible area conventionally but this technique can make us access to inaccessible area. D-InSAR image processing is also advanced remote sensing technology. It can make sure where crustal deformation happened. In this study, both UAV-SfM technique and D-InSAR image processing are applied for archeological area and we want to show how effective this advanced remote sensing technology is for archeology, geology and paleontology.

## 2. Methods

The flowchart in this study is below.

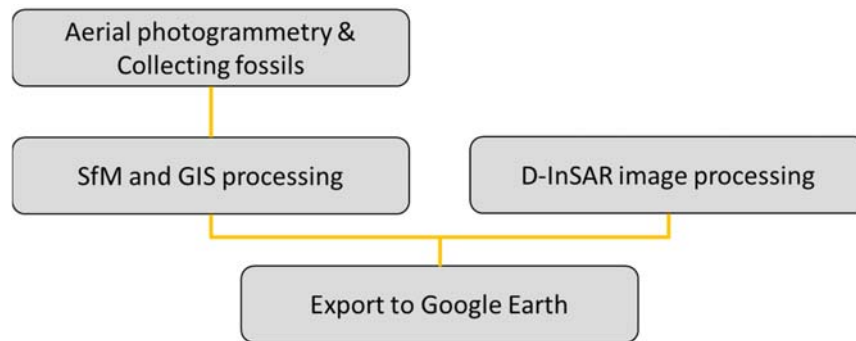

Figure 1. Flowchart of methods

At first, the investigation concluded getting aerial photographs and collecting fossils was carried out. Next, SfM & GIS processing and D-InSAR image processing have been done simultaneously. Final, both data was exported to Google Earth.

### 2.1. The small UAV

In this study, “DJI Phantom2” was used as small UAV. It can be operated easily without special knowledge about the radio-controlled vehicle. This UAV has 4 propellers and it is also called Quad-Copter. It contains GPS inside body and it can adjust aerial location automatically. The size is 400mm \* 400mm \* 190mm, weight is 1030g, max flight time is 25min, and payload limitation is about 300g.



Figure 2. DJI Phantom2

## 2.2. *The digital camera*

In this study, “Nikon COOLPIX A” was used as the optical sensor onboard the small UAV. It can be installed size and weight to the small UAV, which can get high-resolution images with a single-lens reflex camera. The most important function is the interval shooting function during aerial photography. Less than 1-sec interval time is the best for usual aerial photography. This camera has minimum 1-sec interval time. Nikon sells separate GPS unit which can be set on COOLPIX A. In advance this GPS unit should be set on it and this is how the aerial images can get GPS information. These GPS information is so effective to build 3D-models after that.



**Figure 3. Nikon COOLPIX A**

## 2.3. *Aerial photography*

We visited Sangiran in central Jawa in 30 April to 1 May 2016. Observation sites were Duku Ngampon, Pablengan, Drepo and Kabuh in Sangiran. They were fine days in all investigation times. Basically, taking aerial photographs were carried out twice in each area. One is a horizontal shoot, the other is about 45 degree look angle shoot. One flight time is less than 15-min in each area. We shorten 10-min than maximum flight time 25-min because of loading digital camera on UAV and safety operation.

## 2.4. *Collecting fossils*

Fossils were collected each area in order to classify the type of them and register the location where each fossil existed. If fossils locations are registered, the images with GPS information is very effective and they help us to notify the location on their 3D-models.

## 2.5. *SfM processing*

In this phase, 3D-models can be built by SfM (Structure from Motion) processing on the software (Agisoft Photoscan). SfM is a technique that calculates the three-dimensional geometry (Structure) and the camera attitude change (Motion) simultaneously by tracking feature points in each image of the moving camera. The feature points mean a characteristic part of the objects in each image.

## 2.6. ArcGIS processing

In this phase, the DSM of Drepo area was made from that 3D-model on ArcGIS. In advance, the las data of 3D-model should be exported on Photoscan in order to make DSM on ArcGIS. The noted point is to change coordinate from WGS84 to UTMzone49S. This processing can help us to find height value of the layer in each area.

## 2.7. D-InSAR processing

D-InSAR image processing was analyzed on SNAP. The images from ALOS-2 were used and these images are in 8 Feb 2015 and 7 Feb 2016. Thus the displacement for one year was analyzed in this study. The flowchart of this phase is as below.

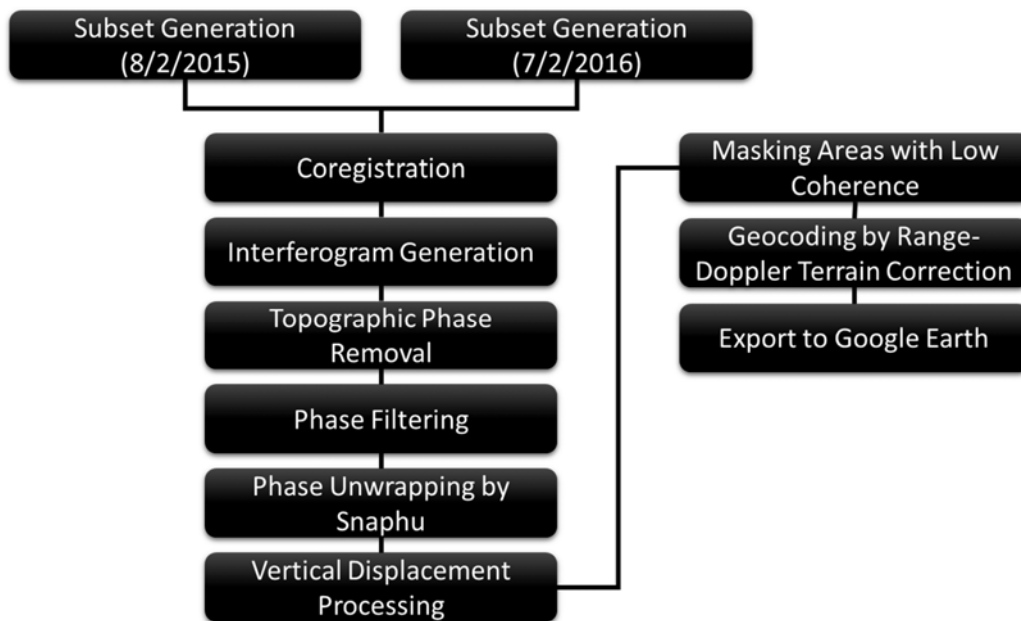

Figure 4. Flowchart of D-InSAR image processing



### 3. Results

#### 3.1. 3D models



Figure 5. 3D-model of Drepo 1

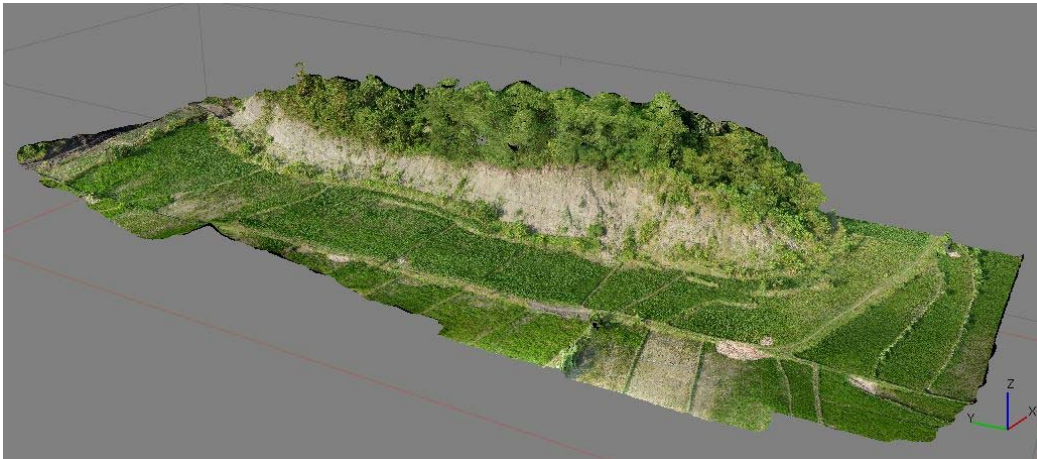

Figure 6. 3D-model of Drepo 2

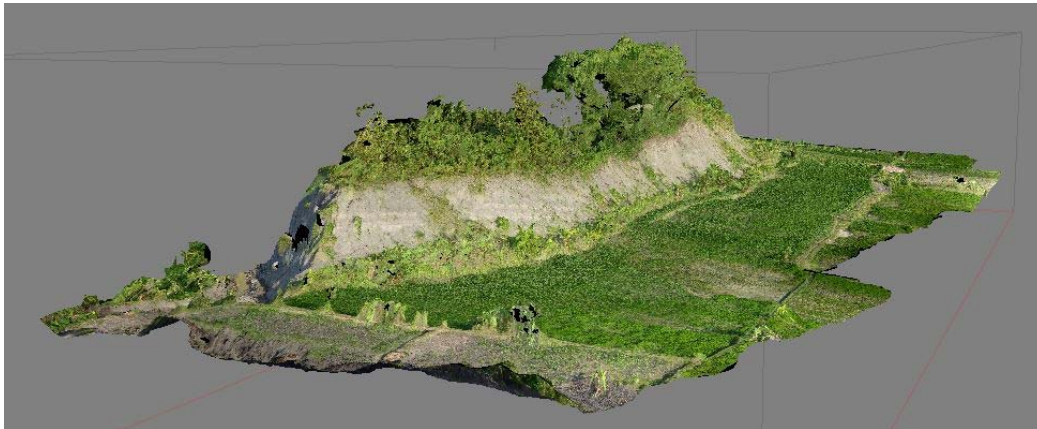

Figure 7. 3D-model of Drepo 3



Figure 8. Fossils in Drepo

### 3.2. Orthophotograph



Figure 9. Orthophotograph of Drepo

### 3.3. ArcGIS processing

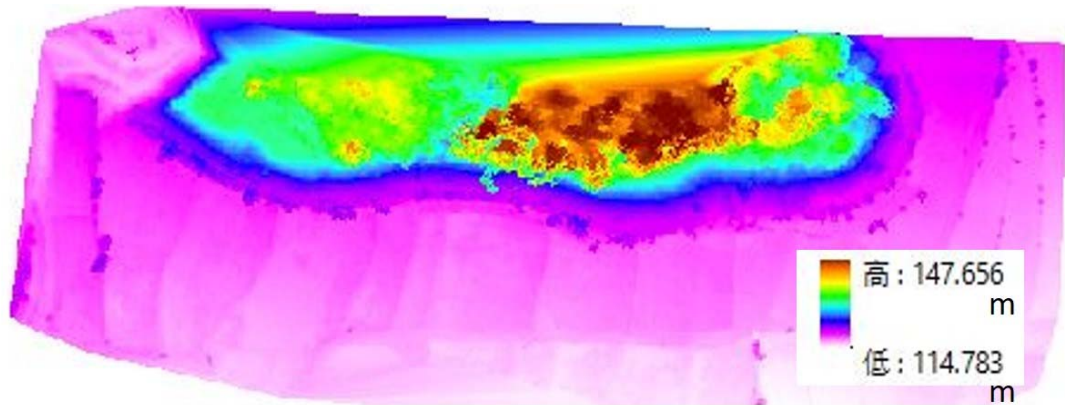

Figure 10. DSM of Drepo

### 3.4. D-InSAR image processing

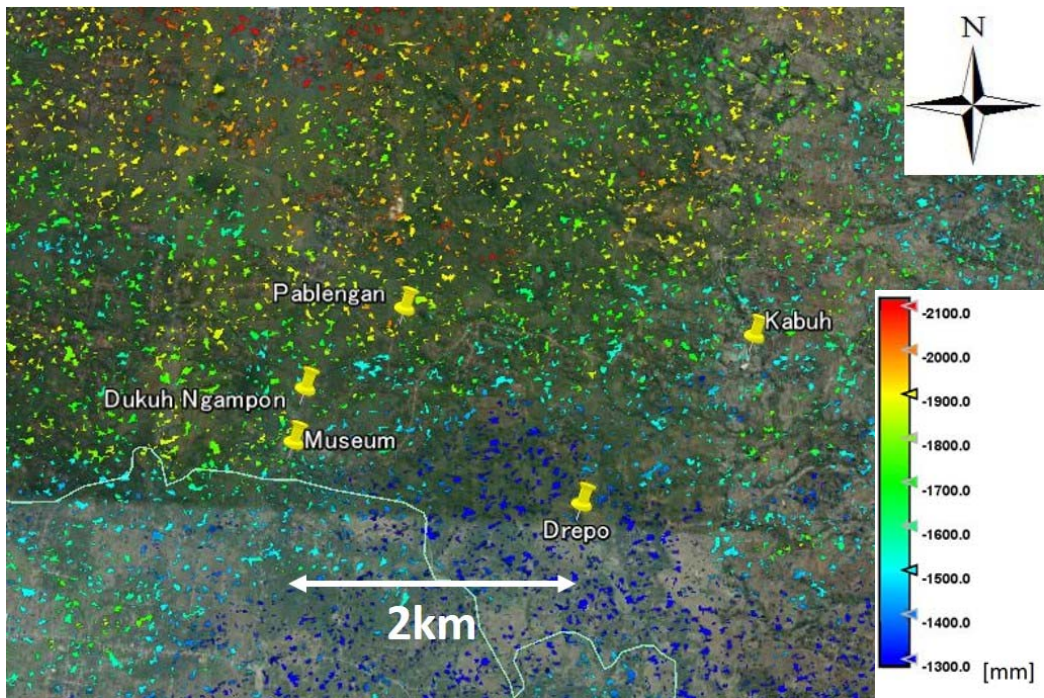

Figure 11. D-InSAR image processing of Sangiran area

## 4. Discussion

As a result, we were able to get the detailed information of an archeological area in Sangiran by small UAV, digital camera and SfM technique. Collected fossils were marked on 3D-model visually. And also, we were able to get the displacement value in

Sangiran area by D-InSAR image processing on SNAP. It can make sure where the most changing for one year is in Sangiran. If we go surveying those areas, new archeological area will be found due to some disaster like landslides. And also the detailed information of those areas will be able to be got by our UAV-SfM technique. So we will have to investigate Sangiran again, especially higher displacement value area, and make sure if D-InSAR image processing result points out our expectative phenomena.

## 5. Conclusion

In this study, the application of the advanced remote sensing for archeology was shown by building 3D-models, making DSM and processing ALOS-2 images. In conventional methods, it took a long time for us to research archeological area and to find new one. This study is expected to define that advanced remote sensing technology will get more effective to research archeological area than the conventional methods.

## Acknowledgements

The author would like to appreciate to Professor Agus Hartoko in Diponegoro University and Professor Josaphat Tetuko Sri Sumantyo in Chiba University for arrangement of the investigation in central Jawa and any supporting. And also, the author would like to thank Achmad Fama in Diponegoro University for supporting when operating the small UAV and giving me some ideas for geology and paleontology.

## References

- 小花和宏之、早川裕式、ゴメス・クリストファー：UAV 空撮と SfM を用いたアクセス困難地の 3D モデリング、Japanese Geomorphological Union、35-3、pp283-294、2014
- 川崎英明、安齋翔次郎、中島宗宏、岡本良夫、小泉俊夫：ブータン伝統住居実測調査での UAV の利用について、写真測量学会平成 26 年度秋季学術講演会発表論文集、pp11-12、2014
- M. Itihara, Sudijono, D. Kadar, T. Shibasaki, H. Kumai, S. Yoshikawa, F. Aziz, T. Soeradi, Wikamo, A.P. Kadar, F. Hasibuan, Y. Kagemori : GEOLOGY AND STRATIGRAPHY OF THE SANGIRAN AREA, QUATERNARY GEOLOGY OF THE HOMINID FOSSIL BEARING FORMATIONS IN JAVA, pp11-27, 1976-1979

---

## **Neutron Radiation To Soft Error Hardened Latches**

Hiroki Ueno, Kazuteru Namba\*

*Graduate School of Advanced Integration Science, Chiba University, 1-33 Yayoi-cho, Inage-ku, Chiba-shi, Chiba, 263-8522 Japan*

---

### **Abstract**

The recent development of semiconductor technology has achieved downsized, large-scaled and low-power VLSI (Very Large-Scale Integration) systems. However, it makes the soft error issue more serious. Soft errors occur due to a transient-induced event caused by striking of high energy neutron radiation from cosmic rays. The striking on the silicon bulk generates electrons and holes, which are collected at a drain node. The collected electrons or holes lead to transient voltage. As a result, values erroneously change in storage elements, such as memory. Traditionally only soft errors on memory system have been serious. However, in recent VLSI systems, soft errors on logic circuit as well as memory system are also serious because recent VLSIs do not tolerate pulses with a short period of time vibration phenomenon. To resolve this issue, researchers (including the authors' group) have presented several soft error tolerate schemes. Most of them provide only simulation results; it is not known that which scheme is best in actual devices. We are making experimentation on an actual device. In this experimentation, several flip-flops are mounted on the actual device; the mounted flip-flops consist of several existing soft error hardened latches, such as DICE, and normal latches not hardened. Neutron beam is delivered to the device. The device is observed by an observation equipment mounted on Raspberry Pi during radiation.

### **Keywords**

**Index Terms—Radiation hardening; soft error tolerance; single event upset (SEU)**

---

## **1. INTRODUCTION**

The recent development of semiconductor technology has achieved downsized, large-scaled and low-power VLSI (Very Large-Scale Integration) systems. However, it makes the soft error issue more serious. The soft error is a transient-induced event on memory and logic circuits caused by striking of  $\alpha$ -rays emitted from the package and high

---

\* Corresponding author. Tel.: +81.43.290.3255; fax: +81.43.290.3305.  
*E-mail address:* [acsa2639@chiba-u.jp](mailto:acsa2639@chiba-u.jp), [namba@faculty.chiba-u.jp](mailto:namba@faculty.chiba-u.jp)

energy neutron radiation from cosmic rays [1], [2], [3].The striking on the silicon bulk generates electrons and holes, which are collected at a drain node. The collected electrons or holes lead to transient voltage [4].

Traditionally only soft errors on memory system have been a serious issue; error-correcting codes have been widely studied and used to tolerate the soft errors. However, in recent VLSI systems, soft errors on logic circuit as well as memory system are also serious issue because recent VLSIs do not tolerate pulses with a short period of time vibration phenomenon [1], [2], [5]. So, several soft error tolerate schemes for logic circuits have been proposed. Logic circuits consist of combinational parts and latches. For errors on combinational parts, several error tolerant schemes have been proposed, e.g. Dual Interlocked storage Cell(DICE) [6], [7], [8], [9], duplication using C-elements[10], [11],duplication using XOR gates [11] and duplicated feedback loop [12].The inter storage cell (DICE)[7]and the latches proposed in [12], [13]have duplicated and interlocking feedback loops and use high impedance states. If particles strike a line on the feedback loops, some lines on the loops become high-impedance states. Despite that, the lines in high-impedance states continue to store correct values using the parasitic capacitance. An S/D latch of [14] uses RC filtering prevents feedback loops from stabilizing erroneous values flipped by particle striking feedback loops. In the SDT latch of [15], the transistors on feedback loops are duplicated to prevent them from incorrectly conducting between the loop and Vss / Vdd.

For errors on latches, several soft error hardened (SEH) latches have been proposed. The Cosmic-Ray immune (CRI) Latch [16] is one of SEH Latches, the CRI latch accomplishes good trade-off between area and error tolerant capability. The evaluation in [16] provides not only simulation results but also results obtained by actual experiments including radiation tests. The results suggest that the latch have a sufficiently high SEU tolerant capability for use in sub-90 nm technologies through they cannot tolerate some errors. The authors group presented soft error tolerant latches allowing enhanced scan delay fault testing by adding transistors to the CRI [16]. The paper [17] presented latches with higher critical charge than [16] by adding transistors to the latches of [16].

This paper presents the background and setup of the experimentation on an actual device. In this experimentation, several flip-flops consisting of the latches: DICE latch, CRI latch, the latch of [14], are mounted on an actual device. Neutron beam is delivered to the device. The device is observed by an observation equipment mounted on Raspberry Pi during radiation; the number of flip-flops in which stored values change due to soft error.

{This paper is organized as follows. Section II introduces related works as preliminaries. Section III provides the construction and features of the proposed latch. Section IV presents the simulation and evaluation results. Finally, Section V concludes the paper.}

## 2. PRELIMINARIES

### 2.1. Soft error

A soft error is a bit upset that is caused by striking of  $\alpha$ -particle and neutron in a circuit. The striking may causes a nuclear reaction at transistors; holes and electrons are generated in the transistor. The generated holes and electrons are accumulated in a drain node, leading an upset. The effect of the upset can be propagated to the whole circuits. A soft error occurs if the charge of the particles is beyond an expected range, called as critical charge. In other words, high critical charge means a high soft error tolerant capability.

The direction of soft errors is determined by types of transistors (NMOS or PMOS) a particle strikes. If a particle strikes a PMOS transistor, it is possible that an error from 0 to 1 occur at the source / drain of the transistor; however errors with the opposite direction (from 1 to 0) never occur at the source / drain. Similarly, if a particle strikes a NMOS transistor, only errors with the direction from 1 to 0 occur at source / drain of transistor.

### 2.2 Soft error hardened latch

Figure 1 shows the construction of normal latch. This latch has two inputs D, CLK and CLKB. D is a normal input. CLK is a clock input and CLKB is an inverted clock input. The latch can store value 1 or 0 and has two states: set and reset. But the normal latch typically does not tolerate soft error.

Here we introduces four conventional soft error tolerant schemes: Cosmic-Ray Immune (CRI) Latch [16], Soft Error Tolerant Latch Allowing Enhanced Scan Delay Fault Testing [17] and Soft Error Tolerant Latch for Enhanced Scan Delay Testing with high critical charge [18]. These latches tolerate soft errors occurring on the latch; errors on combinational parts of logic circuits are not supported.

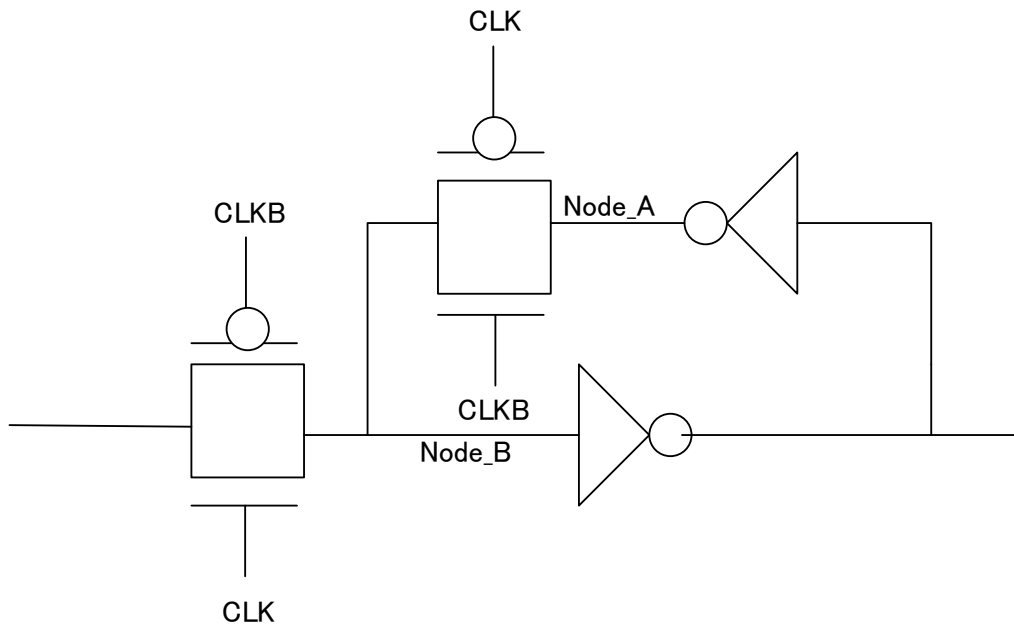

Fig 1. Normal Latch

### 1) *Cosmic-Ray Immune Latch [16]*

Figure 2 shows the construction of the CRI latch [16]. The latch has three inputs D, CK and CKB. D is a normal input. CK is a clock input and CKB is an inverted clock input. The latch has three nodes PDH, NDH and DH to store a value, and two feedback loops, a PDH-DH loop and a NDH-DH loop. The PDH-DH loop passes through PMOS transistors P2, P3 and P6; the NDH-DH passes through NMOS transistors N3, N2 and P6. These two loops keep the same value unless a soft error occurs. PDH is connected to the source / drain of only PMOS transistors P1, P2 and P3: it is not connected to the source / drain of any NMOS transistors. As mentioned in II.A, errors from 1 to 0 never occur at the source / drain of PMOS transistors. So, such errors never occur at PDH. Similarly, NDH is connected to the source / drain of only NMOS transistors N1, N3 and N2. So, errors from 0 to 1 never occur at NDH. DH is connected to the source / drain of both PMOS and NMOS transistors P4, N4, P5, N5, P6 and N6; errors with both direction can occur at DH.

The latch tolerates a soft error on the latch as follow: As mentioned previously, soft errors from 1 to 0 never occur at PDH. If an error from 0 to 1 occurs at PDH, the errors turns P6 off and N2 on. Because P6 turns off, DH is in a high-impedance state transiently; the parasitic capacitance at DH keeps the correct value. Although N2 turns on, this does not affect DH because N3 is in an off-state. In summary, the error is not propagated to DH or NDH. After a while, the flipped value at PDH is dis-charged through P2 and P3, which are controlled by correct values at NDH and DH and are in on-state. Similarly the CRI latch tolerate soft errors occurring at NDH.

Soft errors on DH affect the output node Q because DH is connected to Q through the inverter which consists of P7 and N7. So the value of Q charges to the incorrect one temporarily. In addition it charges the state of P3 and N3. For example the correct value of DH is one, the error turns P3 off and N3 on. However, it does not affect NDH because N2 is in an off-state. The off-state of P3 makes DH be in a high-impedance state transiently; however the parasitic capacitance at DH keeps the correct value. In summary the error does not affect the value of NDH or PDH. Finally, the error is corrected through P6 or N6, which are controlled by correct values at PDH and NDH.

In summary, the CRI is capable of tolerating all possible soft error occurring at single nodes in the latch.

### 2) *Soft Error Tolerant Latch Allowing Enhanced Scan Delay Fault Testing*

Figure3 shows the construction of the latch of [17]. This latch not only tolerates soft errors but also allows enhanced scan testing. We can obtain the latch by adding four transistors P8, P9, N8 and N9 to the CRI latch [16] to achieve enhanced scan design. The latch has two control inputs CNF and CNFB and two scan outputs SCO-PDH and SCO-NDH. The latch supports two operations, namely system and scan-shift operations, which CNF and CNFB controls. If CNF=0 and CNFB=1, the latch does system operations, the latch works in the same way as the original CRI latch. If CNF=1 and CNFB=0, the latch does scan-shift operations. The latch is divided into two latches and works as slave and extra latches of enhanced scan FF. The divided latches cannot tolerate soft errors.

### 3) *Soft Error Tolerant Latch for Enhanced Scan Delay Testing with high critical charge*

Figure4 shows the construction of the latch of [18]. This latch not only tolerates soft errors but also allows enhanced scan testing like [17]. This latch has higher critical charge than [17]. We can obtain the latch by adding four transistors P10, P11, N10 and N11 to the latch of [17], that is, by adding eight transistors P8, P9, P10, P11, N8, N9, N10 and N11 to the CRI latch [16]. The input and output ports are the same as that of [17]; the latch supports enhanced scan testing in the same way as [17].



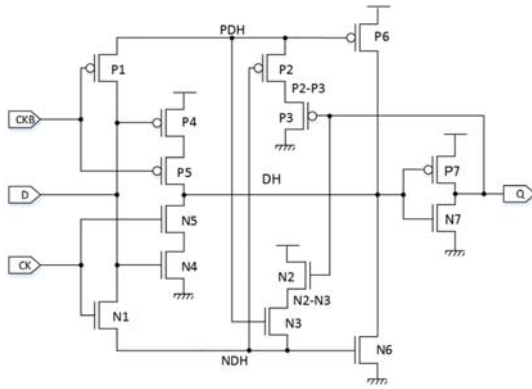

Fig. 2. Cosmic-ray immune (CRI) latch [16].

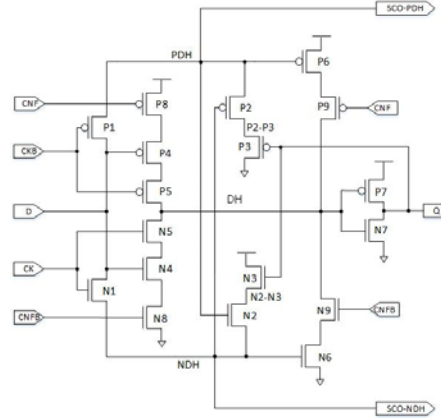

Fig. 3. Soft error tolerant latch allowing enhanced scan delay fault testing [17].

If an error occurs on the CRI latch, DH can be in a high-impedance state. In contrast, DH is always connected to either Vss or Vdd even if a particle strikes at PDH or NDH in the latch of [18]. This property is given by the four additional latches P10, P11, N10 and N11 and accomplishes higher critical charge.

The latch of [18] tolerates soft errors on the latch as follows: PDH is connected to the source / drain of only PMOS transistors, namely P1, P2 and P3. So, errors from 1 to 0 never occur at PDH just like the case of CRI latch. If errors from 0 to 1 occur, it turns P6off, N2 on, and N10 on. The on-state of N2 does not affect NDH because N3 is in an off-state. Just like the CRI latch, P6turns off. However DH is not in a high-impedance state due to the turning on of N10; DH is connected to Vdd because both N10 and N11 are in an on-state. After a while, the flipped value at PDH is discharge through P2 and P3 just like the CRI latch. Similarly the latch of [18] tolerates soft errors occurring at NDH; DH is never in a high-impedance state.

Errors on DH affect the output node Q because DH is connected to Q through the inverter of P7and N7. So, the value of Q changes to the incorrect one temporarily. In addition, it charges the state of P11and N11 as well as P3 and N3. We assume that the correct value of DH is one, the error turns N11 off and P11on. The turning off of N11 does not affect to any nodes because N10 is an off-states. Because P10is an on-state, turning on of P11connects DH to Vss. In the CRI latch, DH is discharged through P2 and P3. In the latch of [18], DH is discharged through P10 and P11 as well as P2 and P3. This gives higher critical charge than the CRI latch.

#### 4) Dual Interlocked storage Cell Latch (DICE Latch)

Figure5 shows the construction of the latch of [7].The latch has short delay time, low power consumption and small area. The latch has three inputs D, CK and CKB. D is a normal input. CK is a clock input and CKB is an inverted clock input. The latch has three nodes net1, net2 and net3 to store a value. All the nodes are connected to the source / drain of both PMOS and NMOS transistors P2, P5, P6, N2, N5 and N6; errors with both direction can occur at the nodes.

The latch tolerates a soft error on the latch as follow: If an error from 0 to 1 occurs at net2, the errors turns P1 off and N3 on. Net 3 is connected to both of Vdd and Vss because N3, N6, P3 and P6 are in an on-state. Net3 store an intermediate value between Vdd and Vss. off, N2 on, and N10 on. Net1 is not affected because P1 is in an off-state. After a while, the flipped value at Net2 is dis-charged through N2, which are controlled by

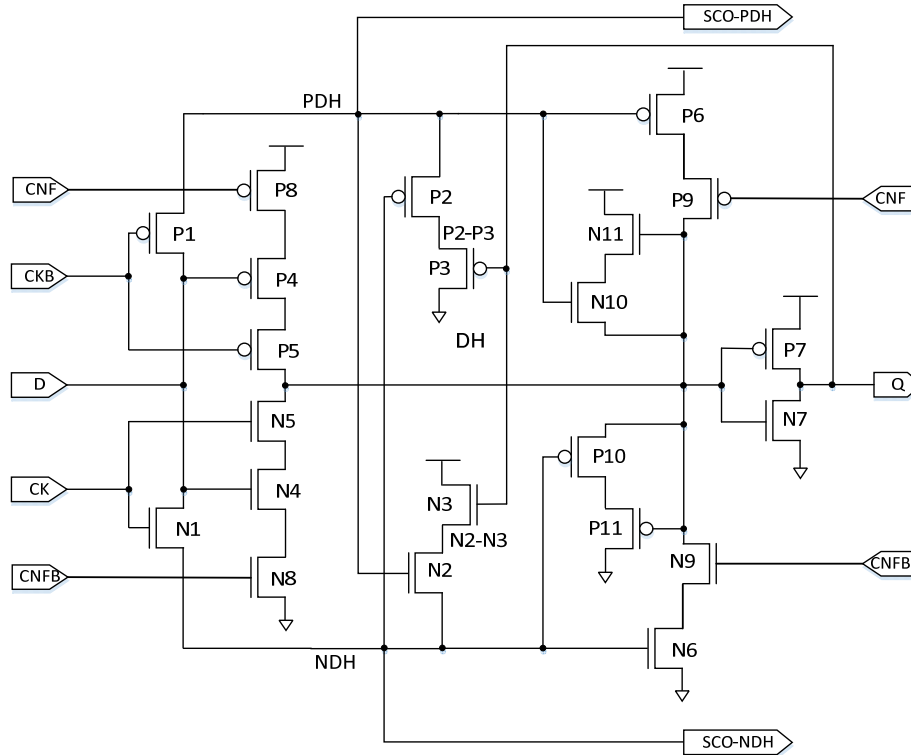

Fig. 4. Soft Error Tolerant Latch for Enhanced Scan Delay Testing with high critical charge [18].

correct values at net1 and are in on-state. Net1 and Net3 tolerate soft error in the same way as net2.

### 3. SIMULATION

To estimate soft error tolerant capability of these latches, we performed simulations using HSPICE and Predictive Technology Model (PTM) [19]. Experimentation is performed at room temperature 25 degrees C.

Table 1 shows the critical (i.e. maximum) charge (fC) of particles which each latch can tolerate for nodes PDH. PDH has the lowest critical charge for any latches. This result gives evidence that the latch of [18] has the best soft error tolerant capability (i.e. the highest critical charge) in the three latches. The CK-Q delay time of the three latches is shown in Table 1. The delay time of the normal latch is the shortest in these latches. The average of the peak power consumption for the rising and falling edge of Yang FF is the lowest in these latches.

### 4. EXPERIMENTATION SPECIFICATION

For the radiation experiment, we designed an actual device. Fig.6 shows the layout of the actual device. In this time, experimentation are performed for three flip-flops: Normal flip-flop, Yang flip-flop and DICE flip-flop. We construct these flip-flop at 180 nm. The power supply from Raspberry Pie 3 is 3.3 V. We will perform radiation test once for two hours.

Fig7. Illustrate the outline of the experimentation environment. The actual device is connected to a test equipment which is designed on Raspberry Pie 3. All the three FF

output a value after six clock rising edge. Normal flip-flop is constructed by three master slave flip-flop. The MS-FF has two normal latches. The Yang flip-flop is constructed by three MS-FF too. The MS-FF has CRI latch as master latch and the latch of [18] as slave latch. DICE flip-flop is constructed by three MS-FF. The MS-FF has two DICE latches.

## 5. CONCLUSION

This paper presented preliminaries and specifications of the neutron radiation to soft error hardened latches. The soft error is a transient-induced event on memory and logic circuits caused by striking of high energy neutron radiation from cosmic rays. However, evaluations in many papers provides not only simulation results but also results obtained by actual experiments including radiation tests. To confirm the validity of the simulation results, we are making experimentation on an actual device.

## ACKNOWLEDGMENT

This work was supported by VLSI Design and Education Center (VDEC), the University of Tokyo in collaboration with Synopsys, Inc, Cadence Design Systems, Inc, Mentor Graphics, Inc, Rohm Corporation and Toppan Printing Corporation.

TABLE1  
The critical Charges (fC) of particles, Delay time (ps) and dynamic power (uW) of the three latches

	normal	dice	yang1
qcrit(fQ)	9	30	99
delay(ps)	14.21	21.21	38.13
power_rise(uW)	522	576	510
power_fall(uW)	528	601	487

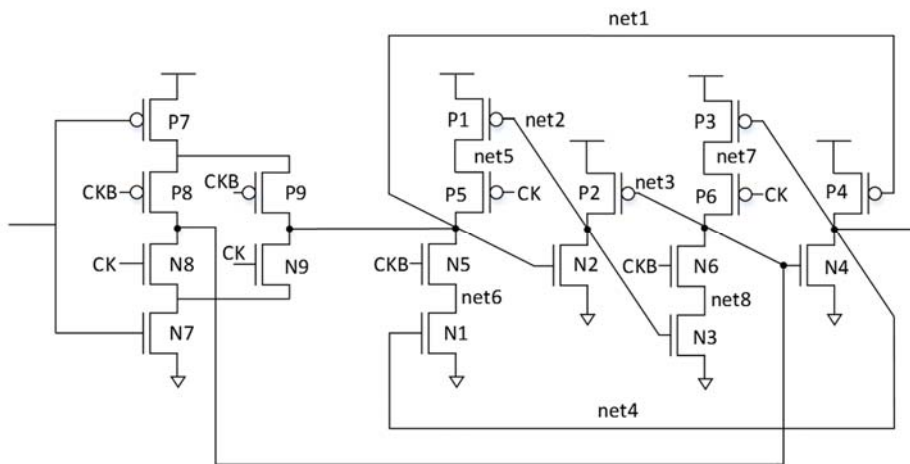
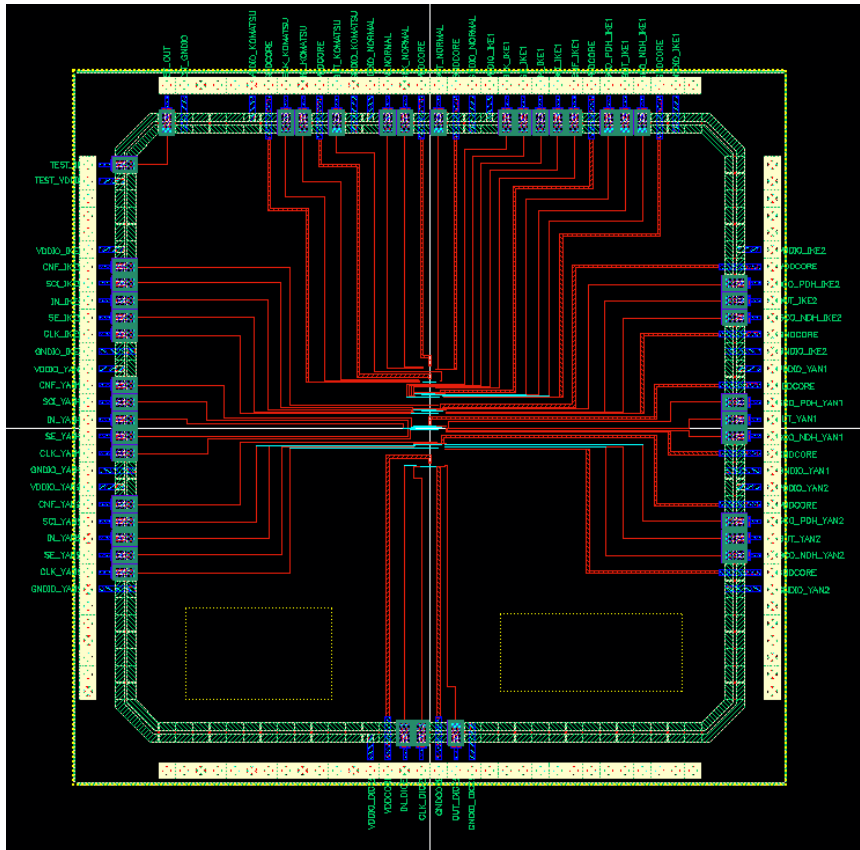
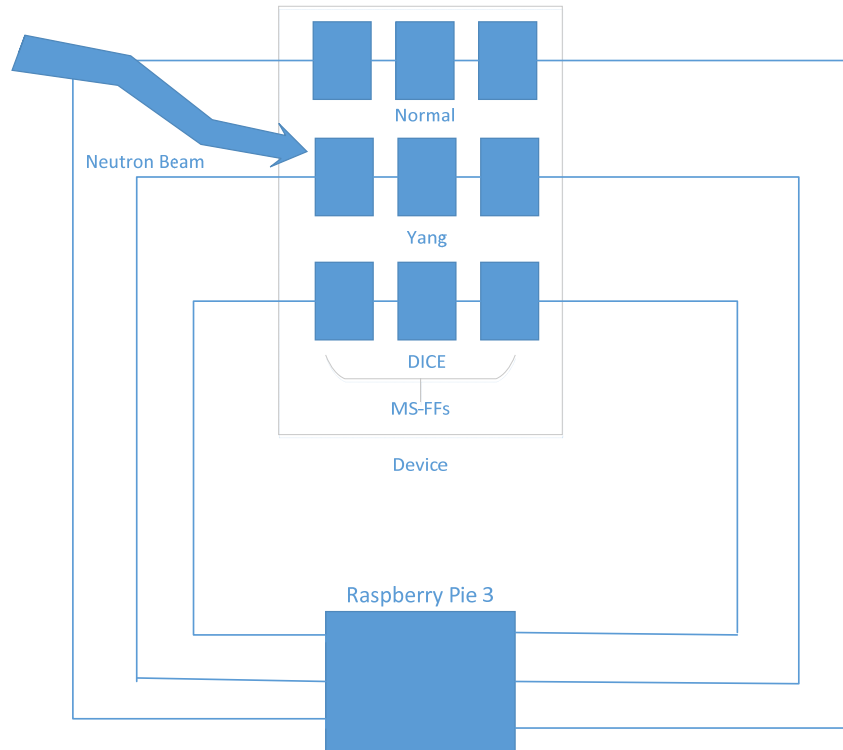

Fig. 5. DICE latch



**Fig 6.**  
Layout of the actual device



**Fig 7.**  
Test equipment

## References

- [1] S. Mitra, N. Seifert, M. Zhang, Q. Sbi and K.S. Kim, "Robust system design with built-in soft-error resilience," *IEEE Des. & Test Comput.*, pp.43--52, Feb. 2005.
- [2] T. Karnik, P. Hazucha and J.Patel, "Characterization of soft errors caused by single event upsets in CMOS processes," *IEEE Trans., Dependable & Secure Comput.*, vol.1, No.2, pp.128--143, 2004.
- [3] L.-T. Wang, C.-W. Wu and X. Wen, *VLSI test principles and architectures: design for testability*, Morgan Kaufmann, 2006.
- [4] N. Bidokhti, "SEU concept to reality (allocation, prediction, mitigation)," *Reliability and Maintainability Symp*, 2010 proceedings - Annual. 2010
- [5] P. Shivakumar, M. Kistler, S.W. Keckler, D. Burger and L. Alvisi, "Modeling the effect of technology trends on the soft error rate of combinational logic," *Proc. IEEE Int'l Conf. Dependable Syst. & Networks*, pp.389--398, 2002.
- [6] D.R. Blum, M.J. Myjak and J.G. Delgado-Frias, "Enhanced fault-tolerant data latches for deep submicron CMOS," *Proc. IEEE Int'l Conf. Comput. Des.*, pp.28--34, 2005.
- [7] T. Calin, M. Nicolaidis and R. Velazco, "Upset hardened memory design for submicron CMOS technology," *IEEE Trans. Nuclear Sci.*, Vol.43, No.6, pp.2874--2878, Dec., 1996.
- [8] R. Naseer and J. Draper, "The DF-DICE storage element for immunity to soft errors," *Proc. 48th Int'l Midwest Symp. Circuit Syst.*, pp.303--306, 2005.
- [9] R. Naseer and J. Draper, "DF-DICE: A scalable solution for soft error tolerant circuit design," *Proc. IEEE Int'l Symp. Circuits Syst.*, pp.3890--3893, 2006.
- [10] A. Goel, S. Bhunia, H. Mahmoodi and K. Roy, "Low-overhead design of soft-error-tolerant scan flip-flops with enhanced-scan capability," *Proc. Des. Automation Asia South Pacific Conf.*, pp.665--670, 2006.
- [11] S. Mitra, M. Zhang, S. Waqas, N. Seifert, B. Gill and K.S. Kim, "Combinational logic soft error correction," *Proc. IEEE Int'l Test Conf.*, pp.824--832, 2006.
- [12] M. Omana, "Novel transient fault hardened static latch," *Proc. IEEE Int'l Test Conf.*, pp.886--892, 2003.
- [13] L. R. Rockett, Jr, "An SEU-hardened CMOS data latch design," *IEEE Trans. Nucl. Sci.*, vol. 35, pp. 1682-1687, Dec. 1988.
- [14] T. Monnier, F.M. Roche, J. Cosculluela, and R. Velazco, "SEU testing of a novel hardened register implemented using standard CMOS technology," *IEEE Trans. Nucl. Sci.*, vol. 46, no. 6, pp. 1440-1444, Dec.1999.
- [15] Y. Zhao and S. Dey, "Separate dual-transistor registers—A circuit solution for on-line testing of transient error in UDSM-IC," in *Proc. IEEE Int. On-Line Test. Symp.*, 2003, pp. 7-11.
- [16] Y. Komatsu, Y. Arima, T. Fujimoto, T. Yamashita and K. Ishibashi, "A soft-error hardened latch schemes for SoC in a 90nm technology and beyond," *Proc. IEEE Custom Integr. Circuit Conf.*, pp.324--332, 2004.
- [17] K. Namba, T. Ikeda and H. Ito, "Construction of SEU Tolerant Flip-Flops Allowing Enhanced Scan Delay Fault Testing, " *IEEE Trans. Very Large Scale Integr. Syst.*, Vol. 18, No. 9, pp. 1265-1276, Sep. , 2010.
- [18] Y. Lu, F. Lombardi, S. Pontarelli and M. Ottavi, "Design and Analysis of Single-Event Tolerant Slave Latches for Enhanced Scan Delay Testing, " *IEEE Trans. Device Mater. Reliab.*, vol. 14, No. 1, pp 333-343, Mar. 2014.
- [19] [Online]. Available: <http://ptm.asu.edu/>

The Effectiveness Of Addition Nelson Traction On Microwave Diathermy (MWD) Intervention And Transcutaneous Electrical Stimulation (TENS) For Upper Thoracal Joint Blockade Pain Reduction.

Susana<sup>a</sup>, Agus Hendra Wahyudi

<sup>a</sup>alumni student at Fisioterapi Indonesia Esa Unggul, Kebun Jeruk Jakarta 11510, Indonesia

<sup>b</sup>Josaphat Microwave Remote Sensing Laboratory, Center for Environmental Remote Sensing, Graduate School of Advance Integration Science, Chiba University, 1-33, Yayoi, Inage, Chiba, 263-8522, Japan

---

Abstract

This research aims to determine the effect of Nelson Traction combined with the provision MWD and TENS on pain reduction upper thoracal result of joint blockade. The sample of 10 people who were divided into age and gender were used in this research. This study was quasi experimental in the treatment compare before and after therapy MWD+TENS+Nelson Traction. Measuring tool used was Visual Analogue Scale (VAS). The effect therapy was reduced blood circulation, relaxation of muscle, pain reduction in the level of sensory, spinal level and in the supra spinal level and also obtained another effect that was opening joints that locked, restore nucleus anteriorly, stretching muscles and ligaments, widening the intervertebral foramen, and reduced disruption of respiration especially during inspiration. Statistical data were processed and analysed by wilcoxon match pairs and Mann-Whitney method by SPSS software tools. There was found that the pain were reduced significantly between before and after intervention reach to 26.70 VAS and P value 0,005 (P < 0,05).

Keywords

Nelson Traction, Joint Blockade, pain, MWD, TENS

1. INTRODUCTION

According to Rene Caillet 80 % population had never felt pain throughout their lives regardless of gender, age, social level, and the profesi. In his book Mc. Kenzie said the back pain is divided into upper back pain and lower back pain. Judging the aspects of biomechanics. The cause of back pain is divide into errors postural in the long term and kinetic back pain is pain that arises due to abnormalities or errors postural can be experience by anyone for example a student who has habit of writing by means of bending his back, a man who worked at in front of the computer by means of bending caused due to the high table computer that does not comply with chairs.

Based on the declaration of WCPT (World Confederation Physical Therapy) in Yokohama, physiotherapy is integral part of the health care profession which are addressed to individuals and groups to development, maintainance, and restore movement and fuction of the body throughout their life cycle of using techniques MWD,SWD,TENS,IIR, ULTRA SOUND, Massage, exercise therapy, and manipulation methode such as Nelson Traction.

Some cases of back pain also combine with joint blockade which is needed to release back with manual therapy. In this research we will focus on addition of manual therapy Nelson Traction Methode effectiveness in reduction of back pain and combine this methode with MWD - TENS therapy.

## 2. THEORY

Back pain is a pain in the back. Episodes of back pain may be acute, sub-acute, or chronic depending on the duration. The pain may be characterized as a dull ache, shooting or piercing pain, or a burning sensation. The pain may radiate into the arms and hands as well as the legs or feet, and may include paresthesia (tingling with no apparent cause), weakness or numbness in the legs and arms. The anatomic classification of back pain follows the segments of the spine: neck pain (cervical), middle back pain (thoracic), lower back pain (lumbar) or coccydynia (tailbone or sacral pain) with the lumbar vertebrae area most common for pain and some times can be difficult to breath.

### 2.1 Anatomy and Fisiology Of Trunk

The totally of trunk is described in figure 1 which consist of 33 bones, particularly cervikal 7, thoracal 12, lumbal 5, sacral 5, cocygeus 4-5 bones.

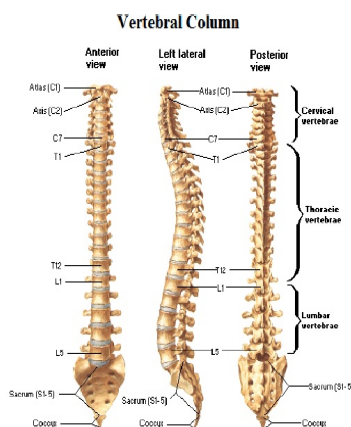

Figure 1. Human's trunk anatomy

The trunk work as stabilizers of body and there is many muscles in the trunk.

## 2.2 Facet Joint Anatomy

The facet joints are paired joints in the back and neck, one pair at each vertebral level (one joint on each side of the vertebrae). These joints have opposing surfaces of cartilage (cushioning tissue between the bones) and a surrounding capsule that is filled with synovial fluid, which reduces the friction between bones that rub together.

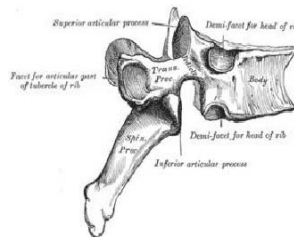

Figure 2. Facet Joint Anatomy

## 2.3 Joint Blockade on Thoracal Joint

At one the time a joint occur locking is a condition that occurs in the joint that have a meniscus uch as the spinal facet joint. In this research about joint blockade in facet processus transversus inferior cervical 7 and facet precesesus tranversus superior in thorakal 1 until thoracal 12.

Joint blockade will occur cause poor postur, antero postero cercical, kiphosis . *Thoracic facet joints.* pain caused by thoracic facet joints (in the upper spine) is typically felt in the upper back, chest, and/or arm (rarely).

How to know the joint is blockade? there is special exmination to know it. It's examination is PACVP (Postero Anterior Central Vertebral Pressure). If there is hurt when PACVP done and the pysical therapis feel firm end feel in the last examination it positif joint blockade.

## 2.4 Visual Analogue Scale (VAS)

VAS is measuring the intensity and type of pain, with use line 10 cm to describe intensity of pain. It's start zero pain, middle pain, and sore pain.

## 2.5 Micro Wave Diathermy (MWD)

It's a therapy method to use stressor fisis electromagnetic resulting from current frecuency 2450MHz with waves lengths 12,25cm.

## 2.6 TENS

Transcutaneous Electrical Nerve Stimulation (TENS) it's one of therapy method that use electricity in stimulation nerve sensori and it will reduce pain through gate control theory.

TENS has the form of monophasic, biphasic, and polyphasic. Monophsic has the form retrangular, trianguler, and half sine wave in the direction of the biphasic while



in the polyphasic pattern there is a series of sine waves and the form of interference or mixed.

#### 2.7. Nelson Traction

It's manipulation method which use to open facet joint locked. The effect of therapy can open joints that locked, restore nucleus anteriorly, stretching muscles and ligaments, widening the intervertebral foramen, and reduced disruption of respiration especially during inspiration.

### 3. METHODE

This Research metode utilize quasi experimental and Statistical data was processed and analysed by wilcoxon match pairs and Mann-Whitney method, compare before and after therapy MWD+TENS+NELSON TRACTION, and calculation with SPSS 2000 program. This research have been done in Navy Hospital Mintohardjo West Jakarta.

### 4. RESULT AND ANALYSIS

This research implement on 10 person consist of 2 men and 8 women. Below table 1 show distribution of sample by gender.

Tabel 1. Distribution sample by gender

Gender	Sample	P
	N	%
Man	2	20
Woman	8	80
Totally	10	100

While sample distribution by age is described in table 2.

Tabel 2. Distribution sample by Age

Age (Years)	Sample	P
	N	%
20-27	1	10
28-35	2	20
36-43	3	30
44-51	3	30
52-58	1	10
59-65	0	0
Totally in persen	10	100%

After being given MWD+TENS+Nelson Traction therapy there were reduction pain result on thoracal joint because of joint blockade. The result can be seen in table 3.

Tabel 3. Relief of pain before and after therapy

Sample	Before	After	Change
1	50	3	47
2	55	28	27
3	39	16	23
4	48	46	2
5	58	25	33
6	39	35	4
7	62	39	23
8	50	20	30
9	90	24	66
10	51	39	1
Mean	54,20	27,5	26,70
SD	14,543	12,782	19,368

Statistical data were processed and analysed by wilcoxon match pairs and Mann-Whitney method. There were found that the pain were reduced significantly between before and after intervention reach to 26.70 VAS and P value 0,005(P <0,05).

## 5. CONCLUSION

There were some positif change effect therapy MWD+TENS+NELSON TRACTION before and after intervention to reduce pain caused by joint blockade upper thoracal with reach to 26.70 VAS and P value 0,005(P <0,05).

## REFERENCES

Atkinson, Karen, et al (1999), *Physiotherapy in Orthopaedics A Problem-Solving Approach*, Churchill Livingstone, London.

Donatelli, Robert, and Wooden, Michael J, (1989), *Orthopaedic Physical Therapy*, Churchill Livingstone, New York.

Kisner, Carolyn, and Colby, Lynn Allen (1996), *Therapeutic Exercise Foundations and Technique*, Third Edition, F.A. Davis Company, Philadelphia.

Low, John, and Reed, Ann (2000). *Electrotherapy Explained Principles and Practice*, Third Edition, Butterworth Heinemann, Oxford.

Low, John & Dyson, et al (2000). *Electrotherapy Explained principles and practice*, Ed. III, Oxford, Auckland, Boston, Johannesburg, Melbourne, New Delhi.

# The Indonesia Japan Joint Scientific Symposium

Established in 2004, IJSS is the premier event in the collaboration between Indonesia University (UI) and Chiba University. The 1st The Indonesia Japan Joint Scientific Symposium (IJSS 2004) was held in 2004 at Chiba University, Japan. The 2nd IJSSS was held at Universitas Indonesia, Jakarta, Indonesia on 6-8 September 2006. The 3rd IJSS was held at Chiba University on 9-11 September 2008. The 4th IJSS was held at Universitas Udayana, Bali, Indonesia on 29 September – 1 October 2010. The 5th IJSS was held at Chiba University, Japan on 25-28 October 2012. The 6th IJSS was held at Universitas Gadjah Mada, Indonesia on 28-30 October 2014. The 7th IJSS will be held at Keyaki Kaikan (University Convention Hall), Nishi Chiba Campus of Chiba University, Japan on 20-24 November 2016.



1-33 Yayoi, Inage, Chiba, 263-8522  
Tel: +81-(0)43-251-1111  
Website <http://www.chiba-u.jp>

## Supported by:



## Sponsored by:

