

LAMPIRAN

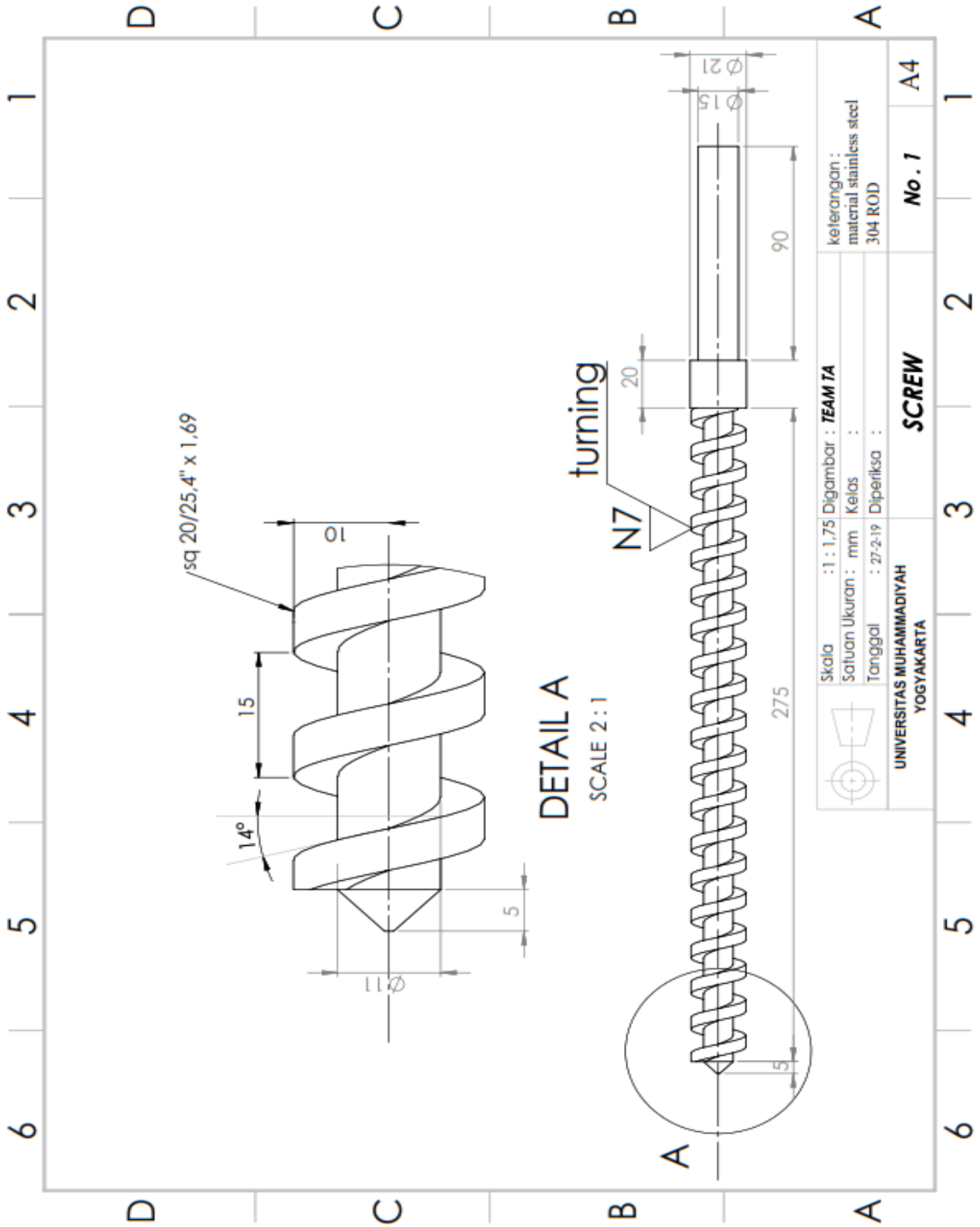

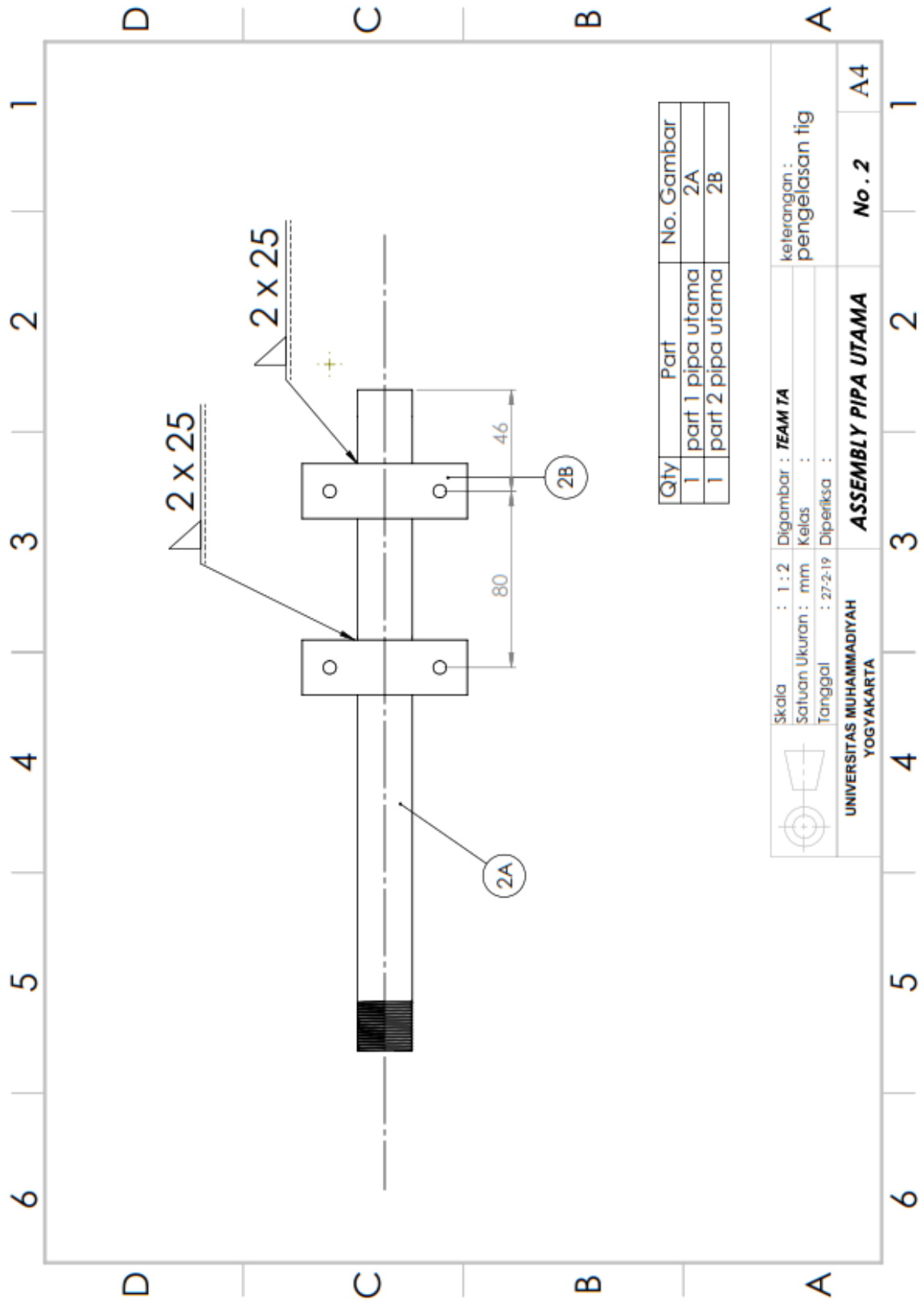

Qty	Part	No. Gambar
1	part 1 pipa utama	2A
1	part 2 pipa utama	2B

	Skala : 1 : 2	Digambar : TEAM TA	keterangan : pengelasan tig
	Satuan Ukuran : mm	Kelas :	
	Tanggal : 27-2-19	Diperiksa :	
UNIVERSITAS MUHAMMADIYAH YOGYAKARTA		ASSEMBLY PIPA UTAMA	No . 2
4	3	2	A4

6 5 4 3 2 1

6 5 4 3 2 1

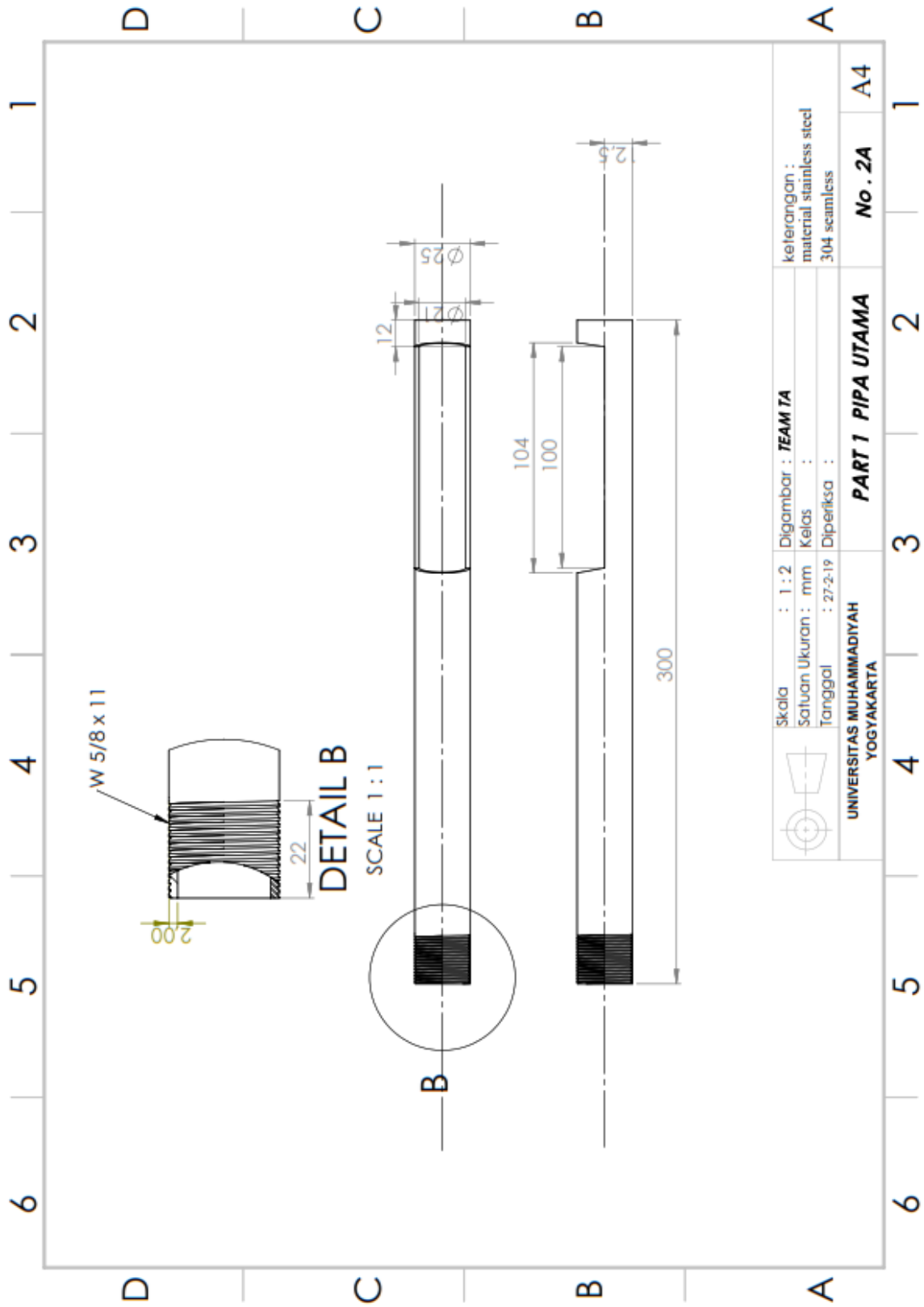

	Skala : 1 : 2	Digambar : TEAM TA	keterangan :
	Satuan Ukuran : mm	Kelas :	material stainless steel
	Tanggal : 27-2-19	Diperiksa :	304 seamless
UNIVERSITAS MUHAMMADIYAH YOGYAKARTA		PART 1 PIPA UTAMA	No . 2A
			A4

1 2 3 4 5 6 1 2 3 4 5 6

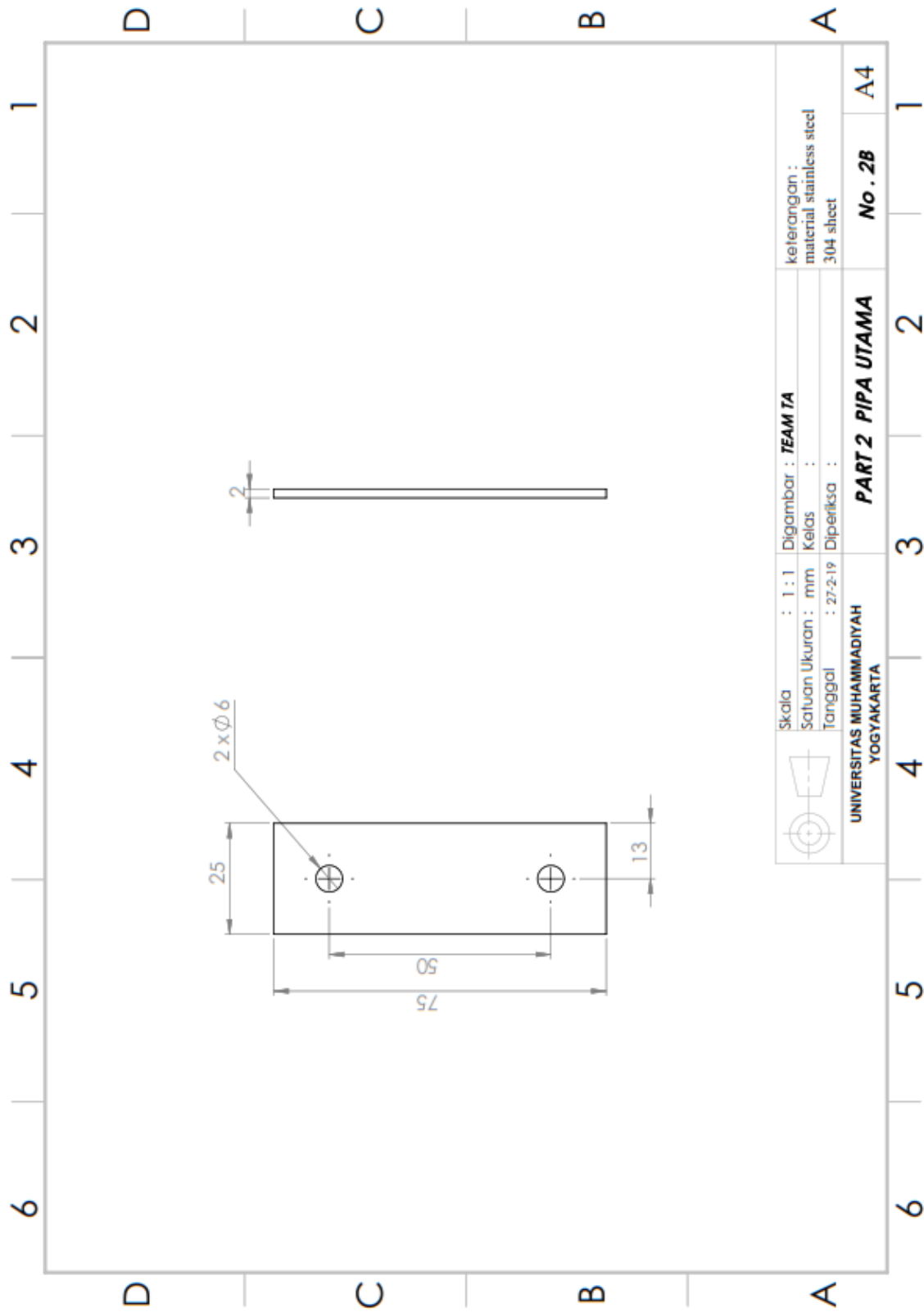

	Skala : 1 : 1	Digambar : TEAM TA	keterangan : material stainless steel 304 sheet
	Satuan Ukuran : mm	Kelas :	
	Tanggal : 27-2-19	Diperiksa :	
UNIVERSITAS MUHAMMADIYAH YOGYAKARTA		PART 2 PIPA UTAMA No . 2B	

A4

1

2

3

4

5

6

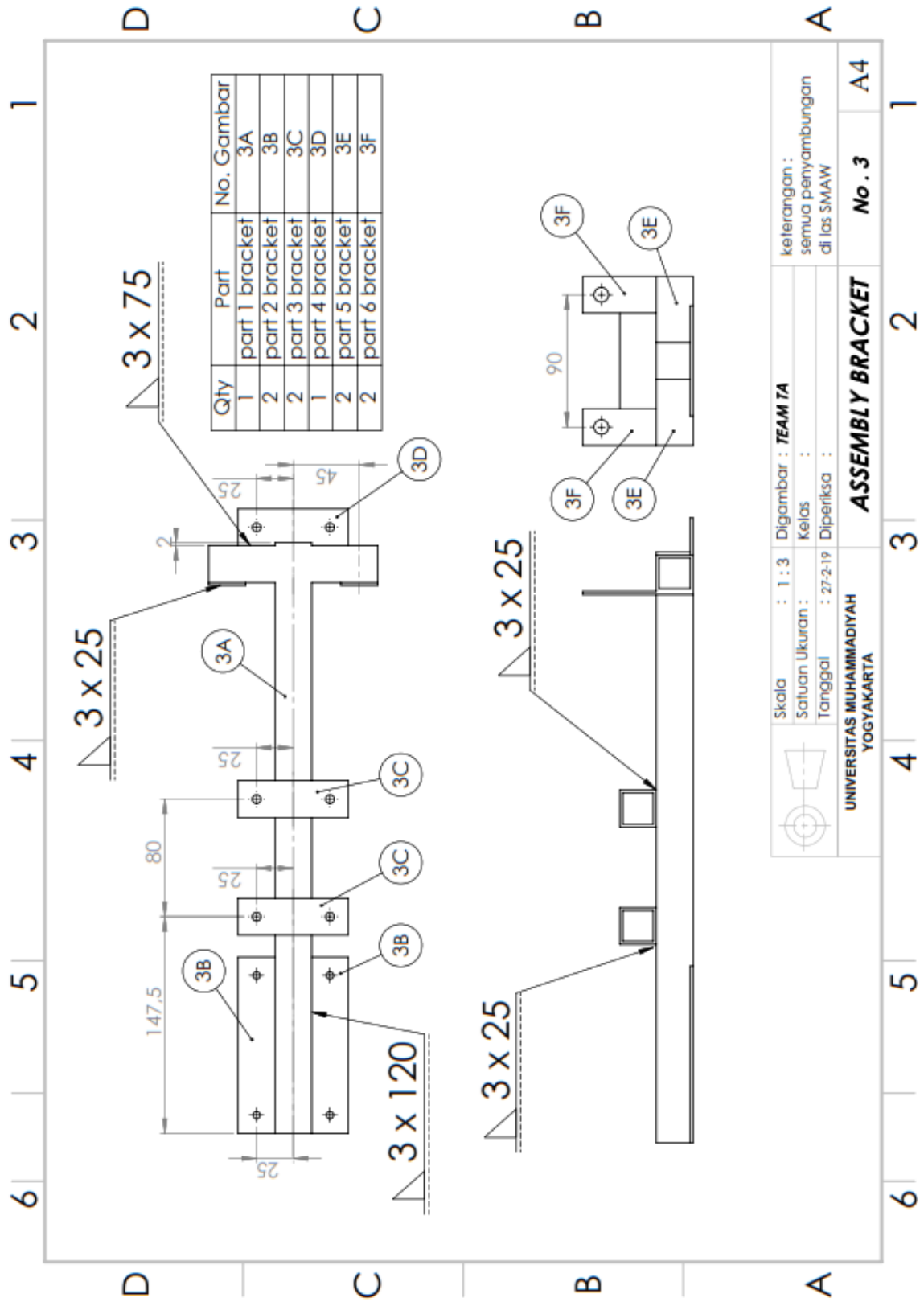

	Skala : 1 : 3	Digambar : TEAM TA	keterangan : semua penyambungan di las SMAW
	Satuan Ukuran :	Kelas :	
	Tanggal : 27-2-19	Diperiksa :	
UNIVERSITAS MUHAMMADIYAH YOGYAKARTA		ASSEMBLY BRACKET	
		No . 3	A4

6 | 5 | 4 | 3 | 2 | 1

A | B | C | D

6 | 5 | 4 | 3 | 2 | 1

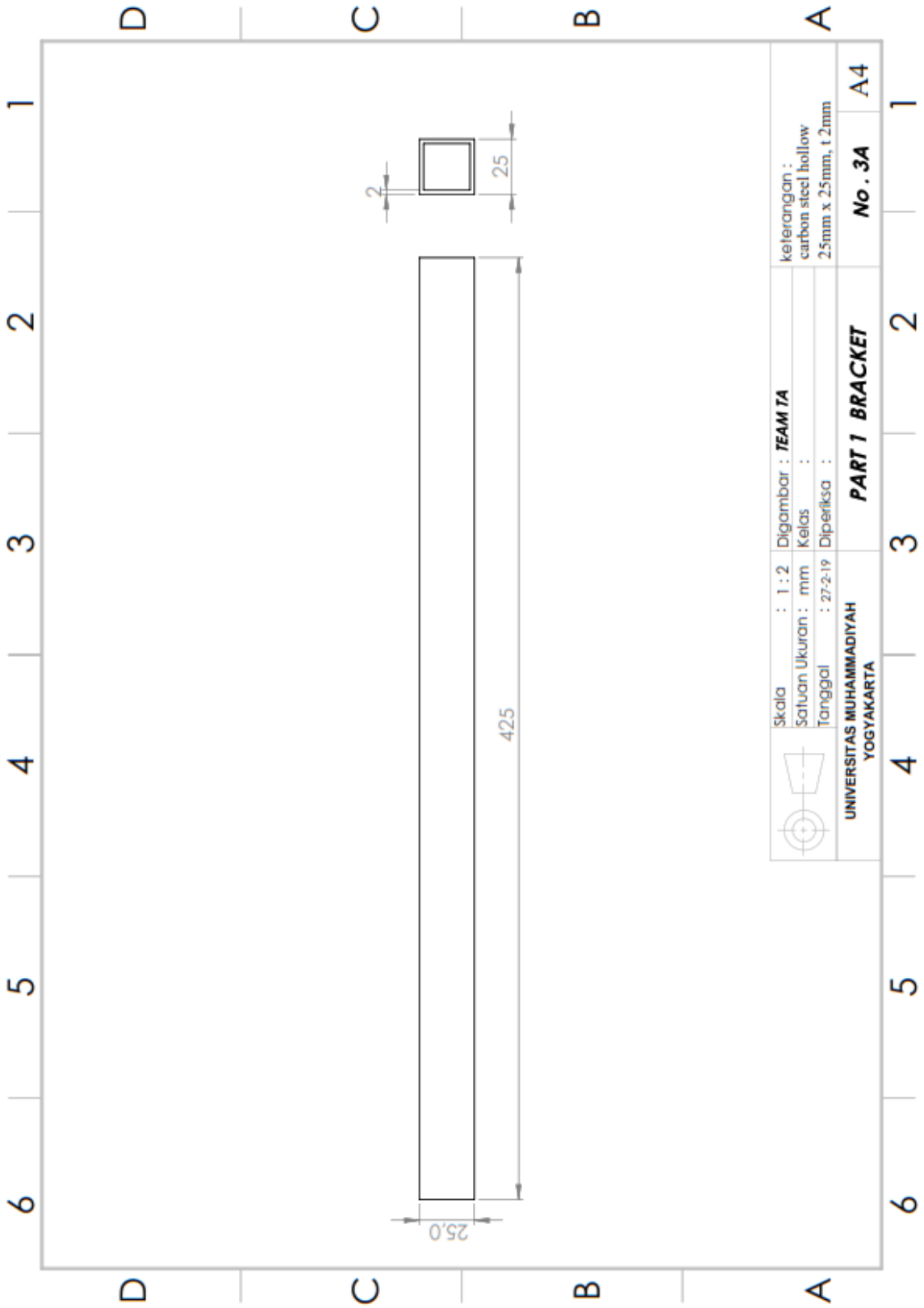

 UNIVERSITAS MUHAMMADIYAH YOGYAKARTA	Skala : 1 : 2	Digambar : TEAM TA	keterangan : carbon steel hollow 25mm x 25mm, t 2mm
	Satuan Ukuran : mm	Kelas :	
	Tanggal : 27-2-19	Diperiksa :	
PART 1 BRACKET			No . 3A
			A4

6 5 4 3 2 1

6 5 4 3 2 1

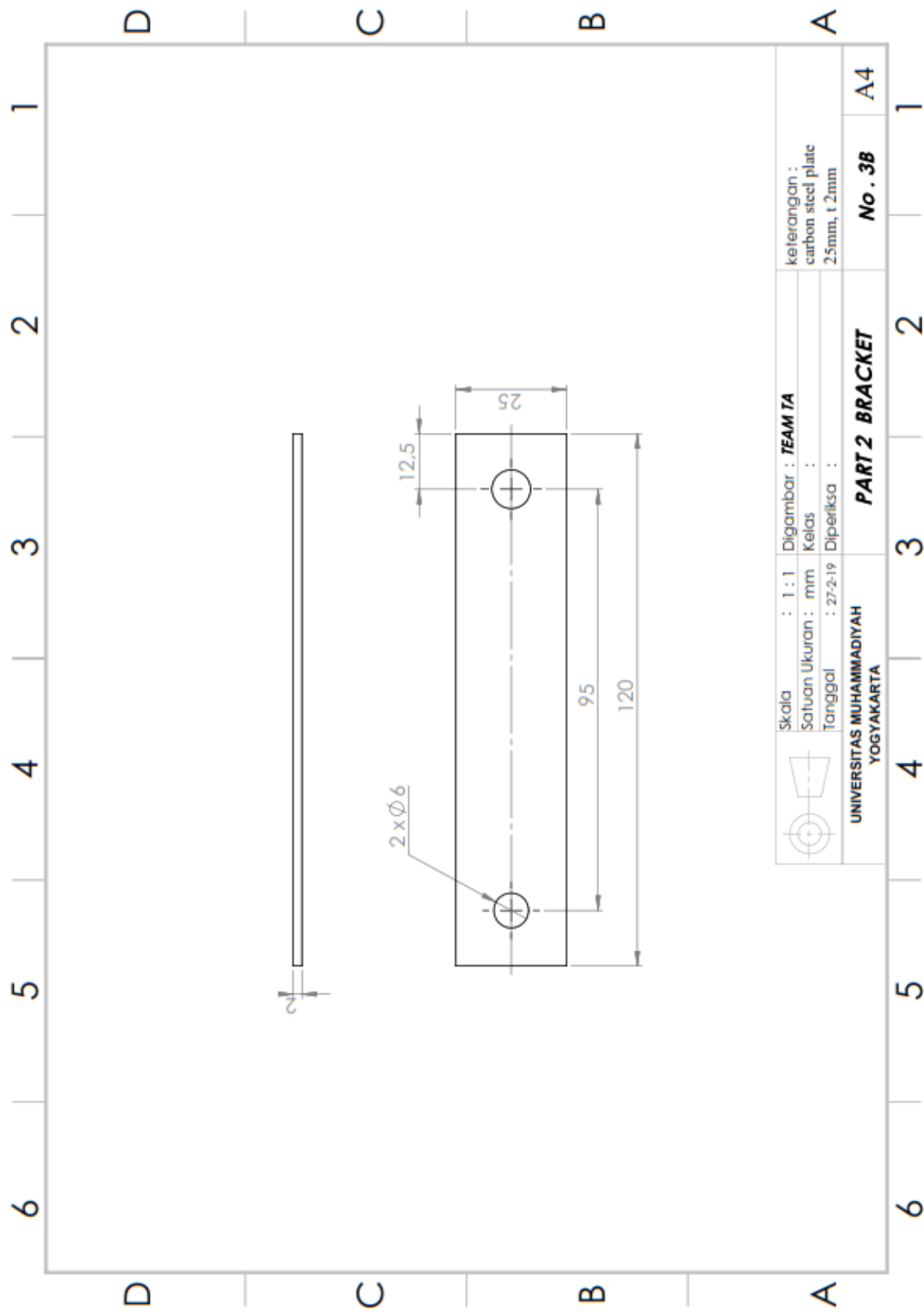

 UNIVERSITAS MUHAMMADIYAH YOGYAKARTA	Skala : 1 : 1	Digambar : TEAM TA	keterangan : carbon steel plate 2.5mm, t 2mm
	Satuan Ukuran : mm	Kelas :	
	Tanggal : 27-2-19	Diperiksa :	
PART 2 BRACKET		No . 3B	A4

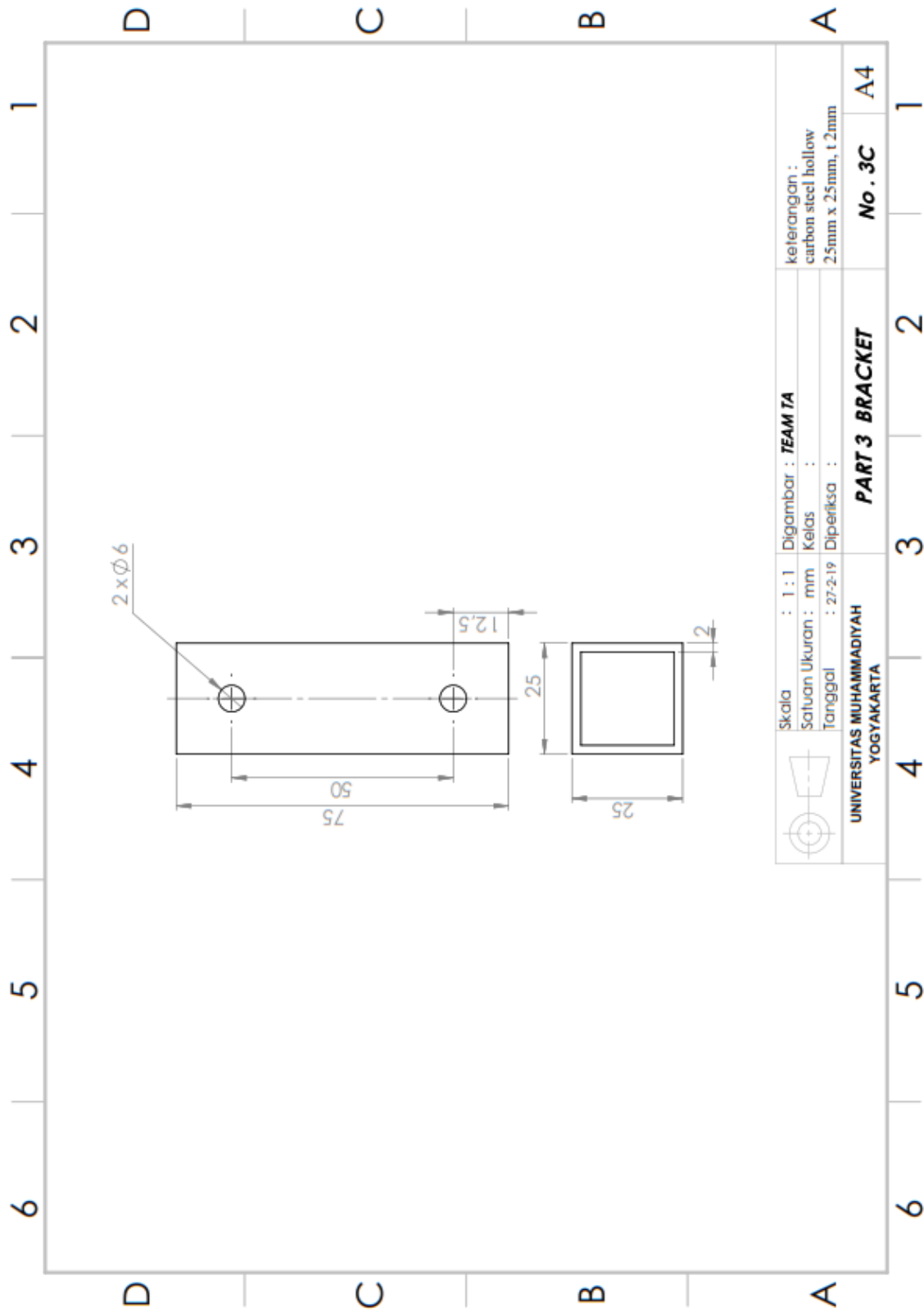

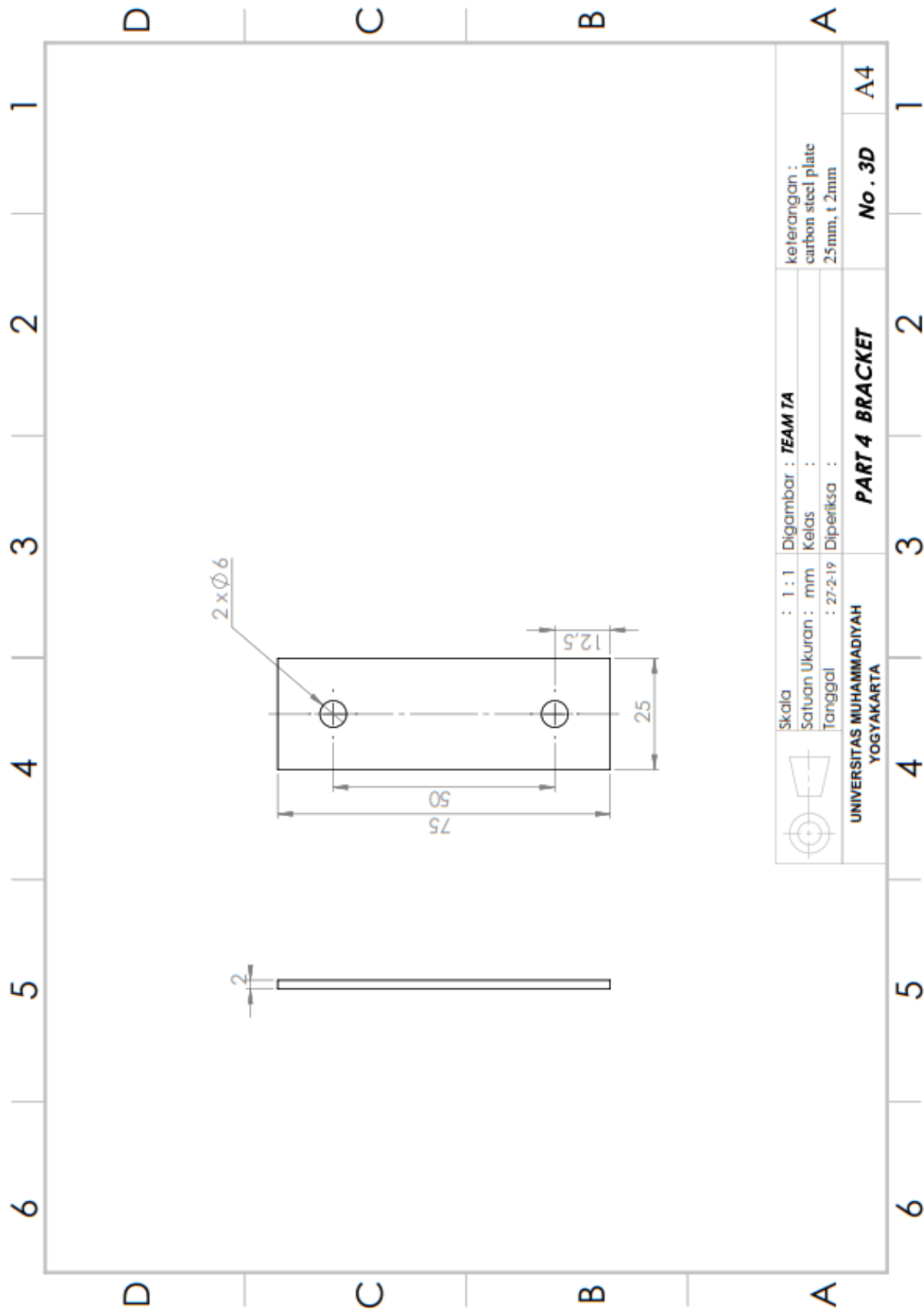

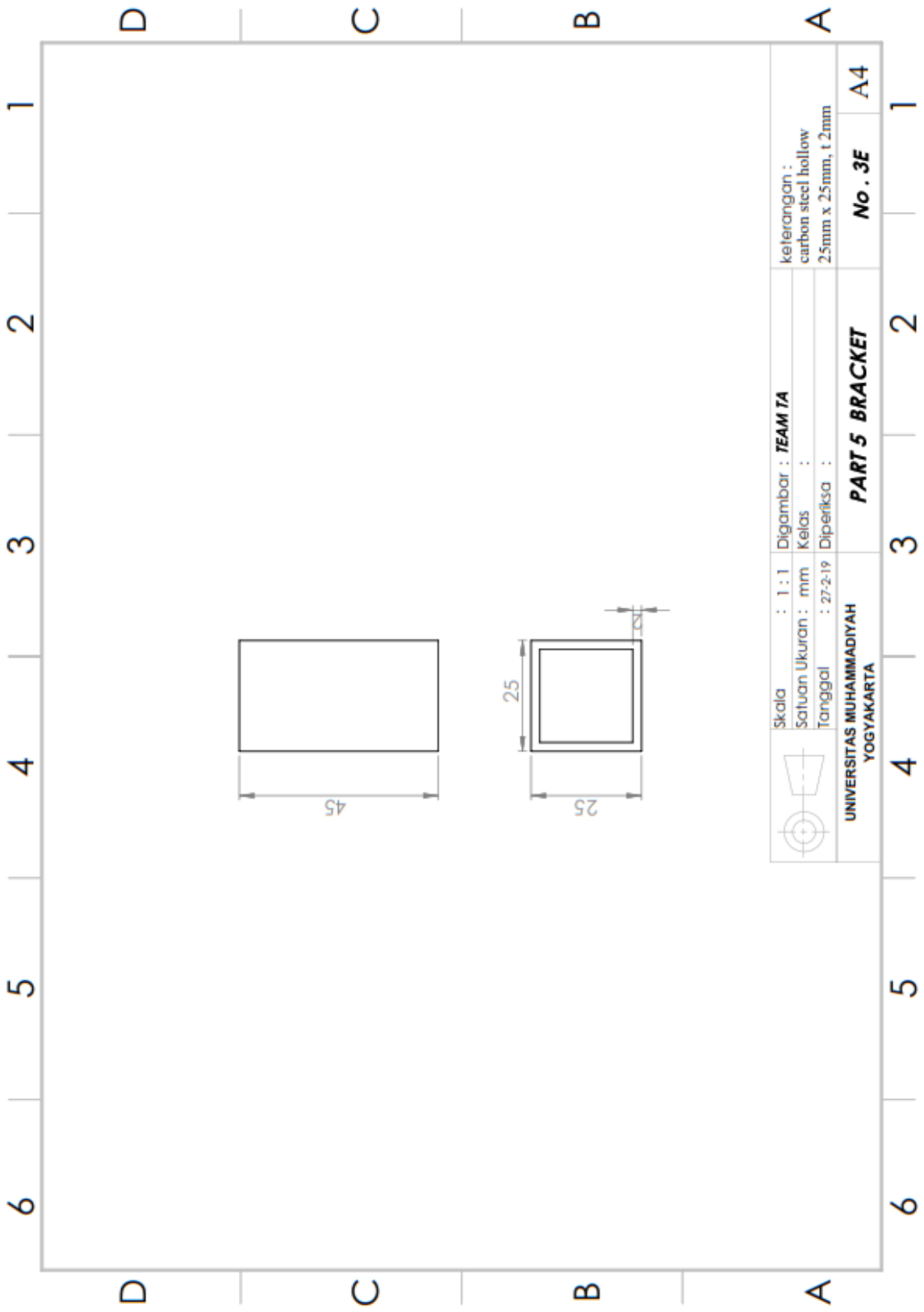

	Skala : 1 : 1	Digambar : TEAM TA	keterangan : carbon steel hollow 25mm x 25mm, t 2mm	
	Satuan Ukuran : mm	Kelas :		
	Tanggal : 27-2-19	Diperiksa :		
UNIVERSITAS MUHAMMADIYAH YOGYAKARTA		PART 5 BRACKET	No . 3E	A4

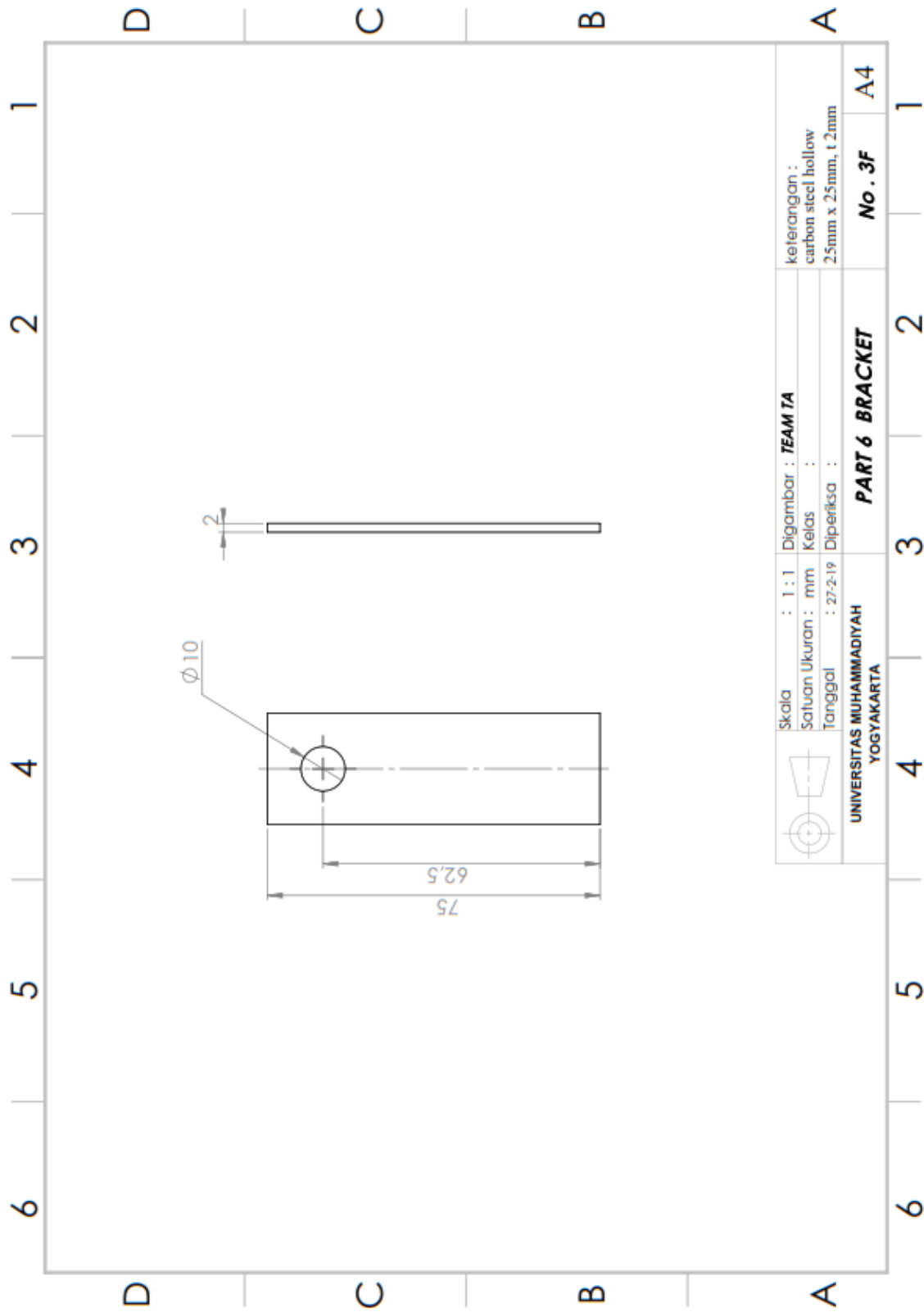

	Skala : 1 : 1	Digambar : TEAM TA	keterangan : carbon steel hollow 2.5mm x 25mm, t 2mm
	Satuan Ukuran : mm	Kelas :	
	Tanggal : 27-2-19	Diperiksa :	
UNIVERSITAS MUHAMMADIYAH YOGYAKARTA		PART 6 BRACKET	
		No . 3F	A4

1 2 3 4 5 6

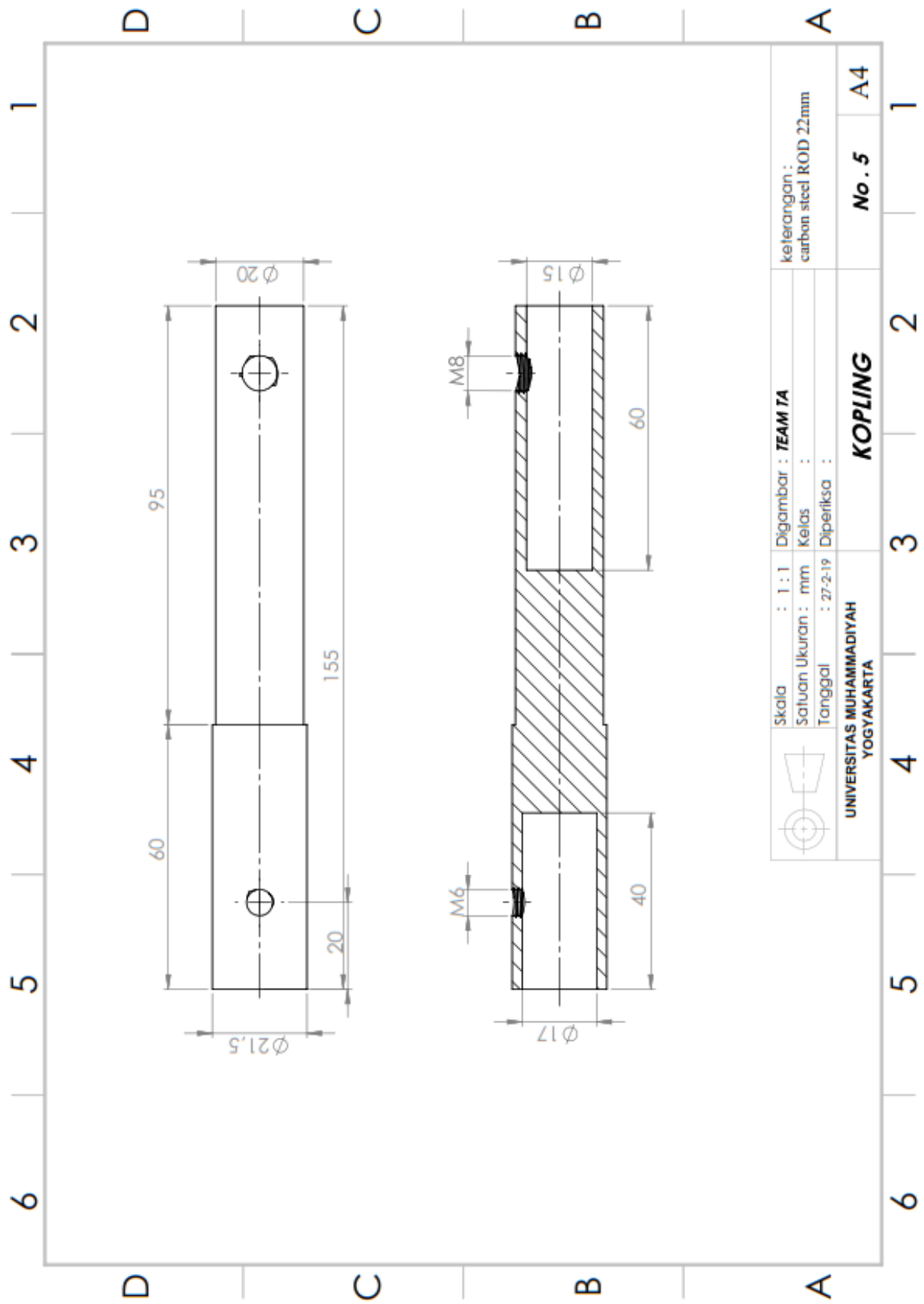

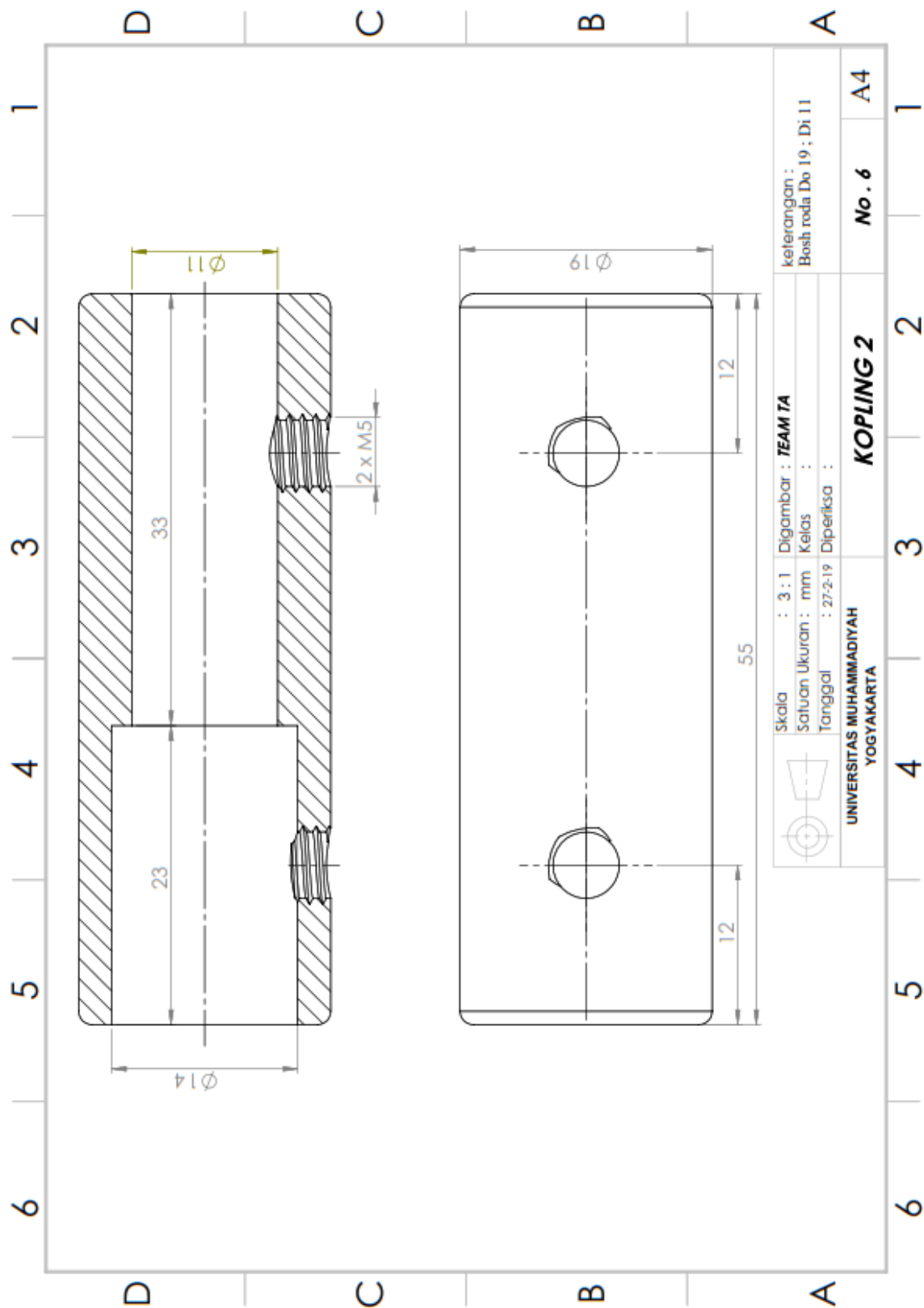

	Skala : 3 : 1	Digambar : TEAM TA	Keterangan : Bosh roda Do 19 ; Di 11
	Satuan Ukuran : mm	Kelas :	
	Tanggal : 27-2-19	Diperiksa :	
UNIVERSITAS MUHAMMADIYAH YOGYAKARTA		KOPLING 2	No . 6 A4

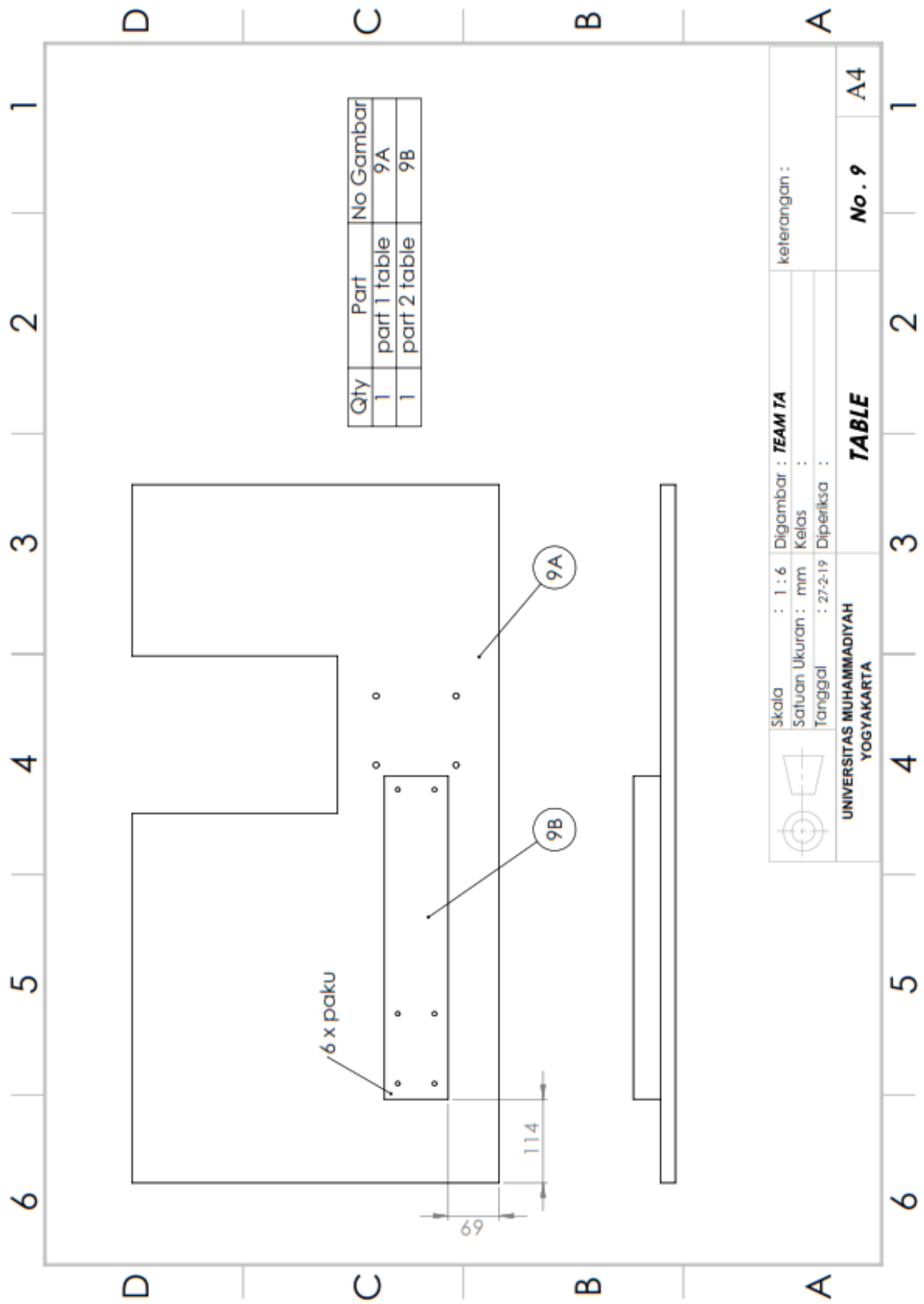

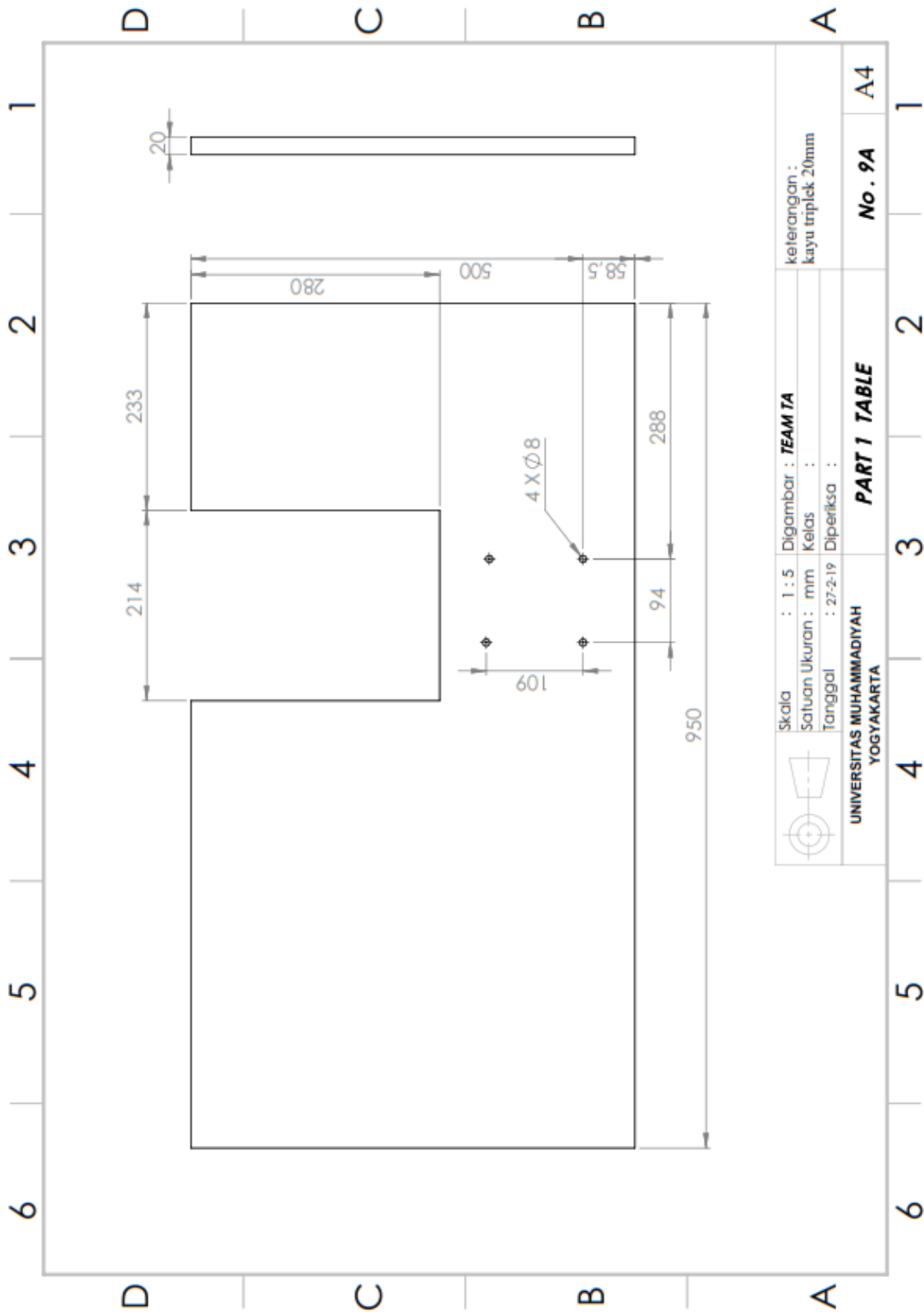

 UNIVERSITAS MUHAMMADIYAH YOGYAKARTA	Skala : 1 : 5	Digambar : TEAM TA	keterangan : kayu triplek 20mm
	Satuan Ukuran : mm	Kelas :	
	Tanggal : 27-2-19	Diperiksa :	
PART 1 TABLE		No. 9A	A4

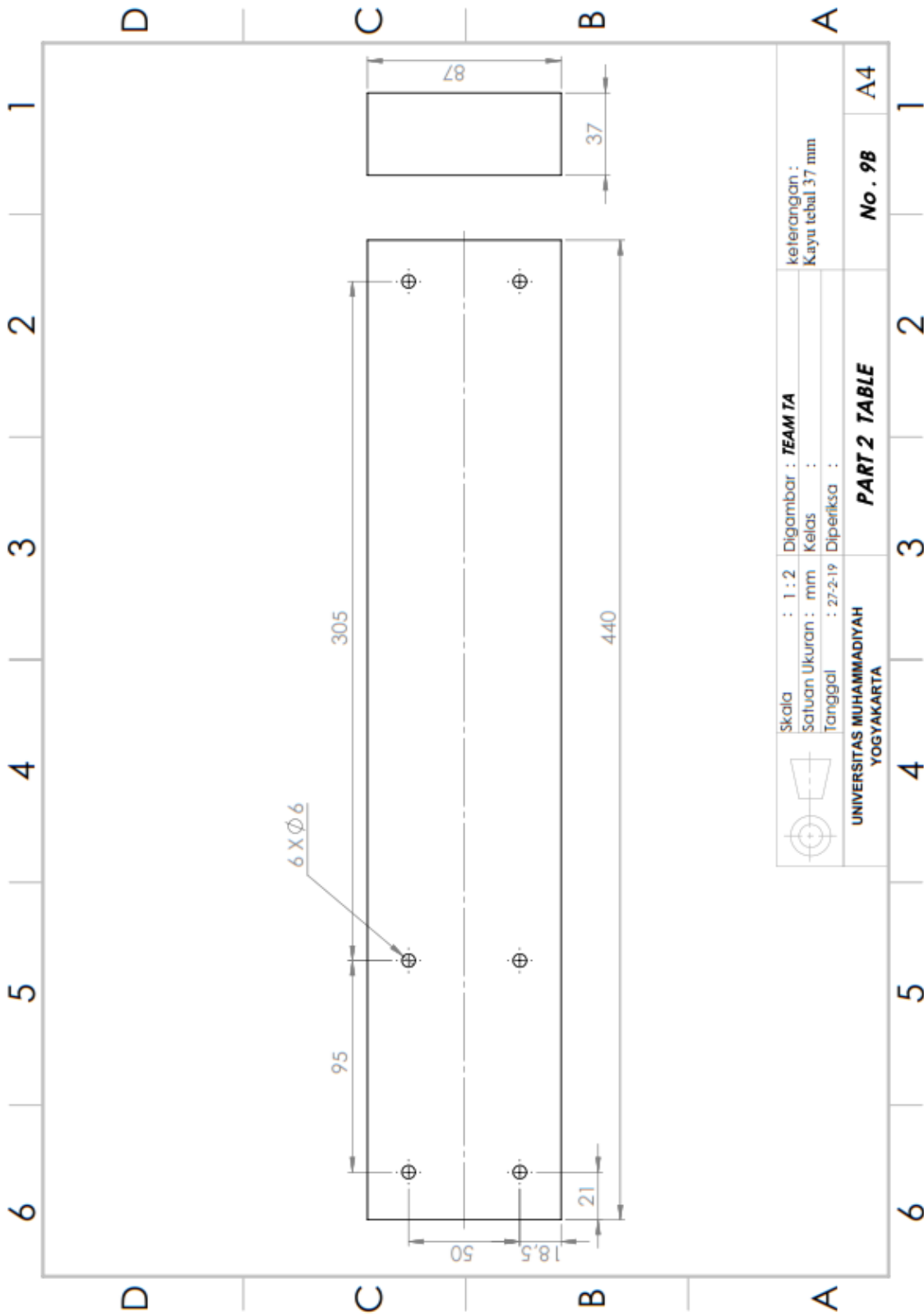

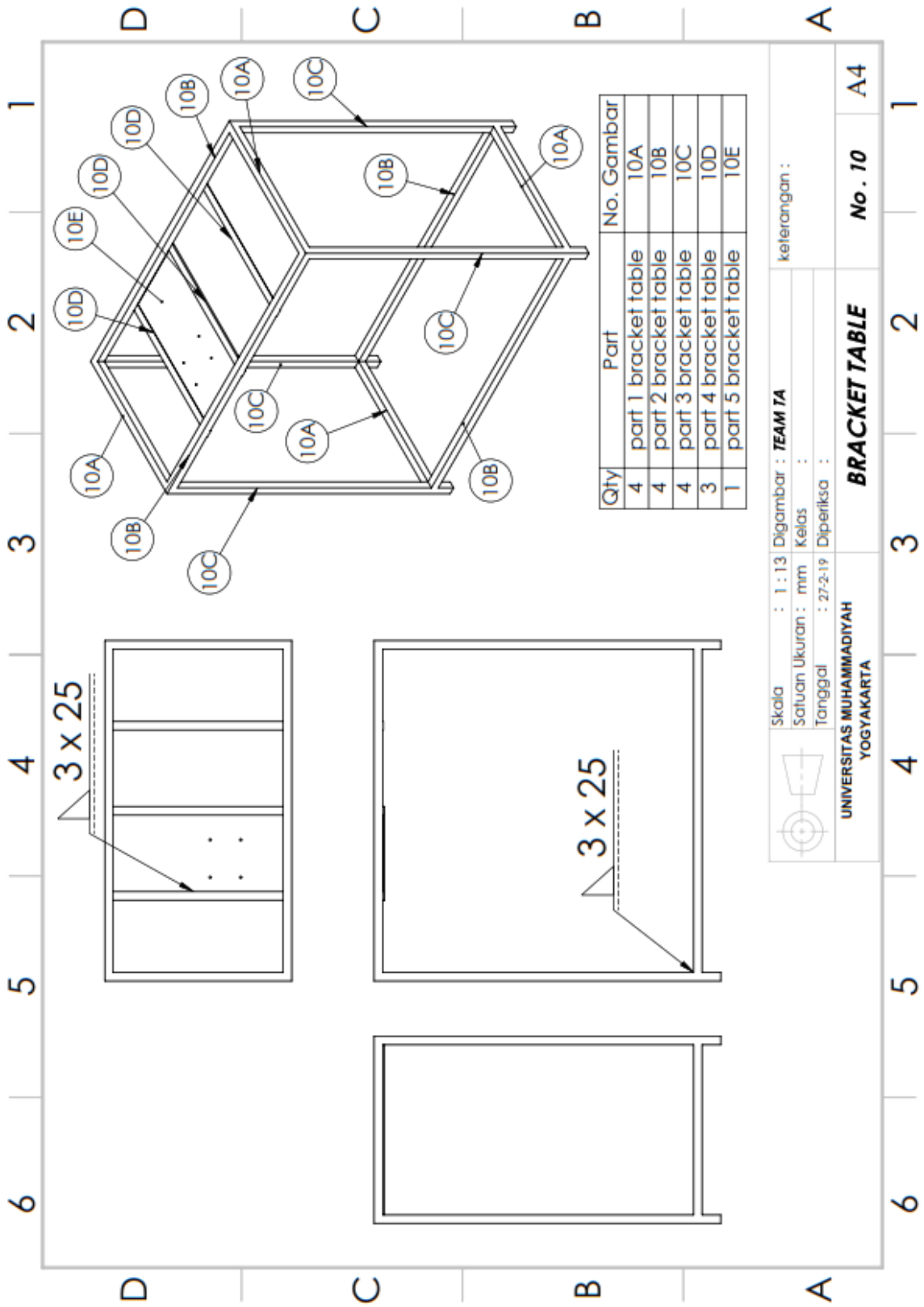

Qty	Part	No. Gambar
4	part 1 bracket table	10A
4	part 2 bracket table	10B
4	part 3 bracket table	10C
3	part 4 bracket table	10D
1	part 5 bracket table	10E

Skala : 1 : 13 Digambar : **TEAM TA** keterangan :
 Satuan Ukuran : mm Kelas :
 Tanggal : 27-2-19 Diperiksa :

UNIVERSITAS MUHAMMADIYAH
YOGYAKARTA

BRACKET TABLE **No. 10** **A4**

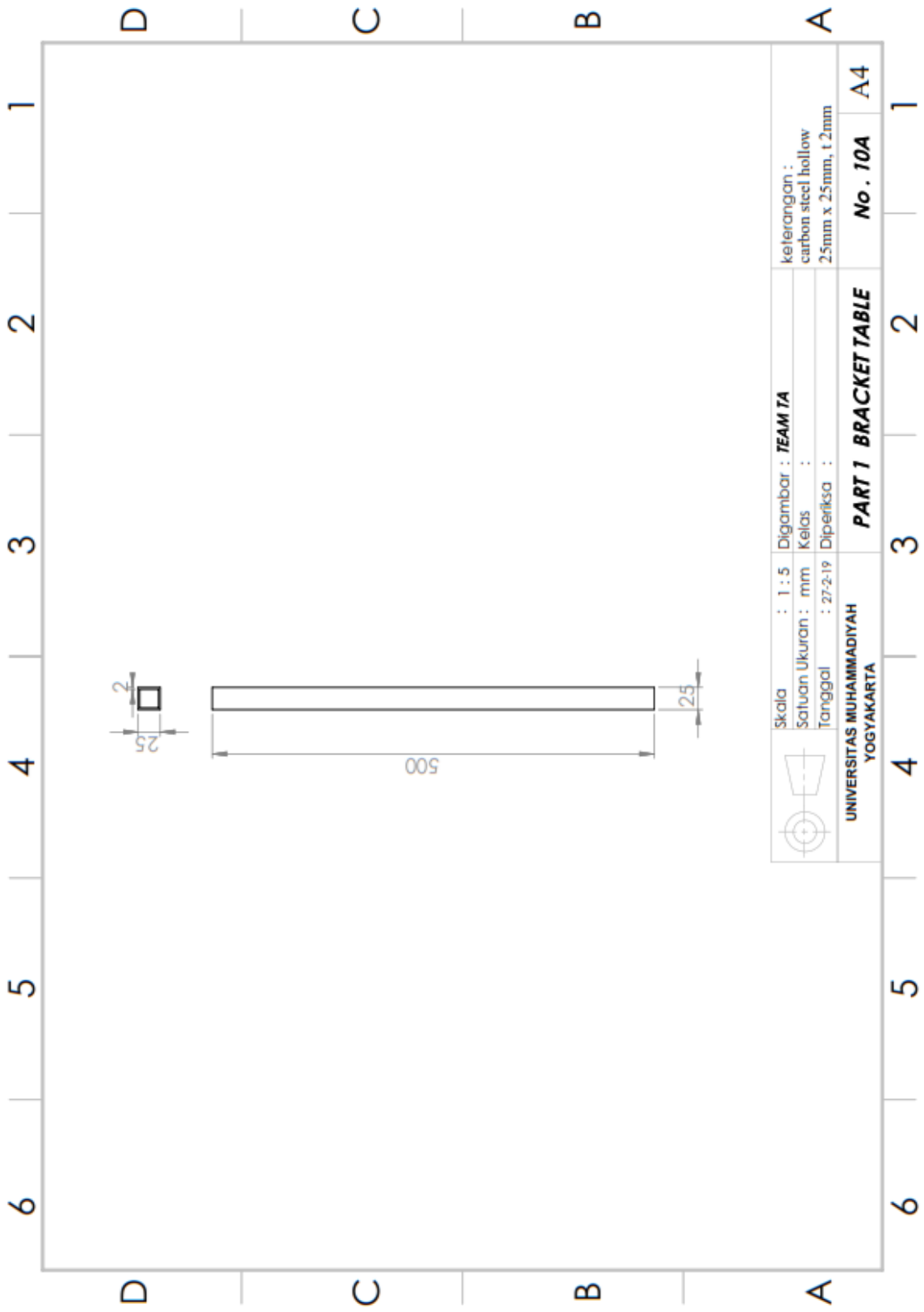

	Skala : 1 : 5	Digambar : TEAM TA	keterangan : carbon steel hollow 25mm x 25mm, t 2mm
	Satuan Ukuran : mm	Kelas :	
	Tanggal : 27-2-19	Diperiksa :	
UNIVERSITAS MUHAMMADIYAH YOGYAKARTA		PART 1 BRACKET TABLE	
		No . 10A	A4

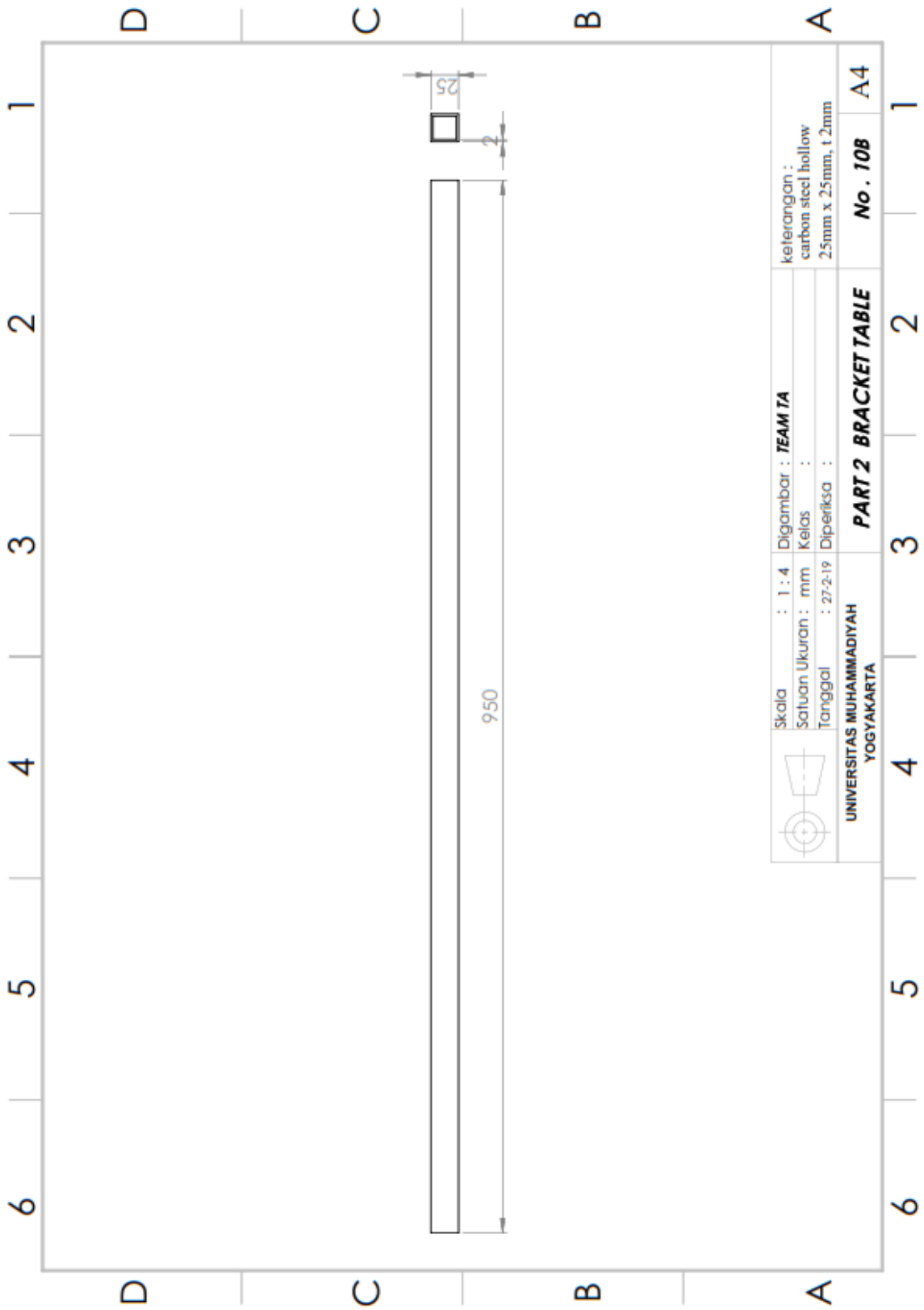

 <p>UNIVERSITAS MUHAMMADIYAH YOGYAKARTA</p>	Skala : 1 : 4	Digambar : TEAM TA	keterangan : carbon steel hollow 2.5mm x 25mm, 1.2mm
	Satuan Ukuran : mm	Kelas :	
	Tanggal : 27-2-19	Diperiksa :	
		PART 2 BRACKET TABLE	No . 10B
		4	1
		3	2
		2	3
		1	4

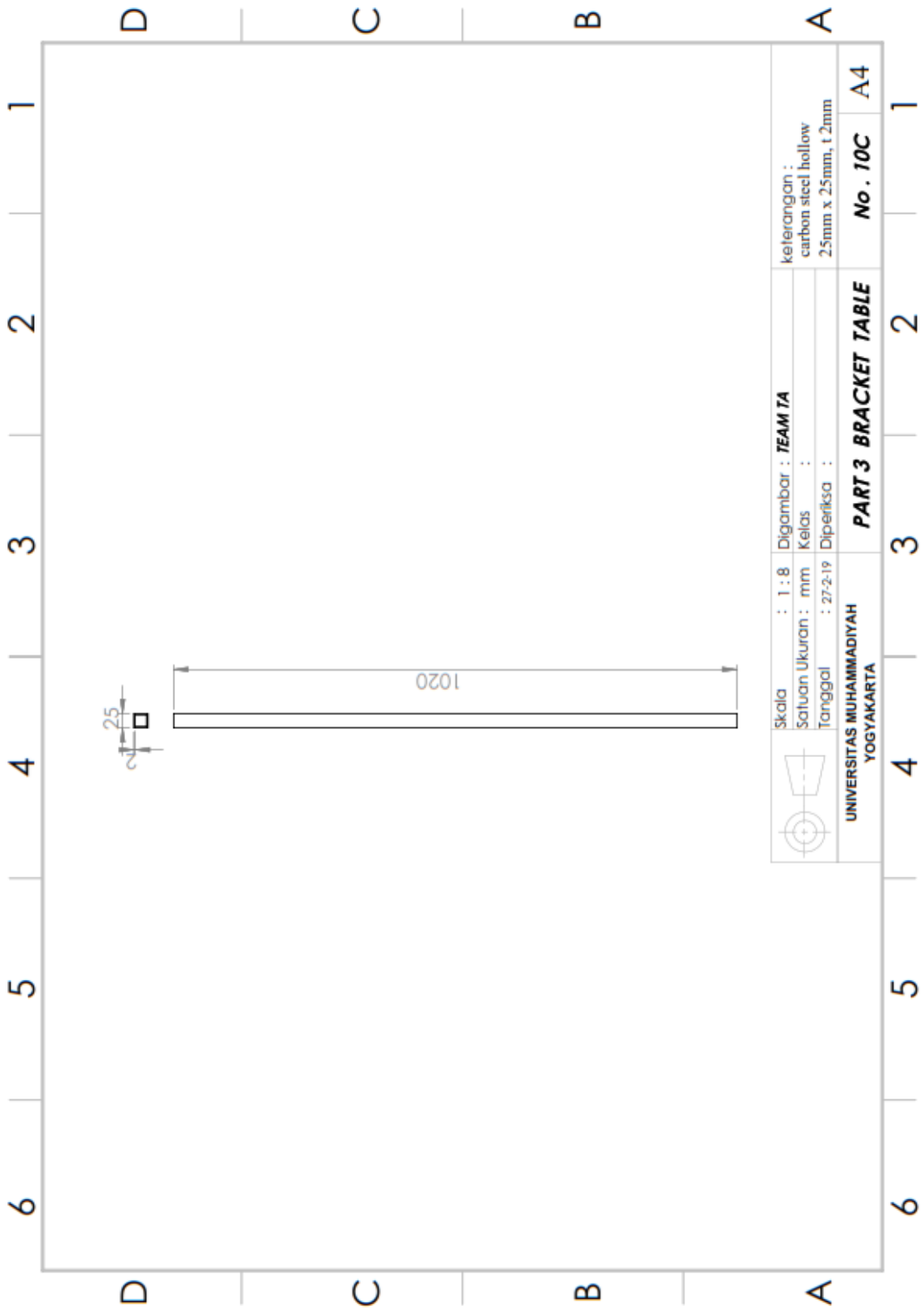

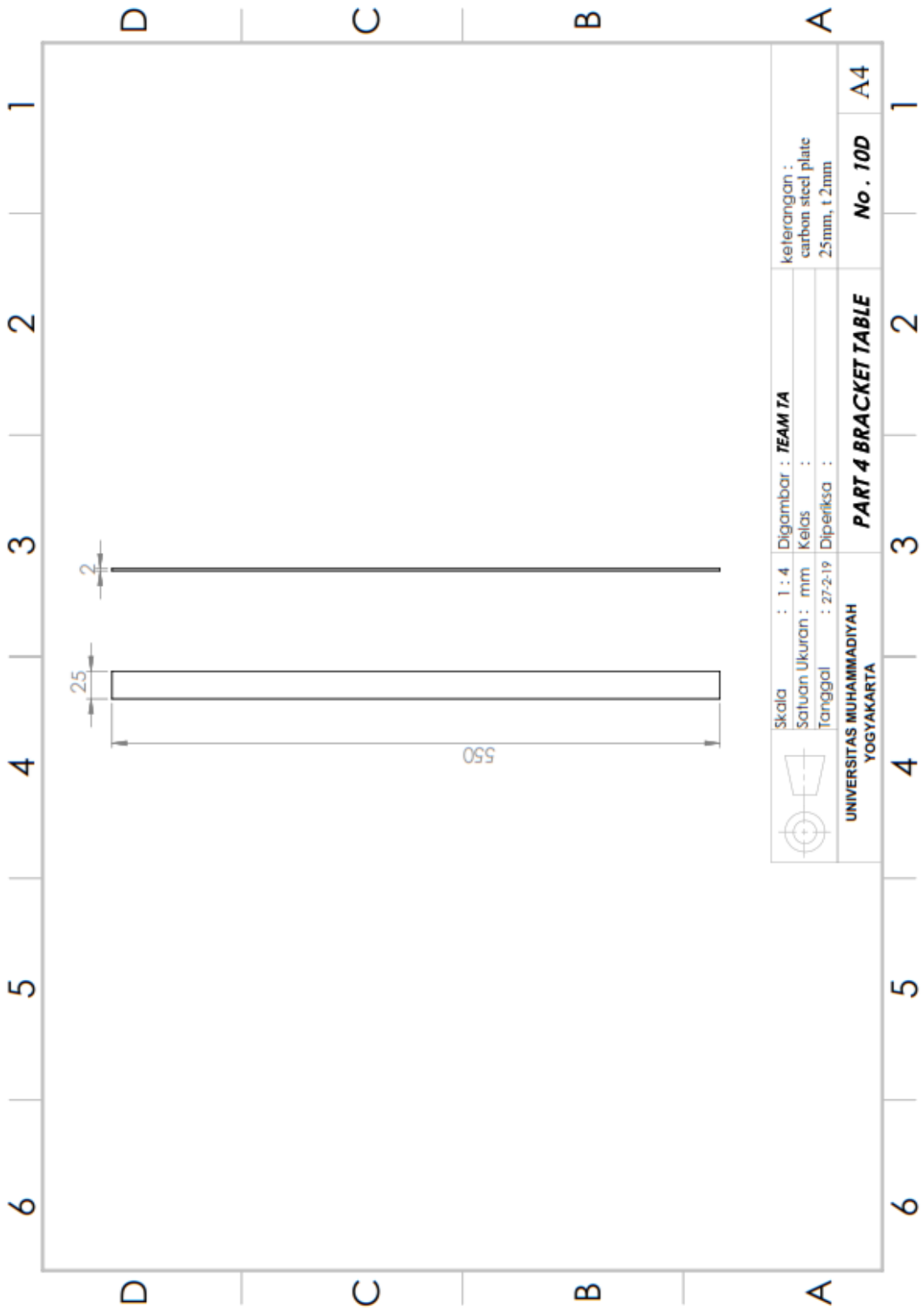

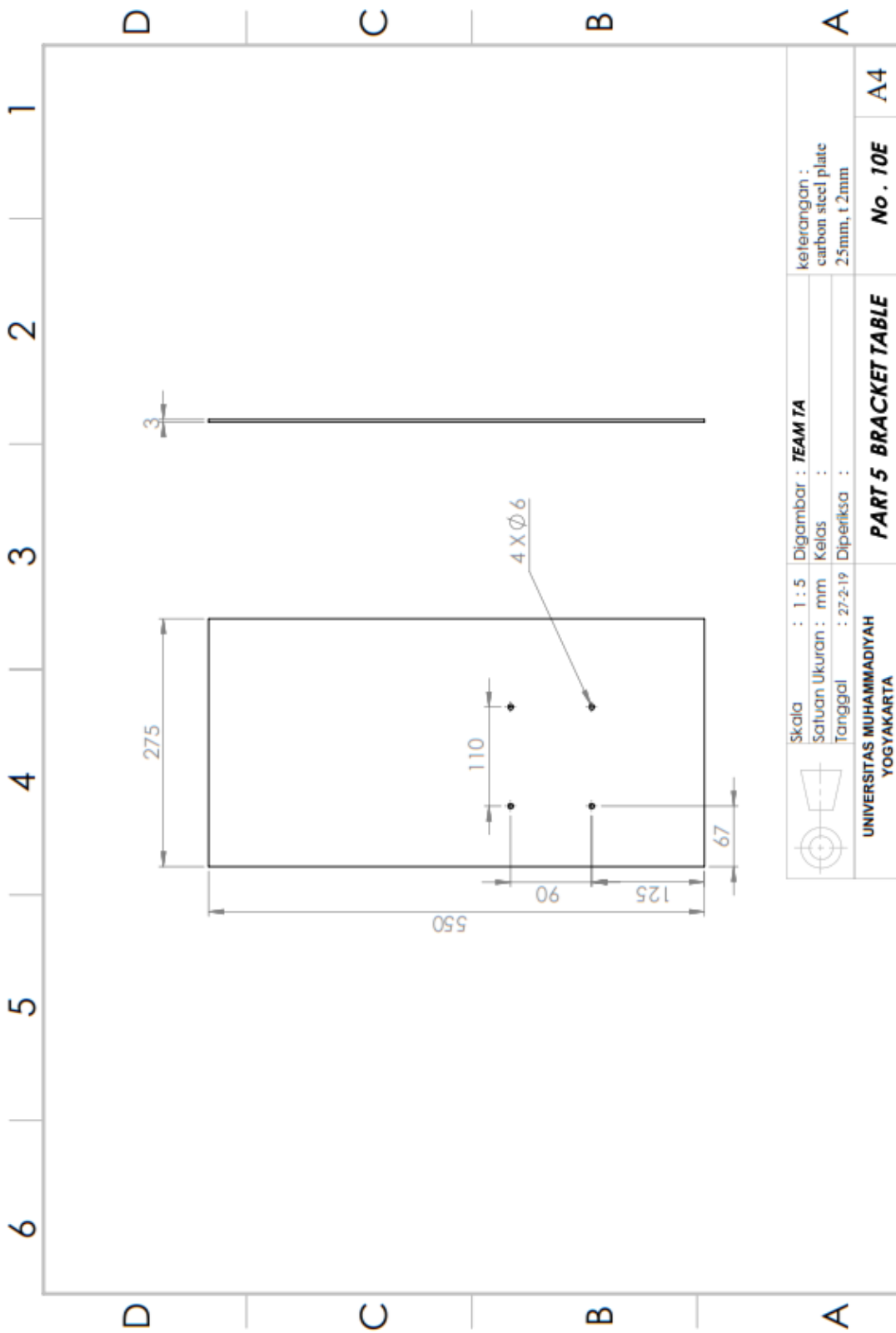

	Skala : 1 : 5	Digambar : TEAM TA	keterangan : carbon steel plate 2.5mm, t 2mm
	Satuan Ukuran : mm	Kelas :	
	Tanggal : 27-2-19	Diperiksa :	
UNIVERSITAS MUHAMMADIYAH YOGYAKARTA		PART 5 BRACKET TABLE	
			No . 10E
			A4

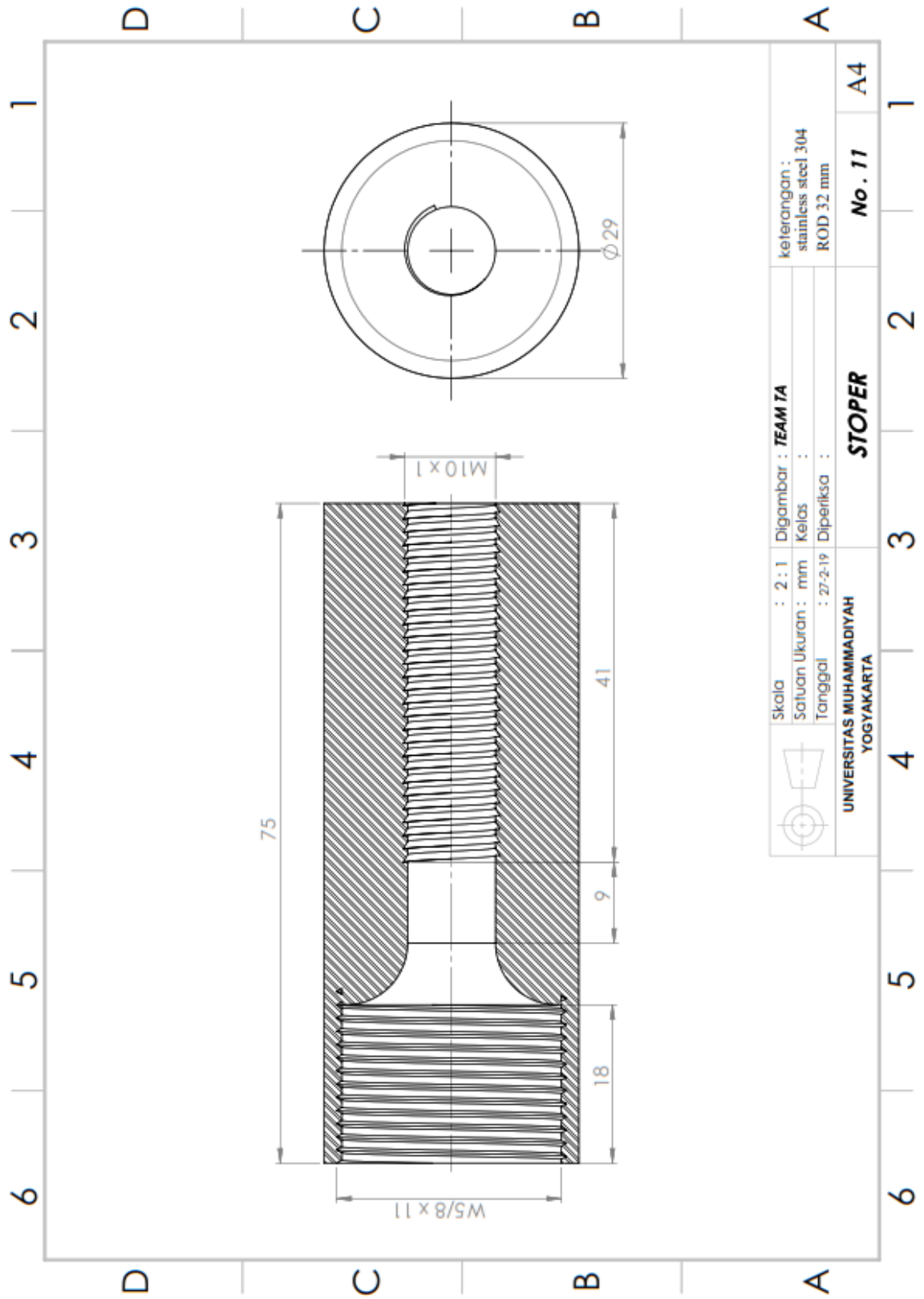

	Skala : 2 : 1	Digambar : TEAM TA	Keterangan : stainless steel 304 ROD 32 mm
	Satuan Ukuran : mm	Kelas	
	Tanggal : 27-2-19	Diperiksa :	
UNIVERSITAS MUHAMMADIYAH YOGYAKARTA			No . 11 A4

1 2 3 4 5 6 1 2 3 4 5 6

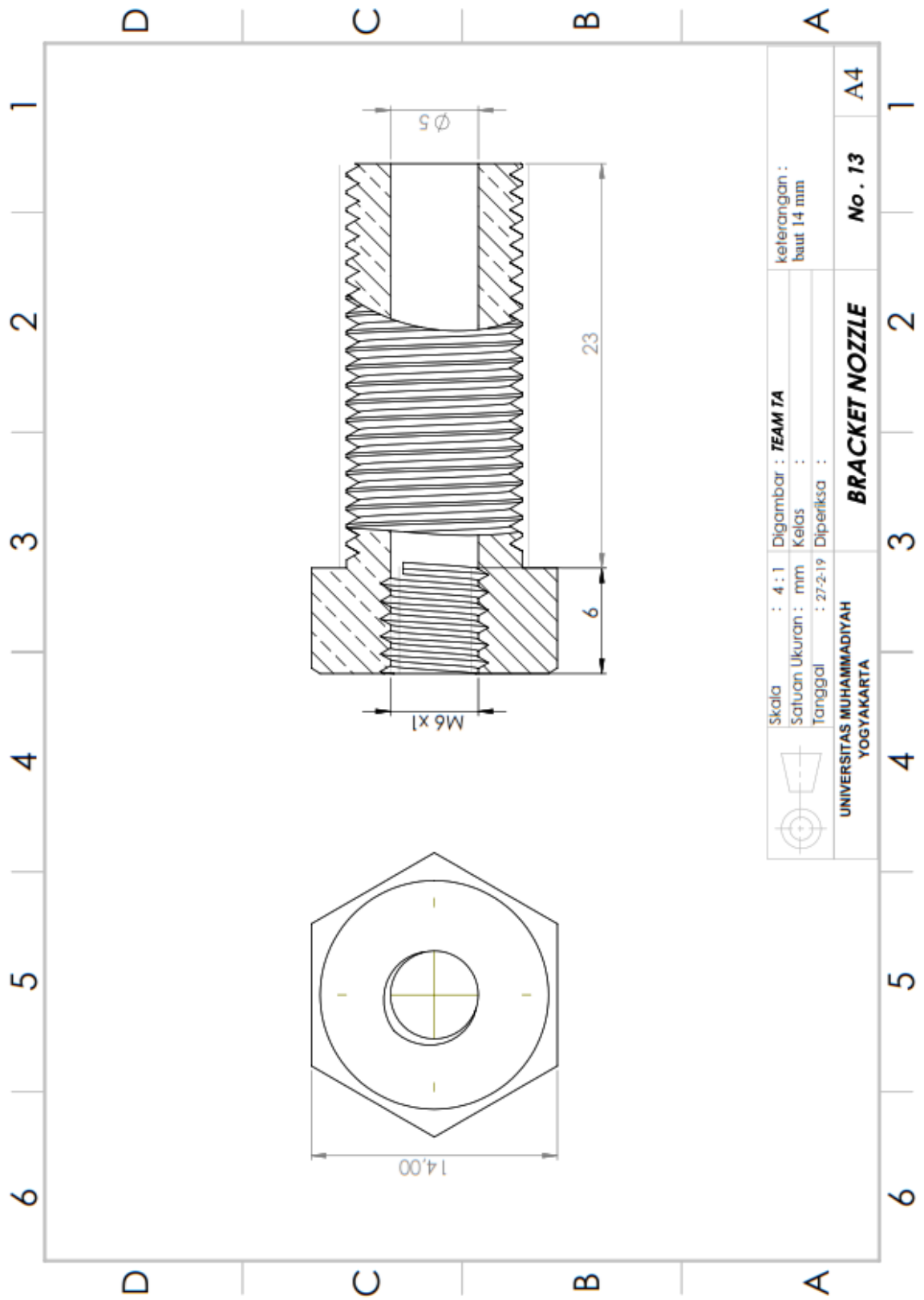

 UNIVERSITAS MUHAMMADIYAH YOGYAKARTA	Skala : 4 : 1	Digambar : TEAM TA	keterangan :
	Satuan Ukuran : mm	Kelas :	baut 14 mm
	Tanggal : 27-2-19	Diperiksa :	
BRACKET NOZZLE			No. 13
			A4

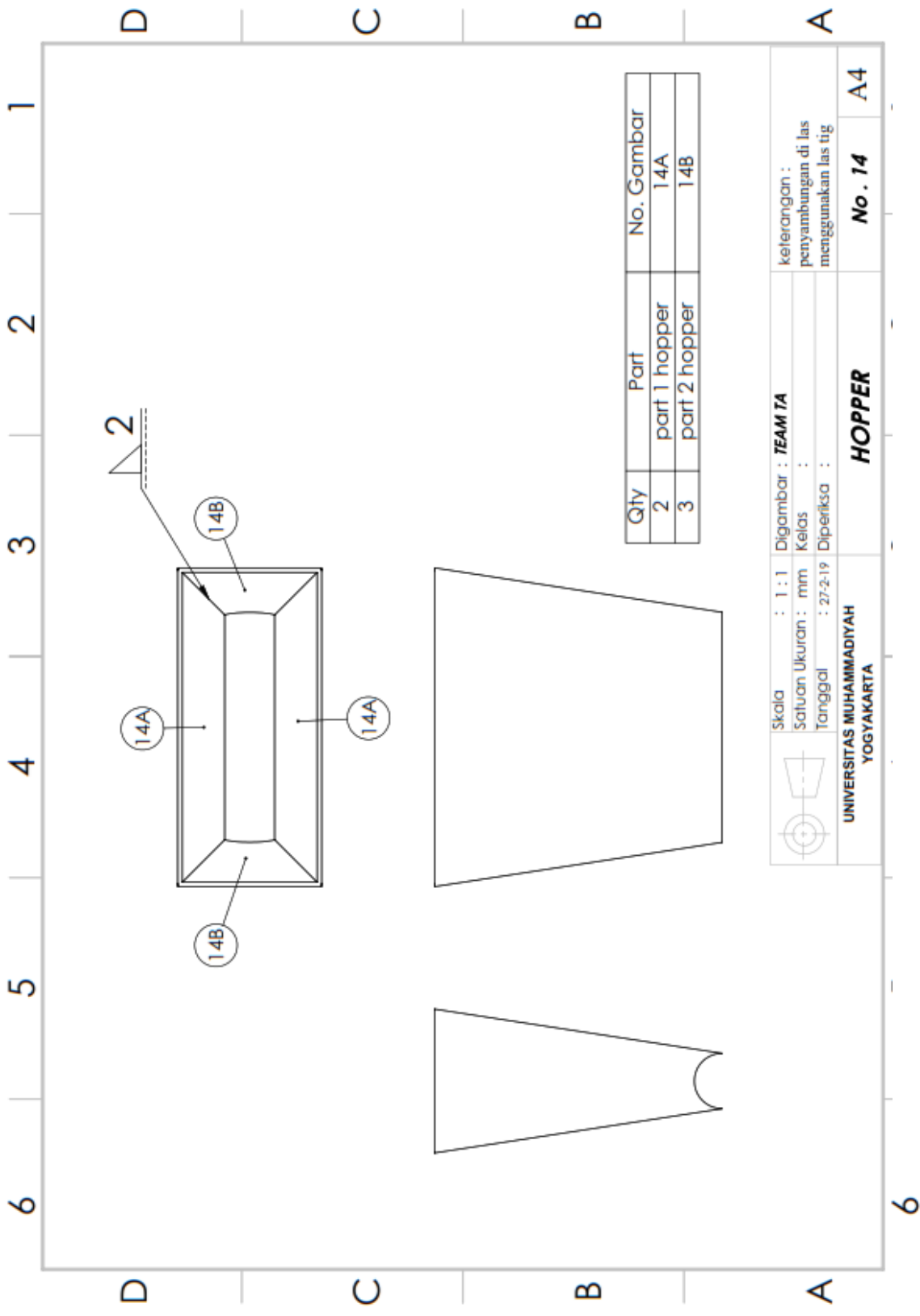

Qty	Part	No. Gambar
2	part 1 hopper	14A
3	part 2 hopper	14B

	Skala : 1 : 1	Digambar : TEAM TA	keterangan : penyambungan di las menggunakan las tig
	Satuan Ukuran : mm	Kelas :	
	Tanggal : 27-2-19	Diperiksa :	
UNIVERSITAS MUHAMMADIYAH YOGYAKARTA		HOPPER	No. 14
			A4

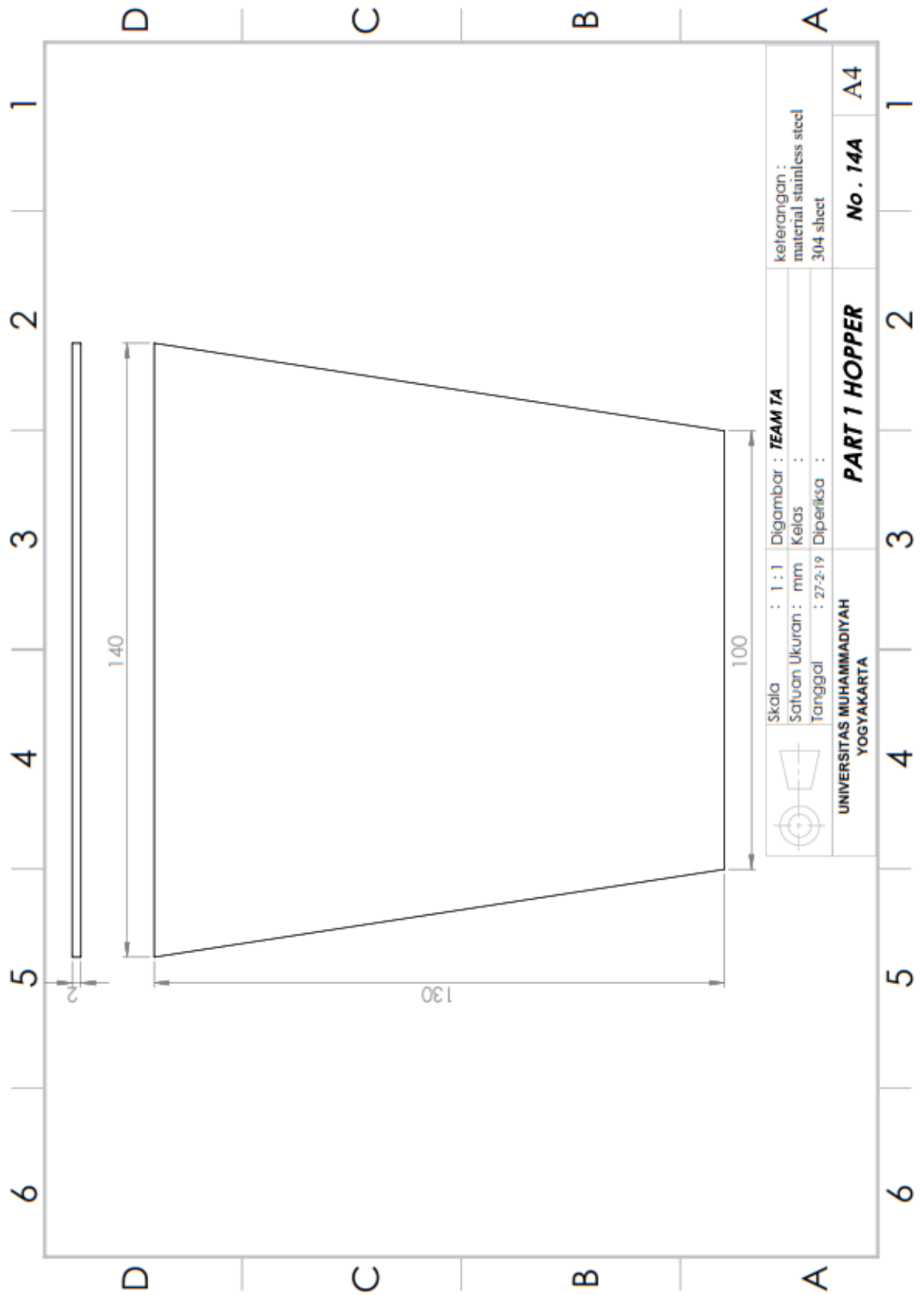

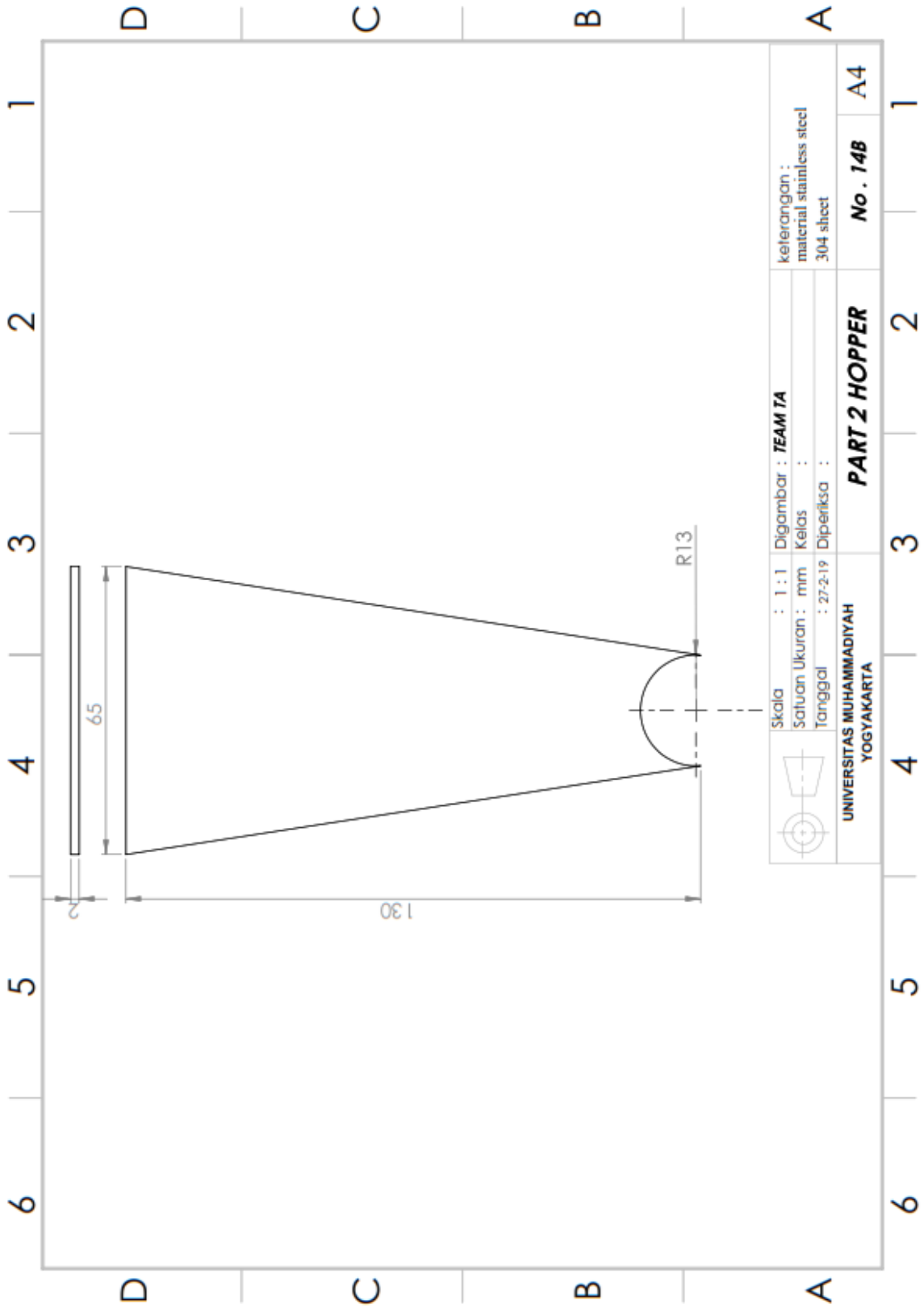

	Skala : 1 : 1	Digambar : TEAM TA	keterangan : material stainless steel 304 sheet
	Satuan Ukuran : mm	Kelas :	
	Tanggal : 27-2-19	Diperiksa :	
UNIVERSITAS MUHAMMADIYAH YOGYAKARTA		PART 2 HOPPER	No. 14B A4

6 5 4 3 2 1

A B C D

1 2 3 4 5 6

